

ESSENTIALS



ROITT'S ESSENTIAL IMMUNOLOGY

PETER J. DELVES | SEAMUS J. MARTIN
DENNIS R. BURTON | IVAN M. ROITT

THIRTEENTH EDITION



www.myuptodate.com

with website



WILEY Blackwell

راهنمای نصب آخرین نسخه آپتودیت آفلاین

۱. برای نصب اپلیکشین در گوشی آیفون، برنامه App Store و در گوشی اندروید Play Store را اجرا کرده سپس عبارت Mehrsys medical library را جستجو کنید و برنامه را نصب کنید.

۲. بعد از نصب و اجرای اپلیکیشن در صفحه اول برنامه برای دریافت Username و Password به تلگرام پشتیبانی و فروش که در زیر تصویر اشاره شده است پیغام دهید.

@MehrsysSupport

۳. در مرحله بعد حساب کاربری خود را بسازید.

۴. بعد از ورود به برنامه در قسمت یا منوی Download روی آیکون سه نقطه آبی رنگ که رو به روی UpToDate قرار دارد کلیک کنید و گزینه دانلود Download را انتخاب کنید با این عمل می توانید دانلود را به آسانی از طریق اینترنت انجام دهید.

قابلیتهای برنامه

- دسترسی به آخرین نسخه آپتودیت آفلاین با قابلیت بروز رسانی
- امکان جستجو بسیار سریع مطالب بدون نیاز به اینترنت
- امکان مشاهده **abstract** رفرنسهای داخل مقالات آپتودیت
- قابل نصب بر روی گوشی و کامپیوتر
- دسترسی به دیگر منابع پزشکی و دارویی به صورت رایگان
- امکان انتخاب متون، کپی و ارسال آن به برنامه های دیگر
- هایلایت کردن متون در برنامه به رنگهای مختلف
- ذخیره کردن مقالات و عکسهای آپتودیت
- تولید شده توسط شرکت معتبر نرم افزاری و مورد تایید نظام صنفی رایانه ای کشور و شورای عالی انفورماتیک



Roitt's Essential Immunology

This title is also available as an e-book.
For more details, please see
www.wiley.com/buy/9781118415771
or scan this QR code:



Thirteenth edition

Roitt's Essential Immunology

Peter J. Delves

PhD

Division of Infection and Immunity

UCL

London, UK

Seamus J. Martin

PhD, FTCD, MRIA

The Smurfit Institute of Genetics

Trinity College

Dublin, Ireland

Dennis R. Burton

PhD

Department of Immunology and Microbial Science

The Scripps Research Institute

La Jolla, California, USA

Ivan M. Roitt

MA, DSc (Oxon), FRCPath, Hon FRCP (Lond), FRS

Centre for Investigative and Diagnostic Oncology

Middlesex University

London, UK

WILEY Blackwell

This edition first published 2017 © 2017 by John Wiley and Sons, Ltd. © 1971, 1974, 1977, 1980, 1984, 1988, 1991, 1994, 1997, 2001, 2006, 2011 by Peter J. Delves, Seamus J. Martin, Dennis R. Burton, Ivan M. Roitt

Registered Office

John Wiley & Sons, Ltd, The Atrium, Southern Gate, Chichester, West Sussex, PO19 8SQ, UK

Editorial Offices

9600 Garsington Road, Oxford, OX4 2DQ, UK

The Atrium, Southern Gate, Chichester, West Sussex, PO19 8SQ, UK

For details of our global editorial offices, for customer services and for information about how to apply for permission to reuse the copyright material in this book please see our website at www.wiley.com/wiley-blackwell

The right of the author to be identified as the author of this work has been asserted in accordance with the UK Copyright, Designs and Patents Act 1988.

All rights reserved. No part of this publication may be reproduced, stored in a retrieval system, or transmitted, in any form or by any means, electronic, mechanical, photocopying, recording or otherwise, except as permitted by the UK Copyright, Designs and Patents Act 1988, without the prior permission of the publisher.

Designations used by companies to distinguish their products are often claimed as trademarks. All brand names and product names used in this book are trade names, service marks, trademarks or registered trademarks of their respective owners. The publisher is not associated with any product or vendor mentioned in this book. It is sold on the understanding that the publisher is not engaged in rendering professional services. If professional advice or other expert assistance is required, the services of a competent professional should be sought.

The contents of this work are intended to further general scientific research, understanding, and discussion only and are not intended and should not be relied upon as recommending or promoting a specific method, diagnosis, or treatment by health science practitioners for any particular patient. The publisher and the author make no representations or warranties with respect to the accuracy or completeness of the contents of this work and specifically disclaim all warranties, including without limitation any implied warranties of fitness for a particular purpose. In view of ongoing research, equipment modifications, changes in governmental regulations, and the constant flow of information relating to the use of medicines, equipment, and devices, the reader is urged to review and evaluate the information provided in the package insert or instructions for each medicine, equipment, or device for, among other things, any changes in the instructions or indication of usage and for added warnings and precautions. Readers should consult with a specialist where appropriate. The fact that an organization or Website is referred to in this work as a citation and/or a potential source of further information does not mean that the author or the publisher endorses the information the organization or Website may provide or recommendations it may make. Further, readers should be aware that Internet Websites listed in this work may have changed or disappeared between when this work was written and when it is read. No warranty may be created or extended by any promotional statements for this work. Neither the publisher nor the author shall be liable for any damages arising herefrom.

Library of Congress Cataloging-in-Publication Data

Names: Delves, Peter J., author. | Martin, Seamus J., 1966– author. | Burton, Dennis R., author. | Roitt, Ivan M. (Ivan Maurice), author.

Title: Roitt's essential immunology / Peter J. Delves, Seamus J. Martin, Dennis R. Burton, Ivan M. Roitt.

Other titles: Essential immunology

Description: 13th edition. | Chichester, West Sussex ; Hoboken, [NJ] : John Wiley & Sons, Inc., 2017. |

Preceded by Roitt's essential immunology / Peter J. Delves ... [et al.]. 12th ed. 2011. |

Includes bibliographical references and index.

Identifiers: LCCN 2016022210 (print) | LCCN 2016022856 (ebook) | ISBN 9781118415771 (pbk.) | ISBN 9781118416068 (pdf) | ISBN 9781118416044 (epub)

Subjects: | MESH: Immune System | Immunity

Classification: LCC QR181 (print) | LCC QR181 (ebook) | NLM QW 504 | DDC 616.07/9–dc23

LC record available at <https://lcn.loc.gov/2016022210>

A catalogue record for this book is available from the British Library.

Wiley also publishes its books in a variety of electronic formats. Some content that appears in print may not be available in electronic books.

Cover image: ©Getty Images / Science Photo Library - STEVE GSCHMEISSNER

Set in 10/12pt Adobe Garamond by SPi Global, Pondicherry, India

Contents

About the authors	vi
Acknowledgments	viii
Preface	ix
Abbreviations	x
How to use your textbook	xvi
About the companion website	xvii
Part 1: Fundamentals of immunology	1
1 Innate immunity	3
2 Specific acquired immunity	52
3 Antibodies	69
4 Membrane receptors for antigen	97
5 Antigen-specific recognition	139
6 The anatomy of the immune response	167
7 Lymphocyte activation	187
8 The production of effectors	218
9 The regulation of the immune response	272
10 Development and evolution of the immune response	291
Part 2: Applied immunology	319
11 Adversarial strategies during infection	321
12 Vaccines	353
13 Immunodeficiency	378
14 Allergy and other hypersensitivities	405
15 Transplantation	435
16 Tumor immunology	458
17 Autoimmune diseases	499
Glossary	529
Index	541

Don't forget to visit the companion website for this book:



www.roitt.com

About the authors

Peter J. Delves

Professor Delves obtained his PhD from the University of London in 1986 and is a Professor of Immunology at UCL (University College London). His research has focused on molecular aspects of antigen recognition. He has authored and edited a number of immunology books, and teaches the subject worldwide at a broad range of levels.



Seamus J. Martin

Professor Martin received his PhD from The National University of Ireland in 1990 and trained as a post-doctoral fellow at University College London (with Ivan Roitt) and The La Jolla Institute for Allergy and Immunology, California, USA (with Doug Green). Since 1999, he is the holder of the Smurfit Chair of Medical Genetics at Trinity College Dublin and is also a Science Foundation Ireland Principal Investigator. His research is focused on various aspects of programmed cell death (apoptosis) in the immune system and in cancer and he has received several awards for his work in this area. He has previously edited two books on apoptosis and was elected as a Member of The Royal Irish Academy in 2006 and as a member of The European Molecular Biology Organisation (EMBO) in 2009.



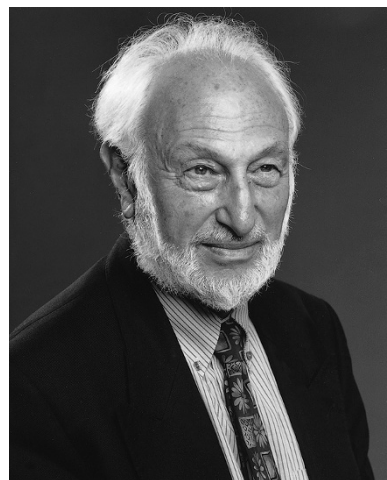
Dennis R. Burton

Professor Burton obtained his BA in Chemistry from the University of Oxford in 1974 and his PhD in Physical Biochemistry from the University of Lund in Sweden in 1978. After a period at the University of Sheffield, he moved to the Scripps Research Institute in La Jolla, California in 1989 where he is Professor of Immunology and Microbial Science. His research interests include antibodies, antibody responses to pathogens and rational vaccine design, particularly in relation to HIV.



Ivan M. Roitt

Professor Roitt was born in 1927 and educated at King Edward's School, Birmingham and Balliol College, Oxford. In 1956, together with Deborah Doniach and Peter Campbell, he made the classic discovery of thyroglobulin autoantibodies in Hashimoto's thyroiditis which helped to open the whole concept of a relationship between autoimmunity and human disease. The work was extended to an intensive study of autoimmune phenomena in pernicious anaemia and primary biliary cirrhosis. In 1983 he was elected a Fellow of The Royal Society, and has been elected to Honorary Membership of the Royal College of Physicians and appointed Honorary Fellow of The Royal Society of Medicine. His current research is focused on cancer.



Acknowledgments

Peter Delves would like to acknowledge the enormous help provided by Biljana Nikolic in the delivery of education by the UCL Division of Infection & Immunity, and the huge support of his wife Jane and children Joe, Tom, and Jess.

Dennis Burton acknowledges funding for his research from the NIH, the Bill and Melinda Gates Foundation, the International AIDS Vaccine Initiative and the Ragon Institute of MGH, MIT and Harvard. I also thank my wife Carole and children Damian, Scott, and Julia for their support.

Ivan Roitt is eternally grateful to his wife Margaret and PA Christine and the uncontrolled events in his body which have sustained his mojo!

Preface

Greetings, dear reader! In the exciting world of scientific progress, immunology plays a prominent role and we have aimed to bring this edition to the cutting edge of the latest discoveries. Highlights of the new updates include:

- Tailoring of the adaptive immune response to pathogens, particularly in the skin by pattern recognition receptors
- New insights into the interaction between antibodies and Fc receptors, and immunoglobulin genetics
- Epigenetic control of T-cell activation
- T-cell recognition of lipid antigens and beautiful high-resolution images of interactions with other cells of the immune system
- Expanded discussion of novel events in cytokine biology
- Revised section on antibody interaction with viral proteins
- Recent developments in vaccinology including RNA vaccines
- Induction of cells suppressing a protective immune response by tumors, and recent breakthroughs in tumor immunotherapy
- Induction and maintenance of immunosuppression to curb graft rejection
- The role of inflammasomes in autoinflammatory disease
... and much more!

We try to maintain the chatty style characteristic of all earlier editions, imagining that you and the authors are on either side of a fireplace discussing the issues informally, which we hope makes the process of assimilation less painful and quite probably enjoyable.

Peter J. Delves
Seamus J. Martin
Dennis R. Burton
Ivan M. Roitt

Abbreviations

AAV	adeno-associated virus
Ab	antibody
AChR	acetylcholine receptor
ACT	adoptive cell transfer
ACTH	adrenocorticotrophic hormone
ADA	adenosine deaminase
ADCC	antibody-dependent cellular cytotoxicity
AEP	asparagine endopeptidase
Ag	antigen
AID	activation-induced cytidine deaminase
AIDS	acquired immunodeficiency syndrome
AIRE	autoimmune regulator
ALBA	addressable laser bead assay
ANCA	antineutrophil cytoplasmic antibodies
APC	antigen-presenting cell
ARRE-1	antigen receptor response element-1
ARRE-2	antigen receptor response element-2
ART	antiretroviral therapy
ASFV	African swine fever virus
AZT	zidovudine (3'-azido-3'-deoxythymidine)
BAFF	B-cell-activating factor of the tumor necrosis factor family
B-cell	lymphocyte which matures in bone marrow
BCG	bacille Calmette–Guérin attenuated form of tuberculosis
BCR	B-cell receptor
BM	bone marrow
BSA	bovine serum albumin
BSE	bovine spongiform encephalopathy
Btk	Bruton's tyrosine kinase
BUDR	bromodeoxyuridine
C	complement
C α ($\beta/\gamma/\delta$)	constant part of TCR α ($\beta/\gamma/\delta$) chain
CALLA	common acute lymphoblastic leukemia antigen
cAMP	cyclic adenosine monophosphate
CCP	complement control protein repeat
CD	cluster of differentiation
CDR	complementarity determining regions of Ig or TCR variable portion
CEA	carcinoembryonic antigen
CFA	complete Freund's adjuvant
cGMP	cyclic guanosine monophosphate
ChIP	chromatin immunoprecipitation
CHIP	chemotaxis inhibitory protein
C _{H(L)}	constant part of Ig heavy (light) chain
CLA	cutaneous lymphocyte antigen
CLIP	class II-associated invariant chain peptide
CMI	cell-mediated immunity
CML	cell-mediated lympholysis
CMV	cytomegalovirus
C _n	complement component "n"
C \bar{n}	activated complement component "n"
iC _n	inactivated complement component "n"
C _{na}	small peptide derived by proteolytic activation of C _n

CpG	cytosine phosphate-guanosine dinucleotide motif
CR(n)	complement receptor “n”
CRP	C-reactive protein
CSF	cerebrospinal fluid
CSR	class switch recombination
CTLR	C-type lectin receptor
DAF	decay accelerating factor
DAG	diacylglycerol
DAMP	danger-associated molecular pattern
DC	dendritic cells
<i>D</i> gene	diversity minigene joining <i>V</i> and <i>J</i> segments to form variable region
DMARD	disease-modifying antirheumatic drug
DNP	dinitrophenyl
DTH	delayed-type hypersensitivity
DTP	diphtheria, tetanus, pertussis triple vaccine
EAE	experimental autoimmune (allergic) encephalomyelitis
EBV	Epstein–Barr virus
ELISA	enzyme-linked immunosorbent assay
EM	electron microscope
E ϕ	eosinophil
EPO	erythropoietin
ER	endoplasmic reticulum
ES	embryonic stem (cell)
ET	exfoliative toxins
F(B)	factor (B, etc.)
Fab	monovalent Ig antigen-binding fragment after papain digestion
F(ab') ₂	divalent antigen-binding fragment after pepsin digestion
FACS	fluorescence-activated cell sorter
FasL	Fas-ligand
Fc	Ig crystallizable-fragment originally; now non-Fab part of Ig
Fc γ R	receptor for IgG Fc fragment
FDC	follicular dendritic cell
flt-3	flt-2 ligand
(sc)Fv	(single chain) V _H –V _L antigen binding fragment
GADS	GRB2-related adaptor protein
g.b.m.	glomerular basement membrane
G-CSF	granulocyte colony-stimulating factor
GEFs	guanine-nucleotide exchange factors
GM-CSF	granulocyte–macrophage colony-stimulating factor
gp n	<i>n</i> kDa glycoprotein
GRB2	growth factor receptor-binding protein 2
GSK3	glycogen synthase kinase 3
GVH	graft versus host
H-2	the mouse major histocompatibility complex
H-2D/K/L(A/E)	main loci for classical class I (class II) murine MHC molecules
HAMA	human antimouse antibodies
HATA	human antitoxin antibody
HBsAg	hepatitis B surface antigen
hCG	human chorionic gonadotropin
HCMV	human cytomegalovirus
HEL	hen egg lysozyme
HEV	high-walled endothelium of postcapillary venule
HIV	human immunodeficiency virus
HLA	human major histocompatibility complex
HLA-A/B/C(DP/DQ/DR)	main loci for classical class I (class II) human MHC molecules

HMG	high mobility group
HR	hypersensitive response
HRF	homologous restriction factor
HSA	heat-stable antigen
HSC	hematopoietic stem cell
hsp	heat-shock protein
5HT	5-hydroxytryptamine
HTLV	human T-cell leukemia virus
H-Y	male transplantation antigen
IBD	inflammatory bowel disease
ICAM-1	intercellular adhesion molecule-1
Id (α Id)	idiotype (anti-idiotype)
IDC	interdigitating dendritic cells
IDDM	insulin-dependent diabetes mellitus
IDO	indoleamine 2,3-dioxygenase
IEL	intraepithelial lymphocyte
IFN α	α -interferon (also IFN β , IFN γ)
IFR	interferon-regulated factor
Ig	immunoglobulin
IgG	immunoglobulin G (also IgM, IgA, IgD, IgE)
sIg	surface immunoglobulin
Ig- α /Ig- β	membrane peptide chains associated with sIg B-cell receptor
IgSF	immunoglobulin superfamily
IL-1	interleukin-1 (also IL-2, IL-3, etc.)
iNOS	inducible nitric oxide synthase
IP ₃	inositol trisphosphate
ISCOM	immunostimulating complex
ITAM	immunoreceptor tyrosine-based activation motif
ITIM	immunoreceptor tyrosine-based inhibitory motif
ITP	idiopathic thrombocytopenic purpura
IVIg	intravenous immunoglobulin
JAK	Janus kinases
J chain	polypeptide chain in IgA dimer and IgM pentamer
J gene	joining gene linking V or D segment to constant region
Ka(d)	association (dissociation) affinity constant (usually Ag-Ab reactions)
kDa	units of molecular mass in kilodaltons
KIR	killer immunoglobulin-like receptors
KLH	keyhole limpet hemocyanin
LAK	lymphokine-activated killer cell
LAMP	lysosomal-associated membrane proteins
LAT	linker for activation of T-cells
LATS	long-acting thyroid stimulator
LBP	LPS-binding protein
LCM	lymphocytic choriomeningitis virus
Le ^{a/b/x}	Lewis ^{a/b/x} blood group antigens
LFA-1	lymphocyte function-associated antigen-1
LGL	large granular lymphocyte
LHRH	luteinizing hormone releasing hormone
LIF	leukemia inhibiting factor
LPS	lipopolysaccharide (endotoxin)
LRR	leucine-rich repeat
LT(B)	leukotriene (B etc.)
mAb	monoclonal antibody
MAC	membrane attack complex
MAdCAM	mucosal addressin cell adhesion molecule

MALT	mucosa-associated lymphoid tissue
MAM	<i>Mycoplasma arthritidis</i> mitogen
MAP kinase	mitogen-activated protein kinase
MAPKKK	mitogen-associated protein kinase kinase kinase
MBL	mannose binding lectin
MBP	major basic protein of eosinophils (also myelin basic protein)
MCP	membrane cofactor protein (complement regulation)
MCP-1	monocyte chemotactic protein-1
M-CSF	macrophage colony-stimulating factor
MDP	muramyl dipeptide
MHC	major histocompatibility complex
MICA	MHC class I chain-related A chain
MIDAS	metal ion-dependent adhesion site
MIF	macrophage migration inhibitory factor
MIIC	MHC class II-enriched compartments
MLA	monophosphoryl lipid A
MLR	mixed lymphocyte reaction
MMTV	mouse mammary tumor virus
Mφ	macrophage
MRSA	methicillin-resistant <i>Staphylococcus aureus</i>
MS	multiple sclerosis
MSC	mesenchymal stem cell
MSH	melanocyte stimulating hormone
MTP	microsomal triglyceride-transfer protein
MuLV	murine leukemia virus
NADP	nicotinamide adenine dinucleotide phosphate
NAP	neutrophil activating peptide
NBT	nitroblue tetrazolium
NCF	neutrophil chemotactic factor
NFAT	nuclear factor of activated T-cells
NFκB	nuclear transcription factor
NK	natural killer cell
NLR	NOD-like receptor
NO	nitric oxide
NOD	nonobese diabetic mouse
NZB	New Zealand Black mouse
NZB × W	New Zealand Black mouse × NZ White F1 hybrid
·O ₂ ⁻	superoxide anion
OD	optical density
ORF	open reading frame
OS	obese strain chicken
Ova	ovalbumin
PAF(-R)	platelet activating factor (-receptor)
PAGE	polyacrylamide gel electrophoresis
PAMP	pathogen-associated molecular pattern
PBSCs	peripheral blood stem cells
PCA	passive cutaneous anaphylaxis
PCR	polymerase chain reaction
PERV	porcine endogenous retroviruses
PG(E)	prostaglandin (E etc.)
PHA	phytohemagglutinin
phox	phagocyte oxidase
PI3K	phosphatidylinositol 3-kinase
PIAS	protein inhibitor of activated STAT
pIgR	poly-Ig receptor

PIP ₂	phosphatidylinositol diphosphate
PKC	protein kinase C
PKR	RNA-dependent protein kinase
PLC	phospholipase C
PLC γ 2	phospholipase C γ 2
PMN	polymorphonuclear neutrophil
PMT	photomultiplier tube
PNH	paroxysmal nocturnal hemoglobinuria
PPAR	peroxisome proliferator-activated receptor
PPD	purified protein derivative from <i>Mycobacterium tuberculosis</i>
PRR	pattern recognition receptor
PTFE	polytetrafluoroethylene
PTK	protein tyrosine kinase
PWM	pokeweed mitogen
RA	rheumatoid arthritis
RANTES	regulated upon activation normal T-cell expressed and secreted chemokine
RAST	radioallergosorbent test
RF	rheumatoid factor
Rh(D)	rhesus blood group (D)
RIP	rat insulin promoter
RLR	RIG-like helicase receptor
RNAi	RNA interference
ROI	reactive oxygen intermediates
RSS	recombination signal sequence
SAP	serum amyloid P
SAP	sphingolipid activator protein
SAR	systemic acquired resistance
SARS	severe acute respiratory syndrome
SARS-CoV	SARS-associated coronavirus
SC	Ig secretory component
SCF	stem cell factor
scFv	single-chain variable region antibody fragment (V _H + V _L joined by a flexible linker)
SCG	sodium cromoglycate
SCID	severe combined immunodeficiency
SDF	stromal-derived factor
SDS	sodium dodecyl sulfate
SDS-PAGE	sodium dodecyl sulfate–polyacrylamide gel electrophoresis
SEA (B etc.)	<i>Staphylococcus aureus</i> enterotoxin A (B etc.)
SEREX	serological analysis of recombinant cDNA expression libraries
siRNA	short-interfering RNA
SIV	Simian immunodeficiency virus
SLE	systemic lupus erythematosus
SLIT	sublingual allergen immunotherapy
SLP-76	SH2-domain containing leukocyte protein of 76 kDa
SOCs	suppressor of cytokine signaling
SPE	streptococcal pyogenic exotoxins
SRID	single radial immunodiffusion
SSA	streptococcal superantigen
STAT	signal transducer and activator of transcription
TAC1	transmembrane activator and calcium modulator and cyclophilin ligand [CAML] interactor
T-ALL	T-acute lymphoblastic leukemia
TAP	transporter associated with antigen processing
TB	tubercle bacillus
Tc	cytotoxic T-cell

T-cell	thymus-derived lymphocyte
TCF	T-cell factor
TCR1(2)	T-cell receptor with γ/δ chains (with α/β chains)
TdT	terminal deoxynucleotidyl transferase
TG-A-L	polylysine with polyalanyl side-chains randomly tipped with tyrosine and glutamic acid
TGF β	transforming growth factor β
Th(1/2/3/9/17)	T-helper cell (subset 1, 2, 3, 9, or 17)
THF	thymic humoral factor
Thp	T-helper precursor
TLI	total lymphoid irradiation
TLR	Toll-like receptor
TM	transmembrane
TNF	tumor necrosis factor
TNP	trinitrophenol
TPO	thrombopoietin
Treg	regulatory T-cell
Ts	suppressor T-cell
TSAb	thyroid stimulating antibodies
TSE	transmissible spongiform encephalopathy
TSH(R)	thyroid stimulating hormone (receptor)
TSLP	thymic stromal lymphopoietin
TSST	toxic shock syndrome toxin
TUNEL	TdT-mediated dUTP (deoxyuridine triphosphate) nick end labeling
V $\alpha(\beta/\gamma/\delta)$	variable part of TCR $\alpha(\beta/\gamma/\delta)$ chain
VCAM	vascular cell adhesion molecule
vCJD	variant Creutzfeldt–Jakob disease
VCP	valosin-containing protein
VEGF	vascular endothelial cell growth factor
V	variable region gene for immunoglobulin or T-cell receptor
V _H	variable part of Ig heavy chain
VIMP	VCP-interacting membrane protein
VIP	vasoactive intestinal peptide
V _{kλ}	variable part of k(λ) light chain
V _L	variable part of light chain
VLA	very late antigen
VLP	virus-like particle
VNTR	variable number of tandem repeats
VP1	virus-specific peptide 1
XL	X-linked
ZAP-70	zeta chain-associated protein of 70 kDa

How to use your textbook



Features contained within your textbook

- ◀ Every chapter has its own chapter-opening page that offers a list of key topics contained within the chapter

Throughout your textbook you will find a series of icons outlining the learning features throughout the book:

Throughout your book we'll point you to related resources available on the companion website using the following icons:

Symbols

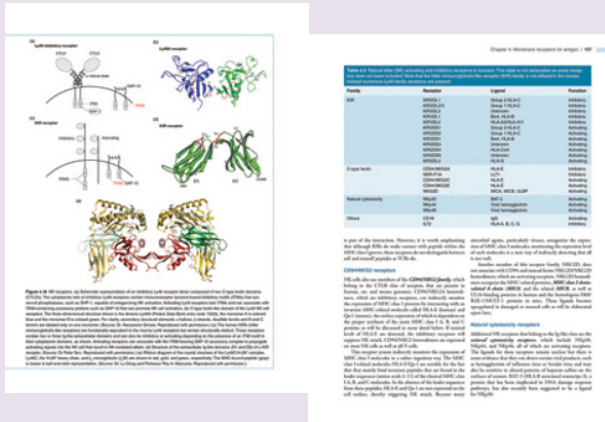
- ELS article
- Milestone
- Self test
- Video
- Podcast

Where you see the first icon, this indicates that a related article from the *Encyclopedia of Life Sciences* (ELS) is available online, giving you more information on a key topic.

Milestone boxes indicate key developments in the field.

Self-assessment multiple choice and single best answer questions and answers are available on the companion website: <http://www.roitt.com>, along with videos and animations showing key concepts.

You may also wish to use the short podcasts available online for revision, once you have read through the chapters.



- ▶ Your textbook is full of useful photographs, illustrations, and tables. ▶ The photographs and illustrations are also available to download from the companion website.

SUMMARY

Antibody recognition

- Antibodies recognize molecular shapes (epitopes) on antigens.
- Most protein epitopes are discontinuous, involving key residues from different parts of the linear sequence of the protein, although some are continuous and can be mimicked by linear peptides.
- The antibody-combining site forms a complementary surface to the epitope on the antigen and largely involves the CDRs of the antibody.
- Antibody-combining sites come in many shapes and sizes; anti-protein antibodies tend to have more extended recognition surfaces than antibodies to carbohydrates or peptides that are more likely to involve grooves or pockets.
- Both antibody and antigen can sometimes undergo local changes in conformation to permit interaction.

- Protein antigens are processed within cells to form small linear peptides that associate with the MHC molecules, binding to the central groove formed by the α -helices and the β -sheet floor.

Processing of antigen for presentation by class I MHC

- Endogenous cytosolic antigens such as viral proteins are cleaved by (*immuno*)**proteasomes** and the peptides so formed are **transported** to the ER by TAP1 and TAP2.
- The peptide then dissociates from the TAP molecules and forms a stable heterotrimer with newly synthesized class I MHC heavy chain and β_2 -microglobulin.
- This **peptide-MHC complex** is then transported to the cell surface for presentation to cytotoxic T-cells.

▲ A chapter summary which can be used for both study and revision purposes.

Cell guide

Throughout the illustrations, standard forms have been used for commonly occurring cells and pathways. A key to these is given in the figure below.

User guide		
 Small lymphocyte	 Macrophage (Mφ)	 Plasma cell
 Mast cell	 Polymorphonuclear leucocyte (polymorph)	
→	Gives rise to	→
- - -	Inhibit/kill	
		→ Stimulates
		Blocked pathway

We hope you enjoy using your new textbook. Good luck with your studies!

About the companion website

Don't forget to visit the companion website for this book:



www.roitt.com

The website includes

- Interactive MCQs and SBA questions for each chapter, with feedback on all answers selected
- Animations and videos showing key concepts
- Fully downloadable figures and illustrations, further reading, and glossary
- Extracts from the *Encyclopedia of Life Sciences*
- Podcasts to reinforce the key principles explained in the text: ideal for revision “on the go”

Scan this QR code to visit the companion website





Part 1 Fundamentals of immunology

CHAPTER 1

Innate immunity

Key topics

- Knowing when to make an immune response 4
- Pattern recognition receptors detect nonself 7
- Immune responses are tailored towards particular types of infection 8
- Innate versus adaptive immunity 10
- External barriers against infection 12
- Cells of the immune system 12
- The beginnings of an immune response 18
- There are several classes of pattern recognition receptors 22
- Phagocytic cells engulf and kill microorganisms 29
- Phagocytes employ an array of killing mechanisms 30
- Complement facilitates phagocytosis and bacterial lysis 34
- Humoral mechanisms provide an additional defensive strategy 38
- Natural killer cells kill virally infected cells 42
- Dealing with large parasites 45
- The innate immune system instigates adaptive immunity 45

Roitt's Essential Immunology, Thirteenth Edition. Peter J. Delves, Seamus J. Martin, Dennis R. Burton, and Ivan M. Roitt.
 © 2017 John Wiley & Sons, Ltd. Published 2017 by John Wiley & Sons, Ltd.
 Companion website: www.roitt.com

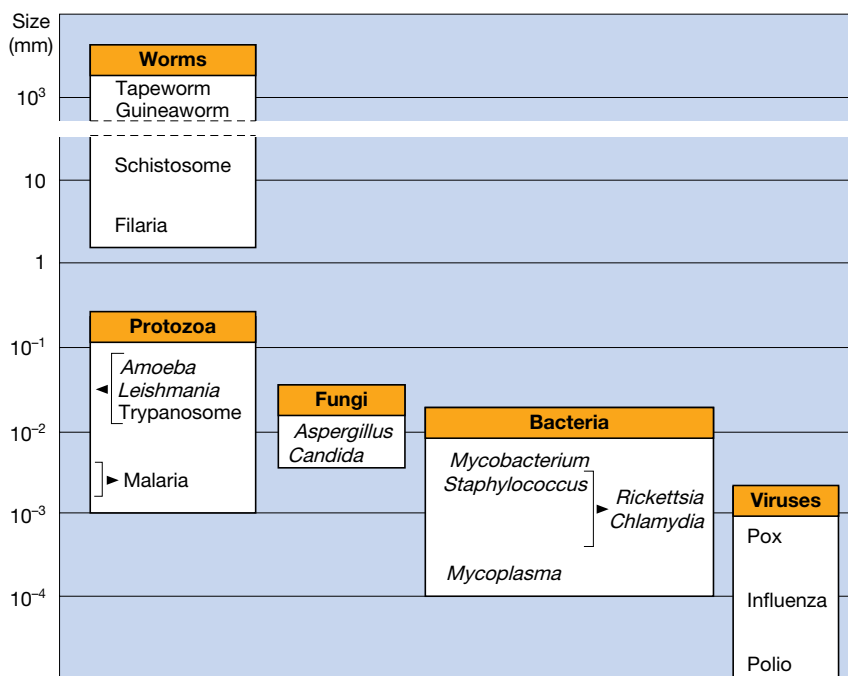


Figure 1.1 The formidable range of infectious agents that confront the immune system. Although not normally classified as such because of their lack of a cell wall, the mycoplasmas are included under bacteria for convenience. Fungi adopt many forms and approximate values for some of the smallest forms are given. Square brackets with right arrowheads indicate where a range of sizes is observed for the organism(s); square brackets with left arrowheads indicate list of organisms with a definite size.

Introduction

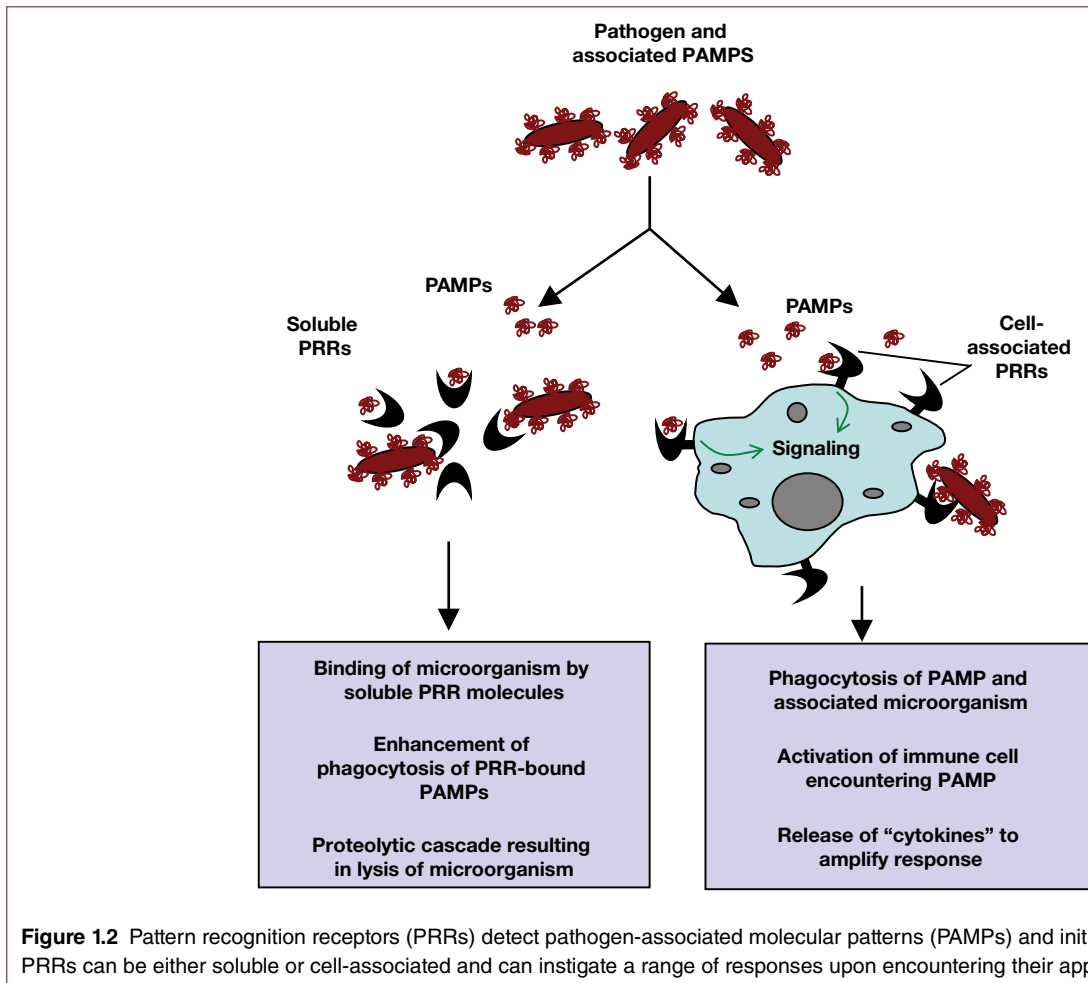
We live in a potentially hostile world filled with a bewildering array of infectious agents (Figure 1.1) of diverse shape, size, composition, and subversive character that would very happily use us as rich sanctuaries for propagating their “selfish genes” had we not also developed a series of defense mechanisms at least their equal in effectiveness and ingenuity (except in the case of many parasitic infections in which the situation is best described as an uneasy and often unsatisfactory truce). It is these defense mechanisms that can establish a state of immunity against infection (Latin *immunitas*, freedom from) and whose operation provides the basis for the delightful subject called “immunology.”

Aside from ill-understood constitutional factors that make one species innately susceptible and another resistant to certain infections, a number of relatively nonspecific but nonetheless highly effective antimicrobial systems (e.g., phagocytosis, production of antimicrobial peptides and reactive oxygen species) have been recognized that are *innate* in the sense that they are not affected by prior contact with the infectious agent and take immediate effect upon encounter with anything that our immune systems deem to be an unwelcome guest. We shall discuss these systems and examine how, in the state of *adaptive immunity*, their effectiveness can be greatly increased through custom tailoring of the response towards microbial intruders.

Knowing when to make an immune response

The ability to recognize and respond to foreign entities is central to the operation of the immune system

The vertebrate immune system is a conglomeration of cells and molecules that cooperate to protect us from infectious agents and also provides us with a surveillance system to monitor the integrity of host tissues. Although the immune system is quite elaborate, as we shall see, its function can be boiled down to two basic roles: **recognition** of foreign substances and organisms that have penetrated our outer defences (i.e., the skin epithelium and the mucosal surfaces of the gut and reproductive and respiratory tracts) and **elimination** of such agents by a diverse repertoire of cells and molecules that act in concert to neutralize the potential threat. Thus, a critical role of the immune system is to determine what is foreign (what immunologists often call “nonself”) from what is normally present in the body (i.e., self). As a consequence, the cells and molecules that comprise the innate immune system are preoccupied with detecting the presence of particular **molecular patterns** that are typically associated with infectious agents (Figure 1.2). Charlie Janeway dubbed such molecules **pathogen-associated molecular patterns (PAMPs)** and it is these structures that trigger activation of the innate immune system.



In addition to the fundamental roles of recognition and elimination of infectious agents, it is also very useful to be able to learn from encounters with pathogens and to maintain a reserve of cells that are able to respond swiftly to a new infection with a previously encountered microbe. Forewarned is forearmed, and in this situation it may be possible to deliver a decisive blow that ends a nascent infection before it has begun. Fortunately, our immune systems have also acquired this ability, which is what our *adaptive immune system* excels in, and this property is termed *immunological memory*.

Immune responses need to be proportional to the infectious threat

Having established that recognition, elimination and memory of infectious agents are fundamental to the operation of an effective immune system, there is another important factor, *proportionality*, which is key to ensuring that everything runs smoothly and that our immune systems do not lose sight of their purpose. This is because, as we shall see, the immune system can deploy a variety of weapons, each with their own risk of collateral damage, which can sometimes cause as much

trouble as the infection itself. In extreme cases, the immune response can be much more destructive than the agent that triggered it (which is what underpins allergy) and in some situations this can lead to a sustained state of *chronic immune activation* where the immune system becomes confused between what is self and nonself and mounts sustained responses against its own tissues (called autoimmunity). Thus, there is a cost-benefit analysis that must be conducted during the initial stages of an infection to ascertain the nature of the infection, the level of infection, and whether the infectious agent is perturbing tissue function (by triggering cell death for example).

For these reasons, a number of *immune regulatory* mechanisms exist to ensure that immune responses are proportional to the level of threat that a particular infectious agent poses, as well as to ensure that immune responses are not directed against self and that responses directed against nonself are terminated when the infectious agent has been successfully eliminated from the body. Immune regulatory mechanisms (or *immune checkpoints*) set thresholds for the deployment of immune responses and are vital to the proper operation of the immune system. As we shall see in later chapters, many diseases are caused by the failure of immune

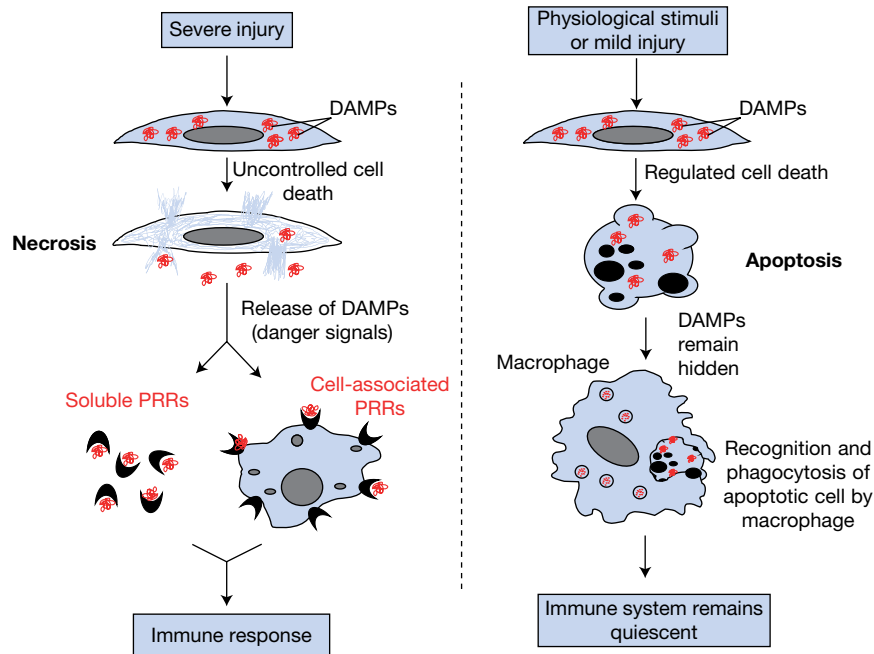


Figure 1.3 Necrotic cells release danger-associated molecular patterns (DAMPs), whereas apoptotic cells typically do not. Stimuli that induce necrosis frequently cause severe cellular damage, which leads to rapid cell rupture with consequent release of intracellular DAMPs. DAMPs can then engage cells of the immune system and can promote inflammation. On the other hand, because stimuli that initiate apoptosis are typically physiological and relatively mild, apoptotic cells do not rupture and their removal is coordinated by macrophages and other cells of the innate immune system, before release of DAMPs can occur. For this reason, apoptosis is not typically associated with activation of the immune system.

checkpoints, leading to conditions such as rheumatoid arthritis, Crohn's disease, and even cancer.

Tissue damage can also instigate an immune response

Aside from infection, there is a growing recognition that tissue damage, leading to nonphysiological cell death, can also provoke activation of the immune system (Figure 1.3). In this situation, the molecules that activate the immune system are derived from self but are not normally present within the extracellular space, or in a particular cellular compartment (for example when mitochondrial DNA is released into the cytoplasm). Such molecules, for which Polly Matzinger coined the term *danger signals*, are normally safely sequestered within healthy cells and organelles and only escape when a cell dies via an uncontrolled mode of cell death, called *necrosis* (see Videoclip 1). Necrosis is typically caused by tissue trauma, burns, certain toxins, as well as other nonphysiological stimuli, and is characterized by rapid swelling and rupture of the plasma membranes of damaged cells. This permits the release of multiple cellular constituents that do not normally escape from healthy cells or organelles.

The precise identity of the molecules that act as danger signals – now more commonly called *danger-associated molecular patterns (DAMPs)* or alarmins – is an area of active

investigation at present, but molecules such as HMGB1, a chromatin-binding protein, as well as the immunological messenger proteins interleukin-1 α (IL-1 α) and IL-33, represent good candidates. It might seem surprising that the immune system can also be activated by self-derived molecules, however, this makes good sense when one considers that events leading to necrotic cell death are often rapidly followed or accompanied by infection. Furthermore, if a pathogen manages to evade direct detection by the immune system, its presence will be betrayed if it provokes necrosis within the tissue it has invaded.

Before moving on, we should also note that there is another mode of cell death that frequently occurs in the body that is both natural and highly controlled and is not associated with plasma membrane rupture and release of intracellular contents. This mode of cell death, called *apoptosis* (see Videoclip 2), is under complex molecular control and is used to eliminate cells that have reached the end of their natural lifespans. Apoptotic cells do not activate the immune system because cells dying in this manner display molecules on their plasma membranes (e.g., phosphatidylserine) that mark these cells out for removal through phagocytosis before they can rupture and release their intracellular contents. In this way, DAMPs remain hidden during apoptosis and such cells do not activate the immune system (Figure 1.3).

Pattern recognition receptors detect nonself

Pattern recognition receptors (PRRs) raise the alarm

To identify potentially dangerous microbial agents, our immune systems need to be able to discriminate between “non-infectious self and infectious nonself” as Janeway elegantly put it. Recognition of nonself entities is achieved by means of an array of **pattern recognition receptors and proteins** (collectively called pattern recognition molecules) that have evolved to detect conserved (i.e., not prone to mutation) components of microbes that are not normally present in the body (i.e., PAMPs).

In practice, PAMPs can be anything from carbohydrates that are not normally exposed in vertebrates, proteins only found in bacteria, such as flagellin (a component of the bacterial flagellum that is used for swimming), double-stranded RNA that is typical of RNA viruses, as well as many other molecules that betray the presence of microbial agents. The cardinal rule is that a **PAMP is not normally found in the body but is a common and invariant feature of many frequently encountered microbes**. Pattern recognition molecules also appear to be involved in the recognition of DAMPs released from necrotic cells.

Upon engagement of one or more of these pattern recognition molecules with an appropriate PAMP or DAMP, an immune response ensues (Figure 1.2). Fortunately, we have many ways in which an impending infection can be dealt with, and indeed it is a testament to the efficiency of our immune systems that the majority of us spend most of our lives relatively untroubled by infectious disease.

A variety of responses can occur downstream of pattern recognition

One way of dealing with unwelcome intruders involves the binding of soluble (humoral) pattern recognition molecules, such as **complement** (an enzyme cascade we will deal with later in this chapter), **mannose-binding lectin**, **C-reactive protein**, or **lysozyme**, to the infectious agent. The binding of soluble pattern recognition molecules to a pathogen has a number of outcomes (Figure 1.2).

First, this can lead directly to **killing of the pathogen** through destruction of microbial cell wall constituents and breaching of the plasma membrane because of the actions of such proteins. Second, humoral factors are also adept at coating microorganisms (a process called **opsonization**) and this greatly enhances their uptake through **phagocytosis** and subsequent destruction by phagocytic cells.

Other PRRs are cell associated and engagement of such receptors can also lead to **phagocytosis** of the microorganism followed by its destruction within phagocytic vesicles. Just as importantly, cellular PRR engagement also results in the activation of signal transduction pathways that greatly enhance the

effector functions of cells bearing these receptors (such as increasing their propensity for phagocytosis or the production of antimicrobial proteins) and also culminate in the release of soluble messenger proteins (**cytokines**, **chemokines**, and other molecules) that mobilize other components of the immune system. PRR engagement on effector cells can also result in **differentiation** of such cells to a more mature state that endows specialized functions on such cells. Later we will deal with a very important example of this when we discuss the issue of dendritic cell maturation, which is initiated as a consequence of engagement of PRR receptors on these cells by microbial PAMPs. Therefore, pattern recognition of a pathogen by soluble or cell-associated PRRs can lead to:

- direct lysis of the pathogen
- opsonization followed by phagocytosis
- direct phagocytosis via a cell-associated PRR
- enhancement of phagocytic cell functions
- production of antimicrobial proteins
- production of cytokines and chemokines
- differentiation of effector cells to a more active state.

There are several classes of pattern recognition receptor

As we shall see later in this chapter, there are a number of different classes of cell-associated PRRs (Toll-like receptors [TLRs], C-type lectin receptors [CTLRs], NOD-like receptors [NLRs], RIG-I-like receptors [RLRs], among others) and it is the engagement of one or more of these different categories of receptors that not only enables the **detection of infection**, but also conveys information concerning the **type** of infection (whether yeast, bacterial, or viral in origin) and its **location** (whether extracellular, endosomal, or cytoplasmic). In practise, most pathogens are likely to engage several of these receptors simultaneously, which adds another level of complexity to the signaling outputs that can be generated through engagement of these receptors. This, in turn, enables the **tailoring of the subsequent immune response** towards the particular vulnerabilities of the pathogen that raised the alarm.

Cells of the immune system release messenger proteins that shape and amplify immune responses

An important feature of the immune system is the ability of its constituent cells to communicate with each other upon encountering a pathogen to initiate the most appropriate response. As we shall see shortly, there are quite a number of different “ranks” among our immune forces, each with their own particular arsenal of weapons, and it is critical that a measured and appropriate response is deployed in response to a specific threat. This is because, as we have already alluded to, many of the weapons that are brought into play during an immune response are destructive and have the potential to cause collateral damage. Furthermore, initiation and escalation of an immune response carries a significant metabolic cost to

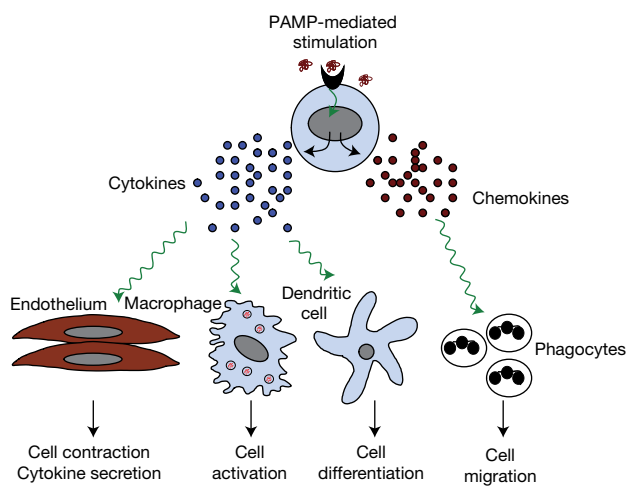


Figure 1.4 Cytokines and chemokines can have pleiotropic effects. Stimulation of cells of the innate immune system frequently leads to the production of inflammatory cytokines and chemokines that trigger responses from other cell types, as depicted. Note that the effects of chemokines and cytokines shown are not exhaustive.

the organism (due to the necessity to make numerous new proteins and cells). Thus, communication among the different immune battalions is essential for the initiation of the correct and proportional response to the particular agent that triggered it. Although cells of the immune system are capable of releasing numerous biologically active molecules with diverse functions, two major categories of proteins – **cytokines** and **chemokines** – have particularly important roles in shaping and escalating immune responses.

Cytokines are a diverse group of proteins that have **pleiotropic effects**, including the ability to activate other cells, **induce differentiation** to particular effector cell subsets and enhance microbicidal activity (Figure 1.4). Cytokines are commonly released by cells of the immune system in response to PAMPs and DAMPs, and this has the effect of altering the **activation state** and **behavior** of other cells to galvanize them into joining the fight. Chemokines are also released upon encountering PAMPs/DAMPs and typically serve as **chemotactic factors**, helping to lay a trail that guides other cells of the immune system to the site of infection or tissue damage. Both types of messenger proteins act by diffusing away from the cells secreting them and binding to cells equipped with the appropriate plasma membrane receptors to receive such signals.

The interleukins are an important class of cytokines

A particularly important group of cytokines in the context of immune signaling is the interleukin (IL) family, which has over 40 members at present, numbered in the order of their discovery. Thus, we have IL-1, IL-2, IL-3, IL-4, etc. Interleukins, by definition, are cytokines that signal between members of the

leukocyte (i.e., white blood cell) family. However, these molecules often have effects on other tissues that the immune system needs to engage in the course of initiating immune responses. So, although **interleukins are heavily involved in communication between immune cells**, these cytokines also have profound effects on endothelial cells lining blood capillaries, hepatocytes in the liver, epithelial cells, bone marrow stem cells, fibroblasts, and even neurons within the central nervous system. It is also important to note that **the same interleukin can trigger different functional outcomes** depending on the cell type that it makes contact with; these are simply “switch” molecules that can turn different functions on or off in the cells they encounter. The function that is switched on, or off, will depend on the target cell and the other cytokine signals that this cell is receiving in tandem. Thus, just as we integrate lots of different sources of information (e.g., from colleagues, friends, family, newspapers, TV, radio, books, websites, social media, etc.) in our daily lives that can all influence the decisions we make, **cells also integrate multiple sources of cytokine information to make decisions** on whether to divide, initiate phagocytosis, express new gene products, differentiate, migrate, and even die. We will discuss cytokines, chemokines, and their respective receptors at length in Chapter 8.

Immune responses are tailored towards particular types of infection

Not all pathogens are equal

We will shortly get into the specifics of the immune system, but before doing so it is useful to consider the diversity of infectious agents that our immune systems may encounter (Figure 1.1), and to contemplate whether a “one size fits all” immune response is likely to suffice in all of these situations. One of the frustrations expressed by many students of immunology is that the immune system appears to be almost byzantine in its complexity. Although this is indeed partly true, the reasons for this are two-fold. First, because there are different types of infection, **immune responses need to be tailored towards the particular class of infection** (whether viral, extracellular bacterial, intracellular bacterial, worm, fungal, etc.) in order to mount the most effective immune response towards a particular infectious agent. Second, although there is indeed complexity in the immune system, there is also a great deal of order and repeated use of the same basic approach when recognizing pathogens and initiating an immune response. Therefore, although many of molecules used in the pursuit of pathogen recognition belong to different classes, many of these plug into the same effector mechanisms as soon as the pathogen is successfully identified. So, dear reader, please bear with us while we try to make sense of the apparent chaos. But meanwhile, let us get back to pathogens to consider why our immune systems need to be fairly elaborate and multi-layered.

Infectious agents are a broad church and have evolved different strategies to invade and colonize our bodies, as well as to evade immune detection. Some, such as yeasts and extracellular

bacteria, are happy to live in the extracellular space, stealing nutrients that would otherwise nourish our own tissues. Others, such as intracellular bacteria and viruses, invade the cytoplasm and even our genomes and may lurk for months or years within our bodies. Then there are the large worms (helminths) and unicellular eukaryotic protozoa that live parasitic lifestyles with their own particular adaptations.

Because of the diversity of infectious agents, all of which have their own strategies to evade and neutralize the best efforts of our immune systems, we have responded by evolving multiple ways of dealing with intruders, depending on the nature of the infectious agent and how this type of infection is best dealt with. Indeed, it is the constant threat of infection (rather than environmental change) that is the major driver of natural selection over the short term, as viruses and bacteria can mutate with frightening speed to acquire adaptations that can leave their hosts highly vulnerable to infection. For this reason, genes that are involved in the functioning and regulation of the immune system are among the most diverse among human and animal populations (i.e., undergoing the fastest rates of mutation) and are frequently duplicated into large gene families (which are typically variations on a very useful theme) that permits us to hedge our bets and stay ahead in the ongoing battle against those organisms that would have us for lunch.

Because of the diverse nature of the infectious agents that we are confronted with, **immune responses come in a number of different flavors** and are **tailored towards the nature of the pathogen that provoked the response** in the first place. As the book progresses, we will elaborate on this concept in much more detail, but do keep this in mind when trying to understand the underlying simplicity among the apparent complexity of the immune responses that we will encounter.

There are different types of immune response

So, what do we mean by different types of immune response? We are not going to be exhaustive at this stage, but let us consider the difference between how our immune system might deal with a virus versus an extracellular bacterium. For both pathogen classes, a system that enables us to recognize these agents and to remove them, either by destroying them (through membrane lysis) or by eating them up (through phagocytosis) followed by degradation within endosomes, would likely be very effective. And indeed, our immune systems have evolved a number of ways of doing both of these things; as we have mentioned earlier, there are multiple classes of proteins that **recognize and lyse bacteria and viruses** in the extracellular space (complement, acute phase proteins, antimicrobial peptides) and the same proteins are frequently involved in **decorating infectious agents for recognition and phagocytosis** by phagocytic cells (e.g., macrophages and neutrophils) that are specialized in doing just that. Molecules that are involved in the decoration of infectious agents to prepare them for removal are called **opsonins** (from the Greek, to prepare for eating) in immunological parlance. So far, so good.

However, once the virus enters a cell, the proteins and phagocytic cells mentioned above will no longer be of any use in dealing with this type of infection as proteins cannot freely diffuse across the plasma membrane to either lyse or tag the infectious agent for phagocytosis. So, it is here that the immune response to an extracellular bacterial infection versus an intracellular viral infection must diverge, as now we need a way of looking inside cells to see whether they are infected or not. Consequently, we have evolved a number of **intracellular PRRs that can detect pathogens that have entered cells**, and this results in the production of signals (e.g., cytokines and chemokines) that alert the immune system to the presence of an infectious agent. Just as importantly, we have also evolved a fiendishly clever way of displaying the breakdown products of pathogens to cells of the adaptive immune system (**major histocompatibility complex** [MHC] molecules are centrally involved in this process) irrespective of whether the infectious agent lives inside or outside the cell. We will deal with MHC molecules extensively in Chapters 4 and 5. The latter process enables a cell that has been infected by a virus to display fragments of viral proteins on its plasma membrane, within grooves present in MHC molecules that have evolved for this purpose, thereby alerting cells of the immune system to the nature of its predicament. Ingenious!

So, how does our immune system deal with a virus or other pathogen that has invaded a host cell? Although some specialized phagocytic cells (i.e., macrophages) can kill intracellular bacteria that have invaded them, most cells cannot do this very effectively and so another solution is required. For most other cell types, this is achieved through **killing the infected cell** (typically by apoptosis) and removing it through **phagocytosis**, which is easy to write, but involves a series of steps that permit the recognition of infected host cells, the delivery of the “kiss of death” and the engulfment of the infected corpse in a manner that minimizes the escape of the pathogen lurking within. Our immune systems have solved the intracellular infection problem by evolving cells (called **cytotoxic T-cells** and **natural killer cells**) that have the ability to detect infected cells and to kill them; we will deal with natural killer (NK) cells in detail later in this chapter.

Obviously, such powers of life or death carry with them the heavy responsibility of ensuring that uninfected cells are not accidentally killed, as it is a basic tenet of multicellularity that one does not go around randomly killing good cellular citizens. Thus, a number of checks and balances have been incorporated into this killing system to ensure that only errant cells are dispatched in this way. We will deal with the detailed mechanisms of cytotoxic T-cell-mediated killing in Chapter 8.

However, some pathogens require a different approach, which involves sending in large numbers of highly phagocytic cells (such as neutrophils) into a tissue that can also deploy destructive proteases, carbohydrases (such as lysozyme), and other nasty molecules into the extracellular space in order to quickly overwhelm and destroy a rapidly dividing pathogen, or a worm parasite. This type of response comes with a certain

degree of collateral damage (due to the use of enzymes that do not discriminate between friend and foe) and is typically only mounted when this is warranted.

From the preceding discussion, we hope that it will be evident that *different types and severities of immune responses are necessary to fight different types of infection* and it is for this reason that the immune system has a variety of cells and weapons at its disposal. Thus, there are different types of immune response, broadly dictated by whether a pathogen lives *intracellularly or extracellularly*.

The PRRs of the innate immune system generate a molecular fingerprint of pathogens

As we have already alluded to, the PRRs not only help to identify the *presence* of infectious agents through detection of their associated PAMPs, but they also convey information as to the *nature* of the infectious agent (whether of fungal, bacterial or viral origin) and the *location* of the infectious agent (whether extracellular, intracellular, endosomal, cytoplasmic, or nuclear). This is because, as we shall see later, the various classes of PRRs (e.g., Toll-like receptors, C-type lectin receptors, NOD-like receptors, cytoplasmic DNA sensors) are specific for different types of pathogen components (i.e., PAMPs), and reside in different cellular compartments. Thus, we have an ingenious system where the combination of PRRs that is engaged by an infectious agent conveys important information about the precise nature and location of infection and generates a *molecular fingerprint of the pathogen*. In turn, *this information is then used to shape the most effective immune response* towards the particular pathogen class that provoked it.

Cytokines help to shape the type of immune response that is mounted in response to a particular pathogen

We have already mentioned that cytokines are involved in communication between cells of the immune system and help to alert the correct cell types that are appropriate for dealing with different classes (i.e., whether viral, bacterial, yeast, etc.) of infectious agents. Cytokines are also capable of triggering the *maturation and differentiation* of immune cell subsets into more specialized *effector cell* classes that possess unique capabilities to enable them to fight particular types of infection. In this way, detection of an infection (i.e., PAMPs) by a particular class of PRR is translated into the most appropriate immune response *through the production of particular patterns of cytokines and chemokines*. These cytokine patterns then call into play the correct cell types and trigger maturation of these cells into even more specific effector cell subtypes. Later, in Chapter 8, we will see how this process is used to produce specialized subsets of T-cells that are central to the process of adaptive immunity. Let us now look at how the different layers of our immune defenses are organized.

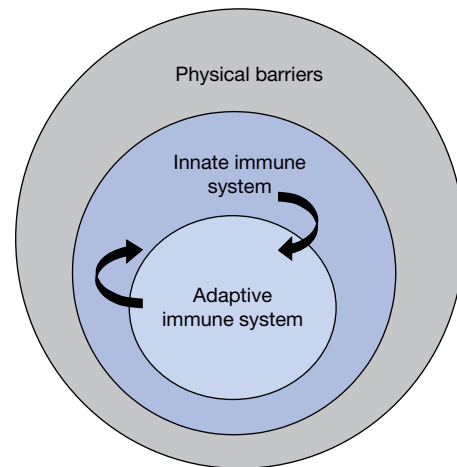


Figure 1.5 The vertebrate immune system comprises three levels of defense. The physical barriers of the skin and mucosal surfaces comprise the first level of defense. Infectious agents that successfully penetrate the physical barriers are then engaged by the cells and soluble factors of the innate immune system. The innate immune system is also responsible for triggering activation of the adaptive immune system, as we will discuss later in this chapter. The cells and products of the adaptive immune system reinforce the defense mounted by the innate immune system.

Innate versus adaptive immunity

Three levels of immune defense

Before we get into the details, we will first summarize how the immune system works in broad brushstrokes. The vertebrate immune system comprises three levels of defense (Figure 1.5). First, there is a *physical barrier* to infection that is provided by the skin on the outer surfaces of the body, along with the mucous secretions covering the epidermal layers of the inner surfaces of the respiratory, digestive, and reproductive tracts. Any infectious agent attempting to gain entry to the body must first breach these surfaces that are largely impermeable to microorganisms; this is why cuts and scrapes that breach these physical barriers are often followed by infection. The second level of defense is provided by the *innate immune system*, a relatively broad-acting but highly effective defense layer that is largely preoccupied with trying to kill infectious agents from the moment they enter the body. The actions of the innate immune system are also responsible for alerting the cells that operate the third level of defense, the *adaptive (or acquired) immune system*. The latter cells represent the elite troops of the immune system and can launch an attack that has been specifically adapted to the nature of the infectious agent using sophisticated weapons such as antibodies. As we shall see, the innate and adaptive immune systems each have their own particular advantages and disadvantages and therefore act cooperatively to achieve much more effective immune protection than either could achieve in isolation.

Innate immune responses are immediate and relatively broad acting

Upon entry of a foreign entity into the body, the innate immune response occurs almost immediately. Innate immune responses do not improve (at least to a dramatic degree) upon frequent encounter with the same infectious agent. The innate immune system recognizes broadly conserved components of infectious agents, the aforementioned PAMPs, which are not normally present in the body. The molecules and receptors (i.e., PRRs) used by the innate immune system to detect PAMPs are hard-wired (i.e., germline encoded, which means that such genes are passed in essentially identical form from parent to offspring) and respond to **broad categories** of foreign molecules that are commonly expressed on microorganisms. The relatively invariant nature of PRRs is a strength, as well as a weakness, of the innate immune system. It is a strength in terms of discriminating self from nonself very reliably (as PRRs have evolved over millions of years to be able to detect nonself, while ignoring self), but is a weakness in that the **specificity of a given PRR towards an individual pathogen is poor** as these receptors do not mutate at any appreciable rate. Thus, innate immune responses cannot be uniquely tailored towards a specific pathogen, at least beyond the number of individual PRRs that our innate immune systems possess.

Because the receptors of the innate immune system are encoded by the germline, innate immune responses are therefore quite similar between individuals of the same species. Upon detecting a PAMP, the innate immune system mounts an immediate attack on anything displaying such molecules by either engulfing such entities or through attacking them with destructive enzymes, such as proteases or membrane-attacking proteins (Figure 1.2). The clear intent is to bludgeon the unwanted intruder into submission as quickly as possible. This makes sense when one considers the prodigious rates of proliferation that bacteria can achieve (many bacterial species are capable of dividing every 20 minutes or so), particularly in the nutrient-rich environment our bodies provide. Key players in the innate immune response include **macrophages**, **neutrophils**, and soluble bactericidal (i.e., bacteria killing) proteins such as **complement** and **lysozyme**. Although highly effective, innate immune responses are not always sufficient to completely deal with the threat, particularly if the infectious agent is well adapted to avoid the initial attack. In this situation, a more specific immune response is required, tailored towards particular determinants that are present on individual pathogens. This is where the adaptive immune response comes into play.

Adaptive immune responses are delayed but highly specific

Because of the way in which adaptive immune responses are initiated, such responses take longer to achieve functional significance, typically 4–5 days after the innate immune response, but are **exquisitely tailored** to the nature of the infectious

agent. How the pathogen-detecting receptors of the adaptive immune system (such as antibody) achieve their high specificity will be discussed at length in later chapters, but in brief this involves the shuffling of a relatively small number of receptor precursors that, through the power of random genetic recombination, can produce a truly spectacular number of specific antigen receptors (numbering in the tens of millions). The major downside to this genetic recombination process is that it is **prone to producing receptors that recognize self**. However, the adaptive immune system has evolved ways of dealing with this problem, as will be discussed in Chapter 10.

Importantly, because the antigen receptors of the adaptive immune system are custom-built to recognize specific pathogens, such responses improve upon each encounter with a particular infectious agent, a feature called **immunological memory**, which underpins the concept of vaccination. The adaptive immune response is mediated primarily by **T- and B-lymphocytes** and these cells display specific receptors on their plasma membranes that can be tailored to recognize an almost limitless range of structures. By definition, molecules that are recognized by T- and B-lymphocytes are called **antigens**. Recognition of antigen by a lymphocyte triggers proliferation and differentiation of such cells and this has the effect of greatly increasing the numbers of lymphocytes capable of recognizing the particular antigen that triggered the response in the first place. This rapidly swells the ranks of lymphocytes (through a process called **clonal expansion**, which enables the rapid division of cells carrying a particular antigen receptor) capable of dealing with the infectious agent bearing the specific antigen and results in a **memory response** if the same antigen is encountered at some time in the future. We will look in detail at the receptors used by T- and B-cells to see antigen in Chapter 4.

Innate and adaptive immune responses are interdependent

The innate and adaptive immune systems work in tandem to identify and kill infectious agents (Figure 1.5). As we shall see in later chapters, while the innate and adaptive immune systems have their own individual strengths, there are multiple points at which the innate immune system feeds into the adaptive immune system and visa versa. In this way, both systems synergize to deal with infectious agents. Thus, when an infection occurs, **the innate immune system serves as a rapid reaction force** that deploys a range of relatively nonspecific (but nonetheless highly effective) weapons to eradicate the infectious agent, or at the very least to keep the infection contained. This gives time for the initially sluggish adaptive immune system to select and clonally expand cells with receptors that are capable of making a much more specific response that is uniquely tailored to the infectious agent. **The adaptive immune response to an infectious agent reinforces and adds new weapons to the attack** mounted by the innate immune system.

Although it was once fashionable to view the innate immune system as somewhat crude and clumsy when compared

to the relative sophistication of the adaptive immune system, an explosion of new discoveries over the past 10–15 years has revealed that the innate immune system is just as highly adapted and sophisticated as the adaptive immune system. Moreover, it has also become abundantly clear that ***the adaptive immune system is highly dependent on cells of the innate immune system for the purposes of knowing when to respond, how to respond, and for how long.***

The main reason for this, as we discussed earlier, is that the innate immune system uses hard-wired receptors (PRRs) that are highly reliable in terms of discriminating self from nonself. In contrast, because the adaptive immune system uses receptors that are ***generated de novo through random genetic recombination in response to each infectious agent that is encountered, these receptors can easily end up recognizing self, a situation that is highly undesirable.*** Therefore, ***cells of the adaptive immune system require instruction (or permission) by cells of the innate system*** as to whether an immune response should be mounted towards a particular antigen. Furthermore, the precise nature of the PRRs that are engaged on cells of the innate immune system in the initial stages of an infection dictate the type of adaptive immune response that is required (through the production of specific cytokines and chemokines). We will return to these important issues later in this chapter, but for now let us consider the external barriers to infection in a little more detail.

External barriers against infection

As mentioned above, the simplest way to avoid infection is to prevent the microorganisms from gaining access to the body (Figure 1.6). When intact, the skin is impermeable to most infectious agents; when there is skin loss, as for example in burns, infection becomes a major problem. Additionally, most bacteria fail to survive for long on the skin because of the direct inhibitory effects of lactic acid and fatty acids in sweat and sebaceous secretions and the low pH that they generate. An exception is *Staphylococcus aureus*, which often infects the relatively vulnerable hair follicles and glands.

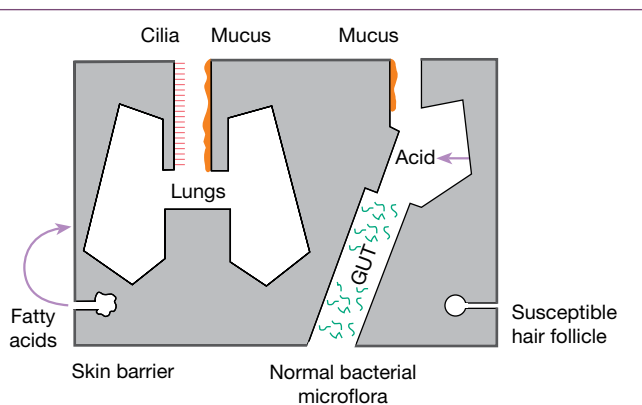


Figure 1.6 The first lines of defense against infection: protection at the external body surfaces.

Mucus, secreted by the membranes lining the inner surfaces of the body, acts as a protective barrier to block the adherence of bacteria to epithelial cells. Microbial and other foreign particles trapped within the adhesive mucus are removed by mechanical stratagems such as ciliary movement, coughing, and sneezing. Among other mechanical factors that help protect the epithelial surfaces, one should also include the washing action of tears, saliva, and urine. Many of the secreted body fluids contain bactericidal components, such as acid in gastric juice, spermine and zinc in semen, lactoperoxidase in milk, and lysozyme in tears, nasal secretions, and saliva.

A totally different mechanism is that of ***microbial antagonism*** associated with the normal bacterial flora of the body (i.e., commensal bacteria). This suppresses the growth of many potentially pathogenic bacteria and fungi at superficial sites by competition for essential nutrients or by production of inhibitory substances. To give one example, pathogen invasion is limited by lactic acid produced by particular species of commensal bacteria that metabolize glycogen secreted by the vaginal epithelium. When protective commensals are disturbed by antibiotics, susceptibility to opportunistic infections by *Candida* and *Clostridium difficile* is increased. Gut commensals may also produce colicins, a class of bactericidins that bind to the negatively charged surface of susceptible bacteria and insert a hydrophobic helical hairpin into the membrane; the molecule then undergoes a “Jekyll and Hyde” transformation to become completely hydrophobic and forms a voltage-dependent channel in the membrane that kills by destroying the cell’s energy potential. Even at this level, survival is a tough game.

If microorganisms do penetrate the body, the innate immune system comes into play. Innate immunity involves two main defensive strategies to deal with a nascent infection: the ***destructive effect of soluble factors such as bactericidal enzymes*** and the mechanism of ***phagocytosis*** – literally “eating” by the cell (see Milestone 1.1). Before we discuss these strategies in more detail, let us first consider the major cellular players in the immune system.

Cells of the immune system

The cells of the immune system can be divided broadly into two main classes – myeloid and lymphoid cells

Immune cells, which are collectively called leukocytes (white blood cells), can be divided broadly into myeloid and lymphoid subsets (Figure 1.7).

Myeloid cells, which comprise the majority of the cells of the innate immune system, include ***macrophages*** (and their ***monocyte*** precursors), ***mast cells***, ***dendritic cells***, ***neutrophils***, ***basophils***, and ***eosinophils***. All myeloid cells have some degree of phagocytic capacity (although basophils are very poorly phagocytic compared to other myeloid cell types) and specialize in the detection of pathogens via membrane or endosomal PRRs, followed by engulfment and killing of infectious agents

by means of a battery of destructive enzymes contained within their intracellular granules.

Neutrophils are by far the most abundant leukocyte circulating in the bloodstream, comprising well over 50% of leukocytes, and these cells are **particularly adept at phagocytosing and killing microbes**. However, because of their destructive potential, neutrophils are not permitted to exit the blood and enter tissues until the necessity of their presence has been confirmed through the actions of other cells of the innate immune system (especially macrophages and mast cells), as well as soluble PRRs such as complement. As we shall see, certain myeloid cells, such as macrophages and dendritic cells, have particularly important roles in **detecting and instigating immune responses**, as well as presenting the components of phagocytosed microbes to cells of the lymphoid system. Broadly speaking, activated myeloid cells also have an important function in **escalating immune responses** through the secretion of multiple cytokines and chemokines as well as additional factors that have powerful effects on local blood vessels.

The other major class of immune cells, the **lymphoid cells**, comprise three main cell types, **T-lymphocytes**, **B-lymphocytes**, and **natural killer (NK) cells**. T- and B-lymphocytes are the central players in the adaptive immune system and have the ability to generate **highly specific cell surface receptors** (T- and B-cell receptors), through genetic recombination of a relatively limited number of precursors for these receptors (discussed in detail in Chapters 4 and 5). T-cell receptors (TCRs) and B-cell receptors (also called antibodies) can be generated that are exquisitely specific for particular molecular structures, called antigens, and can fail to recognize related antigens that differ by only a single amino acid. NK cells, although lymphocytes, play a major role within the innate immune system, but these cells also police the presence of special antigen-presenting molecules (the aforementioned MHC molecules) that are expressed on virtually all cells in the body and play a key role in the operation of the adaptive immune system. NK cells use germline-encoded receptors (called NK receptors) that are distinct from the receptors of T- and B-cells and are endowed with the ability to kill cells that express abnormal MHC receptor profiles, as well as other signs of infection.



Milestone 1.1 Phagocytosis

The perceptive Russian zoologist, Elie Metchnikoff (1845–1916; Figure M1.1.1), recognized that certain specialized cells mediate defense against microbial infections (Figure M1.1.2), so fathering the whole concept of cellular immunity. He was intrigued by the motile cells of transparent starfish larvae and made the critical observation that, a few hours after the introduction of a rose thorn into these larvae, they became surrounded by these motile cells. A year later, in 1883, he observed that fungal spores can be attacked by the blood cells of *Daphnia*, a tiny metazoan that, also being transparent, can be studied directly under the microscope. He went on to extend his investigations to mammalian leukocytes, showing their ability to engulf microorganisms, a process that he termed **phagocytosis**.

Because he found this process to be even more effective in animals recovering from infection, he came to a somewhat polarized view that phagocytosis provided the main, if not the only, defense against infection. He went on to define the existence of two types of circulating phagocytes: the polymorphonuclear leukocyte, which he termed a “microphage,” and the larger “macrophage.”

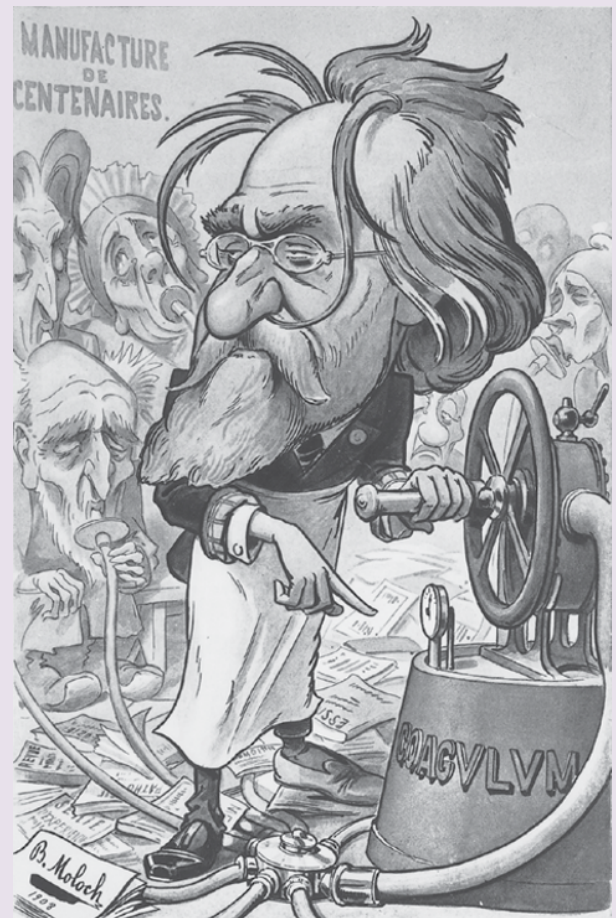


Figure M1.1.1 Caricature of Professor Metchnikoff. (Source: From *Chanteclair*, 1908, No. 4, p. 7. Reproduced with permission of The Wellcome Institute Library, London, UK.)

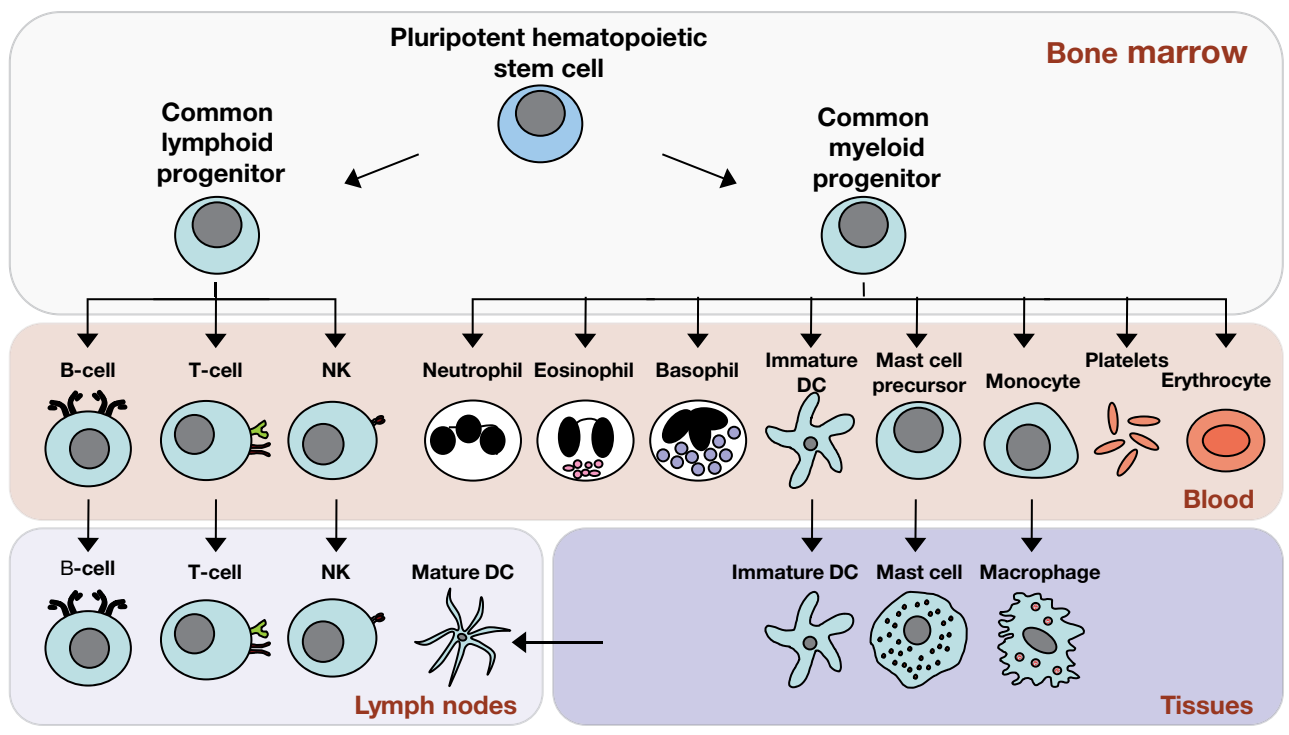
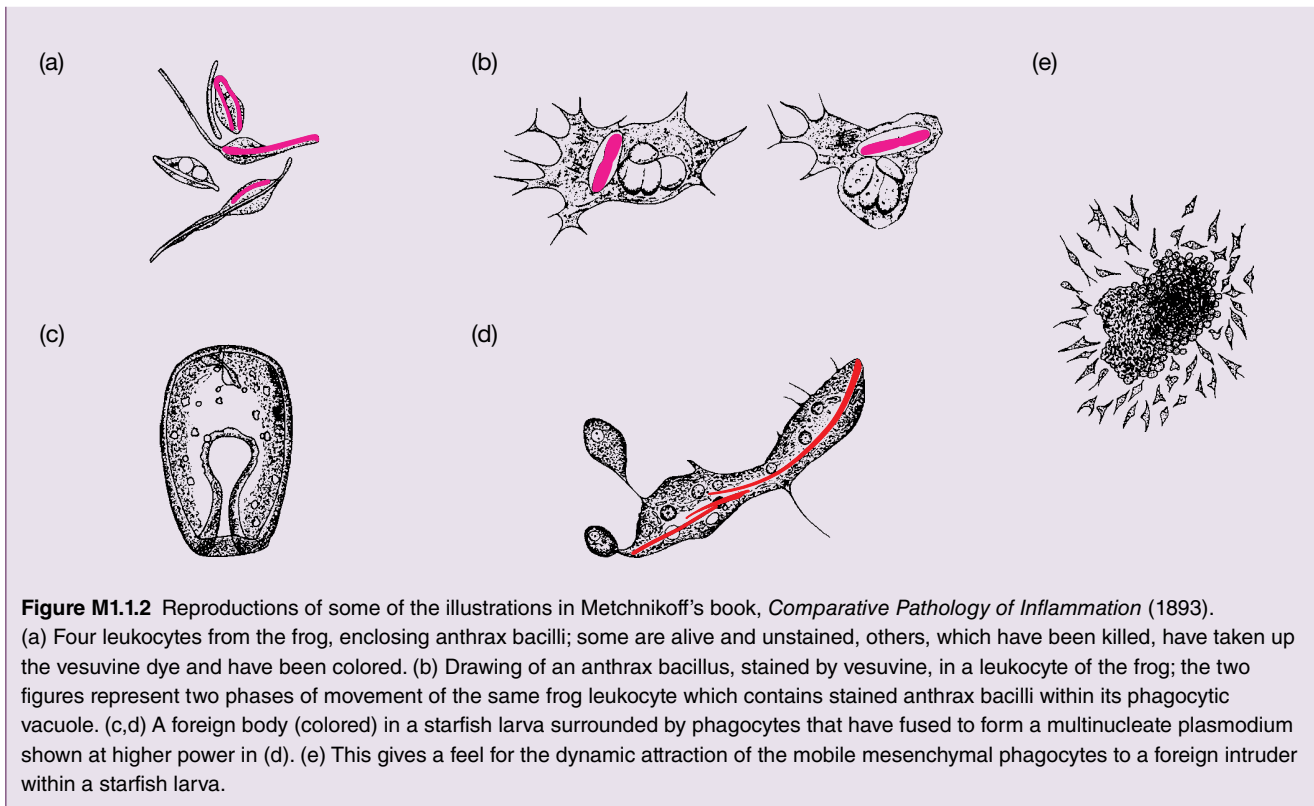


Figure 1.7 The cells of the immune system originate in the bone marrow from pluripotent hematopoietic stem cells. Pluripotent hematopoietic stem cells give rise to a common lymphoid progenitor, which gives rise to all of the major lymphoid cell types (T-cells, B-cells, and NK cells) or a common myeloid progenitor, which gives rise to all of the major myeloid cell types (neutrophils, eosinophils, basophils, dendritic cells [DCs], mast cells, and monocytes/macrophages) as well as the erythrocytes and megakaryocytes (which generate platelets). See further details of individual cell types in Figure 1.8, Figure 1.9, and Figure 1.11.

Cells of the immune system originate in the bone marrow

All cells of the lymphoid and myeloid lineages are derived from a **common hematopoietic stem cell progenitor** in the bone marrow (Figure 1.7). These stem cells, which are self-renewing, give rise to a **common lymphoid progenitor** as well as a **common myeloid progenitor**, from which the various types of lymphoid and myeloid cells differentiate (Figure 1.7). This process, called **hematopoiesis**, is complex and takes place under the guidance of multiple factors within the bone marrow, including stromal cells, the factors they produce and the influence of the extracellular matrix. Indeed, the study of this process is a whole research discipline in itself (hematology) and it has taken many years to unravel the multiplicity of cues that dictate the production of the formed elements of the blood. However, the basic scheme is that the various soluble and membrane-bound hematopoietic factors influence the differentiation of the various myeloid and lymphoid cell types in a stepwise series of events that involve the switching on of different **transcriptional programs** at each stage of the hierarchy, such that immature precursor cells are guided towards a variety of specific terminally differentiated cellular phenotypes (monocytes, neutrophils, mast cells, etc.). This process can also be influenced by factors external to the bone marrow (such as cytokines that are produced in the context of immune responses), to ramp up the production of specific cell types according to demand. Make no mistake, this is a large-scale operation with the average human requiring the production of almost 4×10^{11} leukocytes (400 billion) per day. One of the reasons for this prodigious rate of cell production is that many of the cells of the immune system, particularly the granulocytes (neutrophils, basophils, and eosinophils), have half-lives of only a day or so. Thus, these cells require practically continuous replacement.

Upon differentiation to specific mature lymphoid and myeloid cell types, the various leukocytes exit the bone marrow and either circulate in the bloodstream until required or until they die (granulocytes), or migrate to the peripheral tissues where they differentiate further under the influence of tissue-specific factors (monocytes, mast cells, dendritic cells), or undergo further selection and differentiation in specialized compartments (e.g., T-cells undergo further maturation and quality control assessment in the thymus, see Chapter 10).

Myeloid cells comprise the majority of cells of the innate immune system

Macrophages and mast cells

Macrophages and **mast cells** are tissue-resident cells and are frequently the first dedicated immune cells to detect the presence of a pathogen (Figure 1.8). Both of these cell types have an **important role in sensing infection** and in amplifying immune responses, through the production of cytokines, chemokines, and other soluble mediators (such as vasoactive amines and lipids) that have effects on the local endothelium and facilitate the migration of other immune cells (such as neutrophils) to the

site of an infection through recruitment of the latter from the blood. Mast cells in particular have an important role in promoting vasodilation through production of histamine, which has profound effects on the local vasculature. Macrophages are derived from **monocyte** precursors that circulate in the bloodstream for a number of hours before exiting the circulation to take up residence in the tissues, where they undergo differentiation into specialized tissue macrophages.

Tissue macrophages have historically been given a variety of names based on their discovery through histological analysis of different tissues. Thus we have Kupffer cells in the liver, microglial cells in the brain, mesangial cells in the kidney, alveolar cells in the lung, osteoclasts in the bone, as well as a number of other macrophage types. Although macrophages do have tissue-specific functions, all tissue-resident macrophages are highly phagocytic, can kill ingested microbes, and can generate cytokines and chemokines upon engagement of their PRRs. We will discuss the specific functions of macrophages and mast cells later in this chapter.

Granulocytes

Neutrophils and their close relatives, **basophils** and **eosinophils**, which are collectively called **granulocytes** (Figure 1.9), are not tissue-resident but instead circulate in the bloodstream awaiting signals that permit their entry into the peripheral tissues. Neutrophils, which are also sometimes called polymorphonuclear neutrophils (PMNs), are by far the most numerous of the three cell types, making up almost 97% of the granulocyte population, and are highly phagocytic cells that are adept at hunting down and capturing extracellular bacteria and yeast. Neutrophils arrive very rapidly at the site of an infection, within a matter of a couple of hours after the first signs of infection are detected. Indeed, very impressive swarms of these cells migrate into infected tissues like a shoal of voracious piranha that can boast neutrophil concentrations up to 100-fold higher than are seen in the blood circulation (Figure 1.10).

Basophils and eosinophils have more specialized roles, coming into their own in response to large parasites such as helminth worms, where they use the constituents of their specialized granules (which contain histamine, DNAases, lipases, peroxidase, proteases, and other cytotoxic proteins, such as major basic protein) to attack and breach the tough outer cuticle of such worms. Because worm parasites are multicellular, they cannot be phagocytosed by macrophages or neutrophils but instead must be attacked with a **bombardment of destructive enzymes**. This is achieved through release of the granule contents of eosinophils and basophils (a process called **degranulation**) directly onto the parasite, a process that carries a high risk of collateral damage to host tissues. Basophils and eosinophils are also important sources of cytokines, such as IL-4, that have very important roles in shaping the nature of adaptive immune responses (discussed later in Chapter 8).

Granulocytes have relatively short half-lives (amounting to a day or two), most likely related to the powerful destructive

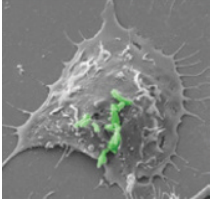
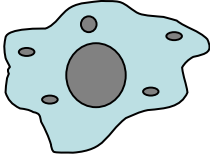
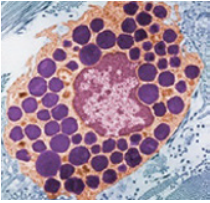
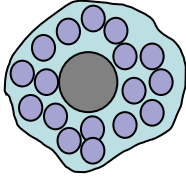
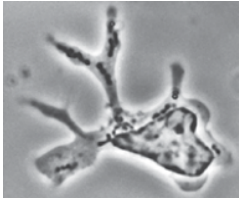
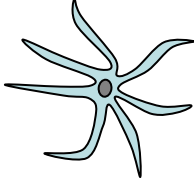
Macrophage		Effector function
		Phagocytosis / intracellular killing Cytokine production Antigen presentation NET formation
Mast cell		
		Histamine production Production of chemotactic factors Cytokine production
Dendritic cell		
		Antigen processing and presentation to T- cells Cytokine production/T-cell polarization

Figure 1.8 Macrophages, mast cells, and dendritic cells act as the sentinels of the innate immune system. Macrophages and mast cells play an important role in the initiation of innate immune responses through the liberation of inflammatory mediators and recruitment of additional cells (particularly neutrophils) to the site of infection. Macrophages also serve an important role as phagocytes in engulfing and killing microbes. Dendritic cells act as an important conduit between the innate and adaptive immune systems. Some of the major functions of these cells are shown (see main text for further details). NET, neutrophil extracellular trap. (Source: Macrophage image: Dr. Jean Pieters, University of Basel, Switzerland.)

enzymes that are contained within their cytoplasmic granules. These are the riot police of the immune system and, being relatively heavy-handed, are only called into play when there is clear evidence of an infection. Thus, the presence of granulocytes in a tissue is clear evidence that an immune response is underway. Egress of granulocytes from the circulation into tissues is facilitated by changes in the local endothelium lining blood vessels, instigated by vasoactive factors and cytokines/chemokines released by activated tissue macrophages and mast cells, which alter the adhesive properties of the lining of blood vessels closest to the site of infection. The latter changes, which include the upregulation of adhesion molecules on the surface of the local blood vessels, as well as the dilation of these vessels to permit the passage of cells and other blood-borne molecules more freely into the underlying tissue, facilitate the *extravasation* of granulocytes from the blood into the tissues.

Dendritic cells

Dendritic cells (DCs), which were among the first immune cell types to be recognized, are a major conduit between the innate and adaptive arms of the immune system. DCs have characteristic highly elaborated morphology (Figure 1.8), with multiple long

cellular processes (dendrites) that enable them to maximize contact with their surroundings. Although most DCs are tissue-resident cells with phagocytic capacity similar to macrophages, their primary role is not the destruction of microbes, but rather the *sampling of the tissue environment* through continuous *macropinocytosis* and *phagocytosis* of extracellular material. Upon detection and internalization of a PAMP (and its associated microbe) through phagocytosis, DCs undergo an important transition (called *DC maturation*) from a highly phagocytic but inefficient antigen-presenting cell into a lowly phagocytic but highly migratory DC that is now equipped to present antigen efficiently to T-cells within local lymph nodes. We will return to this subject later in this chapter, but the importance of the dendritic cell in the induction of adaptive immunity cannot be overstated.

Lymphoid cells comprise the majority of the cells of the adaptive immune system

T- and B-lymphocytes

Lymphocytes constitute ~20–30% of the leukocyte population and have a rather nondescript appearance (Figure 1.11), which belies their importance within the adaptive immune system.

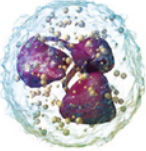

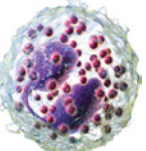

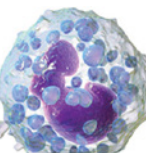

Neutrophil		Effector function
		Phagocytosis / intracellular killing Degranulation/ extracellular killing NET formation Cytokine production
Eosinophil		
		Parasite attack Degranulation/ extracellular killing Histamine production Cytokine production
Basophil		
		Parasite attack Degranulation/ extracellular killing Histamine production Cytokine production

Figure 1.9 Granulocytes form an important part of the innate immune system. Schematic representations of neutrophil, eosinophil, and basophil granulocytes are depicted along with their major functions. NET, neutrophil extracellular trap. (Source: Artistic impressions in the left panels © Blausen.com, with permission.)

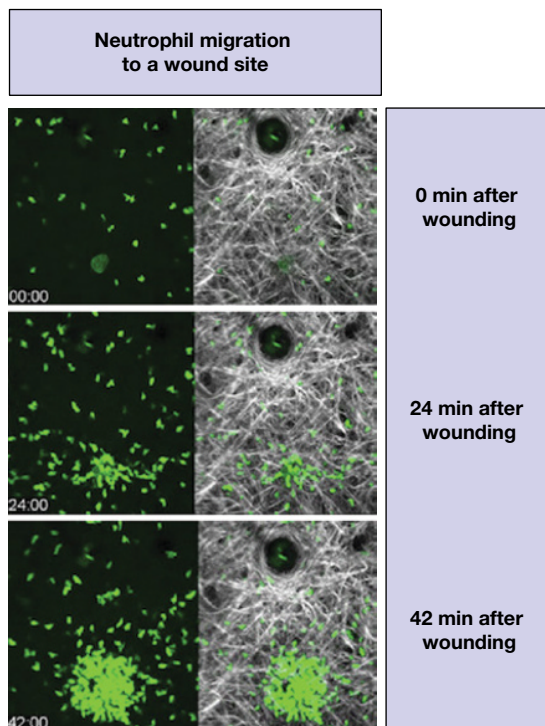


Figure 1.10 Neutrophils migrate in large numbers to sites of infection. Timelapse microscopy of neutrophils (green) migrating to a wound site. (Source: Dr. Tim Lämmermann, Max Planck Institute, Freiburg, Germany and Dr. Ron Germain, National Institute of Allergy and Infectious Disease, USA.)

As mentioned earlier, T- and B-lymphocytes are the central players in the adaptive immune system and have the ability to generate **highly specific cell surface receptors**, through genetic recombination of a relatively limited number of receptor precursors that are exquisitely specific for particular molecular structures, called antigens. In principle, T-cell receptors (TCRs) and B-cell receptors (BCRs, more commonly known as antibodies) can be generated to recognize practically any molecular structure (i.e., antigen), whether self- or nonself-derived. However, as we shall see in Chapters 4 and 10, lymphocyte receptors undergo a process of careful inspection after they have been generated to make sure that those that recognize self antigens (or indeed fail to recognize anything useful at all) are weeded out to ensure that the immune response does not become targeted against self (a state called autoimmunity). T- and B-lymphocytes also have the ability to undergo clonal expansion, which enables those lymphocytes that have generated useful (i.e., pathogen-specific) TCRs and BCRs to undergo rapid amplification, permitting the generation of large numbers of pathogen-specific T- and B-cells within 5–7 days of the initiation of an immune response. Specific T- and B-cells can also persist in the body for many years (called **memory cells**), which endows upon them the ability to “remember” previous encounters with particular pathogens and to rapidly mount a highly specific immune response upon a subsequent encounter with the same pathogen.

T-cells can be further subdivided into three broad subsets: helper (Th), cytotoxic (Tc), and regulatory (Treg) subsets that have roles in helping B-cells to make antibody (Th), killing

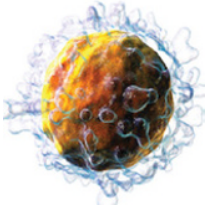
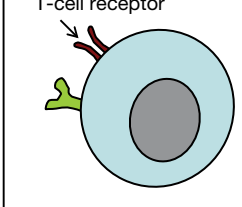
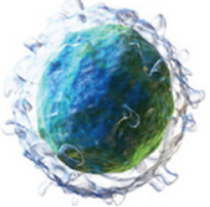
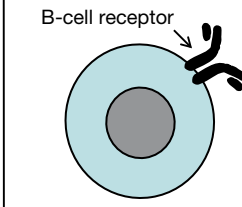
T-cell		Effector function
		Help for antibody production Killing of virus-infected cells Regulatory role
B-cell		
		Antibody production

Figure 1.11 T- and B-lymphocytes comprise the major lymphocytes of the adaptive immune system. Schematic representations of T- and B-lymphocytes are depicted along with their major functions. (Source: Artistic impressions in the left panels © Blausen.com, with permission.)

virally-infected cells (T_c) or policing the actions of other T-cells (T_{reg}). We will discuss T-cells and their different subsets extensively in Chapter 8.

Natural killer (NK) cells

NK cells, while also lymphocytes, play a major role within the innate immune system, although these cells also police the presence of special antigen-presenting molecules (called MHC molecules) that are expressed on virtually all cells in the body and play a key role in the operation of the adaptive immune system. NK cells use germline-encoded receptors (NK receptors) that are distinct from the receptors of T- and B-cells and are endowed with the ability to kill cells that express abnormal MHC receptor profiles. Viruses often interfere with MHC molecule expression as a strategy to attempt to evade the adaptive immune response, which solicits the attentions of NK cells and can lead to rapid killing of virally infected cells. NK cells also have receptors for a particular antibody class (IgG) and can use this receptor (CD16) to display antibody on their surface and in this way can seek out and kill infected cells, a process called *antibody-dependent cellular cytotoxicity*. We will discuss NK cells more extensively later in this chapter.

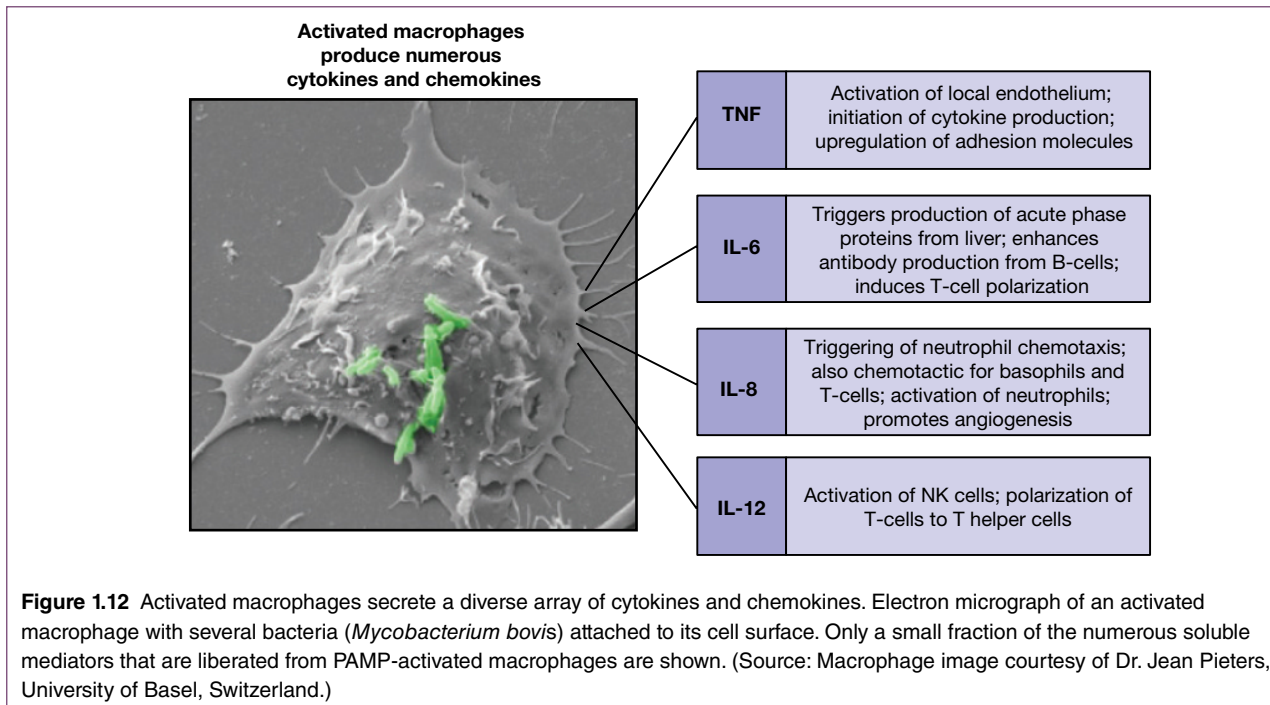
The beginnings of an immune response

Macrophages play an important role in instigating innate immune responses

As noted above, a major player in the initiation of immune responses is the *macrophage*. These cells are relatively abundant in most tissues (approaching 10–15% of the total cell

number in some areas of the body) and act as sentinels for infectious agent through an array of pathogen recognition receptors (PRRs) borne on their plasma membranes as well as other cellular compartments such as endosomes. Tissue macrophages are relatively quiescent cells, biding their time sampling the environment around them through continuous phagocytosis. However, upon entry of a microorganism that engages one or more of their PRRs (such as a Toll-like receptor or a NOD-like receptor), a startling transition occurs. Engagement of the PRR on the macrophage switches on a battery of genes that equip it to carry out a number of new functions (Figure 1.12).

First, the macrophage is put on a state of high alert (i.e., becomes activated) and is now better at engulfing and killing any microorganisms it encounters (this will be discussed in detail in the next section). Second, the macrophage begins to secrete cytokines and chemokines that have effects on nearby endothelial cells lining the blood capillaries; this *makes the capillaries in this area more permeable* than they would normally be. In turn, the *increased vascular permeability* permits two other things to happen. Plasma proteins that are normally largely restricted to blood can now invade the tissue at the point of infection and many of these proteins have microbicidal properties. A second consequence of increased vascular permeability is that *neutrophils* can now gain access to the site of infection. Recall from our earlier discussion that neutrophils, like macrophages, are also adept at phagocytosis but are normally not permitted to enter tissues owing to their potentially destructive behavior. Upon entry into an infected tissue, activated neutrophils proceed to attack and engulf any



microorganisms they encounter with gusto. We will deal with the specific mechanisms that neutrophils employ to attack and kill microbes later in this chapter.

The inflammatory response

Inflammation is the term given to the series of events that surround an immune response and display a number of characteristic features, including local swelling (edema), redness (due to capillary dilation), pain, and heat. These features are the collective consequence of the release of cytokines, chemokines, and vasoactive amines from macrophages and mast cells upon the initial encounter with a pathogen. Byproducts of complement activation (i.e., C3a and C5a), which will be discussed later, also contribute to the inflammatory response through promoting neutrophil chemotaxis, as well as activation of mast cells (Figure 1.13). All of these inflammatory mediators help to recruit neutrophils as well as plasma proteins to the site of infection by inducing vasodilation of the blood vessels close to the site of infection and by acting as chemotactic factors for neutrophils circulating in blood. The extra cells and fluid that gather at the site of an infection (which contribute to the swelling seen), the increased redness of skin tone in the area, and associated tenderness constitute the classic inflammatory reaction.

Mast cells collaborate with macrophages to promote vascular permeability

As we have already alluded to above, the macrophage plays a key role in the initiation of an inflammatory response through the secretion of cytokines and chemokines in response to

engagement of its PRRs and through encounter with opsonized microbes (Figure 1.12). However, another innate immune cell, the **mast cell**, is instrumental in provoking increased permeability of blood vessels due to release of the contents of the numerous cytoplasmic granules that such cells possess (Figure 1.8). Mast cell granules contain, among other factors, copious amounts of the vasoactive amino acid histamine (Figure 1.14). Mast cell degranulation can be provoked by direct injury, in response to complement components (C3a and C5a), encounter with PAMPs and through binding of specific antigen to a class of antibody (IgE) that binds avidly to mast cells via surface receptors (we will discuss antibody classes at length in Chapter 3). Histamine provokes dilation of postcapillary venules, activates the local endothelium, and increases blood vessel permeability. Irritation of nerve endings is another consequence of histamine release and is responsible for the pain often associated with inflammation, an evolutionary adaptation that most likely encourages the host to protect the infected or injured area to minimize further damage.

The relaxation induced in arteriolar walls causes increased blood flow and dilatation of the small vessels, whereas contraction of capillary endothelial cells allows exudation of plasma proteins. Under the influence of the chemotaxins, neutrophils slow down and the surface adhesion molecules they are stimulated to express cause them to marginate to the walls of the capillaries, where they pass through gaps between the endothelial cells (**diapedesis**) and move up the concentration gradient of chemotactic factors until they come face to face with **complement-opsonized** microbes (the details of complement-mediated opsonization will be discussed a little later in this

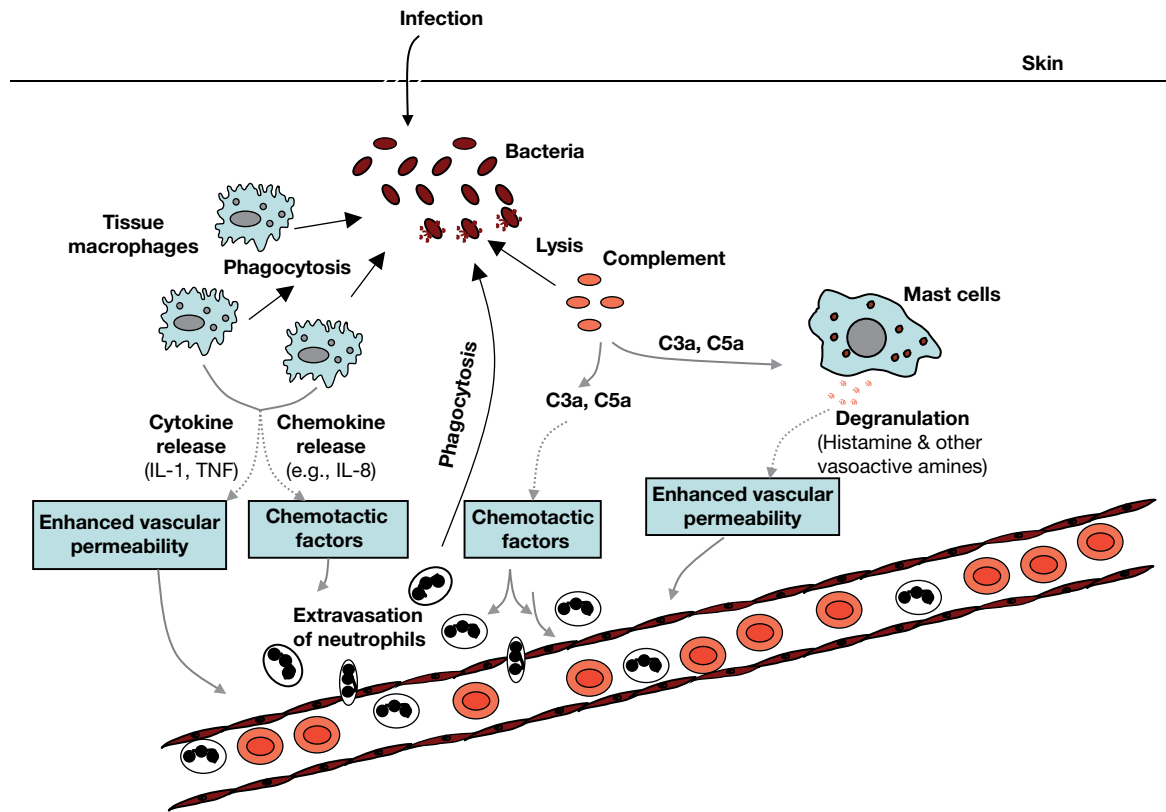


Figure 1.13 The acute inflammatory reaction. Bacterial infection initiates a series of responses through activation of the alternative complement pathway, producing C3a and C5a, as well as through stimulation of tissue-resident macrophages that detect bacterial-derived PAMPs. The C3b component of complement binds to bacteria, opsonizing the latter for more effective phagocytosis by macrophages and neutrophils. Complement activation can also lead to direct lysis of bacteria through assembly of membrane attack complexes. Activation of macrophages by PAMPs and complement components induces secretion of mediators (i.e., cytokines and chemokines) of the acute inflammatory response that increase vascular permeability and induce neutrophils to migrate from the blood into the tissue. C3a and C5a trigger mast cell activation and secretion of mediators that provoke capillary dilatation and exudation of plasma proteins. Attracted by C3a and C5a, as well as other factors, blood neutrophils stick to the adhesion molecules on the endothelial cell and use this to provide traction as they force their way between the cells, through the basement membrane (with the help of secreted elastase) and up the chemotactic gradient.

chapter). Adherence to the neutrophil complement (C3b) receptors then takes place, C3a and C5a (byproducts of complement activation which will be discussed later) at relatively high concentrations in the chemotactic gradient activate neutrophil killing mechanisms and, hey presto, the slaughter of the last act can begin!

Neutrophils are rapidly recruited to sites of infection

We have mentioned that the cytokines, chemokines, and vasoactive factors (such as histamine) that are released by activated macrophages and mast cells are instrumental in triggering neutrophil recruitment from the circulation into the site of infection, a process called *extravasation* (Figure 1.15). Because neutrophils are so numerous and so adept at phagocytosis, their recruitment to an inflammatory site is a critical step in innate immunity. So, let us take a look at this process in a little

more detail. Normally, neutrophils circulate in the bloodstream and are prevented from adhering to blood vessel walls owing to the rapid rate of movement of the blood within the vessels. To exit the bloodstream, neutrophils must first lightly adhere to and roll along the vessel wall until they gain a firm foothold that allows them to come to a stop, whereupon they initiate the process of squeezing between the endothelium. The cytokines secreted by activated macrophages, especially $\text{TNF}\alpha$ and $\text{IL-1}\beta$, have particular roles in this regard, as the latter cytokines increase the adhesiveness of the endothelial cells lining the blood capilleries closest to the site of infection through triggering the exposure of *P- and E-selectins* on these cells. The selectins present on the activated endothelium permit neutrophils to initiate the stopping process and to start rolling along the endothelial wall through binding interactions with carbohydrate ligands (e.g., sialyl-Lewis^x) present on the neutrophil cell surface (Figure 1.15).

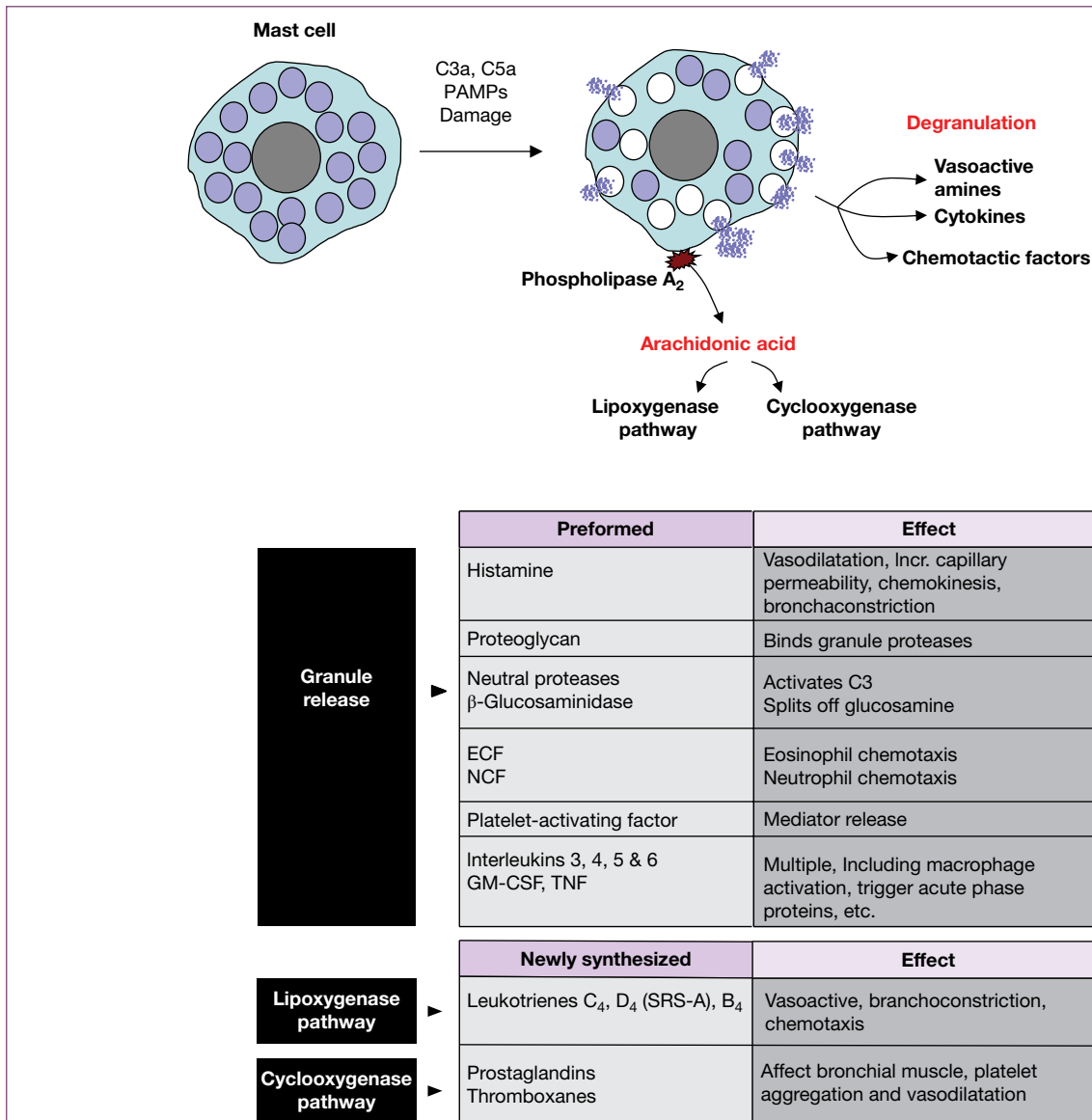


Figure 1.14 Mast cell triggering leading to release of mediators by two major pathways. (i) Release of preformed mediators present in the granules; and (ii) the metabolism of arachidonic acid produced through activation of a phospholipase. Intracellular Ca^{2+} and cyclic AMP are central to the initiation of these events but details are still unclear. Mast cell triggering may occur through C3a, C5a, and even by some microorganisms that can act directly on cell surface receptors. ECF, eosinophil chemotactic factor; GM-CSF, granulocyte–macrophage colony-stimulating factor; NCF, neutrophil chemotactic factor; TNF, tumor necrosis factor. Chemotaxis refers to directed migration of granulocytes up the pathway concentration gradient of the mediator.

At this stage, the neutrophil will also experience the chemotactic factors, such as IL-8 and complement products, that are emanating from the site of infection. These factors initiate the process of neutrophil activation, which triggers conformational changes in adhesion molecules called *integrins* (e.g., LFA-1, CR3) on the neutrophil surface that permits stronger interactions with their cognate *intercellular cell adhesion molecules* (ICAMs) receptors on the activated endothelium that arrests the neutrophil. Finally, neutrophils squeeze between the slightly wider gaps in the activated endothelium than normal (due to the

relaxation effects of histamine) and start to follow the gradient of chemotactic factors (IL-8, complement factors C3a and C5a) to its source. As we have seen earlier (Figure 1.10), this process is very efficient indeed and results in huge increases in neutrophil numbers at the site of infection within a matter of hours.

A similar process is also used to recruit *monocytes* from the bloodstream to reinforce their macrophage counterparts within the tissues, but this wave of recruitment usually takes place 6–8 hours after the peak of neutrophil extravasation and under the influence of a different chemokine, *monocyte chemotactic*

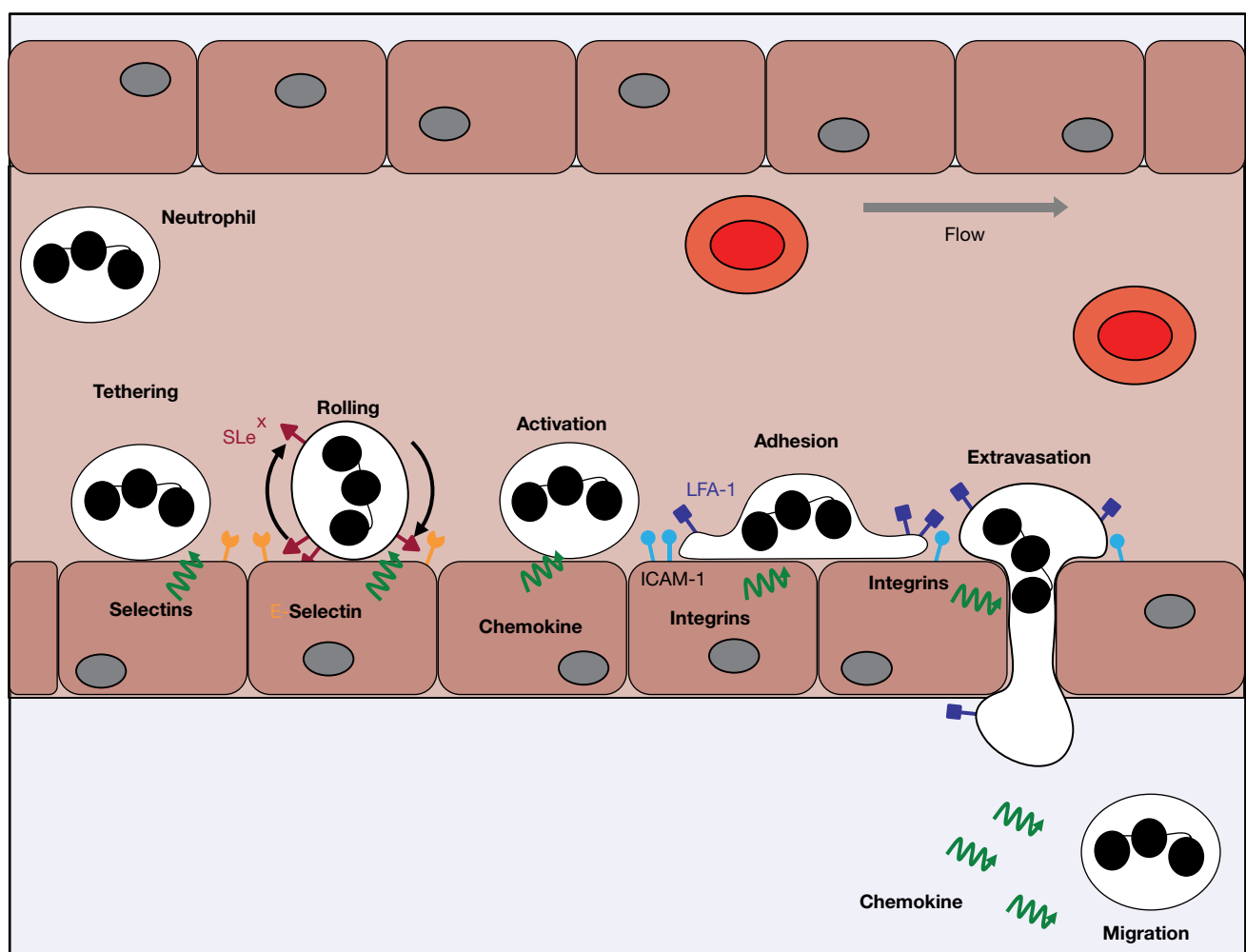


Figure 1.15 Neutrophil extravasation. Neutrophils are induced to migrate from blood vessels adjoining sites of infection through changes to the endothelial cells lining the blood vessels that are induced by the products of activated macrophages and mast cells, such as IL-1, TNF, IL-8, and histamine. Neutrophils initially loosely attach and roll along the endothelium mediated via sialyl-Lewis^x-mediated interactions with P- and E-selectins that are upregulated on the activated endothelium. Under the influence of chemokines, such as IL-8, neutrophils become activated, leading to activation of cell surface integrins (LFA-1, CR3) that provide firmer attachment to their cognate receptors (ICAMs) on the endothelium. The latter interactions enable neutrophils to arrest on the endothelial wall and to extravasate through the basement membrane of the endothelium and migrate into the tissue towards the source of chemotactic factors (IL-8, C3a, C5a).

protein-1 (MCP-1). Indeed, one of the reasons for the recruitment of extra monocytes (which differentiate into macrophages upon entering the tissues) is to help remove all of the battle-weary neutrophils, many of which will be stuffed to the gills with microbes, as well as other debris from the tissue and to initiate the process of *wound healing*.

There are several classes of pattern recognition receptors

PRRs on phagocytic cells recognize and are activated by PAMPs

Because the ability to discriminate friend from foe is of paramount importance for any self-respecting phagocyte, macrophages are fairly bristling with receptors capable of

recognizing diverse PAMPs. Many of the PRRs are also expressed on DCs, NK cells, neutrophils and mast cells, as well as cells of the adaptive immune system. Several of these PRRs are lectin-like and bind multivalently with considerable specificity to exposed microbial surface sugars with their characteristic rigid three-dimensional geometric configurations. They do not bind appreciably to the array of galactose or sialic acid groups that are commonly the penultimate and ultimate sugars that decorate mammalian surface polysaccharides, so providing the molecular basis for discriminating between self and nonself microbial cells. Other PRRs detect nucleic acids derived from bacterial and viral genomes by virtue of modifications not commonly found within vertebrate nucleic acids or conformations not normally found in the cytoplasm (e.g., double-stranded RNA).

PRRs are a diverse group of receptors that can be subdivided into at least five distinct families (TLRs, CLR, NLRs, RLRs, and scavenger receptors) based upon structural features. Another class of sensors has also emerged in recent years, the cytosolic DNA sensors (CDSs), which contains a structurally diverse set of cytosolic DNA-sensing receptors that are predominantly involved in detecting intracellular bacteria and viruses. Multiple receptors also exist in each class, with the result that in excess of 50 distinct PRRs may be expressed by a phagocyte at any given time.

Cell-associated PRRs decode the nature of infection

As noted earlier, there are several classes of cell-associated PRRs, some of which are plasma membrane-associated (e.g., many of the Toll-like receptors as well as the C-type lectin receptors and scavenger receptors), some of which face the luminal space of endosomes (TLR3, 7, 8, 9) and some of which are cytoplasmic (NOD-like receptors, RIG-I-like receptors, cytoplasmic DNA sensors). In general terms, each PRR is specific for a distinct PAMP and, combined with the different cellular compartments that PRRs reside in, this conveys considerable information concerning the nature of the pathogen and whether it is extracellular, has been captured through phagocytosis (i.e., is within endosomes) or has invaded the cytoplasm. This information helps to tailor the response towards what will be most effective for the particular class of pathogen by influencing the nature of the cytokines that are produced by the responding cell.

Engagement of several categories of PRR simultaneously may be required for effective immune responses

Although this is an area of ongoing research, **combinatorial PRR signaling** is probably very important for the initiation of effective immune responses. Thus, the triggering of a single type of PRR, in a DC for example, may not be fully effective for the initiation of a robust adaptive immune response, as this could indicate either a low level of infection, or that the DC is at a considerable distance from the site of infection (and has simply encountered a few stray PAMPs that have been released owing to lysis of the infectious agent). However, **phagocytosis of a single bacterium by a DC is likely to stimulate multiple categories of PRR simultaneously**, leading to synergistic activation of several signal transduction pathways, thereby signifying that a robust response is warranted. Furthermore, it is likely that engagement of different combinations of PRRs underpins the different types of immune response that are required to successfully contain different types of infection: intracellular, extracellular, large parasite, yeast, bacterial, viral, etc.

As we shall see throughout this book, delivery of two (or more) different signals in tandem is a common theme in immune reactions and can lead to very different outcomes compared with delivery of either signal on its own. We will now look at the various PRR families in more detail.

Toll-like receptors (TLRs)

A major subset of the PRRs belong to the **Toll-like receptor (TLR) family**, named on the basis of their similarity to the Toll receptor in the fruit fly, *Drosophila*. The history of the discovery of the TLR family is interesting, as it perfectly illustrates the serendipitous nature of scientific discovery and illustrates how very important findings can originate in the most unlikely places. Lipopolysaccharide (LPS, also called endotoxin), a major component of the cell walls of Gram-negative bacteria, was long known to provoke strong immune responses in animals and is a good example of a classical PAMP. Indeed, LPS is one of the major contributors to septic shock, the severe immune reaction that results when a bacterial infection reaches the bloodstream, and which is often fatal. For these reasons, immunologists tried to identify the LPS receptor in human and mouse for many years, largely without success. However, a major breakthrough came when the Toll receptor was found to be involved in sensing microbial infection in adult fruit flies. This in itself was quite a surprise because the Toll receptor had already been identified, many years before, as a major regulator of dorsal-ventral patterning (i.e., specifying which surface of the fly is the back and which is the underside) during early embryonic development of *Drosophila*. A curious fact that emerged was that the intracellular domain of *Drosophila* Toll contained a motif, now known as the Toll/IL-1 receptor (TIR) signaling motif, that was very similar to the cytoplasmic signaling domain identified in the IL-1 receptor, a molecule that was already well known to be involved in immune signaling in mammals. Putting two and two together, this led to the identification of the whole TLR family in mammals, as these receptors all possess a TIR domain within their cytoplasmic regions.

A series of TLRs have now been identified (there are 10 distinct TLRs in humans), all of which act as sensors for PAMPs (Figure 1.16). TLR ligands include peptidoglycan, lipoproteins, mycobacterial lipoarabinomannan, yeast zymosan, flagellin, microbial DNA, microbial RNAs, as well as other pathogen-derived ligands (Table 1.1). Although many TLRs are displayed on the cell surface, some, such as TLR3 and TLR7/8/9 that are responsive to intracellular viral RNA and unmethylated bacterial DNA, are located in endosomes and become engaged upon encounter with phagocytosed material (Figure 1.16). Engagement of TLRs with their respective ligands drives activation of nuclear factor κ B (NF κ B) and several members of the interferon-regulated factor (IRF) family of transcription factors, depending on the specific TLR. Combinatorial activation of TLRs is also possible, for example TLR2 is capable of responding to a wide diversity of PAMPs and typically functions within heterodimeric TLR2/TLR1 or TLR2/TLR6 complexes (Table 1.1).

All TLRs have the same basic structural features, with multiple N-terminal leucine-rich repeats (LRRs) arranged in a horseshoe- or crescent-shaped solenoid structure that acts as the PAMP-binding domain (Figure 1.17). Upon binding of a

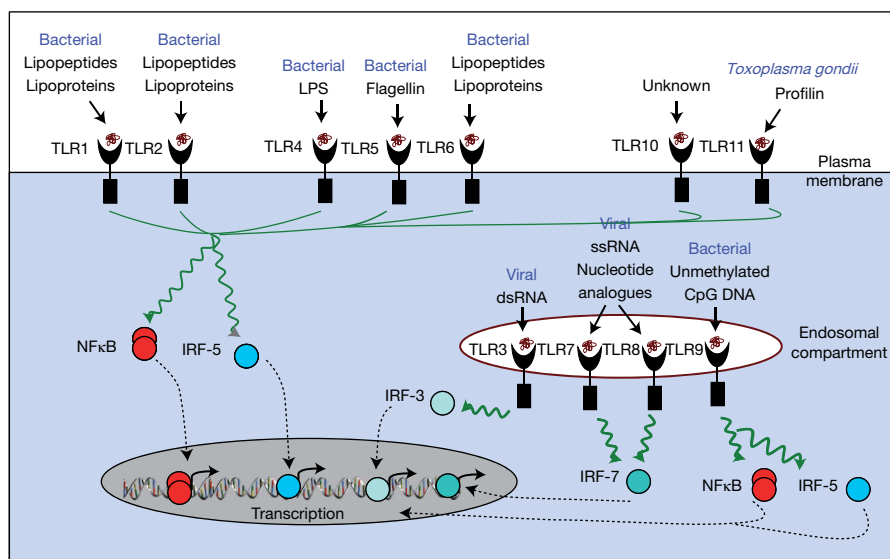


Figure 1.16 A family of Toll-like receptors (TLRs) act as sensors for pathogen-associated molecular patterns (PAMPs). TLRs reside within plasma membrane or endosomal membrane compartments, as shown. Upon engagement of the TLR ectodomain with an appropriate PAMP (some examples are shown), signals are propagated into the cell that activate the nuclear factor κ B (NF κ B) and/or interferon-regulated factor (IRF) transcription factors, as shown. NF κ B and IRF transcription factors then direct the expression of numerous antimicrobial gene products, such as cytokines and chemokines, as well as proteins that are involved in altering the activation state of the cell.

Table 1.1 Ligands for Toll-like receptors (TLRs).

TLR	Ligand	Location
TLR1/ TLR2 heterodimer	Bacterial lipopeptides	Plasma membrane
TLR2/TLR6 heterodimer	Lipoteichoic acid (Gram-positive bacteria), zymosan (fungi)	Plasma membrane
TLR3	dsRNA	Endosomal
TLR4	LPS	Plasma membrane
TLR5	Flagellin (motile bacteria)	Plasma membrane
TLR7	Viral ssRNA	Endosomal
TLR8	Viral ssRNA	Endosomal
TLR9	Unmethylated CpG DNA (bacterial)	Endosomal
TLR10	Unknown	Plasma membrane
TLR11 (mouse only)	Profilin and profilin-like proteins	Plasma membrane

PAMP, TLRs transduce signals into the cell via their TIR domains, which recruit adaptor proteins within the cytoplasm (such as MyD88) that possess similar TIR motifs. These adaptors propagate the signal downstream, culminating in activation

of NF κ B and interferon regulatory family (IRF) transcription factors, which regulate the transcription of a whole battery of inflammatory cytokines and chemokines (Figure 1.16 and Figure 1.18). As we will discuss later in this chapter, the IRF transcription factors control the expression of, among other things, type I interferons. The latter cytokines are especially important in defense against viral infections as they can induce the expression of a series of proteins that can interfere with viral mRNA translation and viral replication, as well as induce the degradation of viral RNA genomes.

C-type lectin receptors (CTLRs)

Phagocytes also display another set of PRRs, the cell-bound **C-type (calcium-dependent) lectins**, of which the macrophage mannose receptor is an example. Other members of this diverse and large family include Dectin-1, Dectin-2, Mincle, DC-SIGN, Clec9a, and numerous others. These transmembrane proteins possess multiple carbohydrate recognition domains whose engagement with their cognate microbial PAMPs generates intracellular activation signals through a variety of signaling pathways. However, some C-type lectin receptors (CTLRs) do not trigger robust transcriptional responses and function primarily as phagocytic receptors. The CTLR family is highly diverse and the ligands for many receptors in this category are the subject of ongoing research. But it can be said that members of the CTLR family broadly serve as sensors for extracellular fungal species. Some examples of ligands for CTLRs include β -glucans (which binds Dectin-1), mannose (which binds Dectin-2), and α -mannose (which binds Mincle).

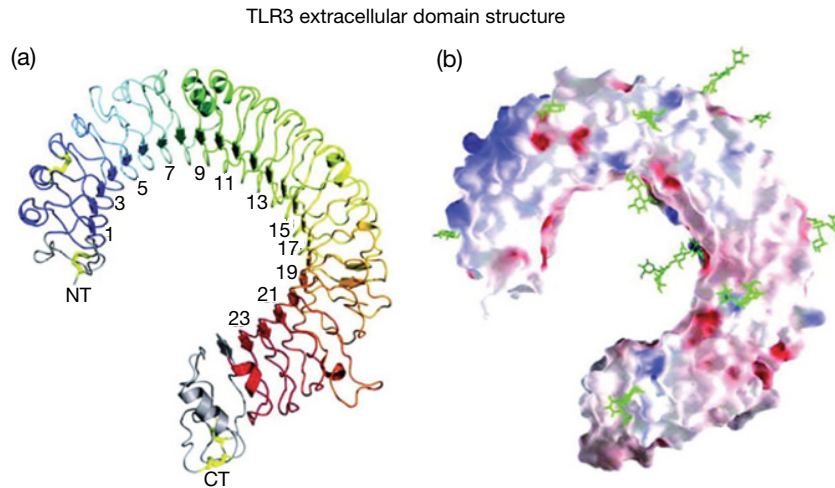


Figure 1.17 Toll-like receptor (TLR) structure. TLR3 ectodomain structure. (a) Ribbon diagram. Leucine-rich repeats (LRRs) are colored from blue to red, beginning at LRR1 and proceeding to LRR23, as indicated. NT, N-terminus; CT, C-terminus. (b) Electrostatic potential surface shows positive (blue) and negative (red) charges at neutral pH. The N-linked glycans are shown as green ball-and-stick. (Source: Bell J.K. *et al.* (2005) *Proceedings of the National Academy of Sciences USA* **102**, 10976–10980. Reproduced with permission.)

NOD-like receptors (NLRs)

Turning now to the sensing of infectious agents that have succeeded in gaining access to the interior of a cell, microbial products can be recognized by the so-called NOD-like receptors (NLRs). Unlike TLRs and CTLRs that reside within the plasma membrane or intracellular membrane compartments, NLRs are soluble proteins that reside in the cytoplasm, where they also act as receptors for PAMPs. Although a diverse family of receptors (Figure 1.19), NLRs typically contain an N-terminal protein–protein interaction motif that enables these proteins to recruit proteases or kinases upon activation, followed by a central oligomerization domain and multiple C-terminal leucine-rich repeats (LRRs) that act as the sensor for pathogen products (Figure 1.19). The NLRs can be subdivided into four subfamilies on the basis of the motifs present at their N-termini. NLRs are thought to exist in an autoinhibited state with their N-terminal domains folded back upon their C-terminal LRRs, a conformation that prevents the N-terminal region from interacting with its binding partners in the cytoplasm. Activation of these receptors is most likely triggered through direct binding of a PAMP to the C-terminal LRRs which has the effect of disrupting the interaction between the N- and C-termini of the NLR and permits oligomerization into a complex that is now capable of recruiting either an NF κ B-activating kinase (such as RIP-2) or members of the caspase family of proteases that can proteolytically process and activate the IL-1 β precursor into the mature, biologically active cytokine.

A very well-studied NLR complex, called *the inflammasome*, is assembled from NLRP3 in response to LPS in combination with bacterial virulence factors, and is important for the production of IL-1 β as well as IL-18. However, for full activation of the inflammasome and liberation of IL-1 β , a second signal in the form of a membrane-damaging bacterial toxin

(which can also be mimicked by a variety of noxious agents) is required. This second signal appears to permit the efflux of K⁺ ions from the cytosol, which permits full assembly of the inflammasome, caspase-1 activation, and processing of IL-1 β and IL-18 downstream (Figure 1.20).

RIG-I-like helicase receptors (RLRs)

The RIG-I-like helicases are a relatively recently discovered family that act as intracellular sensors for viral-derived RNA (Figure 1.21). Similar to the NLRs, RIG-I-like helicase receptors (RLRs) are found in the cytoplasm and are activated in response to double-stranded RNA and are capable of directing the activation of NF κ B and IRF3/4 that cooperatively induce antiviral type I interferons (IFN α and β). RIG-I (retinoic acid-inducible gene I) and the related MDA-5 (also called Helicard) protein can directly bind to different forms of viral RNA (either unmodified 5'-triphosphate ssRNA or dsRNA, respectively) in the cytoplasm, followed by propagation of their signals via MAVS (mitochondrial-associated viral sensor), again leading to activation of IRFs and NF κ B (Figure 1.22).

Cytosolic DNA sensors

A number of proteins belonging to different families are capable of sensing cytosolic DNA or cyclic dinucleotides. Host cell DNA is normally sequestered safely in the nuclear or mitochondrial compartments and cannot trigger these sensors, except under pathological conditions that involve release of mitochondrial DNA into the cytosol, for example. However, bacterial or viral DNA can trigger the activation of the *AIM2* or *IFI16* DNA sensors and this can lead to assembly of a complex involving the Pyrin-domain-containing adaptor (ASC), leading to activation of caspase-1 and IL-1 β processing.

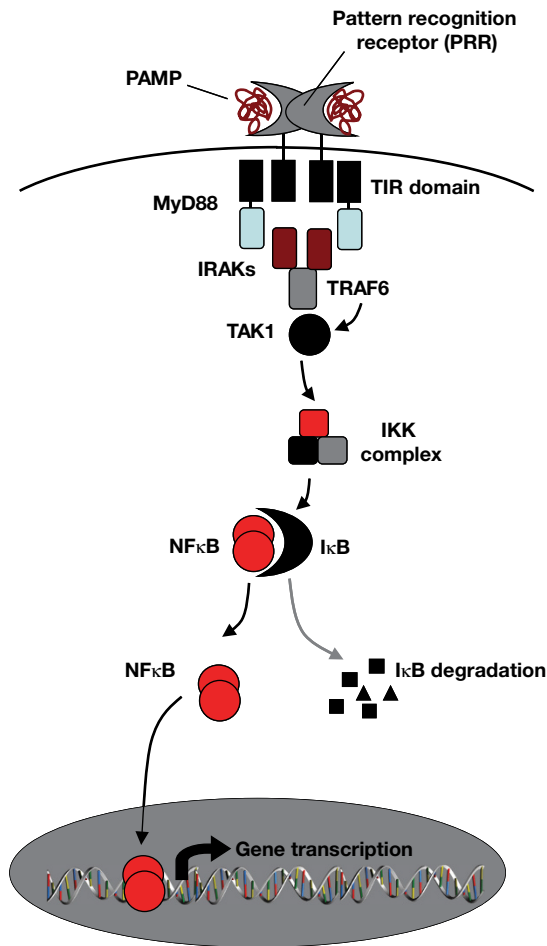


Figure 1.18 Toll-like receptors promote NFκB-dependent transcription through activation of the IκB kinase (IKK) complex. Upon engagement of a TLR dimer (or heterodimer) with its appropriate ligand, a series of adaptor proteins (as shown) are recruited to the TLR receptor Toll and IL-1 receptor-like (TIR) domain. Collectively, these proteins activate the IKK complex, which in turn phosphorylates the inhibitor of NFκB (IκB), a protein that binds and tethers NFκB in the cytosol. IκB phosphorylation targets the latter for degradation, liberating NFκB which can then translocate into the nucleus and initiate transcription of multiple genes.

Activation of the *AIM2 inflammasome* can also lead to death of the cell. IFI16 can also recognize cytosolic DNA and can either propagate signaling by forming a complex with ASC and caspase-1, similar to the AIM2 inflammasome, or via STING, which is discussed below. Two additional DNA-sensing pathways have also been discovered very recently and both make use of *STING* (stimulator of interferon genes) a molecule that can either directly bind to cytoplasmic DNA or can respond to cyclic GAMP, a molecule that is generated by an upstream enzyme called cGAS, which detects cytoplasmic DNA and synthesizes cGAMP in response (Figure 1.23). In response to STING activation, type I IFNs are generated which have potent antiviral properties.

Scavenger receptors

Scavenger receptors represent yet a further class of phagocytic receptors that recognize a variety of anionic polymers and acetylated low-density proteins. The role of the CD14 scavenger molecule in the handling of Gram-negative LPS (lipopolysaccharide endotoxin) merits some attention, as failure to do so can result in septic shock. The biologically reactive lipid A moiety of LPS is recognized by a plasma LPS-binding protein, and the complex that is captured by the CD14 scavenger molecule on the phagocytic cell then activates TLR4. However, unlike the PRRs discussed above, engagement of scavenger receptors are typically insufficient on their own to initiate cytokine activation cascades.

PRR engagement results in cell activation and proinflammatory cytokine production

Upon encountering ligands of any of the aforementioned PRRs, the end result is a switch in cell behavior from a quiescent state to an activated one. Activated macrophages and neutrophils are capable of phagocytosing particles that engage their PRRs and, as we have seen from our discussion of the various classes of PRRs, upon engagement of the latter they also release a range of cytokines and chemokines that amplify the immune response further (see Figure 1.12). As the reader will no doubt have noticed, engagement of many of the above PRRs results in a signal transduction cascade culminating in activation of NFκB, a transcription factor that controls the expression of numerous immunologically important molecules such as cytokines and chemokines. In resting cells, NFκB is sequestered in the cytoplasm by its inhibitor IκB, which masks a nuclear localization signal on the former. Upon binding of a PAMP to its cognate PRR, NFκB is liberated from IκB because of the actions of a kinase that phosphorylates IκB and promotes its destruction. NFκB is now free to translocate to the nucleus, seek out its target genes, and initiate transcription (see Figure 1.18).

Some of the most important inflammatory mediators synthesized and released in response to PRR engagement include the antiviral *interferons (also called type I interferons)*, the small protein cytokines IL-1β, IL-6, IL-12, and tumor necrosis factor α (TNFα), which activate other cells through binding to specific receptors, and chemokines, such as IL-8, which represent a subset of chemoattractant cytokines. Collectively, these molecules amplify the immune response further and have effects on the local blood capillaries that permit extravasation of neutrophils, which come rushing into the tissue to assist the macrophage in dealing with the situation (see Figure 1.15).

Dying cells also release molecules capable of engaging PRRs

As we have mentioned earlier, cells undergoing necrosis (but not apoptosis) are also capable of releasing molecules (i.e., DAMPs) that are capable of engaging PRRs (see Figure 1.3). The identity of these molecules is only slowly emerging,

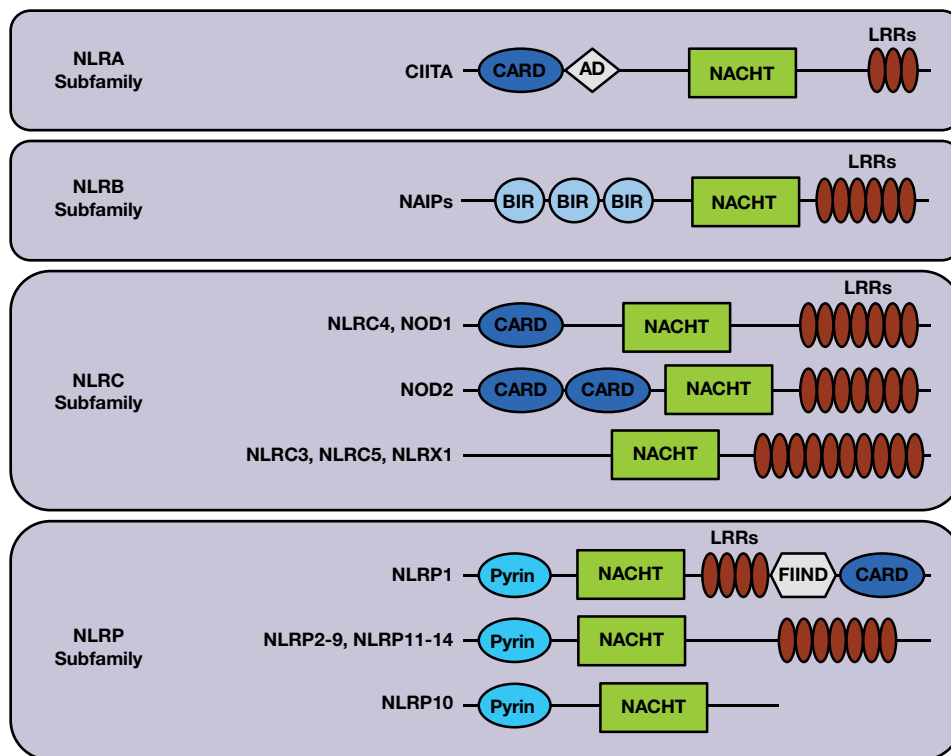


Figure 1.19 Domain organization of the NOD-like receptor (NLR) family. The four subfamilies of NLRs are depicted, separated primarily on the basis of their usage of different N-terminal domains (AD, CARD, Pyrin, BIR) that confers unique functional roles on each NLR. All of the NLRs contain a central NACHT domain, which is a motif that permits oligomerization of individual NLRs into supercomplexes. Assembly and activation of NLR complexes is induced through ligand binding to the C-terminal LRRs that serve as a sensor domain for each of the NLRs. AD, acidic transactivation domain; CARD, caspase recruitment domain; BIR, baculoviral IAP repeat; FIIND, function to find domain; LRR, leucine-rich repeat.

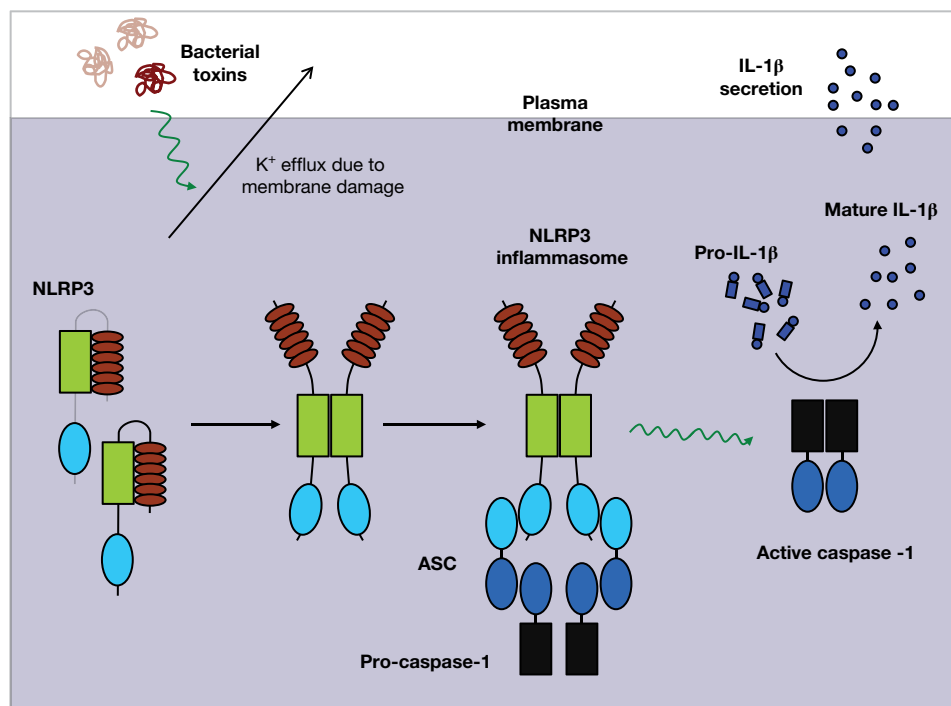


Figure 1.20 Activation of the NLRP3 inflammasome leads to caspase-1 activation and IL-1 β processing and release. One example of an NLR complex is illustrated by the NLRP3 inflammasome that is assembled in response to two different signals. Signal 1 is represented by LPS, a PAMP that binds to TLR4 thereby inducing IL-1 β transcriptional upregulation in an NF κ B-dependent manner (not shown). However, a second signal is required for IL-1 β processing and release and this is provided by the cytotoxic actions of bacterial toxins that permit K⁺ efflux, through damaging the plasma membrane of an LPS-primed cell. It is the latter event (i.e., K⁺ efflux) that triggers assembly of the NLRP3 inflammasome, leading to caspase-1 activation, IL-1 β processing, and release of the latter cytokine through death of the injured cell. Thus, the NLRP3 inflammasome acts as a sensor for cell injury-associated K⁺ efflux.

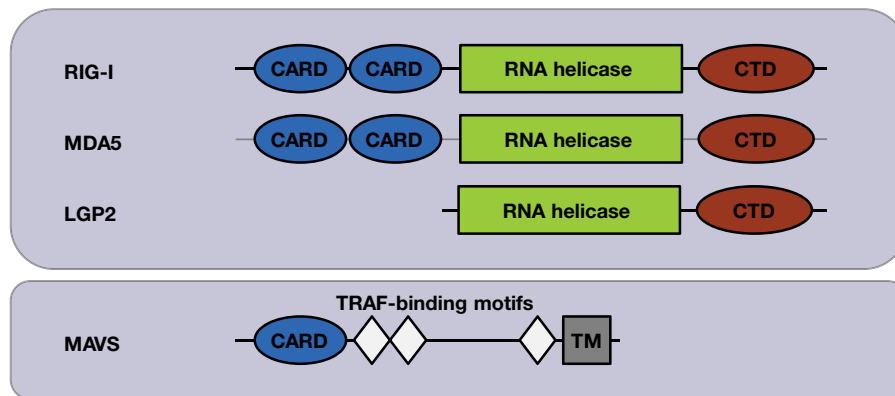


Figure 1.21 Domain organization of the RIG-I-like receptors and their common adaptor MAVS. Members of the RIG-I-like helicase family that act as cytoplasmic sensors for viral RNA are shown, along with their common adaptor protein MAVS. See also Figure 1.22.

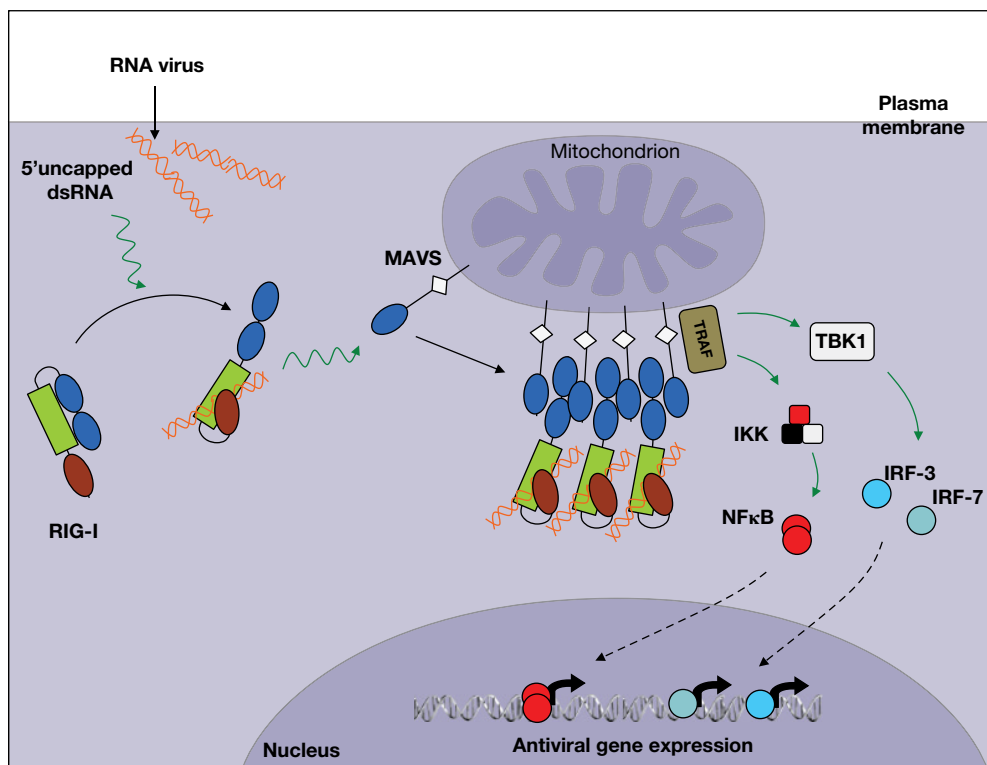


Figure 1.22 RIG-I is activated by double-stranded RNA and initiates transcription of antiviral genes via the IRF and NFκB pathways. RIG-I (retinoic acid inducible gene 1) acts as a cytoplasmic sensor for viral RNA and detects 5'-triphosphate uncapped dsRNA or ssRNA molecules. Upon binding of viral RNA, RIG-I, which is normally in an autoinhibited conformation, can then bind to MAVS (mitochondrial antiviral signaling protein) via CARD–CARD interactions with the latter to promote activation of IRF and NFκB-dependent gene transcription, as shown. CARD, caspase recruitment domain.

but includes HMGB1, members of the S100 calcium-binding protein family, HSP60 and the classical cytokines IL-1α and IL-33. Certain DAMPs appear to be able to bind to members of the TLR family (i.e., HMGB1 has been suggested to signal via TLR4), while others such as IL-1α and IL-33 bind to

specific cell surface receptors that possess similar intracellular signaling motifs to the TLR receptors.

DAMPs are involved in amplifying immune responses to infectious agents that provoke cell death and also play a role in the phenomenon of *sterile injury*, where an immune response

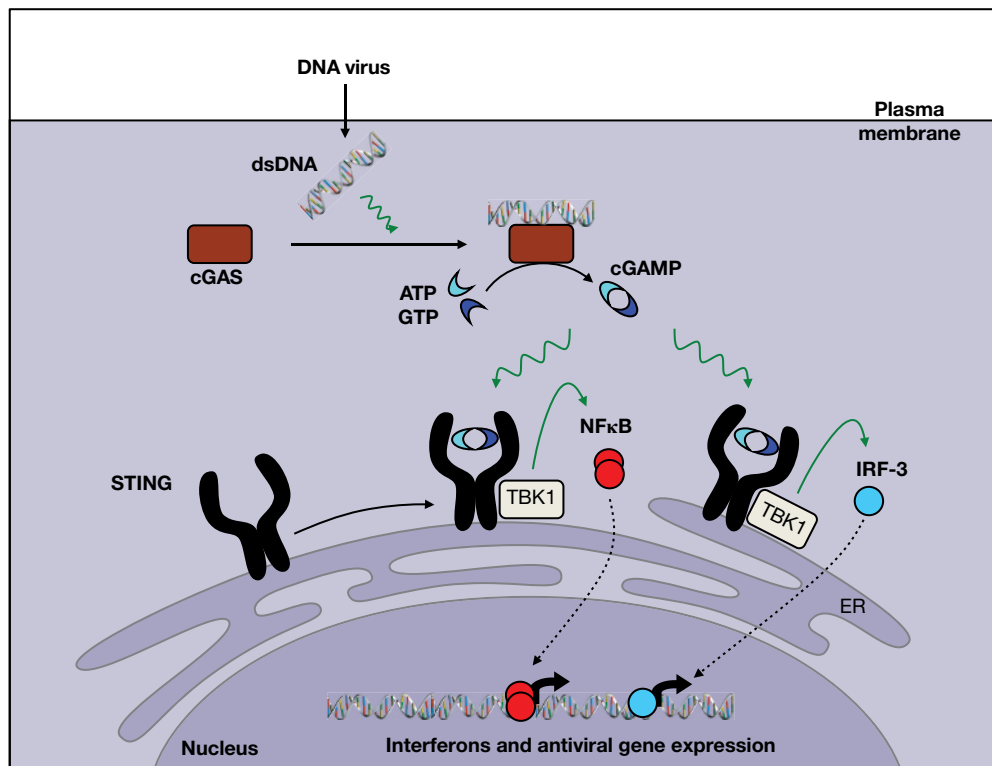


Figure 1.23 STING acts as a cytoplasmic sensor for DNA and cyclic nucleotides. STING (stimulator of interferon genes) is an endoplasmic reticulum-associated protein that can sense cytoplasmic DNA either directly, or through DNA binding to cGAS (cyclic GMP–AMP synthase) an enzyme that generates unusual cyclic dinucleotides (cGAMP) that can act as a ligand for STING to activate transcription of IRF and NFκB-dependent gene transcription. STING may also be able to sense cyclic dinucleotides that are produced by intracellular bacteria.

occurs in the absence of any discernable infectious agent (e.g., the bruising that occurs in response to a compression injury that does not breach the skin barrier represents an innate immune response). Indeed, Polly Matzinger has proposed that robust immune responses are only seen when nonself is detected in combination with tissue damage (i.e., a source of DAMPs). The thinking here is that the immune system does not need to respond if an infectious agent is not causing any harm. Thus, PAMPs and DAMPs may act synergistically to provoke more robust and effective immune responses than would occur in response to either alone.



Phagocytic cells engulf and kill microorganisms

Macrophages and neutrophils are dedicated “professional” phagocytes

The engulfment and digestion of microorganisms are assigned to two major cell types recognized by Elie Metchnikoff at the turn of the last century as microphages (now known as neutrophils) and macrophages.

The macrophage

These cells derive from bone marrow promonocytes that, after differentiation to blood monocytes, finally settle in the tissues as mature macrophages where they constitute the *mononuclear phagocyte system* (Figure 1.24). They are present throughout the connective tissue and around the basement membrane of small blood vessels and are particularly concentrated in the lung (alveolar macrophages), liver (Kupffer cells), and lining of spleen sinusoids and lymph node medullary sinuses, where they are strategically placed to filter off foreign material. Other examples are mesangial cells in the kidney glomerulus, brain microglia, and osteoclasts in bone. Unlike neutrophils, macrophages are long-lived cells with significant rough-surfaced endoplasmic reticulum and mitochondria and, whereas neutrophils provide the major defense against pyogenic (pus-forming) bacteria, as a rough generalization it may be said that macrophages are at their best in combating those bacteria, viruses, and protozoa that are capable of living within the cells of the host.

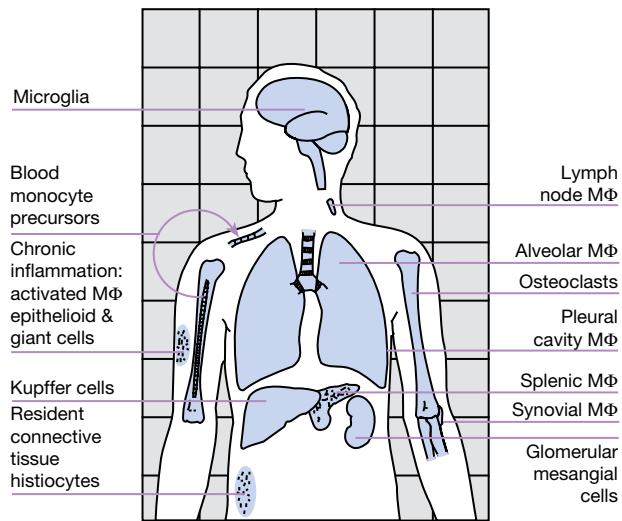


Figure 1.24 The mononuclear phagocyte system. Promonocyte precursors in the bone marrow develop into circulating blood monocytes that eventually become distributed throughout the body as mature macrophages (M Φ) as shown. The other major phagocytic cell, the polymorphonuclear neutrophil, is largely confined to the bloodstream except when recruited into sites of acute inflammation.

The polymorphonuclear neutrophil

This cell, the smaller of the two, shares a common hematopoietic stem cell precursor with the other formed elements of the blood and is the dominant white cell in the bloodstream. It is a nondividing short-lived cell with a multilobed nucleus and an array of granules (Figure 1.9 and Figure 1.25), which are virtually unstained by histologic dyes such as hematoxylin and eosin, unlike those structures in the closely related eosinophil and basophil (Figure 1.9). Neutrophil granules are of two main types: (i) the **primary azurophil granule** that develops early, has the typical lysosomal morphology and contains myeloperoxidase, together with most of the nonoxidative antimicrobial effectors including defensins, bactericidal permeability increasing (BPI) protein, and cathepsin G (Figure 1.25); and (ii) the peroxidase-negative **secondary specific granules** containing lactoferrin, much of the lysozyme, alkaline phosphatase and membrane-bound cytochrome b_{558} (Figure 1.25). The abundant glycogen stores can be utilized by glycolysis, enabling the cells to function under anerobic conditions.

Microbes are engulfed by activated phagocytic cells

After adherence of the microbe to the surface of the neutrophil or macrophage through recognition of a PAMP (Figure 1.26b), the resulting signal (Figure 1.26c) initiates the ingestion phase by activating an actin–myosin contractile system that extends pseudopods around the particle (Figure 1.26d and Figure 1.27); as adjacent receptors sequentially attach to the surface of the

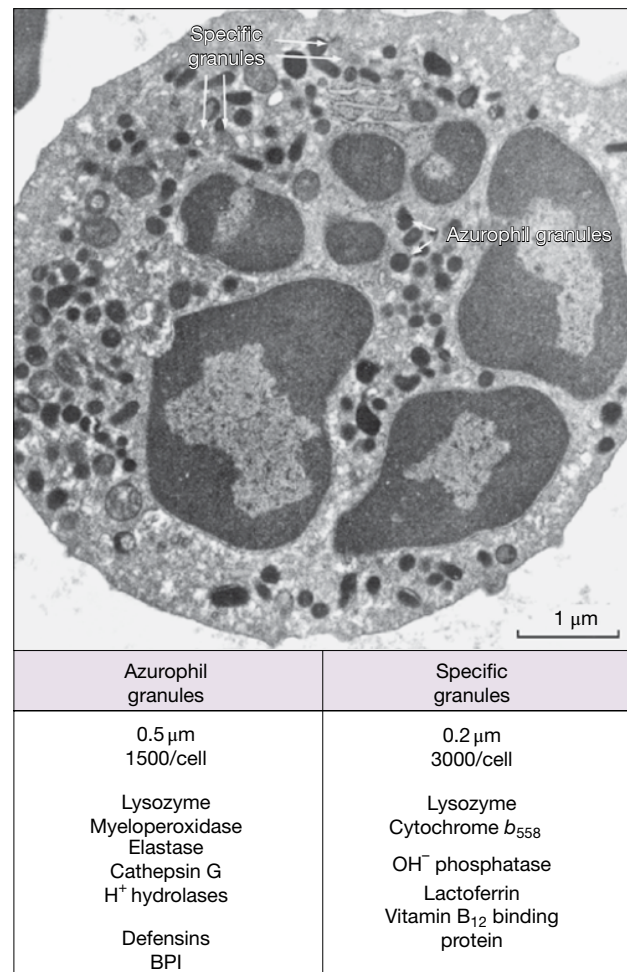


Figure 1.25 Ultrastructure of neutrophil. The multilobed nucleus and two main types of cytoplasmic granules are well displayed. BPI, bactericidal permeability increasing protein. (Source: Dr. D. McLaren. Reproduced with permission.)

microbe, the plasma membrane is pulled around the particle just like a “zipper” until it is completely enclosed in a vacuole (phagosome; Figure 1.26f and Figure 1.27). Events are now moving smartly and, within 1 minute, the cytoplasmic granules fuse with the phagosome and discharge their contents around the imprisoned microorganism (Figure 1.26g and Figure 1.28) subjecting them to a formidable battery of microbicidal mechanisms.

Phagocytes employ an array of killing mechanisms

Killing by reactive oxygen intermediates

Trouble starts for the invader from the moment phagocytosis is initiated. There is a dramatic increase in activity of the hexose monophosphate shunt, generating reduced nicotinamide adenine dinucleotide phosphate (NADPH). Electrons pass from the NADPH to a flavine adenine dinucleotide (FAD)-containing

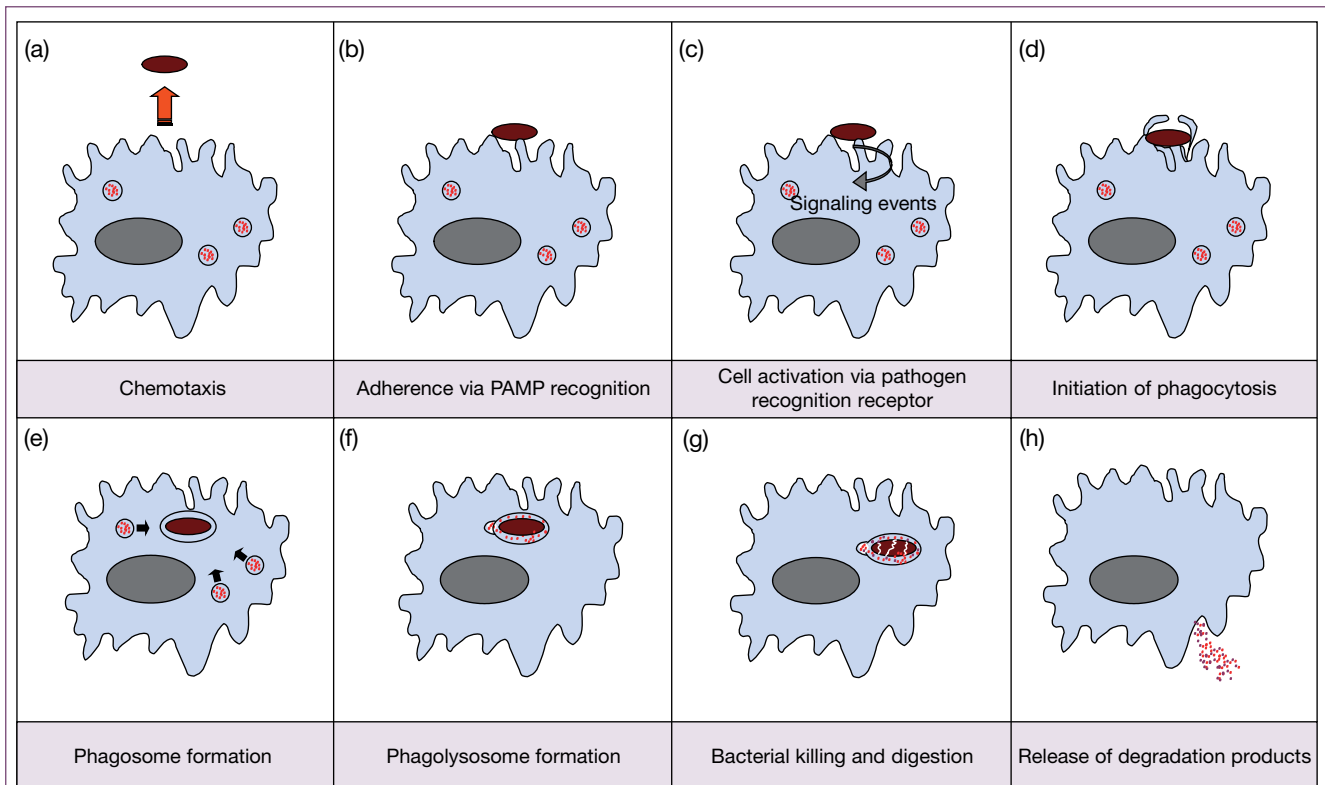


Figure 1.26 Phagocytosis and killing of a bacterium. Stage c/d, respiratory burst and activation of NADPH oxidase; stage e, damage by reactive oxygen intermediates; stage f/g, damage by peroxidase, cationic proteins, antibiotic peptide defensins, lysozyme, and lactoferrin.

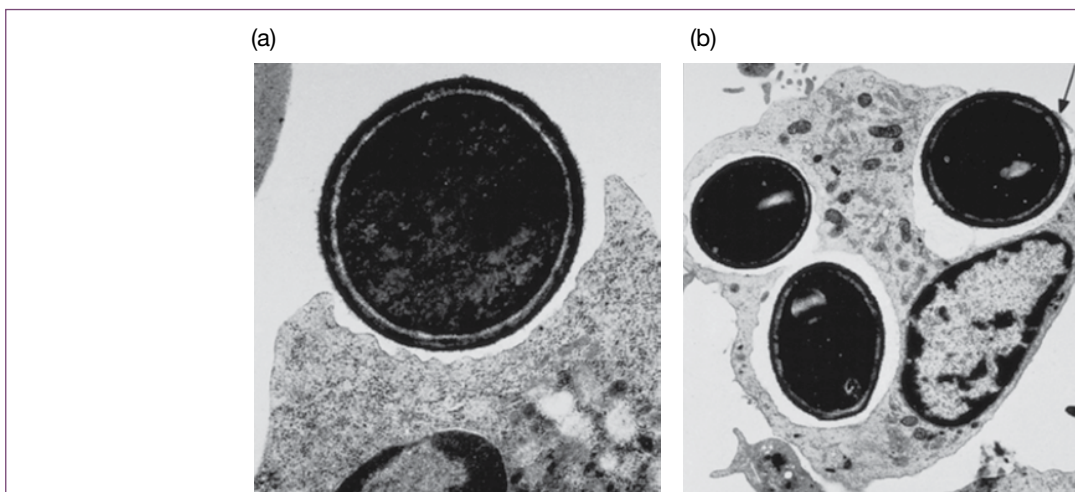


Figure 1.27 Adherence and phagocytosis. (a) Phagocytosis of *Candida albicans* by a polymorphonuclear leukocyte (neutrophil). Adherence to the yeast wall surface mannan initiates enclosure of the fungal particle within arms of cytoplasm. Lysosomal granules are abundant but mitochondria are rare ($\times 15\ 000$). (b) Phagocytosis of *C. albicans* by a monocyte showing near completion of phagosome formation (arrowed) around one organism and complete ingestion of two others ($\times 5000$). (Source: Dr. H. Valdimarsson. Reproduced with permission.)

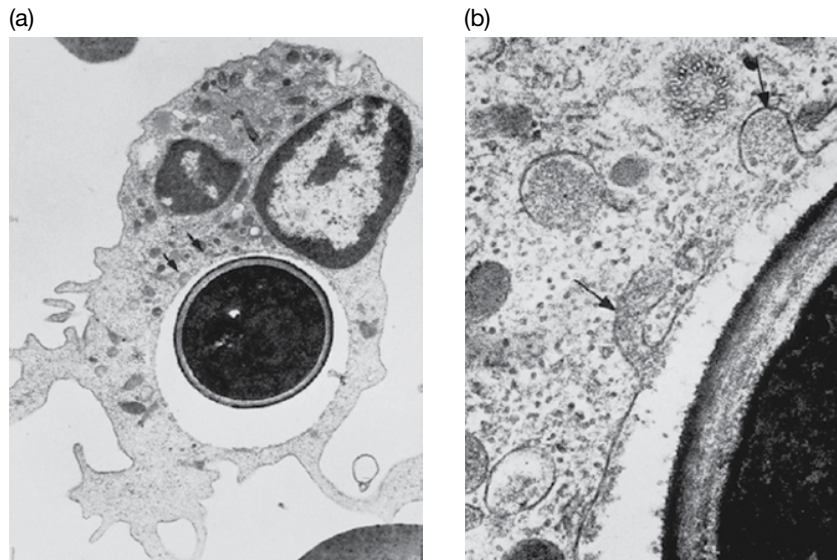
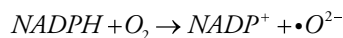


Figure 1.28 Phagolysosome formation. (a) Neutrophil 30 minutes after ingestion of *C. albicans*. The cytoplasm is already partly degranulated and two lysosomal granules (arrowed) are fusing with the phagocytic vacuole. Two lobes of the nucleus are evident ($\times 5000$). (b) Higher magnification of (a) showing fusing granules discharging their contents into the phagocytic vacuole (arrowed) ($\times 33\,000$). (Source: Dr. H. Valdimarsson. Reproduced with permission.)

membrane flavoprotein and thence to a unique plasma membrane **cytochrome (cyt b558)**. This has the very low midpoint redox potential of -245 mV that allows it to reduce molecular oxygen directly to superoxide anion (Figure 1.29a). Thus the key reaction catalyzed by this NADPH oxidase, which initiates the formation of reactive oxygen intermediates (ROI), is:



The superoxide anion undergoes conversion to hydrogen peroxide under the influence of superoxide dismutase, and subsequently to hydroxyl radicals ($\cdot\text{OH}$). Each of these products has remarkable chemical reactivity with a wide range of molecular targets, making them formidable microbicidal agents; $\cdot\text{OH}$ in particular is one of the most reactive free radicals known. Furthermore, the combination of peroxide, myeloperoxidase, and halide ions constitutes a potent halogenating system capable of killing both bacteria and viruses (Figure 1.29a). Although H_2O_2 and the halogenated compounds are not as active as the free radicals, they are more stable and therefore diffuse further, making them toxic to microorganisms in the extracellular vicinity.

Killing by reactive nitrogen intermediates

Nitric oxide surfaced prominently as a physiologic mediator when it was shown to be identical with endothelium-derived relaxing factor. This has proved to be just one of its many roles (including the mediation of penile erection, would you believe it!), but of major interest in the present context is its formation by an inducible $\text{NO}\cdot$ synthase (iNOS) within most cells, but

particularly macrophages and human neutrophils, thereby generating a powerful antimicrobial system (Figure 1.29b). Whereas the NADPH oxidase is dedicated to the killing of extracellular organisms taken up by phagocytosis and cornered within the phagocytic vacuole, the $\text{NO}\cdot$ mechanism can operate against microbes that invade the cytosol; so, it is not surprising that the majority of nonphagocytic cells that may be infected by viruses and other parasites are endowed with an iNOS capability. The mechanism of action may be through degradation of the Fe-S prosthetic groups of certain electron transport enzymes, depletion of iron, and production of toxic $\cdot\text{ONOO}$ radicals. The *N-ramp* gene, linked with resistance to microbes such as bacille Calmette–Guérin (BCG), *Salmonella*, and *Leishmania* that can live within an intracellular habitat, is now known to express a protein forming a transmembrane channel that may be involved in transporting $\text{NO}\cdot$ across lysosome membranes.

Killing by preformed antimicrobials

These molecules, contained within the neutrophil granules, contact the ingested microorganism when fusion with the phagosome occurs (Figure 1.29c). The dismutation of superoxide consumes hydrogen ions and raises the pH of the vacuole gently, so allowing the family of cationic proteins and peptides to function optimally. The latter, known as **defensins**, are approximately 3.5–4 kDa and invariably rich in arginine, and reach incredibly high concentrations within the phagosome, of the order of 20–100 mg/mL. Like the bacterial colicins described above, they have an amphipathic structure that allows them to insert into microbial membranes to form

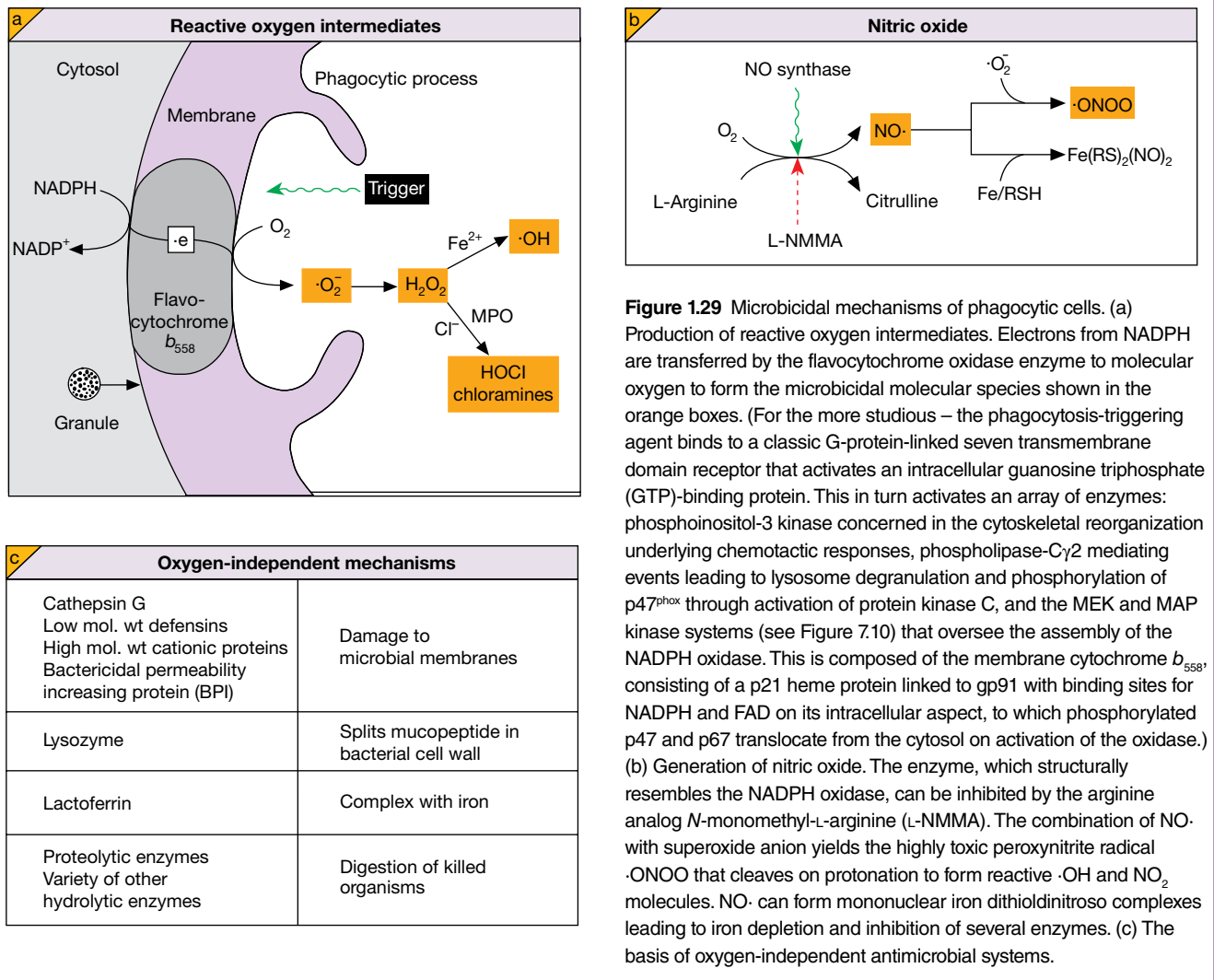


Figure 1.29 Microbicidal mechanisms of phagocytic cells. (a) Production of reactive oxygen intermediates. Electrons from NADPH are transferred by the flavocytochrome oxidase enzyme to molecular oxygen to form the microbicidal molecular species shown in the orange boxes. (For the more studious – the phagocytosis-triggering agent binds to a classic G-protein-linked seven transmembrane domain receptor that activates an intracellular guanosine triphosphate (GTP)-binding protein. This in turn activates an array of enzymes: phosphoinositol-3 kinase concerned in the cytoskeletal reorganization underlying chemotactic responses, phospholipase-C γ 2 mediating events leading to lysosome degranulation and phosphorylation of p47^{phox} through activation of protein kinase C, and the MEK and MAP kinase systems (see Figure 7.10) that oversee the assembly of the NADPH oxidase. This is composed of the membrane cytochrome b_{558} , consisting of a p21 heme protein linked to gp91 with binding sites for NADPH and FAD on its intracellular aspect, to which phosphorylated p47 and p67 translocate from the cytosol on activation of the oxidase.) (b) Generation of nitric oxide. The enzyme, which structurally resembles the NADPH oxidase, can be inhibited by the arginine analog *N*-monomethyl-L-arginine (L-NMMA). The combination of NO· with superoxide anion yields the highly toxic peroxynitrite radical ·ONOO that cleaves on protonation to form reactive ·OH and NO $_2$ molecules. NO· can form mononuclear iron dithiolodinitroso complexes leading to iron depletion and inhibition of several enzymes. (c) The basis of oxygen-independent antimicrobial systems.

destabilizing voltage-regulated ion channels (who copied whom?). These antibiotic peptides, at concentrations of 10–100 $\mu\text{g}/\text{mL}$, act as disinfectants against a wide spectrum of Gram-positive and Gram-negative bacteria, many fungi, and a number of enveloped viruses. Many exhibit remarkable selectivity for prokaryotic and eukaryotic microbes relative to host cells, partly dependent upon differential membrane lipid composition. One must be impressed by the ability of this surprisingly simple tool to discriminate large classes of nonself cells (i.e., microbes) from self.

As if this was not enough, further damage is inflicted on the bacterial membranes both by neutral protease (cathepsin G) action and by direct transfer to the microbial surface of BPI, which increases bacterial permeability. Low pH, lysozyme, and lactoferrin constitute bactericidal or bacteriostatic factors that are oxygen independent and can function under anaerobic circumstances. Interestingly, lysozyme and lactoferrin are synergistic in their action.

Finally, the killed organisms are digested by hydrolytic enzymes and the degradation products released to the exterior (Figure 1.26 h).

Neutrophils and macrophages can also deploy extracellular traps for microbes through releasing DNA

Recent discoveries have also revealed quite a surprising strategy that neutrophils (as well as their close granulocyte relatives) engage in for the purpose of immobilizing and killing extracellular bacteria and yeast: **the formation of NETs (neutrophil extracellular traps)**. It appears that activated neutrophils can activate a self-destruction pathway, the details of which are only emerging, that results in the release of the intracellular contents of the activated neutrophil into the extracellular space to act as a spider's web-like structure that can enmesh microbes and kill them *in situ* (Figure 1.30). The NETs themselves

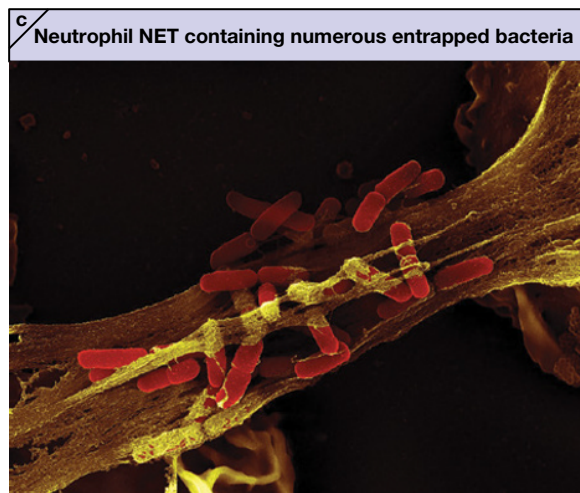
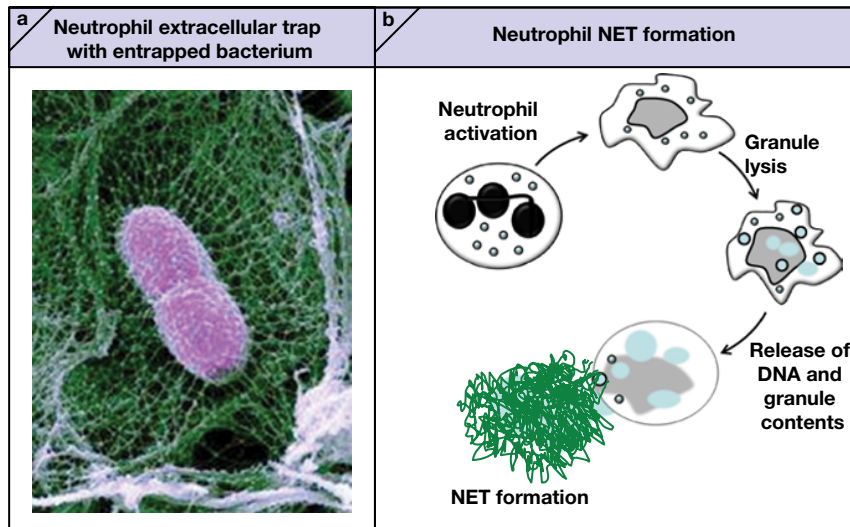


Figure 1.30 Neutrophil activation can lead to the formation of neutrophil extracellular traps (NETs). (a) A *Klebsiella* bacterium (purple) caught in a neutrophil NET (green). (b) Neutrophil NET formation occurs within 1–2 hours after neutrophil activation and involves the liberation of neutrophil DNA, histones, and granule enzymes into the extracellular space where they can ensnare bacteria, yeast, and other extracellular pathogens and kill them *in situ*. (c) Multiple bacteria (red) ensnared on a neutrophil NET. (Source: Images: Dr. Volker Brinkmann, Max Planck Institute for Infection Biology, Berlin, Germany.)

appear to be largely composed of neutrophil DNA with associated histones, along with high concentrations of neutrophil granule proteases such as cathepsin G, elastase, and proteinase-3. The NET is thought to act as a depot for the latter proteases, helping to restrain their off-target activities and also increase their local concentration. Interestingly, histone proteins have also been reported to have potent antimicrobial properties, although how this is achieved is unclear. Macrophages have also been reported to be able to deploy NET-like structures under certain circumstances. Does the immune system have no end to the strategies it will engage in to protect us from harm?

By now, the reader may be excused a little smugness as she or he shelters behind the impressive antimicrobial potential of the phagocytic cells. But there are snags to consider; our formidable array of weaponry is useless unless the phagocyte can: (i) “home onto” the microorganism; (ii) adhere to it; and (iii) respond by the membrane activation that initiates

engulfment. Some bacteria do produce chemical substances, such as the peptide formyl.Met.Leu.Phe, which directionally attract leukocytes, a process known as *chemotaxis*; many organisms do adhere to the phagocyte surface and many do spontaneously provide the appropriate membrane initiation signal. However, our teeming microbial adversaries are continually mutating to produce new species that may outwit the defenses by doing none of these. What then? The body has solved these problems with the effortless ease that comes with a few million years of evolution by developing the *complement* system.

Complement facilitates phagocytosis and bacterial lysis

The complement system comprises a group of some 20 or so plasma proteins that becomes activated in a cascade-like manner upon binding to certain microbial polysaccharides that are not normally present in vertebrates, but are commonly found

on bacterial membranes. Many of the complement factors are proteases that are initially produced as inactive precursors and become activated through the detection of PAMPs, with each protease activating the next in the chain. Complement activation can result in binding of complement to bacterial cell surfaces (called **opsonization** in immunological parlance), which can greatly enhance their uptake by phagocytes. Deposition of complement factors onto its surface can also result in **direct lysis** of a bacterium that has had the misfortune to trigger this cascade. Just as importantly, certain complement fragments that are produced as byproducts of complement activation can act as **chemotactic factors** to guide phagocytic cells (such as neutrophils and macrophages) to the hapless bacterium, resulting in its capture through phagocytosis. The latter complement factors can also **activate local mast cells** (as we mentioned earlier) to release molecules that help to recruit neutrophils and other cells of the immune system to the site of infection, through increasing the permeability of local blood vessels. Either way, complement activation spells trouble for our little bacterial foe. The many proteins involved can make the complement system appear daunting initially, but do keep in mind the overall objectives of enhancing phagocytosis, recruitment of other immune cells, and direct lysis of microorganisms, as we proceed through the details.

Complement and its activation

The complement cascade, along with blood clotting, fibrinolysis, and kinin formation, forms one of the triggered enzyme systems found in plasma. These systems characteristically produce a rapid, highly amplified response to a trigger stimulus mediated by a cascade phenomenon where the product of one reaction is the enzymic catalyst of the next.

Some of the complement components are designated by the letter “C” followed by a number that is related more to the

chronology of its discovery than to its position in the reaction sequence. The most abundant and the most pivotal component is C3, which has a molecular weight of 195 kDa and is present in plasma at a concentration of around 1.2 mg/mL.

C3 undergoes slow spontaneous cleavage

Under normal circumstances, an internal thiolester bond in C3 (Figure 1.31) becomes activated spontaneously at a very slow rate, either through reaction with water or with trace amounts of a plasma proteolytic enzyme, to form a reactive intermediate, either the split product C3b, or a functionally similar molecule designated C3i or C3(H₂O). In the presence of Mg²⁺ this can complex with another complement component, factor B, which then undergoes cleavage by a normal plasma enzyme (factor D) to generate C3bBb. Note that, conventionally, a bar over a complex denotes enzymic activity and that, on cleavage of a complement component, the larger product is generally given the suffix “b” and the smaller “a.”

C3bBb has an important new enzymic activity: it is a **C3 convertase** that can split C3 to give C3a and C3b. We will shortly discuss the important biological consequences of C3 cleavage in relation to microbial defenses, but under normal conditions there must be some mechanism to restrain this process to a “tick-over” level as it can also give rise to more C3bBb, that is, we are dealing with a potentially runaway **positive-feedback loop** (Figure 1.32). As with all potentially explosive triggered cascades, there are powerful regulatory mechanisms.

C3b levels are normally tightly controlled

In solution, the $\overline{\text{C3bBb}}$ convertase is unstable and factor B is readily displaced by another component, factor H, to form C3bH, which is susceptible to attack by the C3b inactivator,

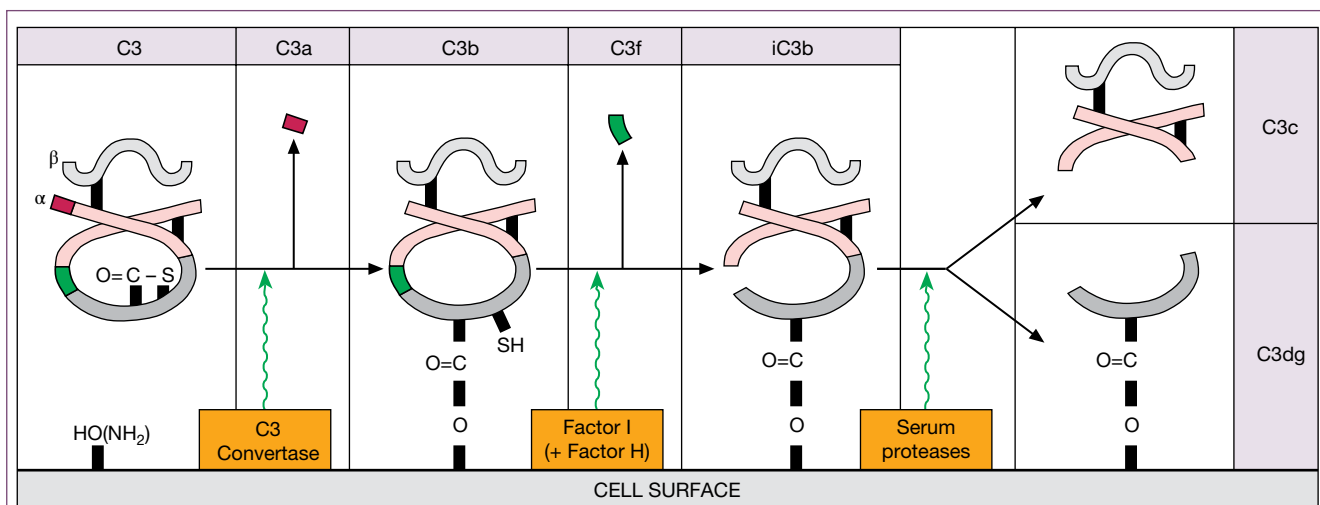


Figure 1.31 Structural basis for the cleavage of C3 by C3 convertase and its covalent binding to ·OH or ·NH₂ groups at the cell surface through exposure of the internal thiolester bonds. Further cleavage leaves the progressively smaller fragments, C3dg and C3d, attached to the membrane. (Adapted from Law S.H.A. and Reid K.B.M. (1988) *Complement*, figure 2.4. IRL Press, Oxford.)

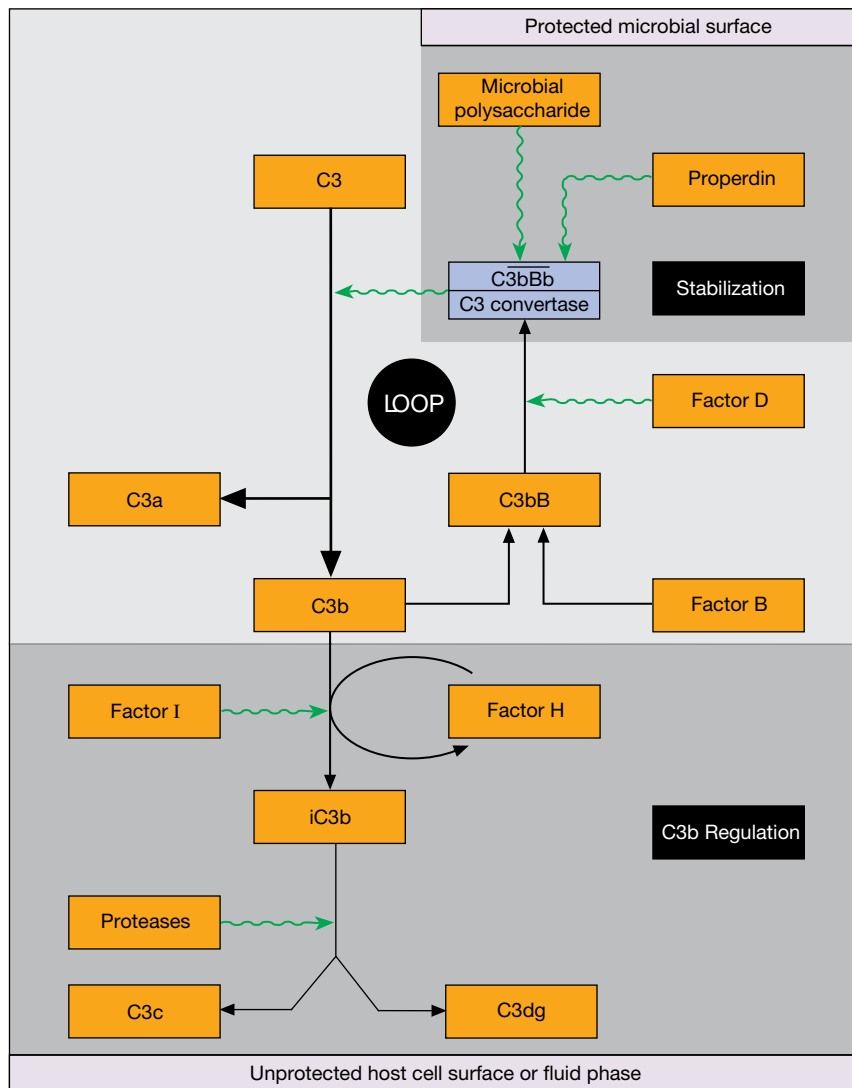


Figure 1.32 Microbial activation of the alternative complement pathway by stabilization of the C3 convertase ($\overline{C3bBb}$) and its control by factors H and I. When bound to the surface of a host cell or in the fluid phase, the C3b in the convertase is said to be “unprotected,” in that its affinity for factor H is much greater than for factor B and is therefore susceptible to breakdown by factors H and I. On a microbial surface, C3b binds factor B more strongly than factor H and is therefore “protected” from or “stabilized” against cleavage – even more so when subsequently bound by properdin. Although in phylogenetic terms this is the oldest complement pathway, it was discovered after a separate pathway to be discussed in the next chapter, and so has the confusing designation “alternative.” Green wiggly arrow represents an activation process. The horizontal bar above a component designates its activation.

factor I (Figure 1.32). The inactivated iC3b is biologically inactive and undergoes further degradation by proteases in the body fluids. Other regulatory mechanisms are discussed later.

C3 convertase is stabilized on microbial surfaces

A number of microorganisms can activate the $\overline{C3bBb}$ convertase to generate large amounts of C3 cleavage products **by stabilizing the enzyme on their (carbohydrate) surfaces**, thereby protecting the C3b from factor H. Another protein, properdin, acts subsequently on this bound convertase to stabilize it even further. As C3 is split by the surface membrane-

bound enzyme to nascent C3b, it undergoes conformational change and its potentially reactive internal thiolester bond becomes exposed. As the half-life of nascent C3b is less than 100 microseconds, it can only diffuse a short distance before reacting covalently with local hydroxyl or amino groups available at the microbial cell surface (Figure 1.31). Each catalytic site thereby leads to the clustering of large numbers of C3b molecules on the microorganism. This series of reactions leading to C3 breakdown provoked directly by microbes has been called **the alternative pathway** of complement activation (Figure 1.32).

The post-C3 pathway generates a membrane attack complex

Recruitment of a further C3b molecule into the $\overline{\text{C3bBb}}$ enzymic complex generates a C5 convertase that activates C5 by proteolytic cleavage, releasing a small polypeptide, C5a, and

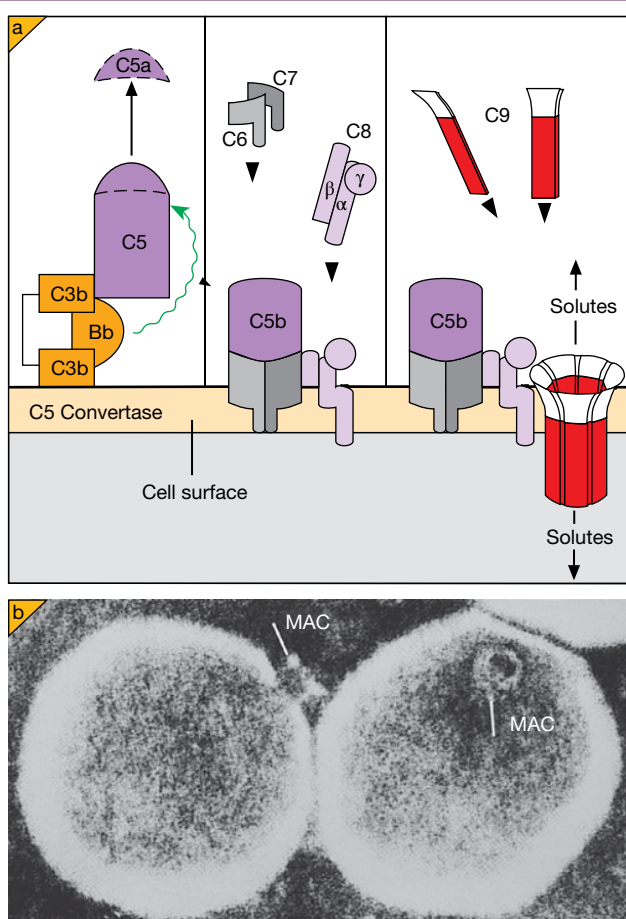


Figure 1.33 Post-C3 pathway generating C5a and the C5b-9 membrane attack complex (MAC). (a) Cartoon of molecular assembly. The conformational change in C9 protein structure that converts it from a hydrophilic to an amphipathic molecule (bearing both hydrophobic and hydrophilic regions) can be interrupted by an antibody raised against linear peptides derived from C9; as the antibody does not react with the soluble or membrane-bound forms of the molecule, it must be detecting an intermediate structure transiently revealed in a deep-seated structural rearrangement. (b) Electron micrograph of a membrane C5b-9 complex incorporated into liposomal membranes clearly showing the annular structure. The cylindrical complex is seen from the side inserted into the membrane of the liposome on the left, and end-on in that on the right. Although in itself a rather splendid structure, formation of the annular C9 cylinder is probably not essential for cytotoxic perturbation of the target cell membrane, as this can be achieved by insertion of amphipathic C9 molecules in numbers too few to form a clearly defined MAC. (Source: Professor J. Tranum-Jensen and Dr. S. Bhakdi. Reproduced with permission.)

leaving the large C5b fragment loosely bound to C3b. Sequential attachment of C6 and C7 to C5b forms a complex with a transient membrane-binding site and an affinity for the β -peptide chain of C8. The C8 α chain sits in the membrane and directs the conformational changes in C9 that transform it into an amphipathic molecule capable of insertion into the lipid bilayer (cf. the colicins) and polymerization to an annular **membrane attack complex** (MAC; Figure 1.33). This forms a transmembrane channel fully permeable to electrolytes and water, and because of the high internal colloid osmotic pressure of cells, there is a net influx of Na⁺ and water, frequently leading to lysis.

Complement has a range of defensive biological functions

These can be grouped conveniently under three headings:

- 1. C3b adheres to complement receptors:** Phagocytic cells have receptors for C3b (CR1) and iC3b (CR3) that facilitate the adherence of C3b-coated microorganisms to the cell surface (discussed more fully in Chapter 11).
- 2. Biologically active fragments are released:** C3a and C5a, the small peptides split from the parent molecules during complement activation, have several important actions. Both act directly on phagocytes, especially neutrophils, to stimulate the respiratory burst associated with the production of reactive oxygen intermediates and to enhance the expression of surface receptors for C3b and iC3b. Also, both are **anaphylatoxins** in that they are capable of triggering mediator release from mast cells (Figure 1.14 and Figure 1.34) and their circulating counterpart, the basophil (Figure 1.9), a phenomenon of such relevance to our present discussion that we have presented details of the mediators and their actions in Figure 1.14; note in particular the chemotactic properties of these mediators and their effects on blood vessels. In its own right, C3a is a chemoattractant for eosinophils whereas C5a is a potent neutrophil chemotactic agent and also has a striking ability to act directly on the capillary endothelium to produce vasodilatation and increased permeability, an effect that seems to be prolonged by leukotriene B₄ released from activated mast cells, neutrophils and macrophages.
- 3. The terminal complex can induce membrane lesions:** As described above, the insertion of the MAC into a membrane may bring about cell lysis. Providentially, complement is relatively inefficient at lysing the cell membranes of the autologous host owing to the presence of control proteins.

We can now put together an effectively orchestrated defensive scenario initiated by activation of the alternative complement pathway.

In the first act, C3bBb is stabilized on the surface of the microbe and cleaves large amounts of C3. The C3a fragment is released but C3b molecules bind copiously to the microbe.

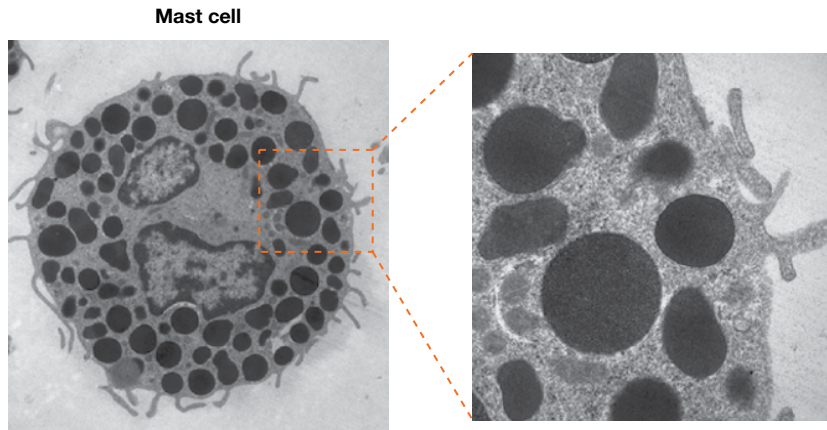


Figure 1.34 The mast cell. Transmission electron micrograph of a resting mouse peritoneal mast cell illustrating the copious membrane-enclosed granules that are filled with inflammatory mediators. Release of the latter mediators may be triggered by direct injury, complement products (C3a, C5a), and through direct stimulation with PAMPs. (Source: Source: Gunnar Pejler, University of Uppsala, Sweden. Reproduced with permission.)

These activate the next step in the sequence to generate C5a and the membrane attack complex (although many organisms will be resistant to its action).

Humoral mechanisms provide an additional defensive strategy

Microbicidal factors in secretions

Turning now to those defense systems that are mediated entirely by *soluble pattern recognition molecules* (Figure 1.2), we recollect that many microbes activate the complement system and may be lysed by the insertion of the membrane attack complex. The spread of infection may be limited by enzymes released through tissue injury that activate the clotting system. Of the soluble bactericidal substances elaborated by the body, perhaps the most abundant and widespread is the enzyme lysozyme, a muramidase that splits the exposed peptidoglycan wall of susceptible bacteria (see Figure 11.5).

Like the α -defensins of the neutrophil granules, the human β -defensins are peptides derived by proteolytic cleavage from larger precursors; they have β -sheet structures, 29–40 amino acids, and three intramolecular disulfide bonds, although they differ from the α -defensins in the placement of their six cysteines. The main human β -defensin, hDB-1, is produced abundantly in the kidney, the female reproductive tract, the oral gingiva, and especially the lung airways. As the word has it that we are all infected every day by tens of thousands of airborne bacteria, this must be an important defense mechanism. This being so, inhibition of hDB-1 and of a second pulmonary defensin, hDB-2, by high ionic strength could account for the susceptibility of cystic fibrosis patients to infection as they have an ion channel mutation that results in an elevated chloride concentration in airway surface fluids. Another airway antimicrobial active

against Gram-negative and Gram-positive bacteria is LL-37, a 37-residue α -helical peptide released by proteolysis of a cathelicidin (cathepsin L-inhibitor) precursor.

This theme surfaces again in the stomach where a peptide split from lactoferrin by pepsin could provide the gastric and intestinal secretions with some antimicrobial policing. A rather longer two-domain peptide with 107 residues, termed secretory leukocyte protease inhibitor (SLPI), is found in many human secretions. The C-terminal domain is anti-protease but the N-terminal domain is distinctly unpleasant to metabolically active fungal cells and to various skin-associated microorganisms, which makes its production by human keratinocytes particularly appropriate. In passing, it is worth pointing out that many D-amino acid analogs of peptide antibiotics form left-handed helices that retain the ability to induce membrane ion channels and hence their antimicrobial powers and, given their resistance to catabolism within the body, should be attractive candidates for a new breed of synthetic antibiotics.

Lastly, we may mention the two lung surfactant proteins SP-A and SP-D that, in conjunction with various lipids, lower the surface tension of the epithelial lining cells of the lung to keep the airways patent. They belong to a totally different structural group of molecules termed collectins (Figure 1.35) that contribute to innate immunity through binding of their lectin-like domains to carbohydrates on microbes, and their collagenous stem to cognate receptors on phagocytic cells – thereby facilitating the ingestion and killing of the infectious agents.

Acute phase proteins increase in response to infection

A number of plasma proteins collectively termed acute phase proteins show a dramatic increase in concentration in response to early “alarm” mediators such as macrophage-derived

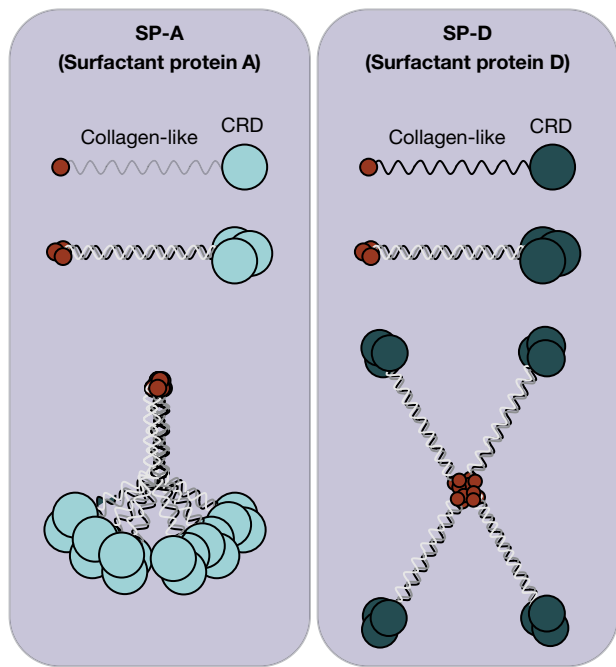


Figure 1.35 Structural features of surfactant proteins A and D. Surfactant proteins are composed of collagen-like and carbohydrate recognition domains (CRD) that are arranged into trimers (middle) and further arranged into higher order multimers of trimers (bottom). Surfactants belong to the collectin family and can recognize nonself carbohydrate moieties on microbes, leading to opsonization followed by phagocytosis.

interleukin-1 (IL-1) released as a result of infection or tissue injury. These include C-reactive protein (CRP), mannose-binding lectin (MBL), and serum amyloid P component (Table 1.2). Expression levels of the latter proteins can increase by as much as 1000-fold in response to proinflammatory cytokines such as IL-1 and IL-6. Other acute phase proteins showing a more modest rise in concentration include α_1 -antichymotrypsin, fibrinogen, ceruloplasmin, C9, and factor B.

The acute phase proteins are a relatively diverse group of proteins belonging to several different families (including, but not limited to, the *pentraxin*, *collectin*, and *ficolin* families) that have a number of functional effects in common. All of these proteins act as soluble pattern recognition molecules and are capable of binding directly to infectious agents to function as opsonins (i.e., “made ready for the table”), thereby enhancing uptake of microorganisms by macrophages and neutrophils. Many of these proteins also have the ability to activate complement and the assembly of a membrane attack complex. The ability to agglutinate microorganisms, thereby impeding their spread within the infected tissue, is another common theme. Some of these molecules can also form heterocomplexes, extending the range of PAMPs that can be detected.

These soluble pattern recognition molecules are frequently synthesized by activated macrophages upon stimulation of

Table 1.2 Acute phase proteins.

Acute phase reactant	Role
Dramatic increases in concentration	
C-reactive protein	Fixes complement, opsonizes
Mannose binding lectin	Fixes complement, opsonizes
α_1 -Acid glycoprotein	Transport protein
Serum amyloid P component	Amyloid component precursor
Moderate increases in concentration	
α_1 -Protease inhibitors	Inhibit bacterial proteases
α_1 -Antichymotrypsin	Inhibit bacterial proteases
C3, C9, factor B	Increase complement function
Ceruloplasmin	$\cdot\text{O}_2^-$ scavenger
Fibrinogen	Coagulation
Angiotensin	Blood pressure
Haptoglobin	Bind hemoglobin
Fibronectin	Cell attachment

their pattern recognition receptors, or are stored within neutrophil granules available for immediate release via degranulation in response to infection. The liver is another major source of many acute phase proteins that are released into the circulation as a result of the systemic effects of the major proinflammatory cytokines IL-1 and IL-6. Let us look at some examples further.

Pentraxins

Pentraxins, so-called because these agents are made up of five identical subunits, constitute a superfamily of conserved proteins typified by a cyclic multimeric structure and a C-terminal 200-amino-acid-long pentraxin domain. CRP, serum amyloid P component (SAP), and pentraxin 3 are members of this family (Figure 1.36). Human CRP is composed of five identical polypeptide units noncovalently arranged as a cyclic pentamer around a calcium (Ca)-binding cavity, was the first pentraxin to be described, and is the prototypic acute phase response protein. Pentraxins have been around in the animal kingdom for some time, as a closely related homolog, limulin, is present in the hemolymph of the horseshoe crab, not exactly a close relative of *Homo sapiens*. A major property of CRP is its ability to bind in a Ca-dependent fashion, as a pattern recognition molecule, to a number of microorganisms that contain phosphorylcholine in their membranes, the complex having the useful property of activating complement (by the classical and not the alternative pathway with which we are at present familiar). This results in the deposition of C3b on the surface of the microbe that thus becomes opsonized for adherence to phagocytes.

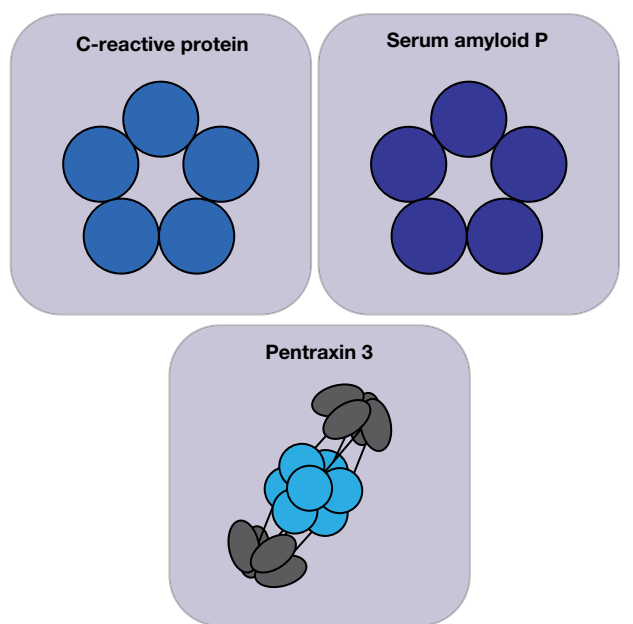


Figure 1.36 Higher order features of pentraxins. Pentraxins, such as C-reactive protein (CRP), serum amyloid P (SAP) and pentraxin 3, as depicted, are all composed of five identical subunits with a cyclic structure. Pentraxins act as soluble PRRs and can opsonize bacteria as well as promote complement activation.

SAP can complex with chondroitin sulfate, a cell matrix glycosaminoglycan, and subsequently bind lysosomal enzymes such as cathepsin B released within a focus of inflammation. The degraded SAP becomes a component of the amyloid fibrillar deposits that accompany chronic infections – it might even be a key initiator of amyloid deposition. SAP also binds several bacterial species via LPS and, similar to CRP, can also activate the classical complement pathway. CRP and SAP represent the main acute phase reactants in human and mouse, respectively.

Collectins

Nine members of the collectin family have been described in vertebrates to date, the most intensively studied of which is *mannose-binding lectin (MBL)*. MBL can react not only with mannose but several other sugars, so enabling it to bind with an exceptionally wide variety of Gram-negative and Gram-positive bacteria, yeasts, viruses, and parasites; its subsequent ability to trigger the classical C3 convertase through two novel associated serine proteases (MASP-1 and MASP-2) is the basis of what is known as the *lectin pathway* of complement activation. (Please relax, we unravel the secrets of the classical and lectin pathways in the next chapter.)

MBL is a multiple of trimeric complexes, each unit of which contains a collagen-like region joined to a globular lectin-binding domain (Figure 1.37). This structure places it in the family of collectins (*collagen + lectin*) that have the ability

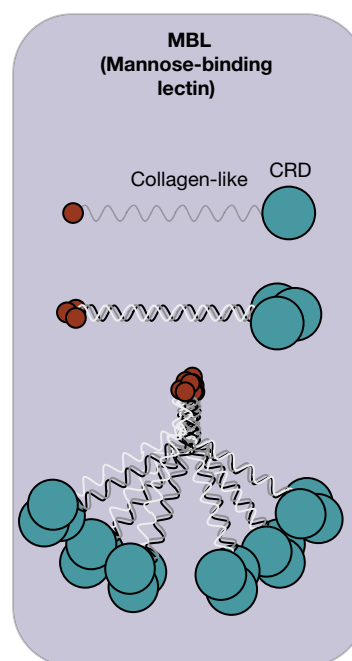


Figure 1.37 Structural features of mannose-binding lectin. Mannose-binding lectin (MBL) is a multiple of trimeric complexes, each unit of which contains a collagen-like and lectin-binding domain (or carbohydrate recognition domain, CRD). MBL can react with a wide variety of bacterial carbohydrates, such as mannose, leading to opsonization of bacteria for uptake through phagocytosis, or can activate the lectin pathway to complement activation (which will be discussed in detail in Chapter 2) through the actions of two associated serine proteases (MASP-1 and MASP-2).

to recognize “foreign” carbohydrate patterns differing from “self” surface polysaccharides, normally terminal galactose and sialic acid groups, whereas the collagen region can bind to and activate phagocytic cells through complementary receptors on their surface. The collectins, especially MBL and the alveolar surfactant molecules SP-A and SP-D mentioned earlier (Figure 1.35), have many attributes that qualify them for a first-line role in innate immunity as soluble PRRs. These include the ability to differentiate self from nonself, to bind to a variety of microbes, to generate secondary effector mechanisms, and to be widely distributed throughout the body including mucosal secretions. They are of course the soluble counterparts to the cell surface C-type lectin PRRs described earlier.

Interest in the collectin conglutinin has intensified with the demonstration, first, that it is found in humans and not just in cows, and second, that it can bind to *N*-acetylglucosamine; being polyvalent, this implies an ability to coat bacteria with C3b by cross-linking the available sugar residue in the complement fragment with the bacterial proteoglycan. Although it is not clear whether conglutinin is a member of the acute phase protein family, we mention it here because it embellishes the

general idea that the evolution of lectin-like molecules that bind to microbial rather than self polysaccharides, and which can then hitch themselves to the complement system or to phagocytic cells, has proved to be such a useful form of protection for the host.



Ficolins

These proteins are structurally and functionally related to collectins (Figure 1.38), and can also recognize carbohydrate-based PAMPs on microorganisms to activate the lectin pathway of complement activation. Ficolins typically recognize *N*-acetylglucosamine residues in complex-type carbohydrates in addition to other ligands. Three ficolins have been identified in humans, ficolin-1, -2, and -3 (also known as M-, L-, and H-ficolin, respectively), and a role as opsonins for the enhancement of phagocytosis has also been demonstrated for these proteins. Ficolins can also interact with CRP to widen the range of bacteria recognized by the latter and also to enhance complement-mediated killing. The range of bacterial structures recognized by ficolins and MBL are complementary and recognize different but overlapping bacterial species.

Interferons inhibit viral replication

Recall from our earlier discussion of pattern recognition receptors (PRRs) that engagement of many of these receptors by PAMPs results in the production of cytokines and chemokines

that act to amplify immune responses by binding to cells in the vicinity. An important class of cytokines induced by viral as well as bacterial infection is the type I **interferons** (IFN α and IFN β). These are a family of broad-spectrum antiviral agents present in birds, reptiles, and fish as well as the higher animals, and first recognized by the phenomenon of viral interference in which an animal infected with one virus resists superinfection by a second unrelated virus. Different molecular forms of interferon have been identified, the genes for all of which have been isolated. There are at least 14 different α -interferons (IFN α) produced by leukocytes, while fibroblasts, and probably all cell types, synthesize IFN β . We will keep a third type (IFN γ), which is not directly induced by viruses, up our sleeves for the moment.

Cells synthesize interferon when infected by a virus and secrete it into the extracellular fluid, where it binds to specific receptors on uninfected neighboring cells. As we saw earlier, engagement of several members of the TLR family, as well as the RIG-like helicase receptors and the cytoplasmic DNA sensors, with their cognate PAMPs results in the induction of members of the interferon-regulated factor (IRF) family of transcription factors (Figure 1.22 and Figure 1.23). In combination with NF κ B, another transcription factor activated by engagement of several of the PRRs, IRFs induce expression of type I interferons that are secreted and bind to cells in the vicinity. Long double-stranded RNA molecules, which are produced during the life cycle of most viruses, are particularly good inducers of interferons. The bound interferon now exerts its antiviral effect in the following way. At least two genes are thought to be derepressed in the interferon-binding cell, allowing the synthesis of two new enzymes. The first, a protein kinase called **protein kinase R** (PKR), catalyzes the phosphorylation of a ribosomal protein and an initiation factor (eIF-2) necessary for protein synthesis. The net effect of this is to dramatically reduce protein translation as a means of reducing the efficiency of virus production. Another gene product induced by interferons, **oligoadenylate synthetase**, catalyzes the formation of a short polymer of adenylic acid which activates a latent endoribonuclease; this in turn degrades both viral and host mRNA. This is another clever adaptation that is designed to reduce the production of viral products. Another consequence of the downturn in protein synthesis is a reduction in the expression of major histocompatibility complex (MHC) proteins, making cells susceptible to the effects of **natural killer** cells.

The net result is to establish a cordon of uninfected cells around the site of virus infection, so restraining its spread. The effectiveness of interferon *in vivo* may be inferred from experiments in which mice injected with an antiserum to murine interferons could be killed by several hundred times less virus than was needed to kill the controls. However, it must be presumed that interferon plays a significant role in the recovery from, as distinct from the prevention of, viral infections.

As a group, the interferons may prove to have a wider biological role than the control of viral infection. It will be clear,

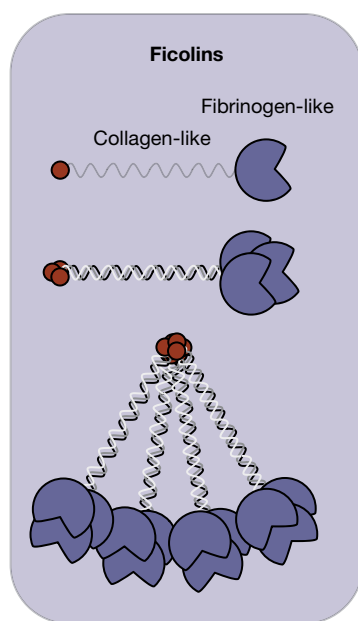


Figure 1.38 Structural features of ficolins. Ficolins are composed of collagen-like and fibrinogen-like domains (top), that are further arranged into trimers (middle), and then multimerize into higher order structures (bottom). Ficolins can bind to carbohydrate-based PAMPs to activate the lectin pathway to complement activation, or can opsonize bacteria for uptake through phagocytosis.

for example, that the induced enzymes described above would act to inhibit host cell division just as effectively as viral replication.

Natural killer cells kill virally infected cells

Thus far, we have dealt with situations that deal primarily with infectious agents that reside in the extracellular space. But what if an infectious agent manages to enter cells of the host, where they are protected from the attentions of the soluble PRRs (e.g., complement) and are also shielded from phagocytosis by macrophages and neutrophils? To deal with this situation, another type of immune cell has evolved – the natural killer (NK) cell, which is endowed with the ability to inspect host cells for signs of abnormal patterns of protein expression that may indicate that such cells might be harboring a virus. NK cells are also capable of killing cells that have suffered mutations and are on the way to malignant transformation into tumors. Note that although NK cells constitute a component of the innate response, under certain circumstances they exhibit immunological memory, a feature usually confined to adaptive responses.

Natural killer (NK) cells kill host cells that appear abnormal

NK cells are large granular leukocytes with a characteristic morphology. They choose their victims on the basis of two major criteria. The first, termed “*missing self*,” relates to the fact that practically all nucleated cells in the body express molecules on their surface called *major histocompatibility complex (MHC)* proteins. The latter molecules have a very important role in activating cells of the adaptive immune system, which we will deal with later in this chapter, but for now, it is sufficient to know that a cell lacking MHC molecules is not a good proposition from the perspective of the immune system. NK cells exist as a countermeasure to such an eventuality and cells lacking the normal pattern of expression of MHC molecules are swiftly recognized and killed by NK cells. As we saw in the previous section dealing with interferons, one way in which the expression of MHC molecules can be reduced is as a consequence of interferon-responsive gene products that can interfere with protein translation within cells infected by viruses, or in the vicinity of such cells.

In addition to reduced or absent MHC expression, NK cells are also capable of inspecting cells for the expression of MHC-related molecules (called nonclassical MHC molecules) and other proteins that are not normally expressed on cells, but become so in response to certain stresses such as DNA damage. This scenario represents “*altered self*” and also results in such cells being singled out for the attentions of NK cells, culminating in swift execution. NK receptors have also been found to be capable of detecting certain viral proteins directly, such as hemagglutinin from the influenza virus, that qualifies such receptors as another class of PRRs. There are additional receptors on the surfaces of NK cells that enable

these cells to recognize infected or transformed cells that we will discuss in Chapter 4. Clearly an NK is not a cell to get on the wrong side of.

NK cells kill target cells via two different pathways

Upon recognition of a target cell, through either of the mechanisms mentioned in the preceding section, the NK cell has two main weapons at its disposal, either of which is sufficient to kill a target cell within a matter of 30–60 minutes (see Videoclip 3). In both cases the target cell dies through switching on its own cell death machinery as a result of encounter with the NK cell; thus, NK killing represents a type of assisted cellular suicide. During NK-mediated killing, killer and target are brought into close apposition (Figure 1.39) as a result of detection of either missing self or altered self on the target cell. This can engage either the *death receptor pathway* or the *granule-dependent pathway* to apoptosis (Figure 1.40). We shall consider these in turn, although the outcomes are very similar.

Death receptor-dependent cell killing

Death receptors are a subset of the TNF receptor superfamily, which includes the receptors for Fas, TNF, and TRAIL, and these molecules derive their name from the observation that ligation of such receptors with the appropriate ligand can result in death of the cell bearing the receptor (Figure 1.40). When this observation was first made, it was a fairly astonishing proposition as it suggested that a cell could be killed through the simple expedient of tickling a membrane receptor in the correct way. Clearly, this is a very different type of killing compared with that seen upon exposure of a cell to a toxic chemical or physical stress that can kill through disruption of normal cellular processes. Here we have a physiological receptor/ligand system that exists for the purpose of killing cells on demand – something it has to be said that the immune system does a lot of. Naturally, this sparked a lot of investigation directed towards understanding how ligation of Fas, TNF, and related receptors culminates in cell death and this is now understood in fine detail as a consequence. Engagement of Fas or TNF receptors with their trimeric ligands results in the recruitment of a protease, called *caspase-8*, to the receptor complex that becomes activated as a result of receptor-induced aggregation of this protease that now undergoes autoactivation (Figure 1.41). Activation of caspase-8 at the receptor then results in propagation of the signaling cascade in two possible ways, either via proteolysis of Bid, which routes the signal through mitochondria, or by direct processing of other *effector caspases* (caspases-3 and -7) downstream. In each case, activation of the effector caspases culminates in death of the cell via apoptosis, which, as we mentioned earlier in this chapter, represents a programmed mode of cell death. NK cells can kill target cells in a Fas ligand-dependent manner, but can also kill through the related TNF ligand to some extent.



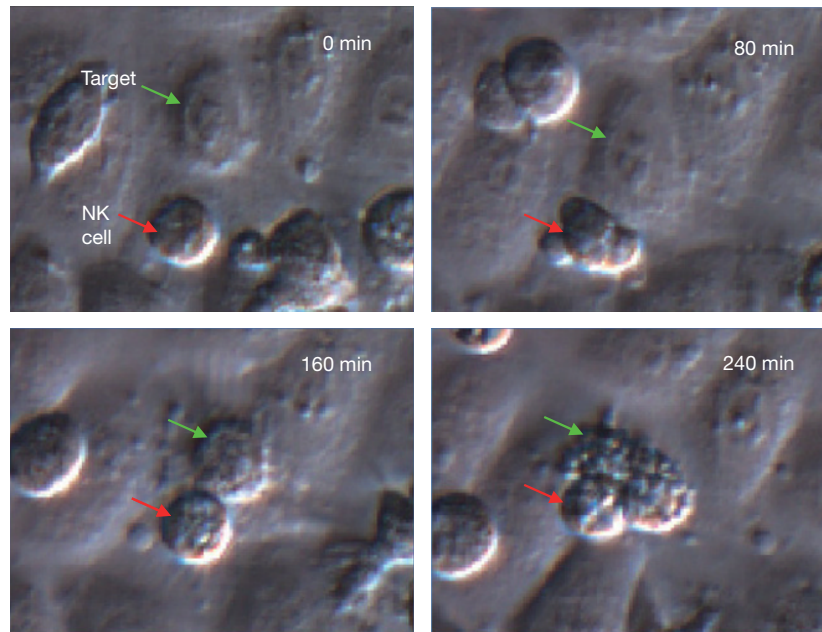


Figure 1.39 Cytotoxic lymphocyte killing. In this time-lapse series, an NK cell (red arrows) is observed to come into close contact with a target cell (green arrows), which is rapidly followed by rounding up and vigorous membrane blebbing within the target cell as it undergoes apoptosis. The interval between each frame is 80 minutes. (Source: Dr. Sean Cullen, Martin Laboratory, Trinity College Dublin, Ireland. Reproduced with permission.)

Granule-dependent cell killing

NK cells also possess cytotoxic granules that contain a battery of serine proteases, called *granzymes*, as well as a pore-forming protein called *perforin*. Activation of the NK cell leads to polarization of granules between nucleus and target within minutes, and extracellular release of their contents into the space between the two cells followed by target cell death. Polarization of the granules towards the target cell takes place as a result of the formation of a synapse between the killer and target that is composed of an adhesion molecule called LFA-1 and its cognate receptor ICAM-1.

Perforin bears some structural homology to C9; it is like that protein, but without any help other than from Ca^{2+} it can insert itself into the membrane of the target, apparently by binding to phosphocholine through its central amphipathic domain. It then polymerizes to form a transmembrane pore with an annular structure, comparable to the complement membrane attack complex (Figure 1.41). This pore then facilitates entry of the additional cytotoxic granule constituents, the granzymes, which do the actual killing. Perforin-deficient animals are severely compromised in terms of their ability to kill target cells, as the granule-dependent pathway no longer functions in the absence of a mechanism to deliver the granzymes into the target.

Granzymes kill through proteolysis of a variety of proteins within the target cell. Most of the killing potential resides in granzymes A and B, with the function of several additional granzymes (H, K, and M in humans) still unclear. The mode of

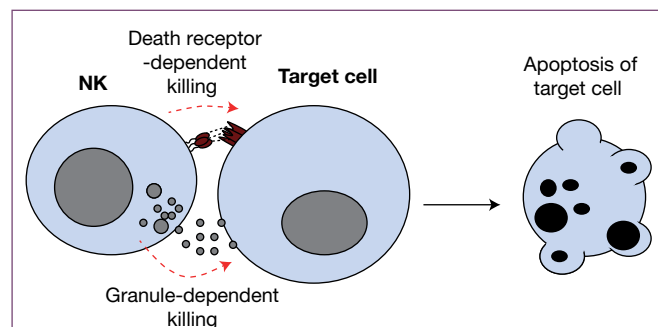


Figure 1.40 Natural killer (NK) cells can kill target cells by two major mechanisms: the death receptor and granule-dependent pathways. In both cases, the target cell dies as a result of the activation of a battery of cytotoxic proteases within the target cell, called caspases. See Figure 1.41 for further details of the molecular mechanisms of killing in either case.

action of *granzyme B* is particularly well understood and it has been found that this protease in essence mimicks the action of caspase-8 in the death receptor pathway to apoptosis, as described above. Thus, upon entry into the target cell, granzyme B can initiate apoptosis by cleaving Bid or through directly processing and activating the downstream effector caspases (Figure 1.41). Both routes result in the activation of the effector caspases that coordinate the dismantling of the cell through restricted proteolysis of hundreds of key cellular proteins.

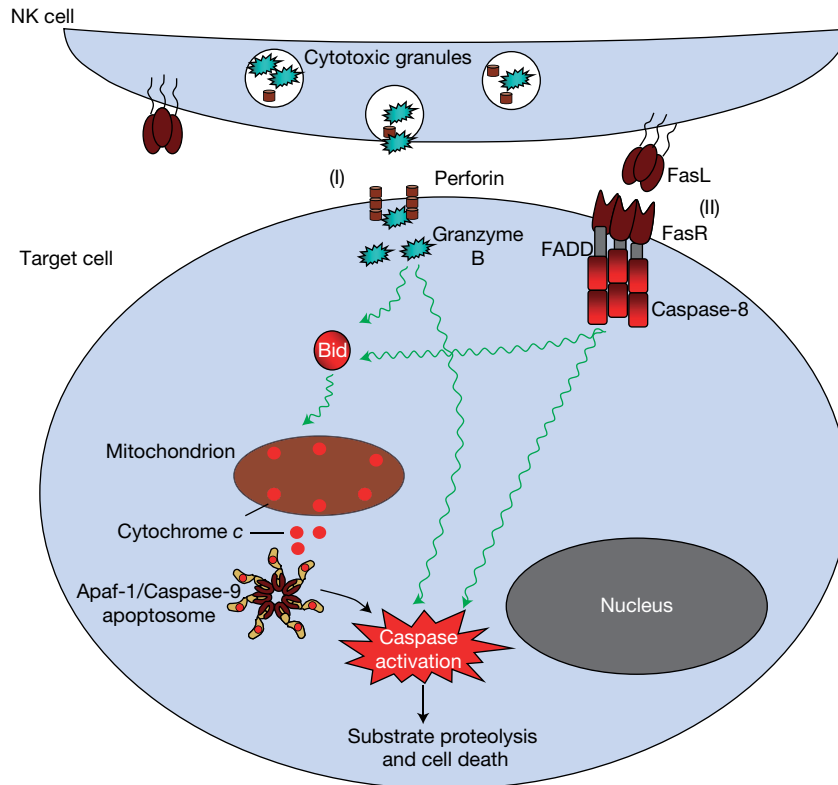


Figure 1.41 Signal transduction events involved in natural killer (NK) cell-mediated apoptosis. NK cells can kill target cells by two major pathways (I) or (II) as shown. In the cytotoxic granule-dependent pathway (I), binding of the NK receptors to the surface of the virally infected cell triggers the extracellular release of perforin (a pore-forming protein) and granzymes (which are a diverse collection of proteases) from the NK cell cytotoxic granules; perforin polymerizes within the target cell membrane to form transmembrane channels that permit entry of granzymes into the target cell. Granzymes induce apoptotic cell death through activation of the caspase protease cascade, either by directly processing and activating caspases, or through release of cytochrome *c* from mitochondria that activates the “apoptosome” pathway to caspase activation. In the second pathway (II) to cell death (called the death receptor pathway), membrane-bound Fas ligand (FasL) on the NK cell engages and trimerizes surface Fas receptors on the target cell. Engagement of Fas receptors recruits the adaptor protein FADD, followed by caspase-8, which then becomes activated at the receptor. Caspase-8 can then promote further caspase activation through directly processing other caspases, or via the mitochondrial apoptosome pathway similar to granzymes. In both pathways, the final common pathway to apoptosis occurs as a result of the activation of several “executioner caspases” that coordinate cell death through restricted proteolysis of hundreds of cellular proteins.

NK cell activity can be enhanced by PAMPs as well as type I interferons

NK cells also express a subset of the TLRs that are focused towards detecting PAMPs, such as double-stranded RNA, that are typically associated with viruses. TLR3, TLR7, and TLR8 all appear to be functional in NK cells and upon engagement of these receptors, NK cells become activated and their killing potential is enhanced. *Interferon- α* and *interferon- β* are also important activators of NK cells, the effects of which can increase the killing activity of such cells by up to 100-fold (Figure 1.42). Recall from our earlier discussion of PRRs, especially those that detect intracellular infections such as the cytoplasmic DNA sensor, STING, and the viral RNA sensors within RIG-I-like receptor family (Figure 1.22 and Figure 1.23), that activation of these PRRs induces the

expression of Type I interferons, such as IFN- α and IFN- β . This is an excellent example of cooperation between cells of the innate immune system, where cytokines produced by macrophages or other cells upon detection of a pathogen results in the activation of other cells, NK cells in the present context, that may be better adapted to dealing with the infectious threat.

Activated NK cells can amplify immune responses through production of IFN γ

Another consequence of the activation of NK cells is the production of another type of interferon, IFN γ , a very important cytokine that has a set of activities distinct from that of IFN α and IFN β . Macrophages respond to IFN γ by greatly enhancing their microbicidal activities and also by producing other cytokines (such as IL-12) that shape the nature of the ensuing

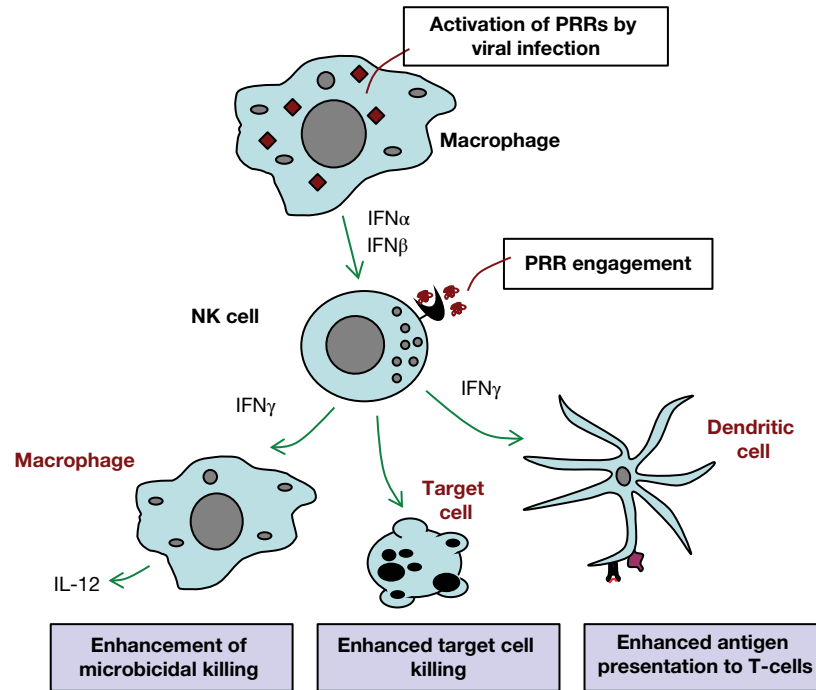


Figure 1.42 Type I interferons, or direct PAMP-mediated stimulation, activates NK cells leading to IFN γ secretion. Activated macrophages can produce type I interferons, as shown, leading to 100-fold enhancement of NK killing activity. NK cells can also be activated through direct stimulation with PAMPs. In turn, activated NK cells are an important source of IFN γ , which greatly enhances killing of intracellular microbes by macrophages and also leads to production of IL-12 by the latter. As we shall see in Chapter 8, IL-12 is an important T-cell polarizing cytokine. Production of IFN γ by NK cells also enhances antigen presentation by dendritic cells.

immune response by T-cells within the adaptive immune system (Figure 1.42). Another effect of IFN γ is to enhance the **antigen presentation** function of dendritic cells, which is also important for activation of the adaptive immune system. This cytokine can also influence the type of adaptive immune response that is mounted by helping to polarize T-cells towards a particular response pattern; we shall discuss this issue at length in Chapter 8.

Dealing with large parasites

Because most infectious agents are physically much smaller than the average macrophage or neutrophil, phagocytosis of such agents is a sensible strategy for their removal. But what happens in situations where the invading organism hopelessly dwarfs the phagocytic cells of the immune system? A close cousin of the neutrophil, the eosinophil (Figure 1.9), is important in such cases.

Eosinophils

Large parasites such as helminths cannot physically be phagocytosed and extracellular killing by eosinophils would seem to have evolved to help cope with this situation. These polymorphonuclear “cousins” of the neutrophil have distinctive granules that stain avidly with acid dyes (Figure 1.9) and have a characteristic appearance in the electron microscope (see Figure 11.25). A major basic protein is localized in the core of the granules

while an eosinophilic cationic protein together with a peroxidase have been identified in the granule matrix. Other enzymes include arylsulfatase B, phospholipase D, and histaminase. They have surface receptors for C3b and on activation produce a particularly impressive respiratory burst with concomitant generation of active oxygen metabolites. Not satisfied with that, Nature has also armed the cell with granule proteins capable of producing a transmembrane plug in the target membrane like C9 and the NK perforin. Quite a nasty cell.

Most helminths can activate the alternative complement pathway, but although resistant to C9 attack, their coating with C3b allows adherence of eosinophils through their C3b receptors. If this contact should lead to activation, the eosinophil will launch its extracellular attack, which includes the release of the major basic protein and especially the cationic protein which damages the parasite membrane.

The innate immune system instigates adaptive immunity

As we have seen throughout this chapter, any infectious agent that manages to enter the body faces a formidable array of defensive weapons, ranging from macrophage- and neutrophil-mediated phagocytosis, to complement-mediated attack, membrane perforation by defensins, and digestion by extracellular enzymes. As if all of this were not enough, the innate

immune system also plays a critical role in initiating an immune response that is uniquely tailored to the ongoing infection. This is achieved by calling upon cells of the adaptive immune system and instructing these cells in the nature of the particular antigens that are giving cause for concern. This function, called **antigen presentation**, is carried out largely, but not exclusively, by a cell that has relatively recently come to the fore as being of critical importance as a conduit between the innate and adaptive immune systems: the **dendritic cell** (DC).

Dendritic cells, which were discovered by Steinman and Cohn in 1973, are produced primarily in the bone marrow and derive their name from the multiple long membrane projections or dendrites that these cells possess (Figure 1.43). These cells share a common progenitor with macrophages, with the result that both macrophages and DCs have somewhat overlapping functions. DCs effectively grant permission for **T-cells** of the adaptive immune system to become involved in fighting an infection. They achieve this by providing such cells with **two signals** that are essential for a **naive T-cell** (i.e., one that has not previously been engaged in an immune response) to become activated and to undergo clonal expansion and differentiation to a fully fledged **effector T-cell** (i.e., capable of mounting immune responses). We will look at the role of the T-cell in the immune response in much greater detail in Chapter 8; for now it is sufficient to know that activated T-cells carry out a range of functions that reinforce the efforts of the innate immune system, by providing cytokines to help activate macrophages and attract neutrophils. Some T-cells also have functions very similar to NK cells and can detect and kill virally infected cells, while other T-cells assist in the production of antibodies, the functions of which we will deal with in the next chapter.

Dendritic cells provide a conduit between the innate and adaptive immune systems

Similar to macrophages, DCs migrate to the tissues where they reside in a quiescent state, continuously sampling their environment by phagocytosis and pinocytosis. These cells have been given various names depending on the tissue they are found in; for example the DCs in the skin are called Langerhans cells. DCs are equipped with a battery of TLRs and other PRRs and, similar to macrophages, perform a function as sentinels, waiting and watching for signs of infection or tissue damage (i.e., engagement of any of their PRRs). However, unlike the macrophage, DCs do not stand and fight upon PRR engagement but rather take flight to the nearest lymph node (which acts as a kind of army barracks for lymphocytes) to carry out a special function, called **antigen presentation**, which awakens cells of the adaptive immune system (Figure 1.44 and Figure 1.45). We will discuss this in much more detail in Chapter 5, but will quickly summarize events now as it is important that the reader is aware of the central role of DCs in adaptive immunity from the outset.

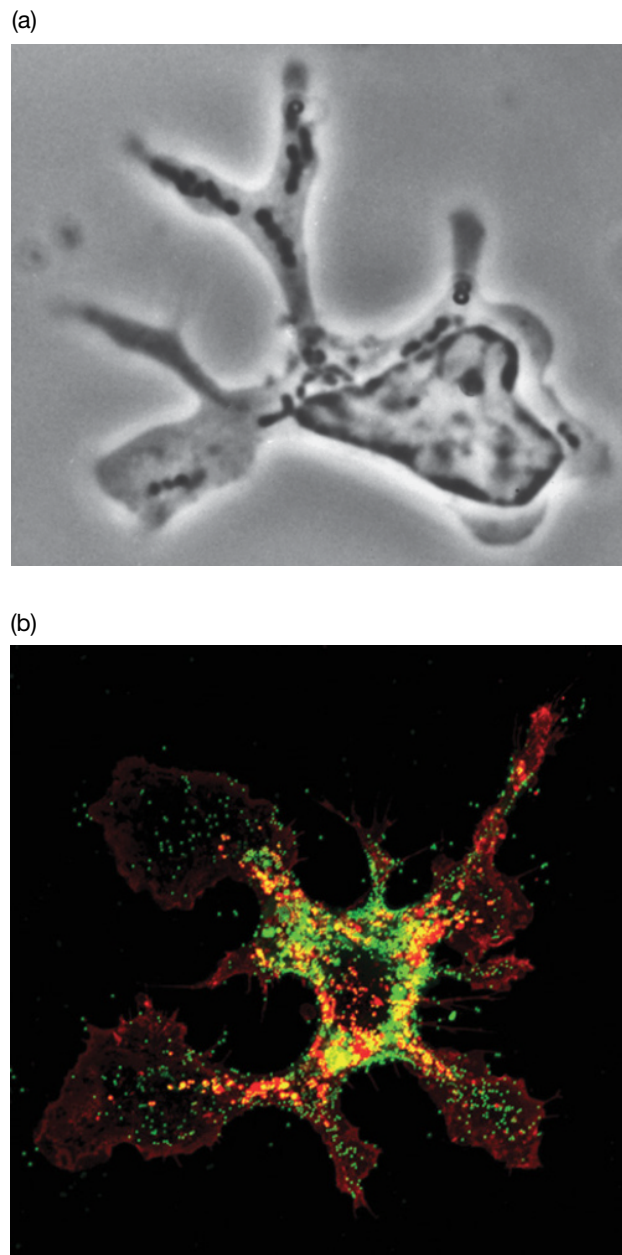


Figure 1.43 Dendritic cell morphology. (a) Phase-contrast image of an unstained dendritic cell with characteristic “dendron tree.” (Source: Dr. Ralph Steinman, The Rockefeller University, New York, USA and first published in *Mononuclear Phagocytes in Immunity, Infection, and Pathology* (ed. R. van Furth), Blackwell Scientific (1975), p. 96. Reproduced with permission of Wiley.) (b) Confocal fluorescence microscopy image of a dendritic cell that has phagocytosed green fluorescent microparticles, followed by staining the plasma membrane with Alexa-594-conjugated wheat germ agglutinin (red) to decorate surface carbohydrate. (Source: Dr. Jim Harris and Dr. Ed Lavelle, Trinity College Dublin, Ireland.)

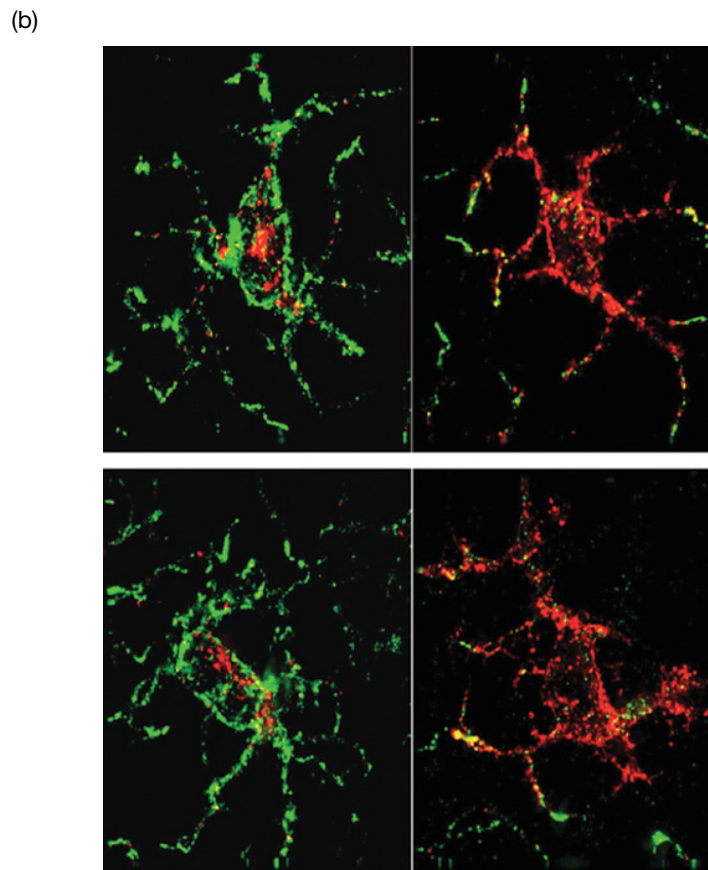
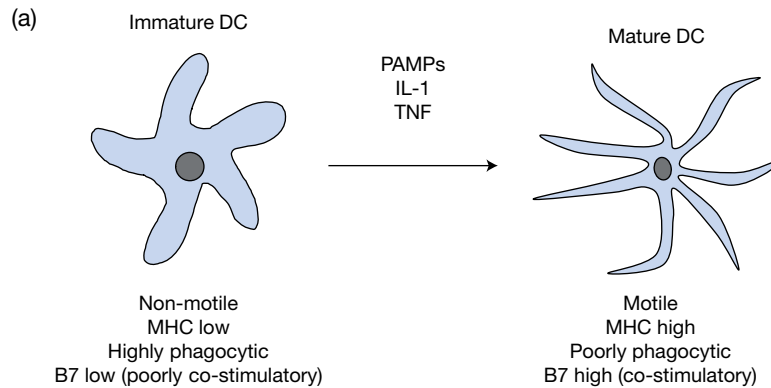


Figure 1.44 Dendritic cell maturation is induced by PAMPs and other signs of infection. (a) Immature dendritic cells (DCs) undergo maturation and become equipped to present antigen and provide co-stimulatory signals upon activation by a pathogen-associated molecular patterns (PAMPs) (or danger-associated molecular pattern (DAMP)), as this leads to a dramatic increase in the expression of surface MHC and B7 molecules on the DC. The expression of B7 family proteins is controlled by NF κ B, which is activated downstream of many PRRs. Whereas immature DCs are relatively nonmotile, mature DCs are highly motile and migrate to secondary lymphoid tissues to present antigen to T-cells. (b) Mouse epidermal Langerhans cells (i.e., DCs of the skin) were stained for langerin (green) and MHC class II (red) either before (left) or after maturation (right). Note that before DC maturation MHC class II (red) is present intracellularly, whereas after maturation it is readily detected on the cell surface. (Source: (b) Dr. Ralph Steinman and Dr. Julianna Idoyaga, The Rockefeller University, New York, USA.)

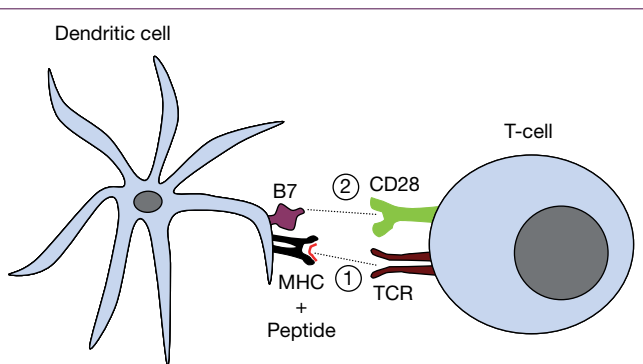


Figure 1.45 Dendritic cells (DCs) present antigen to T-cells of the adaptive immune system. MHC molecules on DCs function as serving platforms for dismembered proteins (i.e., peptides). T-cells can only “see” antigen when presented within the cleft of an MHC molecule; this represents signal 1. In addition to presenting antigen to T-cells in the correct format, DCs also give permission for T-cells to undergo clonal expansion (i.e., proliferation to increase their numbers) by providing co-stimulatory signals in the form of the membrane ligands, B7–1 and B7–2 (also called CD80/CD86), that engage with CD28 on the surface of the T-cell; this represents signal 2.

DCs present antigen to T-cells and provide co-stimulatory signals

Whereas cells of the innate immune system can directly sense nonself molecules using their panoply of PRRs, the T-lymphocytes of the adaptive immune system need to have antigen “presented” to them in a special format. Typically this involves protein antigens becoming internalized and broken down into small peptide fragments by an *antigen-presenting cell* (APC), such as a DC. Antigen presentation by the DC is achieved via a membrane complex called the *major histocompatibility complex* (MHC), which was originally discovered for its role in graft rejection (hence the unwieldy name). In essence, MHC molecules function as serving platforms for dismembered proteins and T-cells can only “see” antigen when presented within the cleft of an MHC molecule; this represents *signal 1* (Figure 1.45). T-cells inspect antigen presented on DCs using their membrane-borne *T-cell receptors* (TCRs), which are specialized for the recognition of peptide–MHC complexes. Successful triggering of a TCR results in activation and the

acquisition of various immune-related functions by the T-cell (see Chapters 7 and 8). Although DCs are the most efficient APCs for presenting antigen to T-cells, macrophages and B-cells can also perform this important function.

In addition to presenting antigen to T-cells in the correct format, DCs also give permission for T-cells to undergo clonal expansion by providing *co-stimulatory signals* in the form of the membrane ligands, B7–1 and B7–2 (also called CD80/CD86), that engage with CD28 on the surface of the T-cell; this represents *signal 2* (Figure 1.45).

Co-stimulation (i.e., signal 2) is not some afterthought on the part of the DC, for if it is absent the T-cell refuses to respond in the correct manner and will often kill itself through programmed cell death (apoptosis). Just to be sure that we are perfectly clear here, because this is critical for activation of the adaptive immune system, *naive T-cells require both signal 1 and 2 from an APC to become successfully activated*.

Engagement of PRRs equips DCs to provide co-stimulation

Because of the requirement for signals 1 and 2 for proper T-cell activation, knowing when to provide co-stimulation is a critical feature of the role of an APC. The astute reader will now be wondering how a DC knows when to provide co-stimulation, as this essentially dictates whether the adaptive immune system will be engaged or not.

Once again, PRRs provide the key to knowing when the immune system should respond or not. DCs only become equipped to provide co-stimulatory signals upon activation by a PAMP (or DAMP), as this leads to a dramatic increase in the expression of surface B7 molecules on the DC; the expression of B7 family proteins are also controlled by NFκB, which is activated downstream of many PRRs. DCs that present antigen acquired in the absence of PAMP-mediated stimulation are overwhelmingly likely to be presenting molecules derived from self and will therefore fail to provide the proper co-stimulatory signals required to activate naive T-cells (Figure 1.45).

The upshot of all of this is that the adaptive immune system is heavily reliant on cells of the innate immune system for the purposes of knowing when to initiate a response and what to respond to.

SUMMARY

The ability to recognize and respond to “nonself” as well as “hidden self” is central to immunity

- Immune responses are initiated through detection of pathogen-associated molecular patterns (PAMPs) representing nonself or danger-associated molecular patterns (DAMPs) that represent hidden self.
- Immune responses need to be proportional to the threat.
- Pattern recognition receptor molecules (PRRs), which can be either soluble (humoral) or cell-associated, are

used by the immune system to detect the presence of PAMPs or DAMPs.

- PRR engagement leads to a diversity of responses that are aimed at directly killing or engulfing microorganisms via phagocytosis, and also results in amplification of immune responses through release of a range of messenger molecules such as cytokines and chemokines.
- Interleukins represent an important class of cytokines used by leukocytes to initiate and amplify immune responses.

Immune responses are tailored towards particular types of infection

- There are different classes of pathogen (intracellular versus extracellular bacteria, viruses, yeasts, parasitic worms, unicellular parasites, fungi, etc.) and this dictates that different types of immune responses are necessary.
- PRRs decipher the molecular fingerprint of particular pathogens, thereby shaping the appropriate immune response downstream.
- Cytokines that are produced downstream of PRR engagement help to activate and trigger maturation of the appropriate classes of immune effector cells to deal with a particular type of infection.

Three levels of immune defense operate in vertebrates

- The skin and mucosal surfaces represent physical barriers to infection.
- The innate immune system is composed of a conglomeration of soluble factors and cells that detect and respond to infectious agents through binding to relatively invariant structures (PAMPs) common to many pathogens.
- The adaptive immune system is composed of T- and B-lymphocytes that recognize highly specific structures (antigens) on microorganisms via highly diverse membrane receptors that are generated randomly and are uniquely tailored to individual pathogens.
- Innate immune responses to infection are rapid (minutes) whereas adaptive immune responses are delayed (days). Innate immune responses are broadly similar between individuals within a population and do not improve upon repeated exposure to infectious agents. Adaptive immune responses differ between individuals and improve upon a second or subsequent encounter with the same antigen.
- Innate and adaptive immune responses are interdependent and cooperate to kill infectious agents.

Cells of the immune system

- The innate immune system is composed predominantly of myeloid cells, including macrophages (and their monocyte precursors), mast cells, dendritic cells, and granulocytes (neutrophils, eosinophils, and basophils). Natural killer cells, although technically lymphocytes, are also part of the innate immune system.
- Cells of the innate immune system use conserved (“hard-wired”) PAMP receptors (PRRs) that very reliably recognize highly conserved features of common pathogens, as these have been selected over millions of years of evolution.
- Innate immune cells act as sentinels of infection (macrophages, mast cells, dendritic cells) and deal with

infection through phagocytosis (macrophages, neutrophils) or can escalate immune responses through the release of soluble mediators (cytokines, chemokines, vasoactive amines) that recruit additional cells to the site of infection.

- The adaptive immune system comprises T- and B-lymphocytes that can generate new receptors for antigen in response to each new pathogen that enters the body. The antigen receptors of T- and B-lymphocytes are highly variable and are therefore prone to recognizing self and must be authenticated before use.

Barriers against infection

- Microorganisms are kept out of the body by the skin, the secretion of mucus, ciliary action, the lavaging action of bactericidal fluids (e.g., tears), gastric acid, and microbial antagonism.
- If penetration occurs, bacteria are destroyed by soluble pattern recognition molecules such as lysozyme and complement, as well as by phagocytosis followed by intracellular digestion.

Initiation of an immune response

- Macrophages play an important role in the initiation of immune responses through release of cytokines and chemokines upon detection of PAMPs. One of the effects of these cytokines and chemokines is to activate the local endothelium to permit the ingress of neutrophils and plasma proteins to the site of infection.
- There are several classes of PRR, including: Toll-like receptors (TLRs), NOD-like receptors (NLRs), C-type lectin receptors, RIG-I-like receptors (RLRs), and cytoplasmic DNA sensors (CDSs).
- PRR engagement leads to activation of phagocyte functions and to secretion of a range of cytokines and chemokines, many of which are expressed in an NFκB- and IRF-dependent manner.
- Mast cells play an important role in facilitating the vasodilation and vascular permeability that permits the recruitment of immune cells and soluble mediators to the site of infection.
- The classic inflammatory reaction has several cardinal signs (redness, swelling, pain, and heat) that are the consequence of the release of cytokines and vasoactive amines (e.g., histamine) by activated macrophages and mast cells, leading to increased plasma fluid and neutrophils/monocytes at the inflamed site, which contribute to the swelling seen.
- The combination of PRRs that are engaged at the beginning of an immune response help to decode the nature of infection. Engagement of several PRR classes simultaneously may be required for the initiation of robust immune responses.

Phagocytic cells recognize and kill microorganisms

- The main phagocytic cells are polymorphonuclear neutrophils and macrophages.
- The phagocytic cells use their membrane-localized pattern recognition receptors (PRRs) to recognize and adhere to pathogen-associated molecular patterns (PAMPs) on the microbe surface.
- Organisms adhering to the phagocyte surface activate the engulfment process and are taken inside the cell where they fuse with cytoplasmic granules.
- A formidable array of microbicidal mechanisms then comes into play: the conversion of O_2 to reactive oxygen intermediates, the synthesis of nitric oxide, and the release of multiple oxygen-independent factors from the granules.
- Neutrophils (and macrophages) can also deploy neutrophil extracellular traps (NETs), a meshwork of chromatin and granule-derived proteases that can immobilize and kill microbes.

Complement facilitates phagocytosis and lysis of microorganisms

- The complement system, a multicomponent triggered enzyme cascade, is used to attract phagocytic cells to the microbes and engulf them. Complement activation also leads to a membrane attack complex (MAC) that perforates microorganisms.
- In what is known as the alternative complement pathway, the most abundant component, C3, is split by a convertase enzyme formed from its own cleavage product C3b and factor B and stabilized against breakdown caused by factors H and I, through association with the microbial surface. As it is formed, C3b becomes linked covalently to the microorganism and acts as an opsonin.
- The next component, C5, is activated yielding a small peptide, C5a; the residual C5b binds to the surface and assembles the terminal components C6–9 into a membrane attack complex which is freely permeable to solutes and can lead to osmotic lysis.
- C5a is a potent chemotactic agent for neutrophils and greatly increases capillary permeability.
- C3a and C5a act on mast cells causing the release of further mediators, such as histamine, leukotriene B_4 , and tumor necrosis factor (TNF), with effects on capillary permeability and adhesiveness, and neutrophil chemotaxis; they also activate neutrophils.

Humoral mechanisms provide an additional defensive strategy

- A multitude of soluble pattern recognition molecules belonging to several protein families (e.g., pentraxins, collectins, ficolins) serve to detect conserved PAMPs on microorganisms. Mechanisms of action common to these

soluble PRRs upon binding their targets include: opsonization, complement activation, enhanced phagocytic uptake, and agglutination.

- In addition to lysozyme, peptide defensins, and the complement system, other humoral defenses involve the acute phase proteins, such as C-reactive and mannose-binding proteins, whose synthesis is greatly augmented by infection. Mannose-binding lectin generates a complement pathway that is distinct from the alternative pathway in its early reactions, as will be discussed in Chapter 2. It is a member of the collectin family that includes conglutinin and surfactants SP-A and SP-D, notable for their ability to distinguish microbial from “self” surface carbohydrate groups by their pattern recognition molecules.
- Recovery from viral infections can be effected by the interferons that block viral replication.

Natural killer cells instruct abnormal or virally infected cells to commit suicide

- NK cells can identify host cells that are expressing abnormal or altered patterns of proteins.
- Upon selection of an appropriate target cell, NK cells can kill by engaging either the death receptor or cytotoxic granule pathway to apoptosis.
- Both the death receptor and granule-dependent pathways to apoptosis involve activation of a group of proteases, called caspases, within the target cell that coordinate the internal dismantling of critical cellular structures, thereby killing the cell.

Dealing with large extracellular parasites

- Large infectious agents that are physically too big to be readily phagocytosed by macrophages and neutrophils are treated to a bombardment with noxious enzymes by eosinophils.
- Extracellular killing by C3b-bound eosinophils may be responsible for the failure of many large parasites to establish a foothold in potential hosts.

The innate immune system instigates adaptive immunity

- Dendritic cells (DCs) provide a conduit between the innate and adaptive immune systems by presenting antigen to T-lymphocytes within lymph nodes.
- Mature DCs present peptide fragments of antigens to T-cells via surface MHC molecules (signal 1) and also provide co-stimulatory signals via B7 family ligands (signal 2). Both signals are required for efficient T-cell activation.
- PAMP-mediated stimulation of DCs triggers their maturation (i.e., the ability to efficiently present antigen and provide co-stimulation) and promotes their migration to lymph nodes.



Now visit www.roitt.com to test yourself on this chapter.

FURTHER READING

- Banchereau J. and Steinman R.M. (1998) Dendritic cells and the control of immunity. *Nature* **392**, 245–252.
- Bottazzi B., Doni A., Garlanda C., and Mantovani A. (2010) An integrated view of humoral innate immunity: pentraxins as a paradigm. *Annual Review of Immunology* **28**, 157–183.
- Brinkmann V. and Zychlinsky A. (2012) Neutrophil extracellular traps: is immunity the second function of chromatin? *Journal of Cell Biology* **198**, 773–783.
- Cullen S.P. and Martin S.J. (2008) Mechanisms of granule-dependent killing. *Cell Death and Differentiation* **15**, 251–262.
- Gay N.J., Symmons M.F., Gangloff M., and Bryant C.E. (2014) Assembly and localization of Toll-like receptor signalling complexes. *Nature Reviews Immunology* **14**, 546–558.
- Hornung V., Hartmann R., Ablasser A., and Hopfner K.P. (2014) OAS proteins and cGAS: unifying concepts in sensing and responding to cytosolic nucleic acids. *Nature Reviews Immunology* **14**, 521–528.
- Hornung V. and Latz E. (2010) Intracellular DNA recognition. *Nature Reviews Immunology* **10**, 123–130.
- Iwasaki A. and Medzhitov R. (2010) Regulation of adaptive immunity by the innate immune system. *Science* **327**, 291–295.
- Iwasaki A. and Medzhitov R. (2015) Control of adaptive immunity by the innate immune system. *Nature Immunology* **16**, 343–353.
- Janeway C.A. Jr and Medzhitov R. (2002) Innate immune recognition. *Annual Review of Immunology* **20**, 197–216.
- Lamkanfi M. and Dixit V.M. (2012) Inflammasomes and their roles in health and disease. *Annual Reviews in Cell and Developmental Biology* **28**, 137–161.
- Matzinger P. (1994) Tolerance, danger, and the extended family. *Annual Review of Immunology* **12**, 991–1045.
- Matzinger P. (2002) The danger model: a renewed sense of self. *Science* **296**, 301–305.
- Medzhitov R. (2008) Origin and physiological roles of inflammation. *Nature* **454**, 428–435.
- Sayed B.A., Christy A., Quirion M.R., and Brown M.A. (2008) The master switch: the role of mast cells in autoimmunity and tolerance. *Annual Review of Immunology* **26**, 705–739.
- Schenten D. and Medzhitov R. (2011). The control of adaptive immune responses by the innate immune system. *Advances in Immunology* **109**, 87–124.
- Steinman R.M. and Idoyaga J. (2010) Features of the dendritic cell lineage. *Immunological Reviews* **234**, 5–17.
- Tamura T., Yanai H., Savitsky D., and Taniguchi T. (2008) The IRF family transcription factors in immunity and oncogenesis. *Annual Review of Immunology* **26**, 535–584.
- Taylor R.C., Cullen S.P., and Martin S.J. (2008) Apoptosis: controlled demolition at the cellular level. *Nature Reviews Molecular Cell Biology* **9**, 231–241.
- Van Gorp H., Kuchmiy A., Van Hauwermeiren F., and Lamkanfi M. (2014) NOD-like receptors interfacing the immune and reproductive systems. *FEBS Journal* **281**, 4568–4582.

CHAPTER 2

Specific acquired immunity

Key topics

- Antigens – “shapes” recognized by the immune system 53
- Antibody – a specific antigen recognition molecule 53
- Clonal selection 56
- Immunological memory 58
- Antigen specificity 61
- Vaccination produces acquired memory 62
- Cell-mediated immunity protects against intracellular organisms 62
- Integration of the immune response 66
- Immunopathology 66

Just to recap ...

The neutrophils, eosinophils, basophils, mast cells, monocytes, macrophages, dendritic cells, and natural killer (NK) cells are all cellular components of the innate response. Molecules involved in innate responses include the acute phase proteins and complement. Although innate responses are crucially important in protection against pathogens they are not fine-tuned to particular antigens and do not generally improve upon repeated encounters with the infectious agent, unlike the acquired responses that we will now explore.

Introduction

The acquired immune response is mediated by **lymphocytes** which come in two major varieties, **T-lymphocytes** (T-cells) and **B-lymphocytes** (B-cells). T- and B-cells possess the two defining characteristics of the acquired immune response – they are both highly antigen specific and they both exhibit immunological memory whereby they respond more vigorously upon re-encounter with specific antigen. T-cells get their name from the fact that they develop (from bone marrow precursors) in the **thymus**, an organ that overlies the lungs inside the thoracic cavity. There are three major functions carried out by T-lymphocytes: providing assistance to other cells in the immune response (**helper T-cells**), limiting excessive or undesired immune responses (**regulatory T-cells**), and killing cells infected with pathogens (**cytotoxic T-cells**). In contrast, B-cells (which develop fully within the **bone marrow**) are predominantly involved into producing **antibody**, providing what is referred to as **humoral immunity**.

Antigens – “shapes” recognized by the immune system

The structures that are recognized by the specific acquired immune response are referred to as antigens. They possess a three-dimensional shape that is complementary to the antibody molecules that act as the antigen receptor on B-lymphocytes. These antigen-specific antibody molecules are subsequently released in a soluble (secreted) version by the plasma cells derived from the B-cells following their activation. Antigens can be proteins, carbohydrates, lipids, nucleic acids, small chemical groupings referred to as haptens, in fact virtually anything. The antigens may be a component of microorganisms, of larger infectious agents such as parasitic worms, of ingested substances such as foods, of inhaled substances such as pollens, of transplanted organs or tissues, or even our own body components (“self” antigens). Just like B-cells, the other main type of lymphocyte, the T-cell, also recognizes specific antigen, although usually in the form of proteins that are digested from the original polypeptide into short peptides. The peptides are then shown to the antigen receptor on the surface of T-lymphocytes. This occurs using a molecule called MHC (major histocompatibility complex) which is specialized to show the peptides to the T-cell receptor (TCR). The T-cell therefore recognizes a shape that is a combination of antigen-derived peptide and MHC.

Antibody – a specific antigen recognition molecule

Evolutionary processes came up with what can only be described as a brilliant solution to the problem of recognizing an almost infinite diversity of antigens. This solution was to design antibody molecules in such a way that not only are they able to specifically recognize the offending pathogen but they can also recruit various components of the immune response capable of subsequently destroying the pathogen.

The antibody molecules have two main parts, one called the variable region that is devoted to binding to the individual antigen (the antigen **recognition** function) and one called the constant region, concerned with linking to complement, phagocytes, NK cells, and so forth (the **effector** function). Thus the body has to make hundreds of thousands, or even millions, of **antibody molecules with different antigen-recognition sites** but that all share the property of recruiting other elements of the immune response (Figure 2.1).

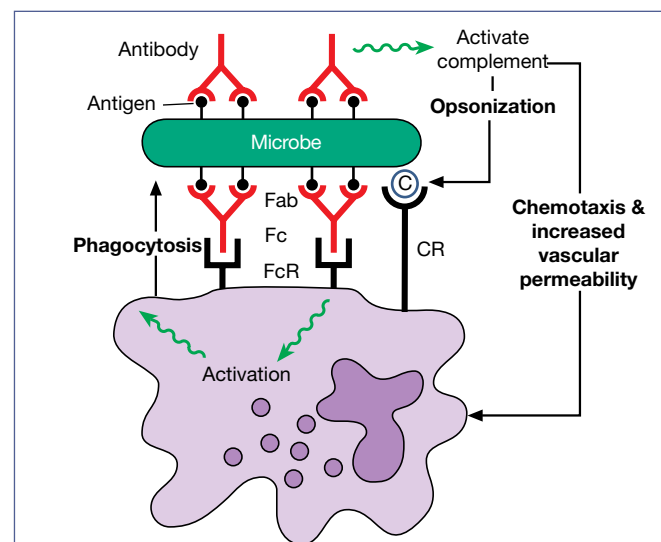


Figure 2.1 Antibody opsonizes microbes for phagocytosis both directly via Fc receptors and indirectly via complement activation. The Fab (fragment antigen-binding) part of the antibody binds specific antigen on the microbe and varies from one antibody to another. The Fc (fragment crystallizable) part is identical for all antibodies of the same class/subclass and functionally activates complement (IgM and IgG antibodies, via the classical pathway) and phagocytic cells (IgG antibody, via binding to Fc receptors [FcR] on the surface of the phagocyte). The coating of microbes with substances that are recognized by phagocytic cells is referred to as opsonization and both IgG and complement © components such as C3b, and the products of C3b breakdown iC3b, C3dg, and C3d (all of which are recognized by complement receptors [CR] on the phagocyte) can act as opsonins. In addition, complement activation leads to chemotactic attraction of the phagocytes to the site of the infection and increased vascular permeability in order to facilitate their passage from the blood circulation to the tissues.

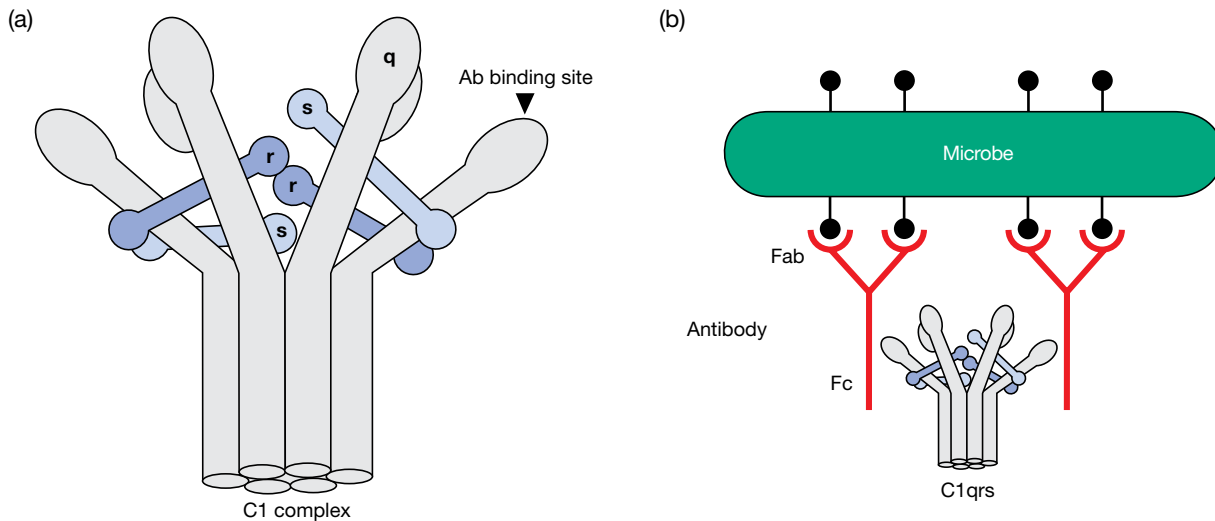


Figure 2.2 Activation of the classical complement pathway. The first component, C1, of the classical pathway of complement activation is a complex composed of three subunits: C1q, C1r, and C1s. (a) C1q forms a hexamer arranged in a “bunch of tulips”-like structure and is associated with the flexible rod-like Ca^{2+} -dependent complex C1r2–C1s2, which interdigitates with the six arms of C1q. (b) Activation of the complement cascade by the classical pathway requires antibodies to be bound to antigen in order that the globular heads of the C1q hexamer can bind to the Fc part of at least two antibodies. Certain other molecules, such as C-reactive protein, are also able to coat microbial surfaces and subsequently bind C1q to trigger the classical pathway.

Antibody-mediated activation of the classical complement pathway

Human antibodies are divided into five classes: immunoglobulin M (shortened to IgM), IgG, IgA, IgE, and IgD, which differ in the specialization of their effector “rear ends” for different biological functions. In Chapter 1 we discussed the antibody-independent alternative pathway of complement activation that relies upon stabilization of the C3bBb C3 convertase by microbial surface polysaccharides. However, the first complement pathway to be discovered, the **classical pathway**, required IgM or IgG antibody for its activation. Antibody of these two classes, when bound to antigen, will link to the first molecule in the classical pathway of complement, C1q, and trigger the proteolytic activity of the C1 complex (Figure 2.2). It was subsequently discovered that a variety of other substances, including members of the pentraxin family of soluble pattern recognition receptors such as C-reactive protein (CRP), are also able to link microbial antigens to C1q and thereby activate the classical pathway.

A C1q is a homohexamer (six identical molecules that associate together) arranged into a central stem branching into six arms, each tipped with an antibody-binding globular head. It is associated with two further subunits, C1r and C1s, in a Ca^{2+} -stabilized complex (Figure 2.2). Both C1r and C1s contain sequences called complement control protein (CCP) repeats. These are a characteristic structural feature of several proteins involved in control of the complement system. The changes that occur in C1q upon binding the antigen–antibody complex brings about the autoactivation of C1r that

then cleaves C1s. The activity of C1 is regulated by a C1-inhibitor (C1-Inh) that dissociates C1r and C1s from C1q and thus prevents excessive activation of the classical pathway.

The next component in the pathway, C4 (unfortunately components were numbered before the sequence was established), now binds to the CCPs in C1s and is then cleaved enzymatically by C1s. As expected in a multienzyme cascade, several molecules of C4 undergo cleavage, each releasing a small C4a fragment and revealing a nascent labile internal thiolester bond in the residual C4b (like that in C3, see Figure 1.31) that can then bind either to the antibody–C1 complex or to the surface of the microbe itself. In the presence of Mg^{2+} , complement component C2 can complex with the C4b to become a new substrate for the C1s: the resulting product C4b2a now has the vital **C3 convertase** activity required to cleave C3 (Figure 2.3).

The classical pathway C3 convertase has the same job as the C3bBb generated by the alternative pathway. Activation of a single C1 complex can bring about the proteolysis of literally thousands of C3 molecules. The resulting C3b is added to C4b2a to make it into a C5 convertase, which generates C5a, with chemotactic and anaphylactic functions, and C5b, which forms the first component of the **membrane attack complex** (Figure 1.33 and Figure 2.4). Just as the alternative pathway C3 convertase is controlled by factors H and I, so the breakdown of C4b2a is brought about by Factor I in the presence of either C4-binding protein (C4bp) or cell surface C3b receptor (CR1) acting as cofactors.

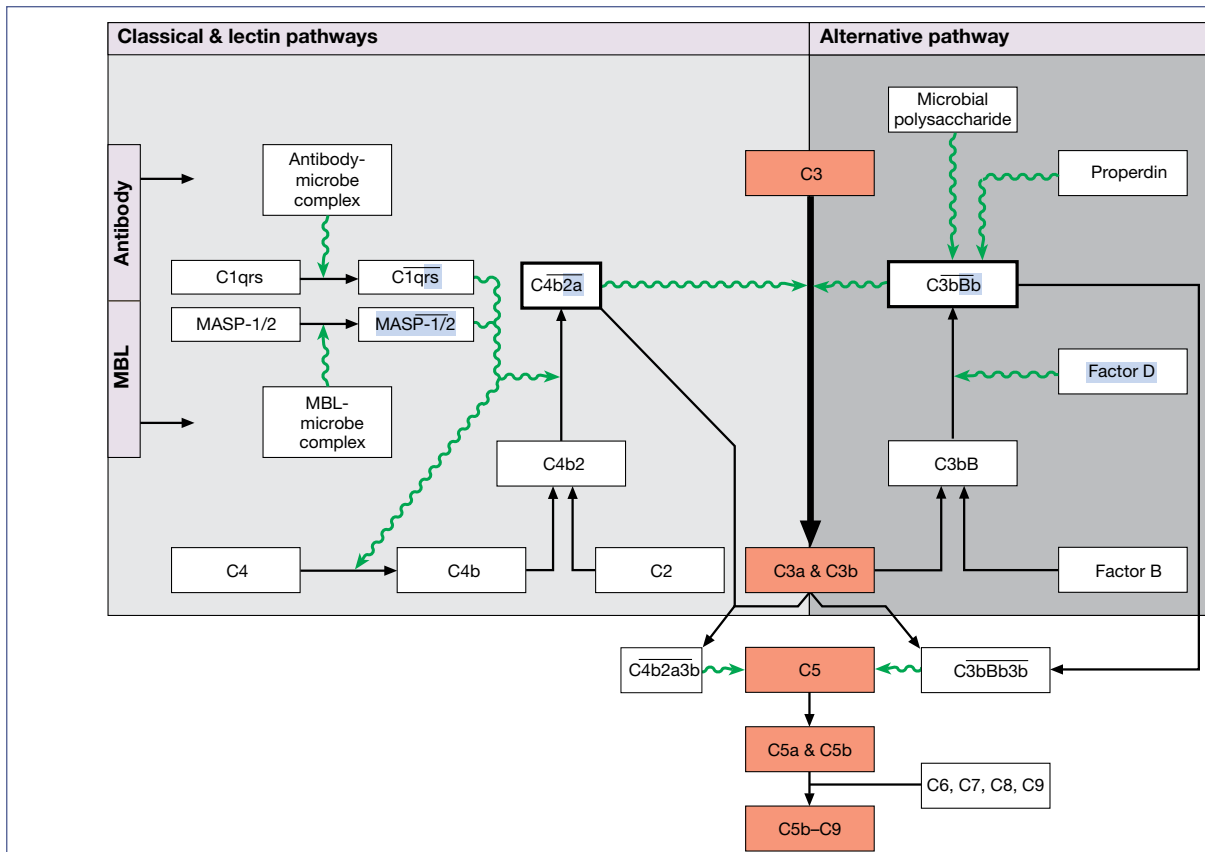


Figure 2.3 Comparison of the classical, lectin, and alternative complement pathways. The classical pathway is activated by antibody, whereas the alternative and lectin pathways are not. The molecules with protease activity are highlighted in light blue. The key central event for all three pathways is the cleavage of C3 by C3 convertase (namely C4b2a for the classical and lectin pathways, C3bBb for the alternative pathway). Beware confusion with nomenclature: the large C2 fragment that forms the C3 convertase is designated as C2a, but to be consistent with C4b, C3b, and C5b, it would have been more logical to call it C2b. Mannose-binding lectin (MBL), when combined with microbial surface sugars, associates with the MBL-associated serine proteases (MASP)-1 and -2, which split C4 and C2.

The lectin and classical complement pathways merge to generate the same C3 convertase

It is appropriate at this stage to recall the activation of complement by innate immune mechanisms involving mannose-binding lectin (MBL). On complexing with a microbe, MBL binds and activates the proteolytic activity of the MBL-associated serine proteases, MASP-1 and 2, which structurally resemble C1r and C1s respectively. In an analogous fashion to the C1qrs complex, MASP-1 and MASP-2 split C4 and C2 to generate the C4b2a C3 convertase (Figure 2.3).

Irrespective of whether activation occurs via the classical, lectin, or alternative pathway (indeed, all three pathways will often be activated in response to a particular infection although the classical pathway will have to wait for the arrival of antibody), several biologically active complement components are generated that have important roles in the immune response (Figure 2.5).

Antibody can activate phagocytosis

Microorganisms are sometimes able to resist phagocytosis. If small amounts of antibody are added the phagocyte springs into action. It does so through the recognition of two or more antibody molecules bound to the microbe, using specialized Fc receptors on the cell surface of the phagocyte (Figure 2.1).

A single antibody molecule complexed to the microorganism is not enough because it cannot cause the cross-linking of the Fc receptors on the phagocyte surface membrane that is required to activate the cell. There is a further consideration connected with what is often called the *bonus effect of multivalency*. For thermodynamic reasons, which will be discussed in Chapter 5, the association constant of ligands that use several rather than a single bond to react with receptors is increased geometrically rather than arithmetically. For example, three antibodies bound close together on a bacterium could be bound to a macrophage a thousand times more strongly than a single antibody molecule (Figure 2.6).

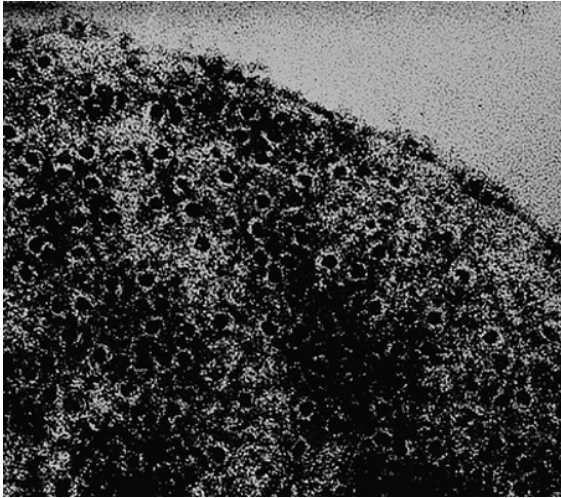


Figure 2.4 Multiple punctures in the cell wall of *Escherichia coli* bacterium caused by interaction with IgM antibody and complement. Each puncture is caused by a single IgM molecule and shows as a “dark pit” owing to penetration by the “negative stain.” This is somewhat of an illusion as in reality these “pits” are like volcano craters standing proud of the surface, and are each single membrane attack complexes. Comparable results may be obtained in the absence of antibody by using higher concentrations of complement as the cell wall endotoxin can activate the alternative pathway ($\times 400\ 000$). (Source: R. Dourmashkin and J.H. Humphrey. Reproduced with permission.)

Other activities of antibody

In addition to the activation of complement and the facilitation of phagocytosis, antibodies mediate a variety of other functions, including participation in a process referred to as antibody-dependent cellular cytotoxicity (ADCC), formation of immune complexes to enable the removal of antigen from the circulation, and, for the IgE class of antibody, triggering of mast cell and basophil degranulation (Figure 2.7). Aside from working with other components of the immune system, antibodies can directly neutralize the binding of viruses to their cell surface receptors, prevent adhesion of bacteria to body surfaces and neutralize bacterial toxins.

Antibodies are made by lymphocytes

The central role of the lymphocyte in the production of antibody was established largely by the work of James Gowans. He depleted rats of their lymphocytes by chronic drainage of lymph from the thoracic duct using an indwelling cannula, and showed that they had a grossly impaired ability to mount an antibody response to microbial challenge. The ability to form antibody could be restored by injecting thoracic duct lymphocytes obtained from another rat of the same strain.

The majority of resting *lymphocytes* are relatively small cells (approximately $10\ \mu\text{m}$ diameter) with a darkly staining nucleus due to condensed chromatin and with relatively little cytoplasm (Figure 2.8a) containing the odd mitochondrion required for

basic energy provision (Figure 2.8b). They are derived from hematopoietic stem cells in the bone marrow which can develop into the common lymphoid progenitors that give rise to both the antibody-producing B-cells and to the T-cells (Figure 2.9). The B-cells can be divided into two populations (B-1 and B-2), and the T-cells can be divided into those with a $\gamma\delta$ T-cell receptor and those with an $\alpha\beta$ T-cell receptor. T-cells, particularly those with an $\alpha\beta$ TCR, can be further divided on the basis of their function into helper T-cells, regulatory T-cells, and cytotoxic T-cells. The helper T-cells provide assistance for B-cells, cytotoxic T-cells, and macrophages (Figure 2.10).

Clonal selection

Antigen selects those lymphocytes that possess the specific receptor

Each B-cell is programmed to make one, and only one, specificity of antibody and it places a transmembrane version of these antibodies on its cell surface to act as receptors for the specific antigen. These antibodies can be detected by using fluorescent probes and, in Figure 2.8c, one can see the molecules of antibody on the surface of a human B-lymphocyte stained with a fluorescent rabbit antiserum raised against a preparation of human antibodies. Each B-lymphocyte has of the order of 10^5 antibody molecules, all of identical antigen specificity, on its surface. The B-cells give rise to plasma cells (Figure 2.8d,e), which produce large amounts of soluble antibody in their rough endoplasmic reticulum (Figure 2.8f). The antibody is then secreted from the plasma cells into the local environment and can circulate, become attached to cells bearing Fc receptors, or be transported to mucosal surfaces.

When an antigen enters the body, it is confronted by a dazzling array of B-lymphocytes all bearing different antibodies each with its own individual recognition site. The antigen will only bind to those receptors with which it makes a good fit. B-lymphocytes whose receptors have bound antigen receive a triggering signal and can then develop into either plasma cells or memory B-cells. As the B-lymphocytes are programmed to make only one specificity of antibody, the soluble version of the antibody molecule secreted by the plasma cell will recognize the same antigen as the cell surface transmembrane version originally acting as the antigen receptor. In this way, antigen selects for the production of the antibodies that recognize it effectively (Figure 2.11a). T-cells with a TCR of appropriate specificity are similarly selected (Figure 2.11b), which can include the T-helper cells that are required in most cases to help B-cells proliferate and subsequently differentiate into plasma cells.

The need for clonal expansion means humoral immunity must be acquired

Because we can make hundreds of thousands, maybe even millions, of different antibody molecules, it is not feasible for us to have too many lymphocytes producing each type of

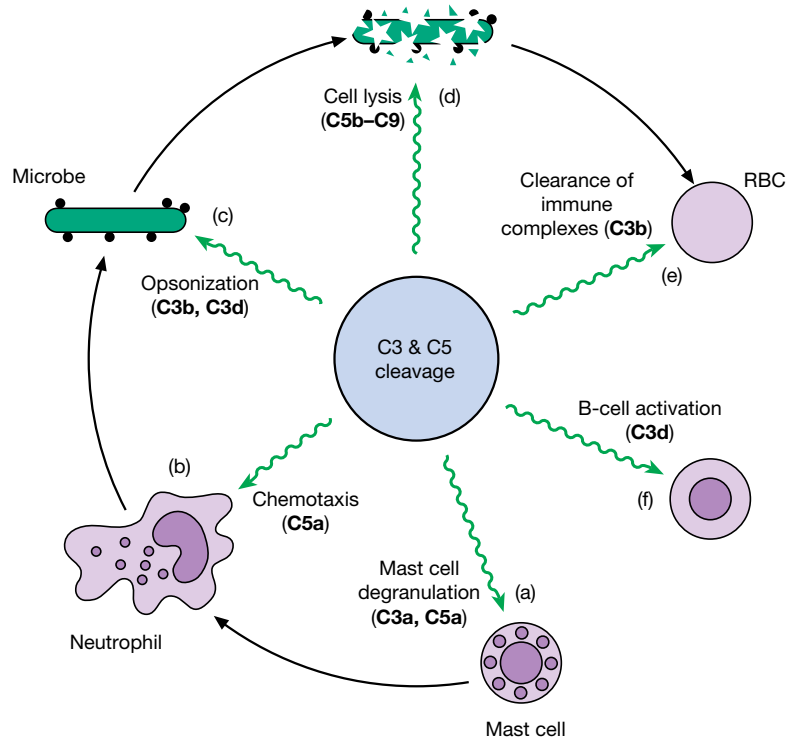


Figure 2.5 Activities generated by the triggering of the complement cascade. Following the cleavage of C3 by C3 convertase and subsequently of C5 by C5 convertase, various biologically active complement components are generated. Various cells of the immune system possess cell surface receptors for particular complement components, and microbial cell surfaces can become coated with complement. The functions that are generated work together to generate an effective immune response. Thus the release of inflammatory mediators from mast cells (a) occurring in response to complement components C3a and C5a (and to a lesser extent C4a) leads to an increase in vascular permeability. This allows neutrophils (b) to exit the circulation in response to an additional activity of C5a as a neutrophil chemoattractant. Microorganisms (c) opsonized with, for example, C3b and C3d, are effectively phagocytosed by these neutrophils due to the phagocytes expressing complement receptors. Once C5 convertase is deposited on the microbial surface, the terminal components (C5b–C9) of the complement system can assemble to form the membrane attack complex (MAC) with subsequent destruction of microorganisms (d). Because erythrocytes (e) bear complement receptors they are able to bind antigens that are coated in complement, and these are rapidly transported to the spleen and liver for destruction. Complement component C3d acts to facilitate B-cell (f) activation by providing co-stimulation via complement receptors on the B-cell and/or by mediating the retention of immune complexes on follicular dendritic cells, and thereby is involved in the generation of specific antibody against the microbe.

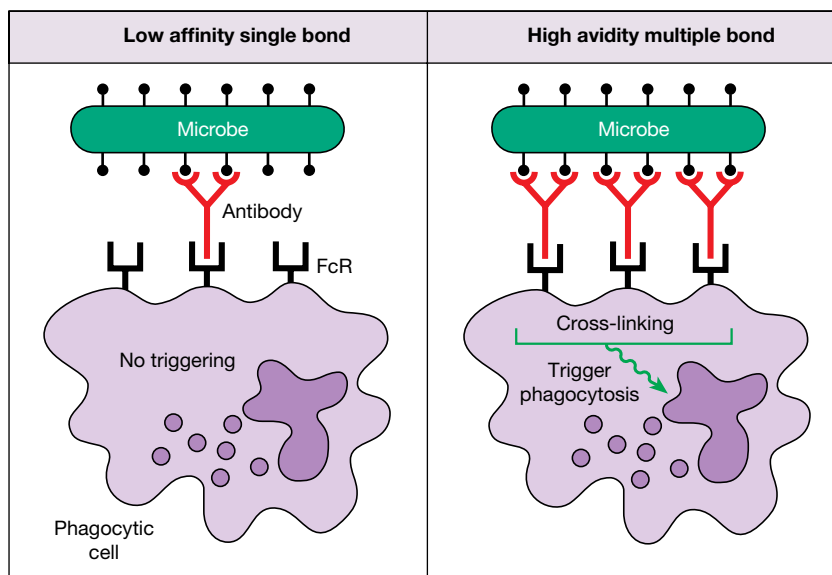


Figure 2.6 Antibody-mediated activation of phagocytosis. Binding of a bacterium to a phagocyte by multiple antibodies gives strong association forces and triggers phagocytosis by cross-linking the surface Fc receptors (FcR).

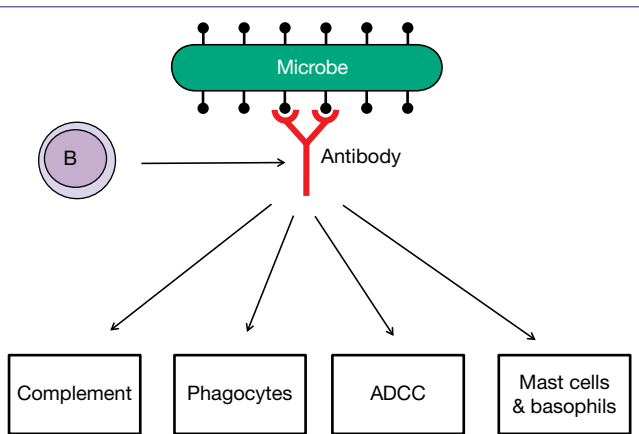


Figure 2.7 The antibody molecule links the pathogen to other components of the immune response. Antibody provides a link between the infectious agent and the complement system (via the classical pathway), phagocytic cells such as neutrophils and macrophages, with killer cells (NK cells, eosinophils, etc.) via a mechanism referred to as antibody-dependent cellular cytotoxicity (ADCC), and in the case of IgE antibodies to mast cells and basophils.

antibody; there just would not be enough room in the body to accommodate them. To compensate for this, lymphocytes that are triggered by contact with antigen undergo successive waves of proliferation to build up a large clone of plasma cells that will be making antibody of the kind for which the parent lymphocyte was programmed. By this system of **clonal selection**, large enough concentrations of specific antibody can be produced to combat infection effectively (Milestone 2.1; Figure 2.11a). Clonal selection of T-lymphocytes similarly ensures that only cells of the appropriate specificity are induced to proliferate.

The importance of proliferation for the development of a significant antibody response is highlighted by the ability of antimetabolic drugs, which prevent cell division, to completely abolish antibody production to a given antigen stimulus.

Because it takes time for the proliferating clone to build up its numbers sufficiently, it is usually several days before antibodies are detectable in the serum following primary contact with antigen. The newly formed antibodies, and newly expanded T-cells, are a consequence of antigen exposure and it is for this reason that we speak of the **acquired (adaptive) immune response**.

Immunological memory

When we make an immune response to a given infectious agent, by definition that microorganism must exist in our environment and we are likely to meet it again. It would make sense then for the immune mechanisms alerted by the first contact with antigen to leave behind some memory system that would enable the response to any subsequent exposure to that particular antigen to be faster and greater in magnitude.

Our experience of many common infections tells us that this must be so. We rarely suffer twice from such diseases as measles, mumps, chickenpox, whooping cough, and so forth. The first contact clearly imprints some information, imparts some **memory**, so that the body is effectively prepared to repel any later invasion by that organism and a state of immunity is established.

Secondary immune responses are better

By following the production of antibody and of effector T-cells on the first and second contacts with antigen, we can see the basis for the development of immunity. For example, when we inject a bacterial product such as tetanus toxoid into a rabbit, for the reasons already discussed, several days elapse before antibody production by B-cells can be detected in the blood; these antibodies reach a peak and then fall (Figure 2.12). If we now allow the animal to rest and then give a second injection of toxoid, the course of events is dramatically altered. Within 2–3 days the antibody level in the blood rises steeply to reach much higher values than were observed in the **primary immune response**. This **secondary immune response** then is characterized by a more rapid and more abundant production of antibody resulting from the “tuning up” or priming of the antibody-forming system. T-lymphocytes similarly exhibit enhanced secondary responses, producing cells with improved helper or cytotoxic effector functions.

The fact that it is the lymphocytes that are responsible for immunological memory can be demonstrated by **adoptive transfer** of these cells to another animal, an experimental system frequently employed in immunology. The immunological potential of the transferred cells is seen in a recipient treated with X-rays that destroy its own lymphocyte population; thus the recipient animal acts as a living “test tube” in which the activity of the transferred lymphocytes can be assessed *in vivo*. Lymphocytes taken from an animal given a primary injection of antigen (for example, either tetanus toxoid or influenza hemagglutinin) and transferred to an irradiated host, which is then boosted with the same antigen, give a rapid, intense production of antibody characteristic of a secondary response (Figure 2.13a,d). To exclude the possibility that the first antigen injection might exert a **nonspecific** stimulatory effect on the lymphocytes, “criss-cross” control animals are boosted by injection with a different antigen to that given for the primary injection. In these control animals only primary responses are seen to either antigen (Figure 2.13b,c). We have explained the design of the study in detail to call attention to the need for careful selection of controls in immunological experiments.

The higher response given by a primed lymphocyte population is due to the presence of T and B memory cells which not only form a quantitatively expanded population of antigen-specific lymphocytes (Figure 2.11) but also are functionally enhanced in comparison to the original naive lymphocytes from which they were derived.

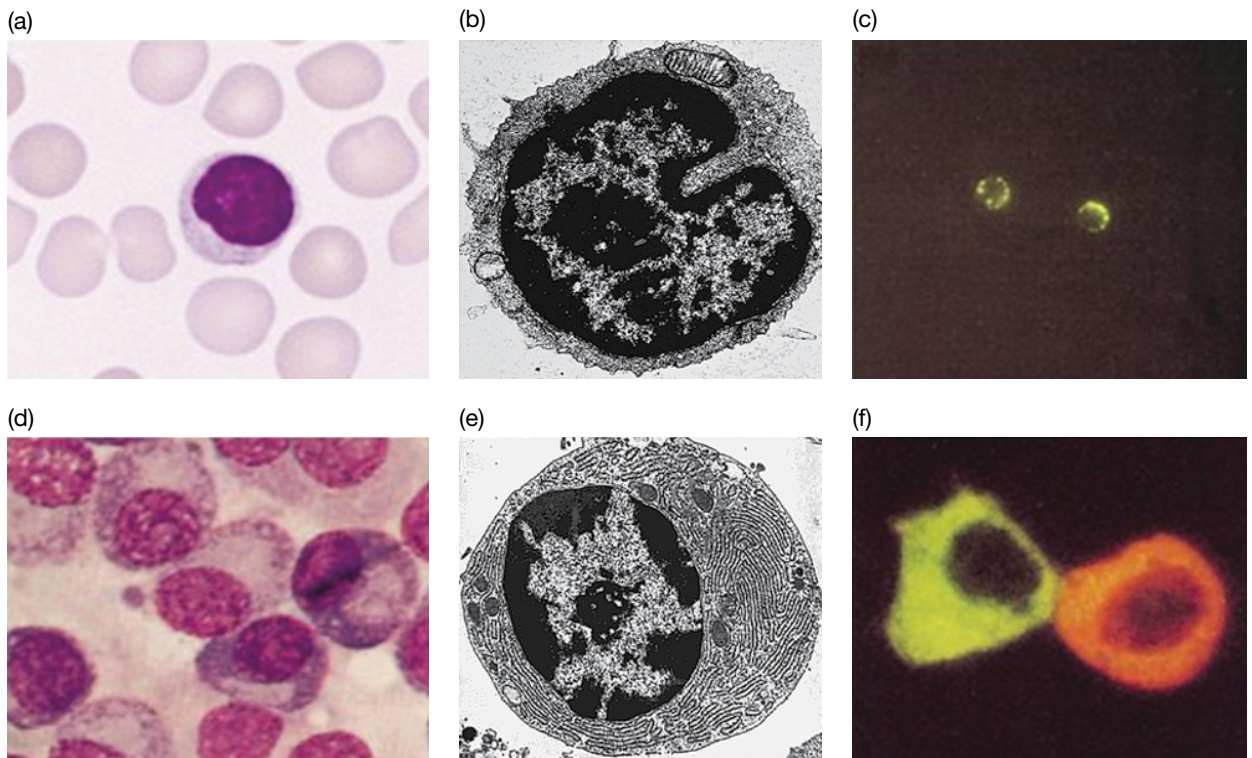


Figure 2.8 Cells involved in the acquired immune response. (a) Small lymphocyte. Typical resting lymphocyte with a thin rim of cytoplasm. Condensed chromatin gives rise to heavy staining of the nucleus. Giemsa stain. (Source: A.V. Hoffbrand, J.E. Pettit, and P.A.H. Moss (2006) *Essential Haematology*, 5th edn. Reproduced with permission of Wiley.) (b) Electron micrograph of a lymphocyte with an indented nucleus containing condensed chromatin, sparse cytoplasm: single mitochondrion shown ($\times 13\ 000$) (Source: A. Zicca. Reproduced with permission.) (c) Immunofluorescence staining of B-lymphocyte surface immunoglobulin using fluorescein-conjugated (green) anti-Ig. (Source: P. Lydyard. Reproduced with permission.) (d) Plasma cells. The nucleus is eccentric. The cytoplasm is strongly basophilic owing to high RNA content. The juxtannuclear lightly stained zone corresponds with the Golgi region. May–Grünwald–Giemsa. (Source: C. Grossi. Reproduced with permission.) (e) Electron micrograph of a plasma cell. Prominent rough-surfaced endoplasmic reticulum associated with the synthesis and secretion of Ig ($\times 10\ 000$). (f) Plasma cells fixed with acetic acid and ethanol and subsequently stained to show intracellular immunoglobulin using a fluorescein-labeled anti-IgG (green) and a rhodamine-conjugated anti-IgM (red). (Source: C. Grossi. Reproduced with permission.)

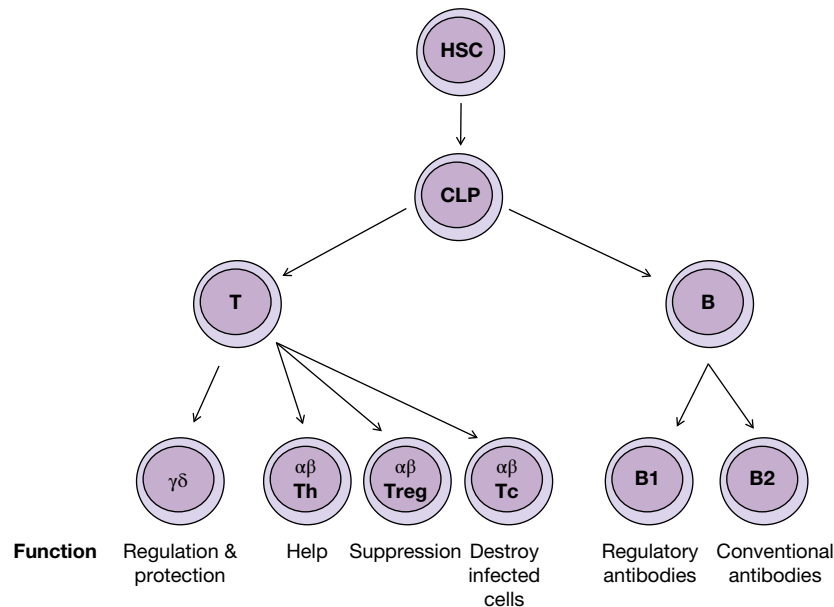


Figure 2.9 The different types of lymphocyte are all derived from a common lymphoid progenitor. Hematopoietic stem cells (HSC) can develop down either the myeloid or lymphoid pathways of cellular differentiation, but all lymphocytes are derived via the latter route. Thus the common lymphoid progenitor (CLP) produces both T- and B-lymphocytes. The T-lymphocytes can possess either a $\gamma\delta$ or an $\alpha\beta$ T-cell receptor (TCR). Those with an $\alpha\beta$ T-cell receptor are functionally divided into helpers (Th), regulatory suppressors (Treg), and cytotoxic (Tc) cells. The major division of B-cells is into the B-1 and B-2 populations.

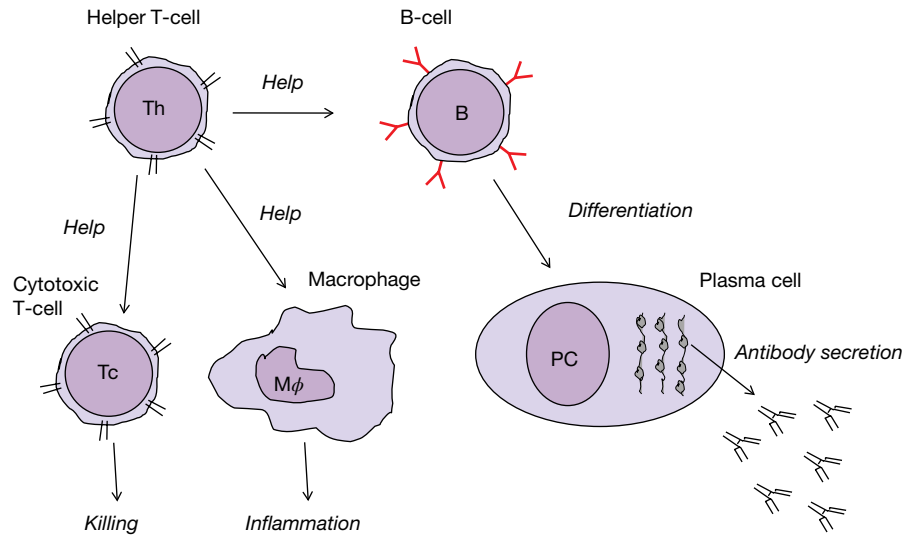


Figure 2.10 Helper T-cells assist other cells in the immune response. The helper T-cell population are involved in activating cytotoxic T-cells, can activate macrophages (particularly via the secretion of the cytokine γ -interferon) and are obligatory for most B-cell responses.

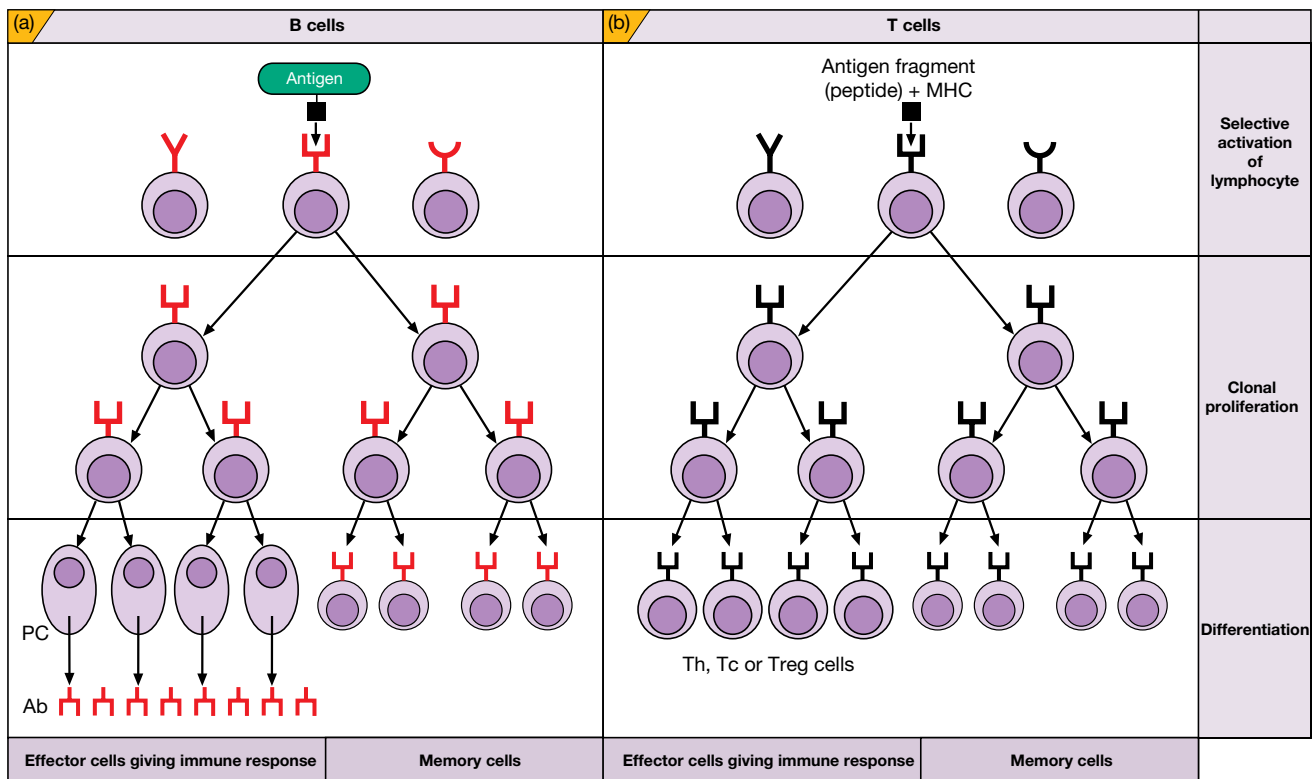


Figure 2.11 Antigen activates those lymphocytes with a complementary antigen receptor. This process is referred to as clonal selection and ensures that only the relevant, antigen-specific, lymphocytes are triggered to produce the appropriate effector cells and memory cells. (a) In the case of the antibody-producing B-lymphocytes they use a cell surface version of the antibody, which directly binds native antigen, as the B-cell receptor (BCR). (b) T-lymphocytes do not make antibody but also possess a cell surface antigen receptor, the T-cell receptor (TCR) which recognizes processed protein antigen fragments presented to it by MHC molecules (see Figure 2.14 and Figure 2.15). Following their activation by antigen, lymphocytes undergo repeated cell division (clonal proliferation) and the progeny give rise to an expanded population of antigen-specific cells. A fraction of the progeny of the original antigen-reactive lymphocytes become memory cells whereas others differentiate into effector cells. In the case of B-lymphocytes the effector cells are the antibody-secreting plasma cells (PC), whereas for T-lymphocytes the effector cells may be T-helper cells (Th), cytotoxic T-cells (Tc) or regulatory T-cells (Treg).



Milestone 2.1 Clonal selection theory

Antibody production according to Ehrlich

In 1894, well in advance of his time as usual, the remarkable Paul Ehrlich proposed the side-chain theory of antibody production. Each cell would make a large variety of surface receptors that bound foreign antigens by complementary shape “lock and key” fit. Exposure to antigen would provoke overproduction of receptors (antibodies), which would then be shed into the circulation (Figure M2.1.1).

Template theories

Ehrlich's hypothesis implied that antibodies were preformed prior to antigen exposure. However, this view was difficult to accept when later work showed that

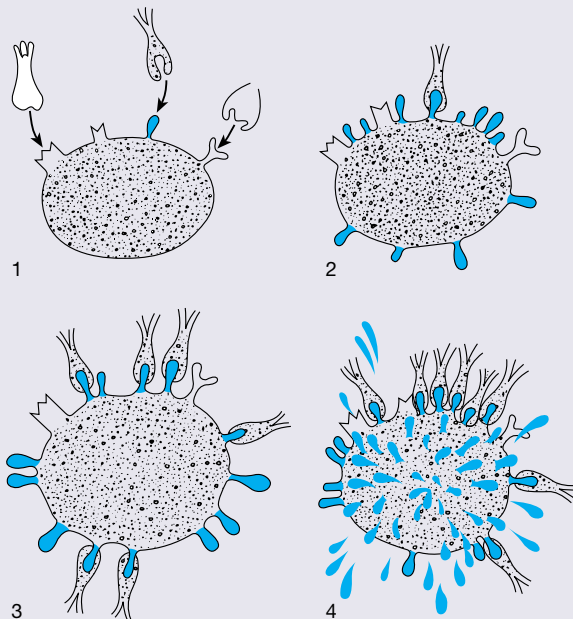


Figure M2.1.1 Ehrlich's side-chain theory of antibody production. (Source: *Proceedings of the Royal Society B* (1900), 66, 424.)

antibodies could be formed to almost any organic structure synthesized in the chemist's laboratory (e.g., *m*-aminobenzene sulfonate; Figure 5.6) despite the fact that such molecules would never be encountered in the natural environment. Thus was born the idea that antibodies were synthesized by using the antigen as a template. Twenty years passed before this idea was “blown out of the water” by the observation that, after an antibody molecule is unfolded by guanidinium salts in the absence of antigen, it spontaneously refolds to regenerate its original specificity. It became clear that each antibody has a different amino acid sequence that governs its final folded shape and hence its ability to recognize antigen.

Selection theories

The wheel turns full circle and we once more live with the idea that, as different antibodies must be encoded by separate genes, the information for making these antibodies must pre-exist in the host DNA. In 1955, Nils Jerne perceived that this could form the basis for a selective theory of antibody production. He suggested that the complete antibody repertoire is expressed at a low level and that, when antigen enters the body, it selects its complementary antibody to form a complex that in some way provokes further synthesis of that particular antibody. But how?

Frank Macfarlane Burnet now brilliantly conceived of a cellular basis for this selection process. Let each lymphocyte be programmed to make its own singular antibody that is inserted like an Ehrlich “side-chain” into its surface membrane. Antigen will now form the complex envisaged by Jerne, on the surface of the lymphocyte, and by triggering its activation and clonal proliferation, large amounts of the specific antibody will be synthesized (Figure 2.11). Bow graciously to that soothsayer Ehrlich, he came so close in 1894!

Antigen specificity

Discrimination between different antigens

The establishment of immunity to one microorganism does not confer protection against another unrelated microorganism. After an attack of measles we are immune to further infection but are susceptible to other agents such as the chickenpox or mumps viruses if these have not been encountered. Acquired immunity shows **specificity** and the immune system can differentiate specifically between the two organisms. A more formal experimental demonstration of this discriminatory power was seen in Figure 2.13, where priming with tetanus toxoid evoked memory for that antigen but not for influenza hemagglutinin and vice versa.

The basis for this lies of course in the ability of the recognition sites of the antigen-receptor molecules to distinguish between antigens; antibodies that react with the toxoid do not bind to influenza and, *mutatis mutandis* as they say, anti-influenza does not recognize the toxoid. Similarly, T-cell receptors are specific for a given peptide (plus MHC) sequence derived from the antigen.

Discrimination between self and nonself

This ability to recognize one antigen and distinguish it from another goes even further. The individual must also recognize what is foreign (i.e., what is “nonself”). The failure to

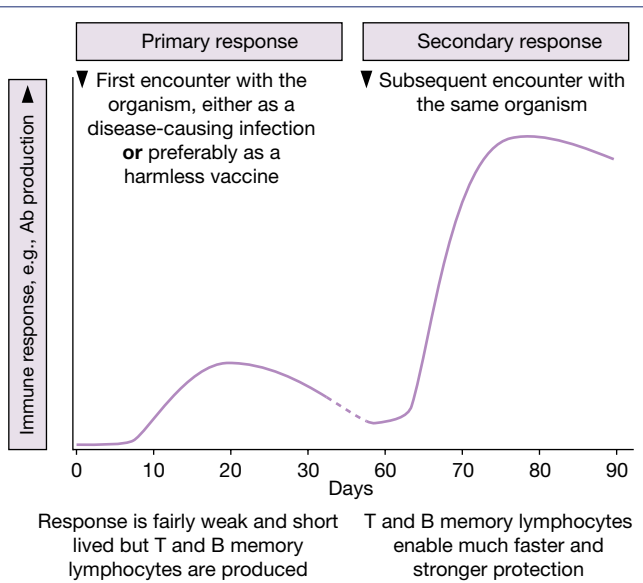


Figure 2.12 Primary and secondary response. The first encounter with an antigen, for example associated with a pathogenic organism, elicits a primary immune response that is rather slow to get going because it takes a while for the naive lymphocytes to expand up to sufficient numbers. The response is not of great magnitude and fades relatively quickly. The response on the second contact with the same antigen is much more rapid and more intense. Memory cells generated during the primary response are both quantitatively and qualitatively superior to the naive lymphocytes, requiring fewer cycles of cell division before they develop into effectors. The generation of memory cells provides the basis for vaccination, where the immune response is primed by a relatively harmless form of the microbial antigen so that the immune system goes straight into making a secondary immune response upon the first encounter with the actual pathogen.

discriminate between *self* and *nonself* could lead to the synthesis of antibodies (*autoantibodies*) directed against components of the subject's own body, which might prove highly damaging. On purely theoretical grounds it seemed to Frank Macfarlane Burnet and Frank Fenner that the body must develop some mechanism whereby "self" and "nonself" could be distinguished, and they postulated that those circulating body components that were able to reach the developing lymphoid system in the perinatal period could in some way be "learnt" as "self." A permanent unresponsiveness or *tolerance* would then be created so that as immunological maturity was reached there would normally be an inability to respond to "self" components. Burnet argued that if, following clonal selection, each set of lymphocytes were making their own individual specific antibody, those cells programmed to express antibodies reacting with circulating self components could be rendered unresponsive without affecting other lymphocytes specific for foreign antigens. In other words, self-reacting lymphocytes could be selectively suppressed or tolerized without undermining the ability of the host to respond immunologically to infectious agents. As we

shall see in Chapter 10, these predictions have been amply verified, although we will learn that, as new lymphocytes differentiate throughout life, they will all go through this self-tolerizing screening process. However, self tolerance is not absolute and normally innocuous but potentially harmful anti-self lymphocytes exist in all of us.

Vaccination produces acquired memory

In 1796, Edward Jenner carried out the remarkable clinical experiment that marks the beginning of immunology as a systematic subject. Noting the pretty pox-free skin of the milkmaids, he reasoned that deliberate exposure to the pox virus of the cow, which is not virulent for the human, might confer protection against the related human smallpox organism with which it has some antigenic similarity. Accordingly, he inoculated a small boy with cowpox and was delighted and presumably breathed a sigh of relief to observe that the boy was now protected against a subsequent exposure to smallpox (what would today's ethical committees have said about that?!). By injecting a harmless form of a disease organism, Jenner had utilized the specificity and memory of the acquired immune response to lay the foundations for modern *vaccination* (Latin *vacca*, cow).

The strategy is to prepare a nonpathogenic form of the infectious organism or its toxins that still substantially retains the antigens responsible for establishing memory cells and protective immunity (Figure 2.12). This procedure can be done by using killed or live attenuated organisms, purified microbial components or chemically modified antigens.

Cell-mediated immunity protects against intracellular organisms

The term *cell-mediated immunity* is used to describe the responses of *T-cells*, particularly with respect to the ability of some types of T-helper cells to activate macrophages and the ability of cytotoxic T-lymphocytes to directly kill infected cells. Many microorganisms live inside host cells where it is usually impossible for humoral antibody to reach them. *Obligate intracellular pathogens* such as viruses have to replicate inside cells; *facultative intracellular pathogens* such as *Mycobacterium* and *Leishmania* can replicate within cells, particularly macrophages, but do not have to; they like the intracellular life because of the protection it affords. The T-cells are specialized to operate against cells bearing intracellular organisms. Their *T-cell receptor (TCR)* for antigen, which is different from the antibody molecule used by B-lymphocytes, does not directly recognize intact antigen. Instead it recognizes antigen that is first *processed* by the cell in which it is located and then subsequently *presented* to the T-cell. This rather more convoluted mechanism required for antigen recognition is necessary in order that the T-cell sees antigen in association with a cell, rather than non-cell-associated antigens such as extracellular bacteria that can be dealt with by antibody. Protein













	1st injection of antigen	Transfer small lymphocytes to irradiated recipient	Boost with antigen	Measure antibody response to:	
				Tetanus toxoid	Influenza hemagglutinin
a	Tetanus toxoid 		Tetanus toxoid 	Secondary	-
b	Tetanus toxoid 		Influenza hemagglutinin 	Primary	Primary
c	Influenza hemagglutinin 		Tetanus toxoid 	Primary	Primary
d	Influenza hemagglutinin 		Influenza hemagglutinin 	-	Secondary

Figure 2.13 Memory for a primary response can be transferred by small lymphocytes. Recipients are treated with a dose of X-rays that directly kill lymphocytes (highly sensitive to radiation) but only affect other body cells when they divide; the recipient thus permits the function of the donor cells to be followed. The reasons for the design of the experiment are given in the text.

antigens within cells are chewed up by intracellular proteases to generate short **peptides**. These peptides then need to be taken to the cell surface in order for them to be recognized by the TCR on the T-cells. It is highly unlikely that, if unaccompanied, the peptides would stay on the cell surface. Without a transmembrane sequence they would simply fall off the surface of the cell and float away – not much use if the T-cell needs to attach to the particular cell that is infected. An important group of molecules known as the **major histocompatibility complex (MHC)**, identified originally through their ability to evoke powerful transplantation reactions in other members of the same species, carry out the function of transporting the peptides to the cell surface and then displaying them to the TCR on T-cells. Most T-cells thus recognize **peptide + MHC** rather than the intact native antigen recognized by B-cells.

In general, **cytotoxic T-cells** recognize peptides presented by the **MHC class I** molecules that are present on virtually all nucleated cells in the body. In contrast, **helper and regulatory T-cells** usually recognize peptides presented by the **MHC class II** molecules that are, in addition to MHC class I molecules, present on so-called “professional antigen-presenting cells”: the interdigitating dendritic cell, the macrophage and the B-lymphocyte. Naive (virgin) T-cells (i.e., those that have not previously encountered their antigen) must be shown the

peptide antigen and MHC by the most powerful type of antigen-presenting cell, the interdigitating dendritic cell, before they can be activated. However, once primed, T-cells can be activated by peptide antigen and MHC present on the surface of macrophages (or B-cells) as we shall now see.

Cytokine-producing T-cells help macrophages to kill intracellular pathogens

Organisms that are able to survive inside macrophages do so through their ability to subvert the innate killing mechanisms of the phagocyte. Nonetheless, they mostly cannot prevent the macrophage from processing small antigenic fragments (possibly of organisms that have spontaneously died) and placing them on the host cell surface. **T-helper cells**, if primed to that antigen, will recognize and bind to the combination of antigen peptide with **class II** MHC molecules on the macrophage surface and produce a variety of soluble factors termed **cytokines**. Some T-cell cytokines help B-cells to make antibodies, while others such as interferon- γ (IFN γ) serve as **macrophage activating factors** that switch on the previously subverted microbicidal mechanisms of the macrophage and thereby bring about the death of the intracellular microorganisms (Figure 2.14).

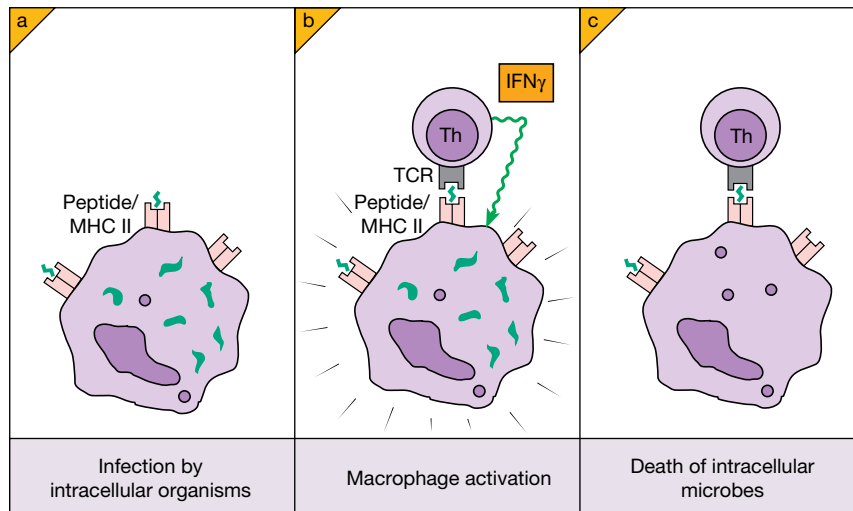


Figure 2.14 Intracellular killing of microorganisms by macrophages. (a) An antigen peptide (S) derived from the intracellular microbes is complexed with cell surface class II MHC molecules (□). (b) The primed T-helper cell binds to this MHC–peptide complex using its T-cell receptor (TCR) and is triggered to release the cytokine γ -interferon ($\text{IFN}\gamma$). This process activates microbicidal mechanisms in the macrophage. (c) The infectious agent meets a timely death.

Using acquired immunity to deal with virally infected cells

We have already discussed the advantage to the host of killing virally infected cells before the virus begins to replicate and have seen that NK cells can carry out a cytotoxic function via their activating receptors (Figure 2.15a and Table 4.3). These receptors inherently have a limited range of specificities. However, NK cells also possess receptors for the constant (Fc) part of the antibody molecule (as discussed earlier with regard to phagocytic cells). This situation enables their range of potential targets to be enormously expanded because the Fc receptors can recognize virus-specific antibody coating the target cell if any intact viral antigens are present on the surface of the infected cell. Thus antibodies generated by the acquired immune response will bring the NK cell very close to the target by forming a bridge, and the NK cell being activated by the complexed antibody molecules is able to kill the virally infected cell by its extracellular mechanisms (Figure 2.15b). This system is termed **antibody-dependent cellular cytotoxicity (ADCC)**.

However, as previously mentioned a **subset of T-cells with cytotoxic capabilities** also exists. Like the T-helpers, these cells have a very wide range of antigen specificities because they clonally express a large number of different TCRs. Like the T-helper cell, the **cytotoxic T-cells** recognize fragments of protein antigens (peptides) in association with a cell marker, in this case the **class I MHC** molecule (Figure 2.15c). Through this recognition of surface antigen, the cytotoxic cell comes into intimate contact with its target and administers the “kiss of apoptotic death.” It also releases **$\text{IFN}\gamma$** that will help to reduce the spread of virus to adjacent cells, particularly in cases where the virus itself may prove to be a weak inducer of $\text{IFN}\alpha$ or β .

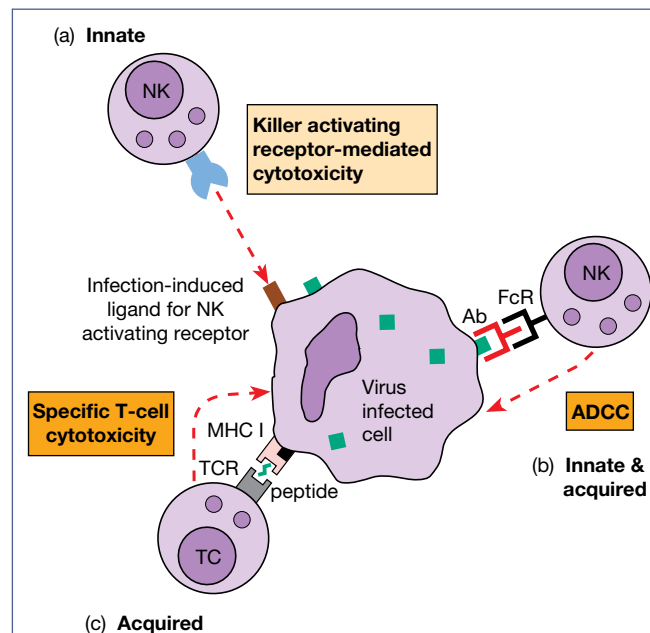


Figure 2.15 Killing virally infected cells. (a) Destruction of infected cells by the natural killer (NK) cells of the innate response can follow their recognition by the killer activating receptors. (b) In addition to the direct recognition by these receptors, NK cells possess Fc receptors and can therefore recognize any virus-specific antibodies that are bound to any intact viral antigens present on the surface of infected cells. This is therefore an example of the innate and acquired responses working together to defeat the enemy and, in this case, is referred to as antibody-dependent cellular cytotoxicity (ADCC). (c) The cytotoxic T-cells of the acquired response recognize the infected target cell specifically through TCR recognition of virally derived peptides presented by MHC class I molecules.

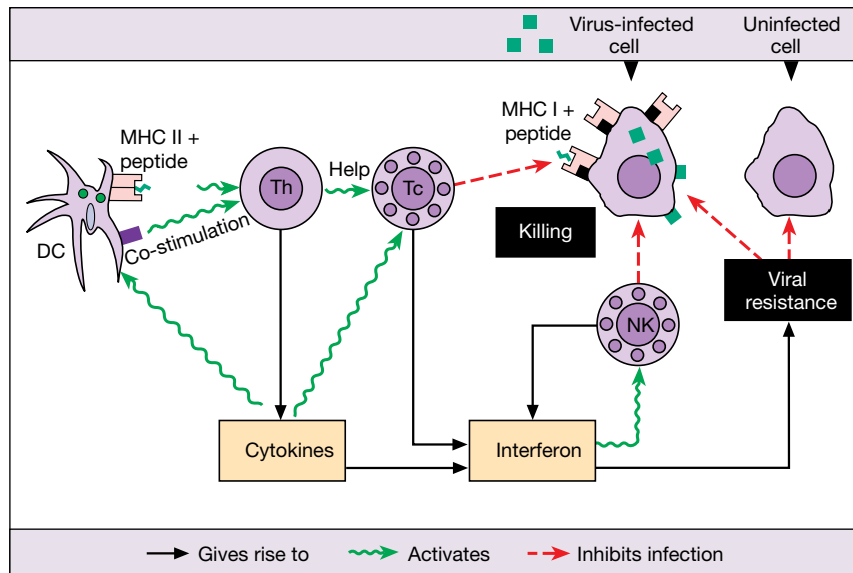


Figure 2.16 T-cells link with the innate immune system to combat intracellular infection. Class I (MHC I) and class II (MHC II) major histocompatibility molecules are important for T-cell recognition of antigen. Dendritic cells (DC) utilize MHC class II plus peptide, together with a range of co-stimulatory molecules, in order to activate T-helper cells (Th). These then help activate cytotoxic T-cells (Tc) and further activate the DCs. Interferon from both the Th and Tc cells inhibits viral replication and stimulates natural killer (NK) cells that themselves produce more interferon and, together with Tc, kill virus-infected cells. The interferon also sets up a state of viral resistance in the surrounding uninfected cells.

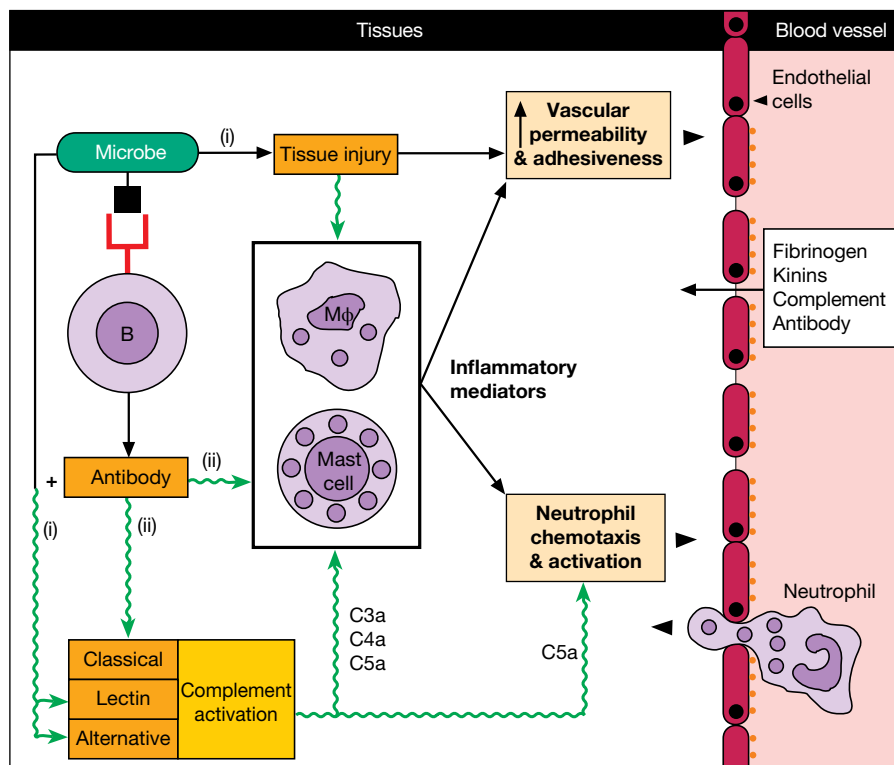


Figure 2.17 Production of a protective acute inflammatory reaction by microbes either: (i) through tissue injury (e.g., bacterial toxin) or direct activation of the alternative or lectin complement pathways, or (ii) by antibody-dependent triggering of the classical complement pathway or mast cell degranulation (a special class of antibody, IgE, does this).

Thus both T- and B-cells provide *specific acquired immunity* with a variety of mechanisms, which in most cases operate to extend the range of effectiveness of innate immunity and confer the valuable advantage that a first infection prepares us to withstand further contact with the same infectious organism. The defining characteristic of the acquired response is that it is mediated by *lymphocytes*, which in contrast to the cells of the innate response are highly *antigen specific* and exhibit strong immunological *memory*. It is, however, worth noting two important points at this juncture. First, the innate and acquired responses usually work together to defeat the pathogen and, second, that these two systems merge into one another, with some cell types having characteristics that bridge both kinds of response.

Integration of the immune response

It should by now be becoming clear that the innate and acquired responses are not two entirely separate systems but rather they form a continuum with multiple points of interaction. Thus dendritic cells and NK cells (innate) work with helper T-cells and cytotoxic T-cells (acquired) to limit the infection of cells with a virus (Figure 2.16). To give just one other example, antibodies (acquired) can contribute to an acute inflammatory response mediated by neutrophils, macrophages, and mast cells (innate) (Figure 2.17).

Immunopathology

The immune system is clearly “a good thing,” but like mercenary armies, it can turn to bite the hand that feeds it, and cause damage to the host (Figure 2.18).

Thus when there is an especially heightened response or persistent exposure to exogenous antigens, tissue damaging or *hypersensitivity* reactions may result. Examples are *allergy* to grass pollens, immune complex glomerulonephritis occurring after streptococcal infection, and chronic granulomas produced during tuberculosis or schistosomiasis.

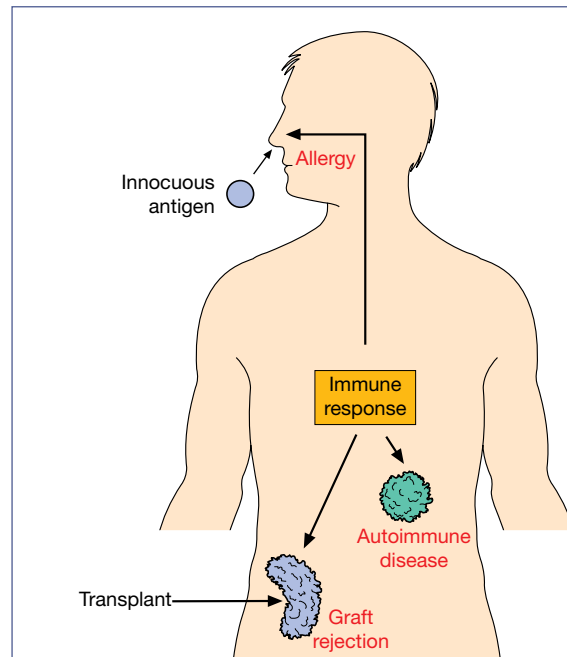


Figure 2.18 Inappropriate immune responses can produce damaging reactions, such as the allergic response to inhaled otherwise innocuous antigens (allergens), the destruction of self tissue by autoimmune attack, and the rejection of tissue transplants.

In other cases, responses to autoantigens may arise through a breakdown in the mechanisms that control self tolerance, and a wide variety of *autoimmune diseases*, such as type 1 (insulin-dependent) diabetes and multiple sclerosis and many of the rheumatologic disorders, may result from an autoimmune attack.

Another immunopathologic reaction of some consequence is *graft rejection*, in which the MHC antigens on the donor transplant may well provoke a fierce reaction.

Antigen

- Antigens recognized by the immune system can be proteins, carbohydrates, lipids, or many other types of molecule.
- They have a conformation that is complementary to that of the antibodies that act as the antigen receptors on B-cells and to the secreted antibody molecules produced by the plasma cells that develop from the antigen-stimulated B-cell.
- The antigen receptors on T-cells, the T-cell receptor (TCR), generally recognize protein antigens that have been processed into short peptides and are then presented to the TCR by major histocompatibility complex (MHC) molecules.

- Components of foreign agents and also our own body components can act as antigens.

Antibody, the specific antigen-recognition molecule

- The antibody molecule evolved to attach to microorganisms and focus other components of the immune response onto the infectious agent.
- The antibody binds to the antigen by its specific recognition site and its constant regions activate complement through the classical pathway (binding C1 and generating a C4b2a convertase to split C3) and phagocytes through their Fc receptors.
- This route into the acute inflammatory reaction is enhanced by IgE antibodies that sensitize mast cells and

by immune complexes that stimulate mediator release from tissue macrophages.

- The innate immune reaction of mannose-binding lectin with microbes activates the MASP-1 and MASP-2 proteases, which join the classical complement pathway by splitting C4 and C2.

Cellular basis of antibody production

- Antibodies are secreted by plasma cells derived from B-lymphocytes, each of which is programmed to make antibody of a single specificity that is placed on the cell surface as a receptor for antigen.
- Antigen binds to the B-cell bearing a complementary antibody, activates it, and causes clonal proliferation and finally differentiation into antibody-secreting plasma cells and memory B-cells. Thus the antigen brings about clonal selection of the cells making antibody to that particular antigen.

Acquired memory and vaccination

- The increase in memory cells after priming means that the acquired secondary response is faster and greater, providing the basis for vaccination using a harmless form of the infective agent for the initial encounter.

Acquired immunity has antigen specificity

- Antibodies differentiate between antigens because recognition is based on molecular shape complementarity. Thus memory induced by one antigen will not extend to another unrelated antigen.
- The immune system differentiates self components from foreign antigens by making immature self-reacting lymphocytes unresponsive through contact with the constantly present host molecules; lymphocytes reacting with foreign antigens are unaffected as (given that infection is usually a transient event) they normally only make contact after reaching maturity.

Cell-mediated immunity protects against intracellular organisms

- Another class of lymphocyte, the T-cell, is concerned with control of intracellular infections. Like the B-cell, each T-cell has its individual antigen receptor (the TCR, which differs structurally from antibody) that recognizes antigen and the cell then undergoes clonal expansion to form effector and memory cells providing specific acquired immunity.
- The T-cell recognizes processed protein antigens (peptides) in association with MHC molecules. Naive T-cells are only stimulated to undergo a primary response by specialized dendritic antigen-presenting cells.
- Primed T-helper cells, which see antigen as peptides with class II MHC on the surface of professional antigen-presenting cells (dendritic cells, macrophages and B-lymphocytes), release cytokines that in some cases can help B-cells to make antibody and in others activate macrophages and enable them to kill intracellular pathogens.
- Cytotoxic T-cells have the ability to recognize specific antigen peptides plus class I MHC on the surface of virally-infected cells. The infected cells are then killed to prevent the virus replicating. T-cells also release γ -interferon, which can make surrounding cells resistant to viral spread.
- The NK cells of the innate response can work together with the antibodies of the acquired response by recognizing antibody-coated virally-infected cells through their Fc γ receptors. They then kill the target by ADCC.
- Although the innate mechanisms do not strongly improve with repeated exposure to infection as do the acquired, they play a vital role as they are intimately linked to the acquired systems by **two different pathways** that all but **encapsulate the whole of immunology**. Antibody,

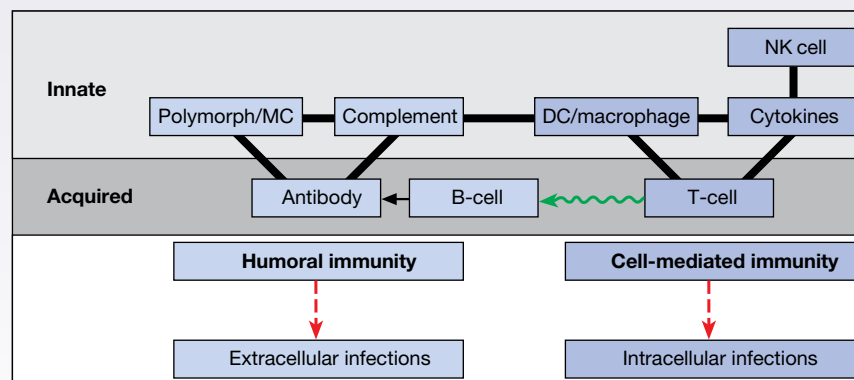


Figure 2.19 The two pathways linking innate and acquired immunity that provide the basis for humoral and cell-mediated immunity, respectively.

complement, polymorphs (neutrophils, eosinophils, and basophils) and mast cells (MC) give protection against most extracellular organisms, while T-cells, soluble cytokines, dendritic cells (DC), macrophages, and natural killer (NK) cells deal with intracellular infections (Figure 2.19).

Immunopathology

- Immunopathologically mediated tissue damage to the host can occur as a result of: inappropriate hypersensitivity reactions to exogenous antigens; loss of tolerance to self giving rise to autoimmune disease; or reaction to foreign grafts.



Now visit www.roitt.com to test yourself on this chapter.

FURTHER READING

- Berke G. and Clark W.R. (2007) *Killer Lymphocytes*. Springer, Dordrecht, The Netherlands. 369 pp.
- Borghesi L. and Milcarek C. (2007) Innate versus adaptive immunity: a paradigm past its prime? *Cancer Research* **67**, 3989–3993.
- Cohn M., Mitchison N.A., Paul W.E., Silverstein A.M., Talmage D.W., and Weigert M. (2007) Reflections on the clonal-selection theory. *Nature Reviews Immunology* **7**, 823–830.
- Holers V.M. (2014) Complement and its receptors. *Annual Review of Immunology* **32**, 433–459.
- Iwasaki A. and Medzhitov R. (2015) Control of adaptive immunity by the innate immune system. *Nature Immunology* **16**, 343–353.
- Ricklin D., Hajishengallis G., Yang K., and Lambris J.D. (2010) Complement: a key system for immune surveillance and homeostasis. *Nature Immunology* **11**, 785–797.
- Silverstein A.M. (2009) *A History of Immunology*, 2nd edn. Academic Press, San Diego, CA.
- Vantourout P. and Hayday A. (2013) Six-of-the-best: unique contributions of $\gamma\delta$ T cells to immunology. *Nature Reviews Immunology* **13**, 88–100.

CHAPTER 3

Antibodies

Key topics

- The division of labor 70
- Five classes of immunoglobulin 70
- The IgG molecule 72
- The structure and function of the immunoglobulin classes 77
- Genetics of antibody diversity and function 86

Roitt's Essential Immunology, Thirteenth Edition. Peter J. Delves, Seamus J. Martin, Dennis R. Burton, and Ivan M. Roitt.
© 2017 John Wiley & Sons, Ltd. Published 2017 by John Wiley & Sons, Ltd.
Companion website: www.roitt.com

Just to recap ...

In order to resist the onslaught of a myriad of pathogens, we have evolved general mechanisms of defense (innate immunity) and mechanisms that are specific for a given pathogen (specific acquired or adaptive immunity). The latter mechanism, as its name implies, can be acquired and optimized through contact with the pathogen or through vaccination. The key players in specific immunity are antibodies and T-cells. In this chapter, we consider antibodies in some detail.

Introduction

In essence, antibody molecules carry out two principal functions in immune defense. The **first function** is to recognize and bind to foreign material (antigen). This generally means binding to molecular structures on the surface of the foreign material (antigenic determinants) that differ from molecular structures made by the cells of the host. These antigenic determinants are usually expressed in multiple copies on the foreign material, such as proteins or carbohydrates on a bacterial cell surface or envelope spikes on the surface of a virus. Antibodies of a single host can recognize a huge variety of different molecular structures – a human is capable of producing antibodies against billions of different molecular structures. This is described as antibody diversity and is necessary to respond to the huge diversity of molecular structures associated with (often highly mutable) pathogens.

The simple act of antibody binding may be sufficient to inactivate a pathogen or render a toxin harmless. For instance, antibody coating of a virus can prevent entry into target cells and thereby “neutralize” the virus. However, in many instances, a **second function** of the antibody molecule is deployed to trigger the elimination of foreign material. In molecular terms, this involves the binding of certain molecules (effector molecules) to antibody-coated foreign material to trigger complex elimination mechanisms, such as the complement system of proteins, phagocytosis by host immune cells (e.g., neutrophils and macrophages), and antibody-dependent cellular cytotoxicity (ADCC) by NK cells. The powerful effector systems are generally triggered only by antibody molecules clustered together as on a foreign cell surface and not by free unliganded antibody. This is crucial considering the typically high serum concentrations of antibodies.

The division of labor

The requirements imposed on the antibody molecule by the two functions are, in a sense, quite opposite. The first function requires great antibody diversity. The second function requires that many different antibody molecules share common features; for instance, it is not practical for Nature to devise a different molecular solution for the problem of elimination of antigens for each different antibody molecule. The conflicting requirements are elegantly met by the antibody structure shown diagrammatically in Figure 3.1. The structure consists

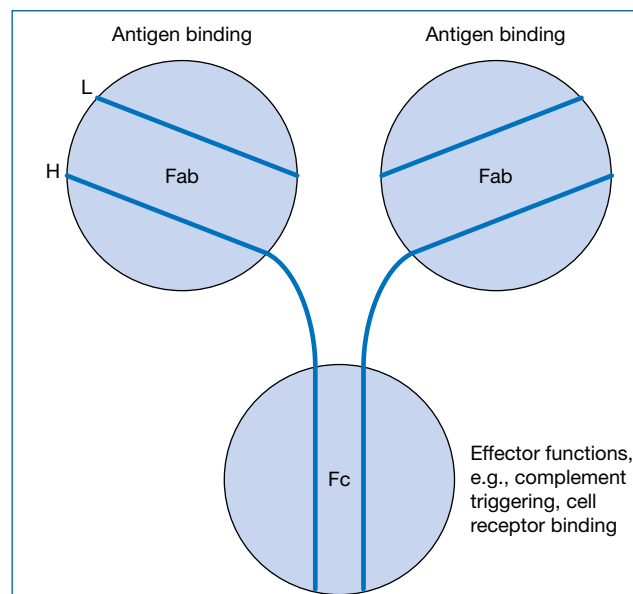


Figure 3.1 Simplified overall layout of the antibody molecule. The structure consists of four polypeptide chains, two identical heavy (H) chains and two identical light (L) chains, arranged to span three structural units as shown. The two identical Fab units bind antigen and the third unit (Fc) binds effector molecules to trigger antigen elimination and to mediate functions such as maternal–fetal transport.

of three units. Two are identical to one another and are involved in binding to antigen. These are the **Fab (fragment antigen binding)** arms of the molecule. These units contain regions of sequence that vary greatly from one antibody to another and confer on a given antibody its unique binding specificity. The presence of two identical Fab arms enhances the binding of antibody to antigen in the typical situation where multiple copies of antigenic determinants are presented on foreign material. The third unit – **Fc (fragment crystallizable)** – is involved in binding to effector molecules. As shown in Figure 3.1, the antibody molecule has a four-chain structure consisting of two identical heavy chains spanning Fab and Fc and two identical light chains associated only with Fab. The relationship between antigen binding, the different units and the four-chain structure of the antibody molecule were revealed by a series of key experiments that are summarized in Milestone 3.1.

Five classes of immunoglobulin

Antibodies are often referred to as **immunoglobulins** (immune proteins). There are five classes of antibodies or immunoglobulins, termed immunoglobulin G (IgG), IgM, IgA, IgD, and IgE. All these classes have the basic four-chain antibody structure but they differ in their heavy chains, which are termed γ , μ , α , δ , and ϵ , respectively. The differences are most pronounced in the Fc regions of the antibody



Milestone 3.1 Four-polypeptide structure of immunoglobulin monomers

Early studies showed the bulk of the antibody activity in serum to be in the slow electrophoretic fraction termed γ -globulin (subsequently immunoglobulin). The most abundant antibodies were divalent (i.e., had two combining sites for antigen and could thus form a precipitating complex).

To Rodney Porter and Gerald Edelman must go the credit for unlocking the secrets of the basic structure of the immunoglobulin molecule. If the internal disulfide bonds are reduced, the component polypeptide chains still hang together by strong noncovalent attractions. However, if the reduced molecule is held under acid conditions, these attractive forces are lost as the chains become positively charged and can now be separated by gel filtration into larger, so-called heavy chains of approximately 55 000 Da (for IgG, IgA, and IgD) or 70 000 Da (for IgM and IgE) and smaller light chains of about 24 000 Da.

The clues to how the chains are assembled to form the IgG molecule came from selective cleavage using proteolytic enzymes. Papain destroyed the precipitating power of the intact molecule but produced two univalent Fab fragments still capable of binding to antigen (Fab – **fragment antigen binding**); the remaining fragment had no affinity for antigen and was termed Fc by Porter (**fragment crystallizable**). After digestion with pepsin a molecule called $F(ab')_2$ was isolated; it still precipitated antigen and so retained both binding sites, but the Fc portion was further degraded. The structural basis for these observations is clearly evident from Figure M3.1.1. In essence, with minor changes, all immunoglobulin molecules are constructed from one or more of the basic four-chain units.

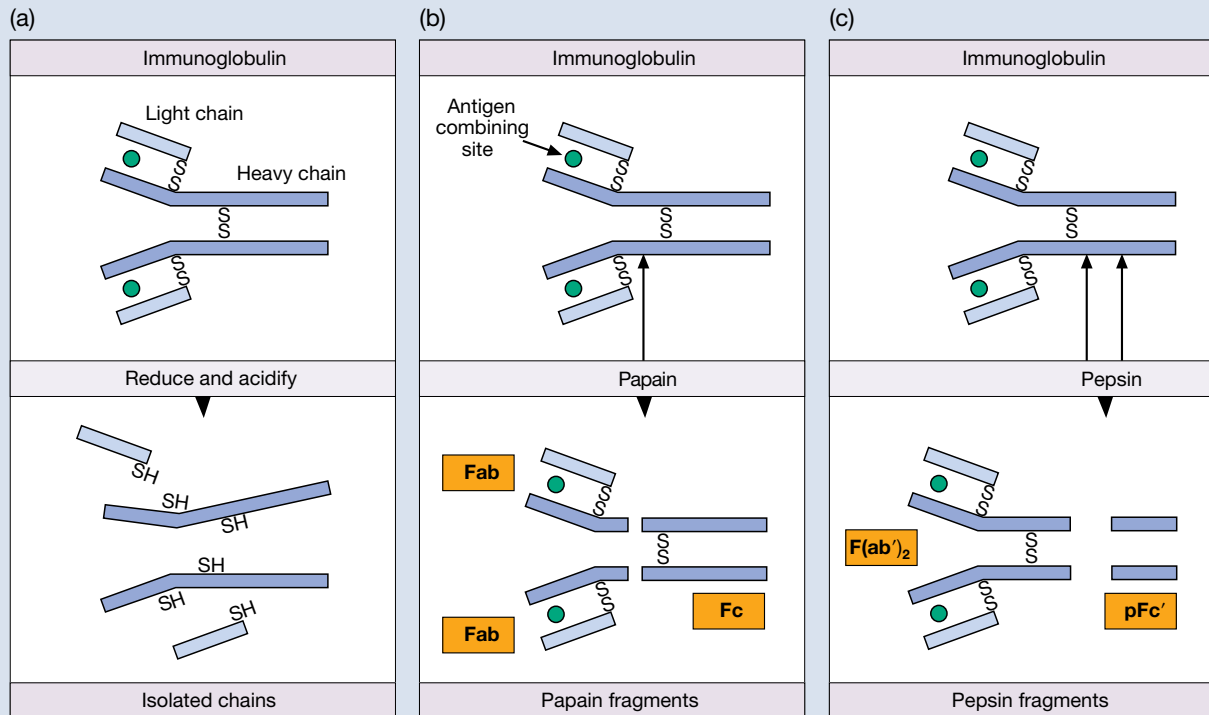


Figure M3.1.1 The antibody basic unit (IgG is represented), consisting of two identical heavy and two identical light chains held together by interchain disulfide bonds (a), can be broken down into its constituent polypeptide chains and to proteolytic fragments, the pepsin $F(ab')_2$ retaining two binding sites for antigen (c) and the papain Fab with one (b). After pepsin digestion the pFc' fragment representing the C-terminal half of the Fc region is formed and is held together by noncovalent bonds. The portion of the heavy chain in the Fab fragment is given the symbol Fd. The N-terminal residue is on the left for each chain.

classes and this leads to the triggering of different effector functions on binding to antigen. For example, IgM recognition of antigen might lead to complement activation, whereas IgE recognition (possibly of the same antigen) might lead to mast cell degranulation and anaphylaxis (increased vascular permeability and smooth muscle contraction). These differences

are discussed in greater detail later. Structural differences also lead to differences in the polymerization state of the monomer unit shown in Figure 3.1. Thus, IgG and IgE are generally monomeric, whereas IgM occurs as a pentamer. IgA occurs predominantly as a monomer in serum and as a dimer in seromucous secretions.

The major antibody in the serum is IgG and, as this is the best-understood antibody in terms of structure and function, we shall consider it first. The other antibody classes will be considered in relation to IgG.

The IgG molecule

In IgG, the Fab arms are linked to the Fc by an extended region of polypeptide chain known as the hinge. This region tends to be exposed and sensitive to attack by proteases that cleave the molecule into its distinct functional units arranged around the four-chain structure (Milestone 3.1). This structure is represented in greater detail in Figure 3.2a. The light chains exist in two forms, known as kappa (κ) and lambda (λ). In humans, κ chains are somewhat more prevalent than λ ; in mice, λ chains are rare. The heavy chains can also be grouped into different forms or subclasses, the number depending upon the species under consideration. In humans there are four **subclasses** having heavy chains labeled $\gamma 1$, $\gamma 2$, $\gamma 3$, and $\gamma 4$, which give rise to the IgG1, IgG2, IgG3, and IgG4 subclasses. In mice, there are again four subclasses denoted IgG1, IgG2a, IgG2b, and IgG3. The subclasses – particularly in humans – have very similar primary sequences, the greatest differences being observed in the hinge region. The existence of subclasses is an important feature as they show marked differences in their ability to trigger effector functions. In a single molecule, the two heavy chains are generally identical, as are the two light chains. The exception to the rule is provided by human IgG4, which can exchange heavy–light pairs between IgG4 molecules to produce hybrids. As the Fc parts of the exchanging molecules are identical, the net effect is Fab arm exchange to generate IgG4 antibodies having two distinct Fab arms and dual specificity.

The amino acid sequences of heavy and light chains of antibodies have revealed much about their structure and function. However, obtaining the sequences of antibodies is much more challenging than for many other proteins because the population of antibodies in an individual is so incredibly heterogeneous. The opportunity to do this first came from the study of **myeloma proteins**. In the human disease known as multiple myeloma, one cell making one particular individual antibody divides over and over again in the uncontrolled way a cancer cell does, without regard for the overall requirement of the host. The patient then possesses enormous numbers of identical cells derived as a clone from the original cell and they all synthesize the same immunoglobulin – the myeloma protein – which appears in the serum, sometimes in very high concentrations. By purification of myeloma proteins, preparations of a single antibody for sequencing and many other applications can be obtained. An alternative route to single or **monoclonal antibodies** arrived with the development of **hybridoma technology**. Here, fusing individual antibody-forming cells with a B-cell tumor produces a constantly dividing clone of cells dedicated to making the one antibody. Finally, **recombinant antibody technologies**, developed most recently, provide an excellent source of monoclonal antibodies.

Sequence comparison of monoclonal IgG proteins indicates that the carboxy-terminal (C-terminal) half of the light chain and roughly three-quarters of the heavy chain, again C-terminal, show little sequence variation between different IgG molecules. By contrast, the amino-terminal (N-terminal) regions of about 100 amino acid residues show considerable sequence variability in both chains. Within these variable regions there are relatively short sequences that show extreme variation and are designated hypervariable regions. There are three of these regions or “hot spots” on the light chain and three on the heavy chain. As the different IgGs in the comparison recognize different antigens, these **hypervariable regions** are expected to be associated with antigen recognition and indeed are often referred to as **complementarity determining regions (CDRs)**. The structural setting for the involvement of the hypervariable regions in antigen recognition and the genetic origins of the constant and variable regions will be discussed shortly.

The comparison of immunoglobulin sequences also reveals the organization of IgG into 12 homology regions or **domains**, each possessing an internal disulfide bond. The basic domain structure is central to an understanding of the relation between structure and function in the antibody molecule and will be taken up shortly. However, the structure in outline form is shown in Figure 3.2b,c. It can be seen that the light chain consists of two domains, one corresponding to the variable sequence region discussed earlier and designated the V_L (variable light) domain and the other corresponding to a constant region and designated the C_L (constant light) domain. The IgG heavy chain consists of four domains, the V_H and C_{H1} domains of the Fab arms being joined to the C_{H2} and C_{H3} domains of Fc via the hinge. Antigen binding occurs at the tips of the Fab arms and involves the V_L and V_H domains. Effector molecule binding occurs at the Fc stem and involves the C_{H2} and/or C_{H3} domains.

It is also clear (Figure 3.2b,c) that all of the domains except for C_{H2} are in close lateral or “sideways” association with another domain: a phenomenon described as domain pairing. The C_{H2} domains have two sugar chains interposed between them. The domains also exhibit weaker *cis* interactions with neighboring domains on the same polypeptide chain.

Human IgG1 is shown in Figure 3.2 as a Y-shaped conformation with the Fab arms roughly in the same plane as the Fc. This is the classical view of the antibody molecule that has adorned countless meetings ads and appears in many company logos. In reality, this is likely just one of many shapes that the IgG molecule can adopt as it is very **flexible**, as illustrated in Figure 3.3. It is believed that this flexibility may help IgG function. Thus Fab–Fab flexibility gives the antibody a “variable reach,” allowing it to grasp antigenic determinants of different spacings on a foreign cell surface or to form intricate immune complexes with a toxin (imagine a Y to T shape change). Fc–Fab flexibility may help antibodies in different environments, on foreign cells for example, to interact productively with common effector molecules. Figure 3.4 shows the complete structure of a human IgG1 antibody molecule determined by crystallography. The structure is quite removed from the classical

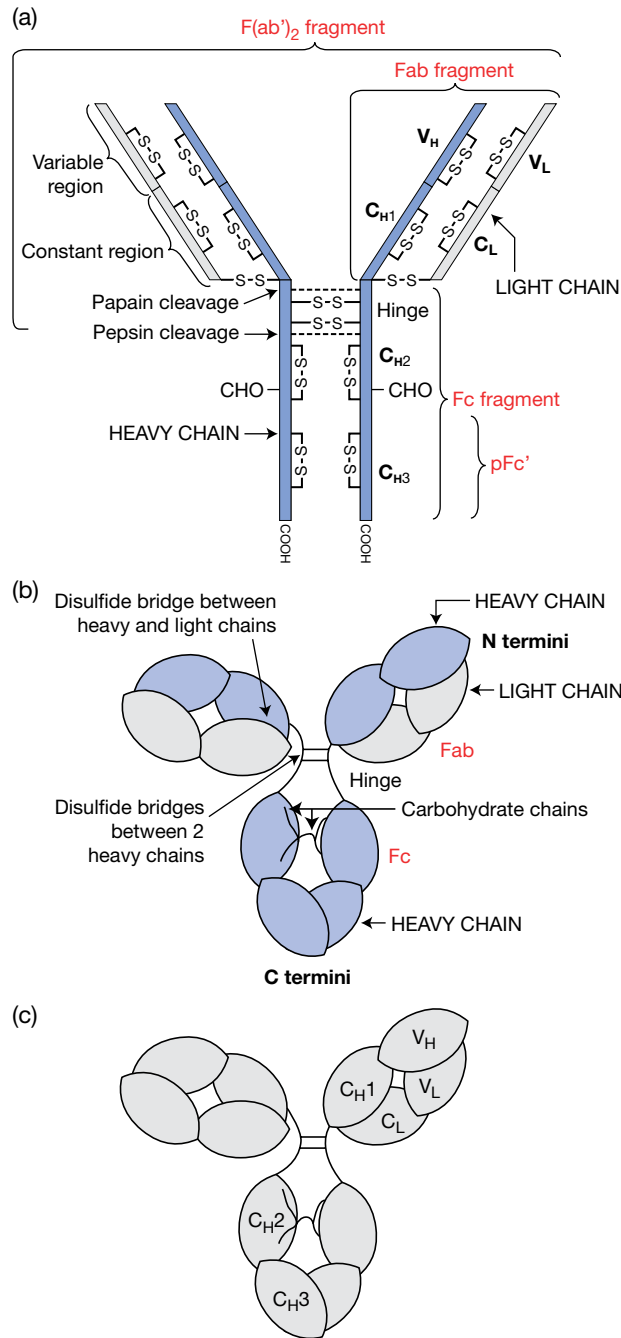


Figure 3.2 The four-chain structure of IgG (human IgG1). (a) Linear representation. Disulfide bridges link the two heavy chains and the light and heavy chains. A regular arrangement of intrachain disulfide bonds is also found. Fragments generated by proteolytic cleavage at the indicated sites are represented. (b) Domain representation. Each heavy chain (shaded dark) is folded into two domains in the Fab arms, forms a region of extended polypeptide chain in the hinge and is then folded into two domains in the Fc region. The light chain forms two domains associated only with a Fab arm. Domain pairing leads to close interaction of heavy and light chains in the Fab arms supplemented by a disulfide bridge. The two heavy chains are disulfide bridged in the hinge (the number of bridges depending on IgG subclass) and are in close domain-paired interaction at their C-termini. (c) Domain nomenclature. The heavy chain is composed of V_H, C_{H1}, C_{H2}, and C_{H3} domains. The light chain is composed of V_L and C_L domains. All the domains are paired except for the C_{H2} domains, which have two branched N-linked carbohydrate chains interposed between them. Each domain has a molecular weight of approximately 12 000, leading to a molecular weight of ~50 000 for Fc and Fab and 150 000 for the whole IgG molecule. Antigen recognition involves residues from the V_H and V_L domains, complement triggering the C_{H2} domain, leukocyte Fc receptor binding the C_{H2} domain, and the neonatal Fc receptor the C_{H2} and C_{H3} domains (see text). (Source: Calabi F. and Neuberger M.S. (1987) *New Comprehensive Biochemistry*, Vol. 17: *Molecular Genetics of Immunoglobulin*. Reproduced with permission of Elsevier.)

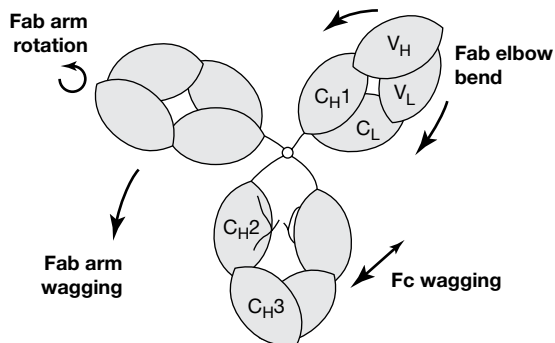


Figure 3.3 Modes of flexibility in the IgG (human IgG1) molecule. These modes have been described from electron microscopic studies (see Figure 3.10) and biophysical techniques in solution. Flexibility in structure probably facilitates flexibility in antigen recognition and effector function triggering.

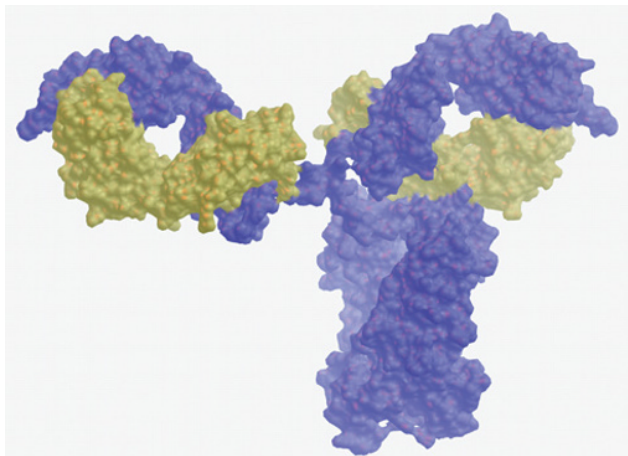


Figure 3.4 The structure of a human IgG molecule. The heavy chains are shown in purple and the light chains in brown. Relative to the classical cartoon of an IgG molecule as a Y shape, this “snapshot” of the molecule finds the Fc (bottom) “side on” to the viewer and much closer to one Fab arm than the other. (Source: Erica Ollmann Saphire. Reproduced with permission.)

symmetrical Y shape. The Fc is closer to one Fab arm than another and is rotated relative to the Fab arms. This is simply a “snapshot” of one of the many conformations that the antibody can adopt by virtue of its flexibility.

The structural organization of IgG into domains is clearly evident from Figure 3.2–Figure 3.4. Each of these domains has a common pattern of polypeptide chain folding (Figure 3.5). This pattern, the “immunoglobulin fold,” consists of two twisted stacked β -sheets enclosing an internal volume of tightly packed hydrophobic residues. The arrangement is stabilized by an internal disulfide bond linking the two sheets in a central position (this internal bond is seen in Figure 3.2a). In a constant Ig domain, one sheet has four and the other three

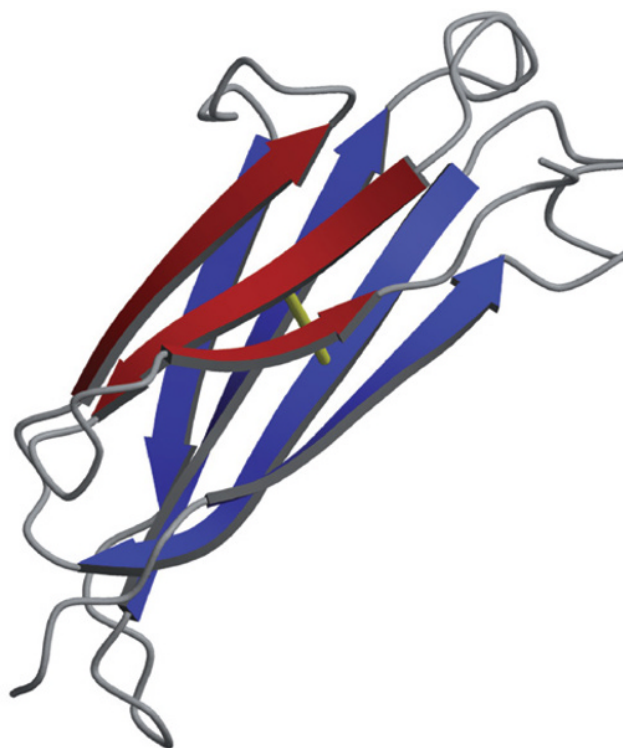


Figure 3.5 The immunoglobulin fold (constant domain). An anti-parallel three-stranded β -sheet (red) interacts with a four-stranded sheet (blue). The arrangement is stabilized by a disulfide bond linking the two sheets. The β -strands are connected by helices, turns, and other structures. A similar overall core structure is seen in all Ig-like domains but with some modifications such as extra β -strands or changes in how the edge strands pair with the β -sheets.

anti-parallel β -strands. These strands are joined by bends or loops that generally show little secondary structure. Residues involved in the β -sheets tend to be conserved while there is a greater diversity of residues in the loops. The chain folding illustrated in Figure 3.5 is for a constant domain. The β -sheets of the variable domain are more distorted than those of the constant domain and the variable domain possesses an extra loop.

Structure of Fab fragment

The Fab fragment pairs V_H and V_L domains and C_H1 and C_L domains (Figure 3.6). The V_H and V_L domains are paired by contact between the two respective three-strand β -sheet layers (red in Figure 3.5) whereas the C_H1 and C_L domains are paired via the two four-strand layers (blue in Figure 3.5). The interacting faces of the domains are predominantly hydrophobic and the driving force for domain pairing is thus the removal of these residues from the aqueous environment. The arrangement is further stabilized by a disulfide bond between C_H1 and C_L domains.

In contrast to the “sideways” interactions, the “longwise” or *cis* interactions between V_H and C_H1 domains and between V_L and C_L domains are very limited and allow bending about the

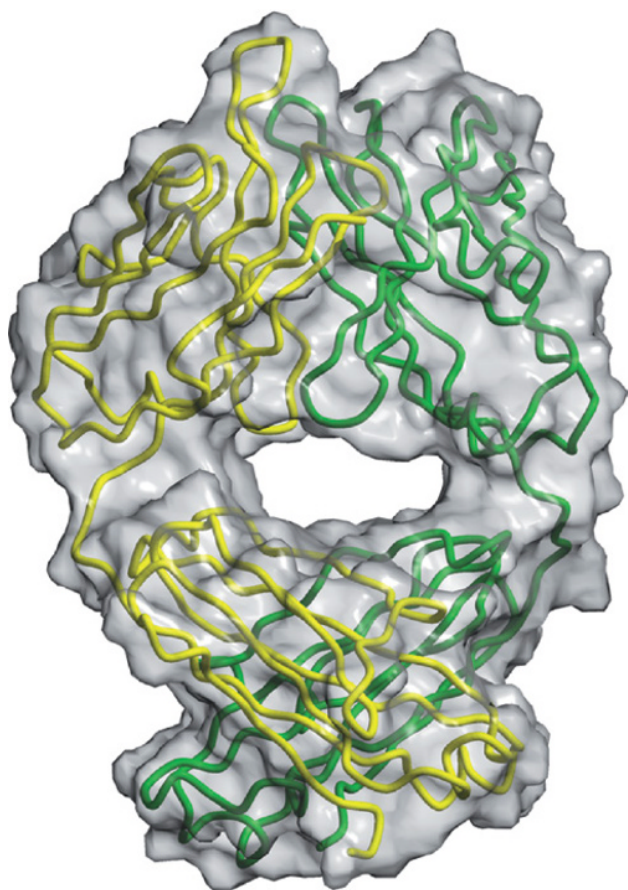


Figure 3.6 The structure of Fab. The heavy chain is shown in green and the light chain in yellow. The V_H and V_L domains (top) are paired by contact between their five-strand faces and the C_H1 and C_L domains between the four-strand faces. (Source: Robyn Stanfield. Reproduced with permission.)

“elbows” between these domains. Elbow angles seen in crystal structures vary between about 117° and 249° .

The antibody combining site

Comparison of antibody sequence and structural data shows how antibodies are able to recognize an enormously diverse range of molecules. Sequence data show that the variable domains have six hypervariable regions that display great variation in amino acids between different antibody molecules (Figure 3.7). Structural data of antibody–antigen complexes reveal that these hypervariable regions, or complementarity determining regions, come together in 3D space to form the antigen-binding site, often also termed the *antibody combining site* (Figure 3.8).

Structure of Fc

For the Fc of IgG (Figure 3.9), the two C_H3 domains are classically paired, whereas the two C_H2 domains show no close interaction, but have interposed between them two branched *N*-linked carbohydrate chains that have limited contact with

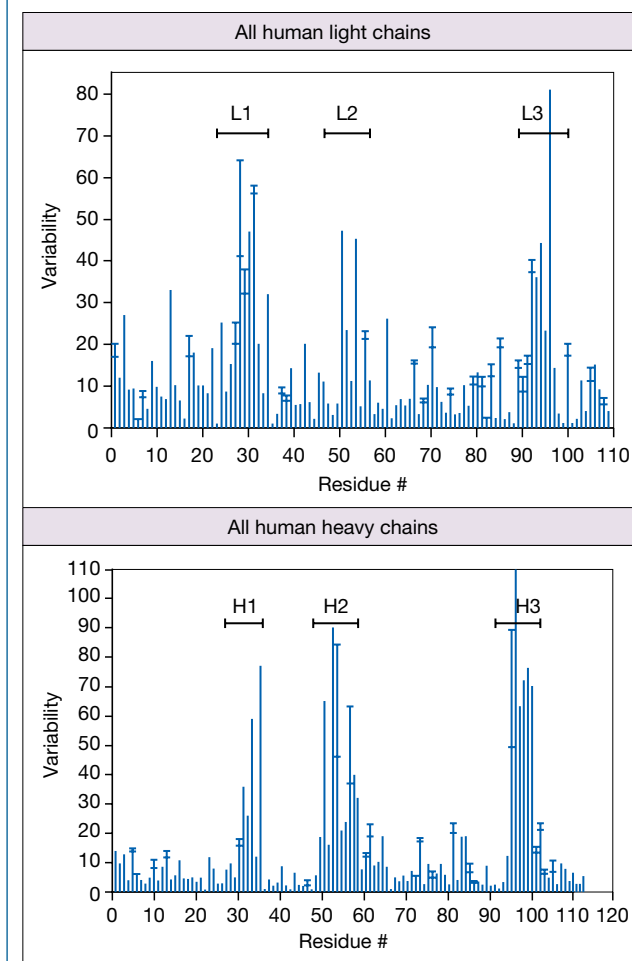


Figure 3.7 Amino acid variability in the V domains of human Ig heavy and light chains. Variability, for a given position, is defined as the ratio of the number of different residues found at that position compared to the frequency of the most common amino acid. The complementarity determining regions (CDRs) are apparent as peaks in the plot and the frameworks as intervening regions of low variability. (Source: Dr. E.A. Kabat. Reproduced with permission.)

one another. The carbohydrate chains are very heterogeneous. The C_H2 domains contain the binding sites for several important effector molecules, complement C1q and Fc receptors in particular, as shown. The neonatal Fc receptor, which is important in binding to IgG and maintaining its long half-life in serum, binds to a site formed between C_H2 and C_H3 domains. Protein A, much used in purifying IgGs, also binds to this site.

The hinge region and IgG subclasses

The term “*hinge*” arose from electron micrographs of rabbit IgG, which showed Fab arms assuming different angles relative to one another from nearly 0° (acute Y-shaped) to 180° (T-shaped). The Fab was specific for a small chemical group, dinitrophenyl (DNP), that could be attached to either end of a hydrocarbon chain. As shown in Figure 3.10 and

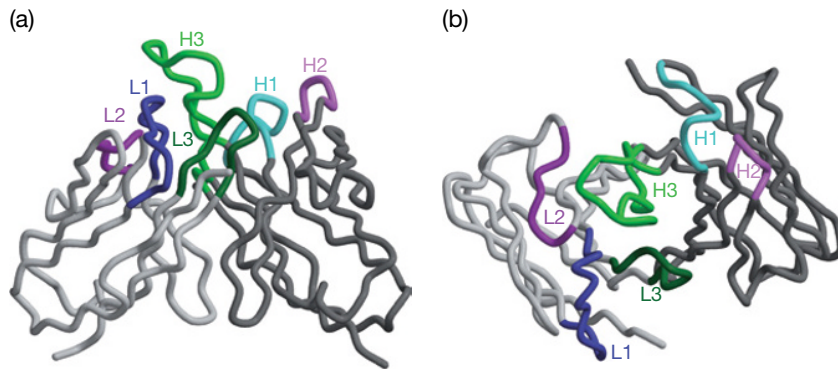


Figure 3.8 The proximity of complementarity determining regions (CDRs or variable loops) at the tip of the Fab arms creates the antibody combining site. The V_H and V_L domains are shown from the side (a) and from above (b). The six CDRs (see Figure 3.7) are numbered 1–3 as belonging to the heavy (H) or light (L) chain. (Source: Robyn Stanfield. Reproduced with permission.)

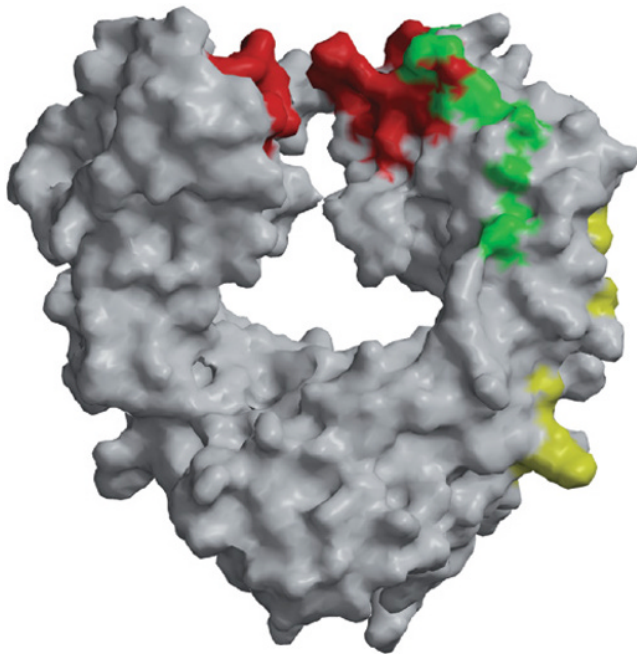


Figure 3.9 Structure of Fc of human IgG. The C_{H3} domains (bottom) are paired. The C_{H2} domains are not and have two carbohydrate chains filling some of the space between them. Binding sites for the leukocyte $Fc\gamma RIII$ receptor (red), complement C1q (green), and neonatal Fc receptor FcRn (yellow) are shown. The $Fc\gamma RIII$ and FcRn sites were determined in crystallographic studies (Sondermann P. *et al.* (2000) *Nature* 406, 267; Martin W.L. *et al.* (2001) *Molecular Cell* 7, 867) and the C1q site by mutation analysis (Idusogie E.E. *et al.* (2000) *Journal of Immunology* 164, 4178). (Source: Robyn Stanfield. Reproduced with permission.)

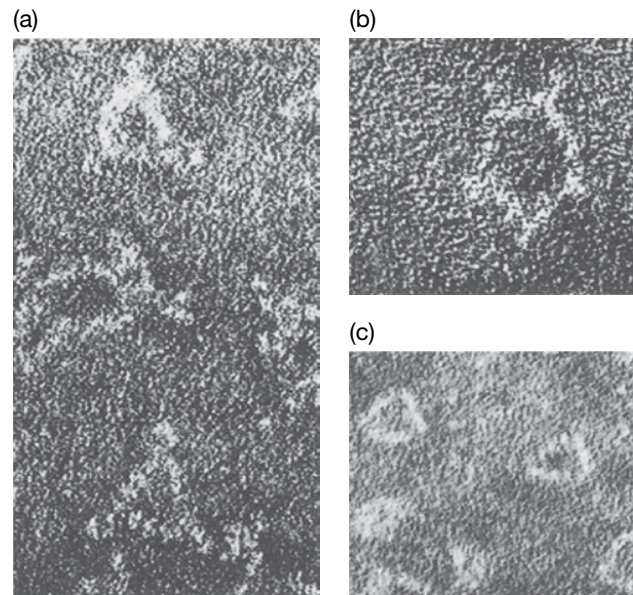


Figure 3.10 (a,b) Electron micrograph ($\times 1\,000\,000$) of complexes formed on mixing the divalent dinitrophenyl (DNP) hapten with rabbit anti-DNP antibodies. The “negative stain” phosphotungstic acid is an electron-dense solution that penetrates into the spaces between the protein molecules. Thus the protein stands out as a “light” structure in the electron beam. The hapten links together the Y-shaped antibody molecules to form trimers (a) and pentamers (b). The flexibility of the molecule at the hinge region is evident from the variation in angle of the arms of the “Y.” (c) As in (a), but the trimers were formed using the $F(ab')_2$ antibody fragment from which the Fc structures have been digested by pepsin ($\times 500\,000$). The trimers can be seen to lack the Fc projections at each corner evident in (a). (Source: Valentine R.C. and Green N.M. (1967) *Journal of Molecular Biology* 27, 615. Reproduced with permission of Elsevier.)

Figure 3.11, different shapes were observed as the Fab arms linked together the bivalent antigen molecule using different Fab–Fab arm angles. Other biophysical techniques have demonstrated hinge flexibility in solution. The function of this flexibility has generally been seen as allowing divalent recognition of variably spaced antigenic determinants. The IgG class of antibody in humans exists as four subclasses and the biggest difference between the subclasses is in the nature and length of the hinge. IgG1 has been shown above. IgG3 has a hinge that, if fully extended, would be about twice the length of the Fc, thereby potentially placing the Fab arms far removed from the Fc. In contrast, IgG2 and IgG4 have short, compact hinges that probably lead to close approach of Fab and Fc. Interestingly, IgG1 and IgG3 are generally superior at

mediating effector functions such as complement activation and ADCC relative to IgG2 and IgG4.

The structure and function of the immunoglobulin classes

The immunoglobulin classes (Table 3.1) fulfill different roles in immune defense and this can be correlated with differences in their structures as organized around the four-chain Ig domain arrangement (Figure 3.12). **IgG** is monomeric and the major antibody in serum and nonmucosal tissues, where it inactivates pathogens directly and through interaction with effector triggering molecules, such as complement and Fc receptors. **IgM** is pentameric, is found in serum, and is highly efficient at complement triggering. A monomeric form of IgM with a membrane-tethering sequence is the major antibody receptor used by B-lymphocytes to recognize antigen (see Figure 2.11). IgM differs from IgG in having an extra pair of constant domains instead of the hinge region. **IgA** exists in three soluble forms. Monomeric and small amounts of dimeric IgA (formed from two monomers linked by an extra polypeptide called J chain) are found in the serum where they can help link pathogens to effector cells via Fc receptors specific for IgA. Secretory IgA is formed of dimeric IgA and an extra protein known as secretory component (SC) and is crucial in protecting the mucosal surfaces of the body against attack by microorganisms. IgA exists as two subclasses in humans. IgA2 has a much shorter hinge than IgA1 and is more resistant to attack by bacterially secreted proteases. **IgE** is a monomeric antibody typically found at very low concentrations in serum. In fact, most IgE is probably bound to IgE Fc receptors on mast cells. Antigen binding to IgE cross-links IgE Fc receptors and triggers an acute inflammatory reaction that can assist in immune defense. This can also lead to unwanted allergic symptoms for certain antigens (allergens). IgE, like IgM, has an extra pair of constant domains instead of the hinge region. Finally, **IgD** is an

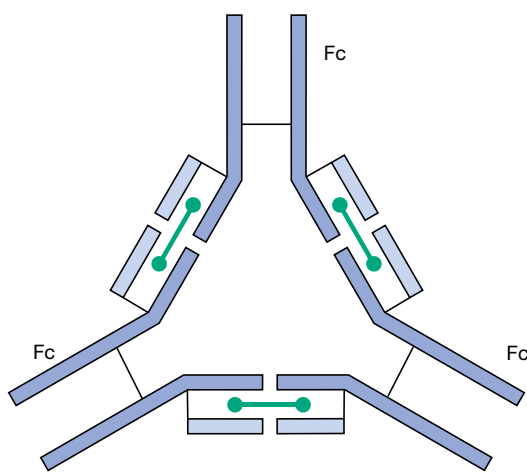


Figure 3.11 Three dinitrophenyl (DNP) antibody molecules held together as a trimer by the divalent antigen (green bar). Compare Figure 3.10a. When the Fc fragments are first removed by pepsin, the corner pieces are no longer visible (Figure 3.10c).

Table 3.1 The human immunoglobulins.

Class (heavy chain designation)	Human subclasses	Principal molecular forms	Polypeptides	Primary location	Complement activation (pathway)
IgG (γ)	IgG1 IgG2 IgG3 IgG4	Monomer	γ 2, L2	Serum (~12 mg/mL), tissues	IgG3 > IgG1 >> IgG2 >> IgG4 (classical)
IgA (α)	IgA1 IgA2	Monomer Dimer Secretory	α 2, L2 (α 2, L2) ₂ , J (α 2, L2) ₂ , J, SC	Serum (~3 mg/mL): 90% monomer, 10% dimer Seromucous secretions, milk, colostrum, tears	Yes (mannose-binding lectin)
IgM (μ)		Pentamer	(μ 2, L2) ₅ , J	Serum (~1.5 mg/mL)	Yes (classical)
IgE (ϵ)		Monomer	ϵ 2, L2	Serum (0.05 μ g/mL)	No
IgD (δ)		Monomer	δ 2, L2	Serum (30 μ g/mL)	No

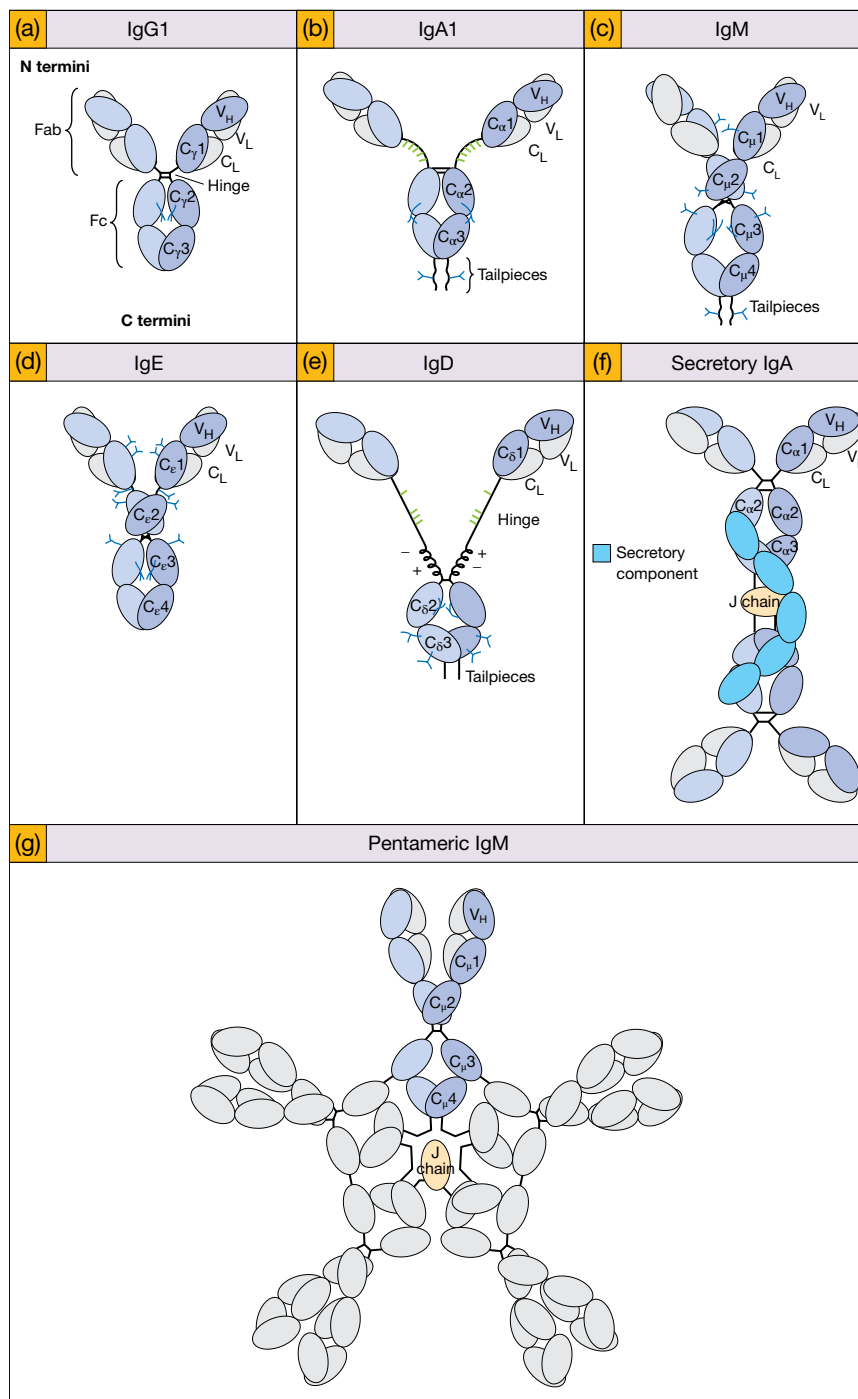
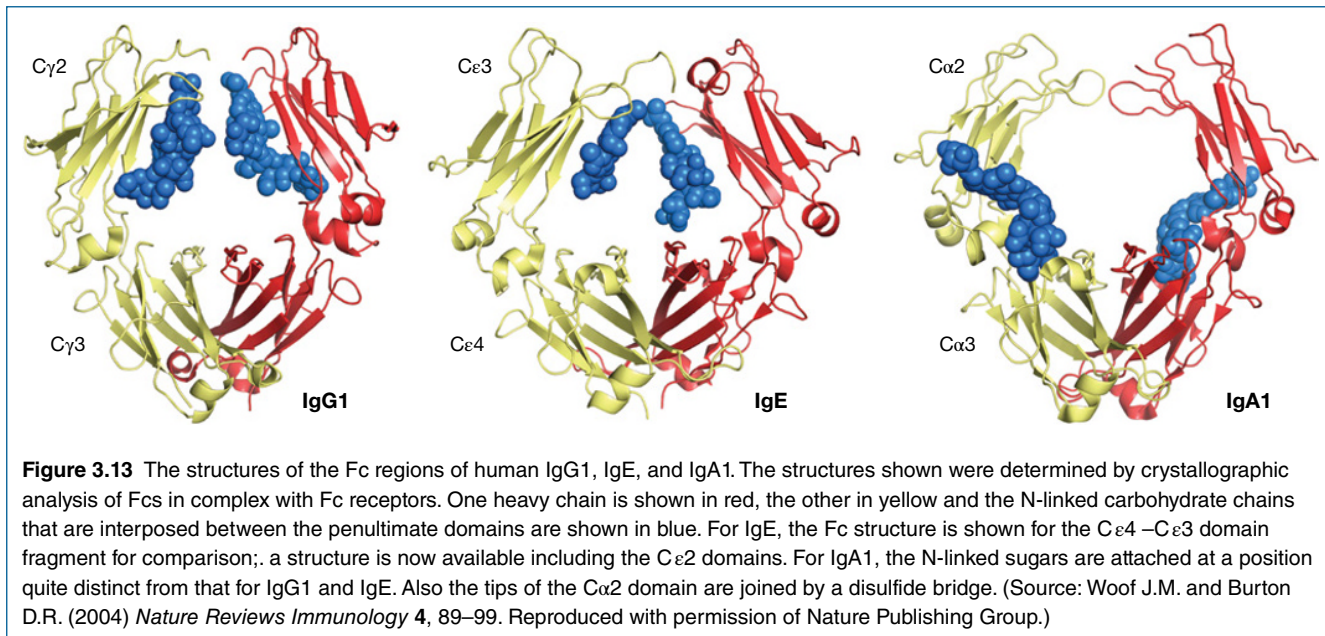


Figure 3.12 Schematic structures of the antibody classes. The two heavy chains are shown in dark and pale blue (two colors to highlight chain pairing; the chains are identical) and the light chains in gray. The *N*-linked carbohydrate chains (branched structures) are shown in blue and *O*-linked carbohydrates (linear structures) in green. The heavy chain domains are designated according to the class of the heavy chain (e.g., $C_{\gamma 2}$ for the $C_{\gamma 2}$ domain of IgG, etc.). For IgG, IgA, and IgD, the Fc is connected to the Fab arms via a hinge region; for IgM and IgE an extra pair of domains replaces the hinge. IgA, IgM, and IgD have tailpieces at the C-termini of the heavy chains. IgA occurs in monomer and dimer forms. IgM occurs as a pentamer. (a) IgG1. The other human IgG subclasses (and IgGs of most other species) have this same basic structure but differ particularly in the nature and length of the hinge. (b) IgA1. The structure resembles IgG1 but with a relatively long hinge bearing *O*-linked sugar chains. The Fc also shows some differences from IgG1 (see Figure 3.13). In IgA2, the hinge is very short and, in the predominant allotype, the light chains are disulfide linked not to the heavy chain but to one another. (c) IgM monomeric unit. This representation relies greatly on comparison of the amino acid sequences of μ and γ heavy chains. (d) IgE. The molecule is similar to the monomeric unit of IgM. (e) IgD. The hinge can be divided into a region rich in charge (possibly helical) and one rich in *O*-linked sugars. The structure of the hinge may be much less extended in solution than represented schematically here. It is, however, very sensitive to proteolytic attack so that serum IgD is unstable. Mouse IgD has a structure very different to that of human IgD, in contrast to the general similarity in structures for human and mouse Igs. (f) Secretory IgA (see also Figure 3.19). (g) Pentameric IgM. The molecule is represented as a planar star shape. One monomer unit is shown shaded as in (c). A minority of IgM units can also form a hexamer. For clarity the carbohydrate structures have been omitted in (f) and (g). The Fab arms can likely rotate out of the plane about their two-fold axis (see also Figure 3.14).



antibody primarily found on the surface of B-cells as an antigen receptor together with IgM, where it likely serves in the control of lymphocyte activation and suppression. There is also some evidence that free IgD may help protect against microbes in the human upper respiratory tract. IgD is monomeric and has a long hinge region.

The structures of the Fc regions of human IgA1 and IgE have been determined and are compared with IgG1 in Figure 3.13. In all three cases, the penultimate domains are unpaired and have carbohydrate chains interposed between them.

Antibodies and complement

The clustering together of IgG molecules, typically on the surface of a pathogen such as a bacterium, leads to the binding of the complement C1 molecule via the hexavalent C1q subcomponent (see Figure 2.2). This triggers the classical pathway of complement and a number of processes that can lead to pathogen elimination. Recently, it has been proposed that the most favorable clustered arrangement of antibodies on an antigen surface for complement triggering may also be hexameric, thereby matching the symmetry of C1q. The subclasses of IgG trigger with different efficiencies. IgG1 and IgG3 trigger best; IgG2 is only triggered by antigens at high density (e.g., carbohydrate antigens on a bacterium); and IgG4 does not trigger.

IgM triggers by a different mechanism. It is already “clustered” (pentameric) but occurs in an inactive form. Binding to multivalent antigen appears to alter the conformation of the IgM molecule to expose binding sites that allow C1q to bind and the classical pathway of complement to be triggered. Electron microscopy studies suggest the conformational change is a “star” to “staple” transition, in which the Fab arms move out of the plane of the Fc regions (Figure 3.14). IgM antibodies tend to be of low affinity as measured in a univalent interaction

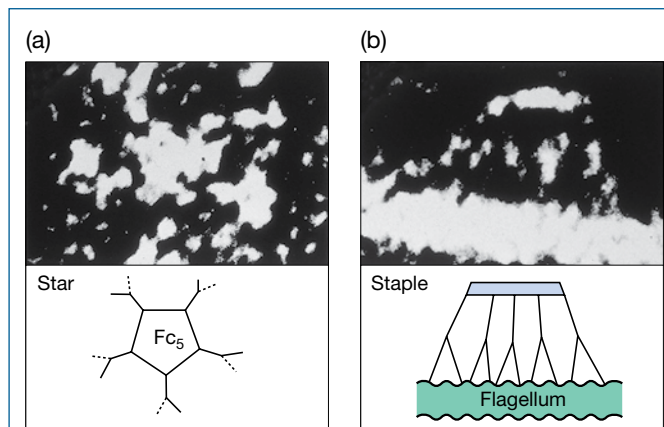


Figure 3.14 Structural changes in IgM associated with complement activation. (a) The “star” conformation. Electron micrograph of an uncomplexed IgM protein shows a “star-shaped” conformation (see Figure 3.12 g). (b) The “staple” conformation. Electron micrograph of a specific sheep IgM bound to a *Salmonella paratyphi* flagellum as antigen suggests that the five F(ab')₂ units and C μ 2 domains have been dislocated relative to the plane of the Fcs to produce a “staple” or “crab-like” conformation. Complement C1 is activated on binding to antigen-complexed IgM (staple), but interacts only very weakly, yielding no significant activation, with free IgM (star), implying that the dislocation process plays an important role in complement activation. It is suggested that movement of the Fabs exposes a C1q-binding site on the C μ 3 domains of IgM. This is supported by observations that an Fc₅ molecule, obtained by papain digestion of IgM, can activate complement directly in the absence of antigen. Electron micrographs are negatively stained preparations of magnification $\times 2 \times 10^6$, i.e., 1 mm represents 0.5 nm. (Source: Dr. A. Feinstein and Dr. E.A. Munn. Reproduced with permission.)

(e.g., binding of IgM to a soluble monomeric molecule or binding of an isolated Fab from an IgM to an antigen). However, their functional affinity (avidity) can be enhanced by multivalent antibody–antigen interaction and it is precisely under such circumstances that they are most effective at activating complement.



Antibodies and human leukocyte Fc receptors

Specific human Fc receptors have been described for IgG, IgA, and IgE (Table 3.2). The receptors differ in their specificities for antibody classes and subclasses, their affinities for different association states of antibodies (monomer versus associated antigen-complexed antibody), their distributions on different leukocyte cell types, and their cellular signaling mechanisms. Most of the leukocyte Fc receptors are structurally related, having evolved as members of the Ig gene superfamily. Each comprises a unique ligand-binding chain (α chain), which is often complexed via its transmembrane region with a dimer of the common Fc γ chain. The latter plays a key role in the **signaling functions** of many of the receptors. Fc γ chains carry immunoreceptor tyrosine-based activation motifs (ITAMs) in their cytoplasmic regions, critical for initiation of activatory signals. Some receptor α chains carry their own ITAMs in their cytoplasmic regions, whereas others bear the immunoreceptor tyrosine-based inhibitory motifs (ITIMs).

For IgG, three different classes of human leukocyte Fc γ Rs have been characterized, most with several variant forms. In addition, the neonatal Fc receptor FcRn also binds IgG and will be dealt with later. **Fc γ RI** (CD64) is characterized by its high affinity for monomeric IgG. It is also unusual in that it has three extracellular Ig-like domains in its ligand-binding chain, while all other Fc receptors have two. Fc γ RI is constitutively expressed on monocytes, macrophages and dendritic cells, and is induced on neutrophils and eosinophils following their activation by IFN γ and G-CSF (granulocyte colony-stimulating factor). Conversely, Fc γ RI can be downregulated in response to IL-4 and IL-13. Structurally, it consists of an IgG-binding α chain and a γ chain homodimer containing ITAMs. It binds monomeric IgG avidly to the surface of the cell, thus sensitizing it for subsequent encounter with antigen. Its main roles are probably in facilitating phagocytosis, in antigen presentation, and in mediating extracellular killing of target cells coated with IgG antibody, a process referred to as antibody-dependent cellular cytotoxicity (ADCC).

Fc γ RII (CD32) binds very weakly to monomeric IgG but with considerably enhanced affinity to associated IgG, as in immune complexes or on an antibody-coated target cell. Therefore, cells bearing Fc γ RII are able to bind antibody-coated targets in the presence of high serum concentrations of monomeric IgG. Unlike the single isoform of Fc γ RI, there are multiple expressed isoforms of Fc γ RII that collectively are present on the surface of most types of leukocyte (Table 3.2). The binding of IgG complexes to Fc γ RII triggers phagocytic cells and may provoke thrombosis through their reaction with

platelets. Fc γ RIIa are activating receptors expressed on phagocytes that mediate phagocytosis and ADCC. In contrast, Fc γ RIIb are inhibitory receptors that have cytoplasmic domains containing ITIMs and their occupation leads to downregulation of cellular responsiveness. Fc γ RIIb occurs as two isoforms generated by alternative splicing. Fc γ RIIb1 present on B-cells cross-links B-cell receptors (BCR) and transmits an inhibitory signal to inactivate the B-cell with a negative-feedback effect on antibody production. Fc γ RIIb2 is expressed on phagocytes, where it efficiently mediates endocytosis, leading to antigen presentation.

Fc γ RIII (CD16) also binds rather poorly to monomer IgG but has low to medium affinity for aggregated IgG. The two Fc γ RIII genes encode the isoforms Fc γ RIIIa and Fc γ RIIIb that have a medium and low affinity for IgG, respectively. Fc γ RIIIa is found on most types of leukocyte, whereas Fc γ RIIIb is restricted mainly to neutrophils and is unique among the Fc receptors in being attached to the cell membrane by a glycosylphosphatidylinositol (GPI) anchor rather than a transmembrane segment. Fc γ RIIIa is known to be associated with the γ chain signaling dimer on monocytes and macrophages, and with either ζ and/or γ chain signaling molecules in NK cells, and its expression is upregulated by transforming growth factor β (TGF β) and downregulated by IL-4. With respect to their functions, Fc γ RIIIa is largely responsible for mediating ADCC by NK cells and the clearance of immune complexes from the circulation by macrophages. For example, the clearance of IgG-coated erythrocytes from the blood of chimpanzees was essentially inhibited by the monovalent Fab fragment of a monoclonal anti-Fc γ RIII. Fc γ RIIIb cross-linking stimulates the production of superoxide by neutrophils.

For IgE, two different Fc γ Rs have been described. The binding of IgE to its receptor **Fc ϵ RI** is characterized by the remarkably high affinity of the interaction, reflecting a very slow dissociation rate (the half-life of the complex is \sim 20 hours). Fc ϵ RI is a complex comprising a ligand-binding α chain structurally related to those of Fc γ R, a β chain, and the Fc γ chain dimer. Contact with antigen leads to degranulation of the mast cells with release of preformed vasoactive amines and cytokines, and the synthesis of a variety of inflammatory mediators derived from arachidonic acid (see Figure 1.14). This process is responsible for the symptoms of hay fever and of extrinsic asthma when patients with atopic allergy come into contact with the allergen (e.g., grass pollen). The main physiological role of IgE would appear to be protection of anatomical sites susceptible to trauma and pathogen entry by local recruitment of plasma factors and effector cells through the **triggering of an acute inflammatory reaction**. Infectious agents penetrating the IgA defenses would combine with specific IgE on the mast cell surface and trigger the release of vasoactive agents and factors chemotactic for polymorphs, so leading to an influx of plasma IgG, complement, neutrophils, and eosinophils. In such a context, the ability of eosinophils to damage IgG-coated helminths and the generous IgE response to such parasites would constitute an effective defense.

Table 3.2 Human leukocyte Fc receptors.

	FcγRI (CD64)	FcγRIII (CD32)	FcγRIII (CD16)	FcϵRI	FcϵRIII (CD23)	FcαRI (CD89)
MW (kDa)	50–70	40	50–80	45–65	45–50	50–70
Major isoforms expressed	Fc γ R1a	Fc γ R1a / Fc γ R1b	Fc γ R1a / Fc γ R1c	Fc ϵ RI	Fc ϵ R IIa	Fc α R1a
Allotypes	H131	R131	V158 F158	NA1 NA2	NA1 NA2	
Specificity for human Ig*	IgG1 = 3 > 4 IgG2 does not bind	IgG1 > 3 > 2 > 4 3 > 4 > 2	IgG1 = 3 > 2 IgG4 does not bind	IgG1 = 3 > 2 IgG4 does not bind	IgG3 > 1 IgG3 > 1 IgG3 > 1	Serum IgA1 = 2, SIgA1 = SIgA2
Affinity for monomer Ig (M ⁻¹)	High (10 ⁷ –10 ⁸)	Low (<10 ⁷)	Lowest affinities	Lowest affinities	High for IgG3	Medium (10 ⁷)
Signaling motif	γ chain ITAM	α chain ITAM	α chain ITIM	α chain ITAM	γ chain ITAM	γ chain ITAM
Cellular distribution	Monocytes, macrophages, DC, neutrophils (IFN γ stim), eosinophils (IFN γ stim)	Monocytes, macrophages, neutrophils, platelets, Langerhans cells	Monocytes, macrophages, B-cells	Monocytes, macrophages, neutrophils, B-cells	Monocytes, macrophages, eosinophils, mast cells, basophils, Langerhans cells, activated monocytes	Neutrophils, monocytes, some macrophages, eosinophils, Kupffer cells, some DC

GPI, glycosylphosphatidylinositol; ITAM, immunoreceptor tyrosine-based activation motif; ITIM, immunoreceptor tyrosine-based inhibitory motif.

* Relative affinities of various ligands for each receptor have been determined on recombinant FcR ectodomains (Bruhns *et al.*, 2009, *Blood* **113**, 3716).
Data sources: Woof J.M. and Burton D.R. (2004) *Nature Reviews Immunology* **4**, 89 and Bruhns P., *et al.* (2009) *Blood* **113**, 3716.

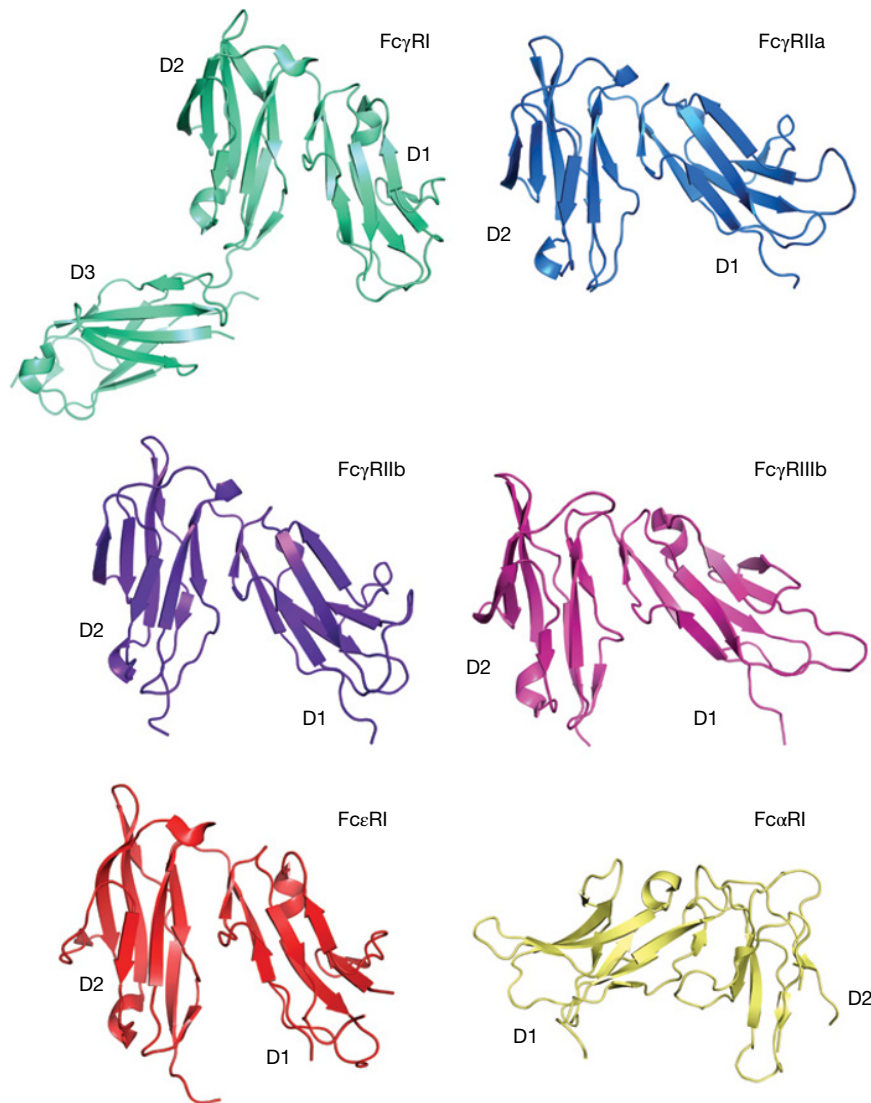


Figure 3.15 Structures of human leukocyte Fc receptors. In each case, a similar view of the receptor is shown. D1, membrane distal; D2, membrane-proximal domain, except for Fc γ RI for which D3 is the proximal domain and Fc α RI for which D2 is membrane proximal. For the Fc γ Rs and Fc ϵ RI, the Fc-binding site is present at the “top” of the D2 domain, whereas for Fc α RI the Fc-interaction site is present at the top of the D1 domain. (Source: Jenny Woof and Christina Corbaci. Reproduced with permission.)

The low-affinity IgE receptor **Fc ϵ RII** (CD23) is a C-type (calcium-dependent) lectin. It is present on many different types of hematopoietic cells (Table 3.2). Its primary function appears to be in the regulation of IgE synthesis by B-cells, with a stimulatory role at low concentrations of IgE and an inhibitory role at high concentrations. It can also facilitate phagocytosis of IgE-opsonized antigens.

For IgA, **Fc α RI** (CD89), is the most well-characterized Fc receptor. Its ligand-binding α chain is structurally related to those of the Fc γ Rs and Fc ϵ RI but represents a more distantly related member of the family. In fact, it shares closer homology with members of a family including NK cell immunoglobulin-like receptors (KIRs), leukocyte Ig-like receptors (LIR/LILR/

ILTs) and the platelet-specific collagen receptor (GPVI). Fc α RI is present on monocytes, macrophages, neutrophils, eosinophils, and Kupffer cells. The cross-linking of Fc α RI by antigen can activate endocytosis, phagocytosis, inflammatory mediator release, and ADCC. Expression of Fc α RI on monocytes is strongly upregulated by bacterial polysaccharide.

Crystal structures are available for Fc γ RIa, Fc γ RIIa, Fc γ RIIb, Fc γ RIIb, Fc ϵ RI, and Fc α RI (Figure 3.15). In most cases, the structures represent the two Ig-like extracellular domains of the receptor α chain, termed D1 (N-terminal, membrane distal) and D2 (C-terminal, membrane proximal). No structure is yet available for the cytoplasmic portions of any receptor. The equivalent extracellular regions of Fc γ RI,

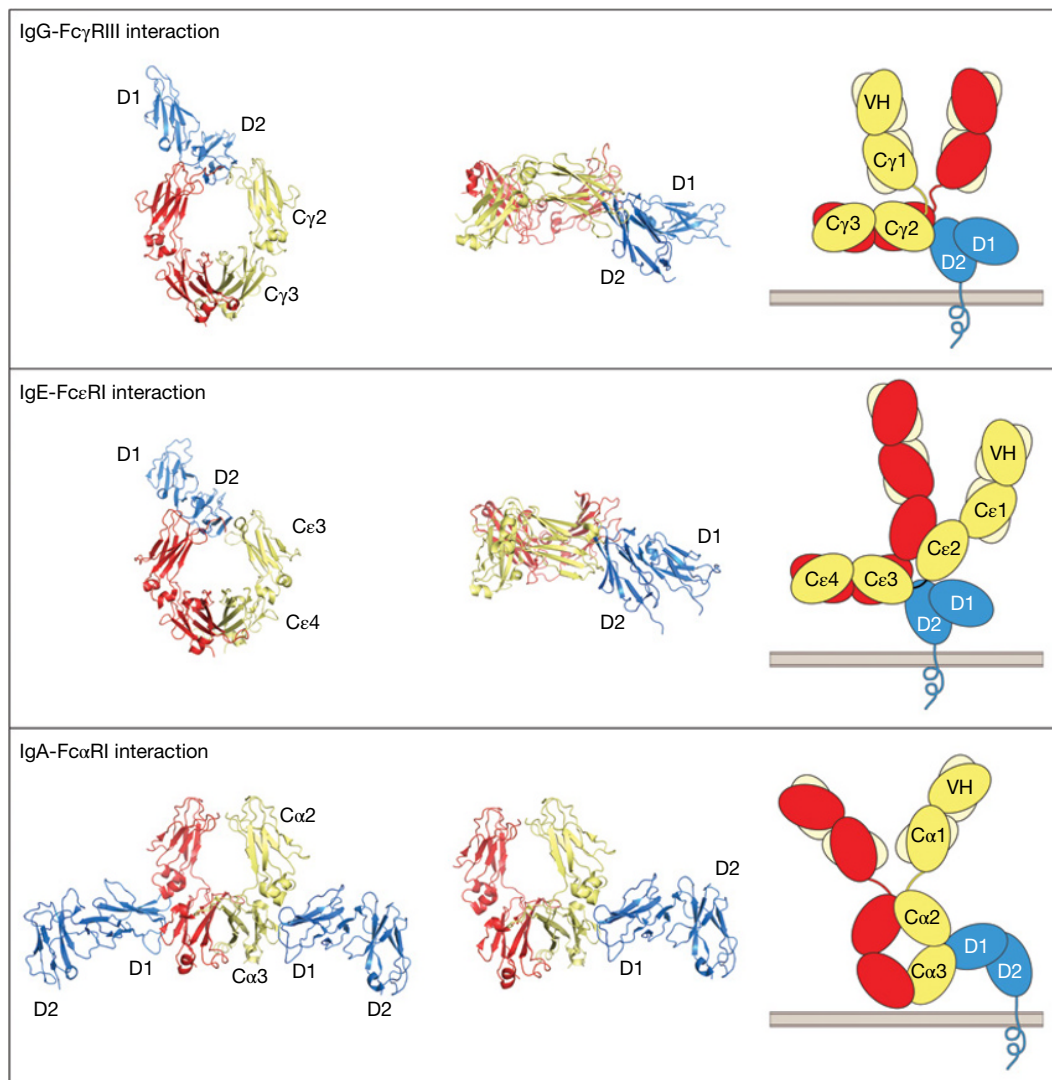


Figure 3.16 Structures of antibody–leukocyte Fc receptor interactions. The left-hand side and middle columns show views of the crystal structures of the complexes of the FcRs with their respective Fc ligands. The extracellular domains of the receptors are shown in blue; one heavy chain of each Fc region is shown in red and the other in dark yellow. In the left-hand column, each Fc region is viewed face on. The similarity between the IgG–Fc γ RIII and IgE–Fc ϵ RI interactions is striking, whereas the IgA–Fc α RI interaction is quite different in terms of the sites involved and the stoichiometry. The middle column shows a view where the D2 domains of each of the receptors are positioned so that their C-termini face downwards. Here the Fc regions of IgG and IgE are seen in a horizontal position from the side. For the IgA interaction only one receptor molecule is shown. The right-hand column shows a schematic representation of the receptors and their intact ligands from the same viewpoint as the images in the middle column. Light chains are shown in pale yellow. The necessity for dislocation of IgG and IgE to allow positioning of the Fab tips away from the receptor-bearing cell surface is apparent. (Source: Jenny Woof and Christina Corbaci. Reproduced with permission.)

Fc γ RIIa/b, Fc γ RIII, and Fc ϵ RI are seen to share the same overall structure. Despite the basic sequence similarity between Fc α RI and these receptors, the IgA receptor turns out to have a strikingly different structure. Although the two individual domains of the Fc α RI extracellular portion fold up in a similar manner to those of the other receptors, the arrangement of the domains relative to each other is very different. The domains are rotated through $\sim 180^\circ$ from the positions adopted in the other Fc receptors, essentially inverting

the D1–D2 orientations. The Fc ϵ RII receptor also has a different structure altogether: its lectin-like head domain binds between the C ϵ 2 and C ϵ 3 domains of IgE Fc.

Crystallographic studies of antibody–Fc receptor complexes have revealed how antibodies interact with leukocyte Fc receptors (Figure 3.16). For the IgG–Fc γ RIII interaction, the D2 membrane-proximal domain of Fc γ RIII interacts with the top of the C γ 2 domains and the bottom of the hinge. This requires the antibody to adopt a “dislocated” conformation in which the

Fab arms are rotated out of the plane of the Fc. One consequence of this mode of interaction, recognized many years ago, is that it promotes close approach of the target cell membrane (upwards on the page) to the effector cell membrane. This may favor effector cell activity against the target cell. Given the similarities between Fc γ RI, Fc γ RII, and Fc γ RIII, it is likely that all three FcRs share a common mode of binding to IgG. Indeed, this mode of binding seems also to be shared by IgE binding to the Fc ϵ RI receptor, although the C ϵ 2–C ϵ 3 domain linker region replaces the hinge contribution to receptor binding. By contrast, IgA binds to the Fc α RI receptor at a site between C α 2 and C α 3 domains. This mode of binding permits an IgA:FcR stoichiometry of 2 : 1, whereas the stoichiometry for IgG and IgE in these complexes is 1 : 1. The significance of these differences in the modes of binding is not understood at this time.

Antibodies and the neonatal Fc receptor

An important Fc receptor for IgG is the neonatal receptor, FcRn. This receptor mediates **transport of IgG from mother to child** across the placenta (Figure 3.17a). Such antibody, surviving for some time in the blood of the newborn child, is believed to be important in directly protecting the child from pathogens. Furthermore, the presence of maternal antibody has been proposed to help the development of cellular immunity in the young child by attenuating pathogen challenge rather than stopping it completely. FcRn may also be important in transporting maternal IgG from mother's milk across the intestinal cells of the young infant to the blood. Equally, FcRn is crucial in **maintaining the long half-life of IgG in serum** in adults and children. The receptor binds IgG in acidic vesicles (pH <6.5),

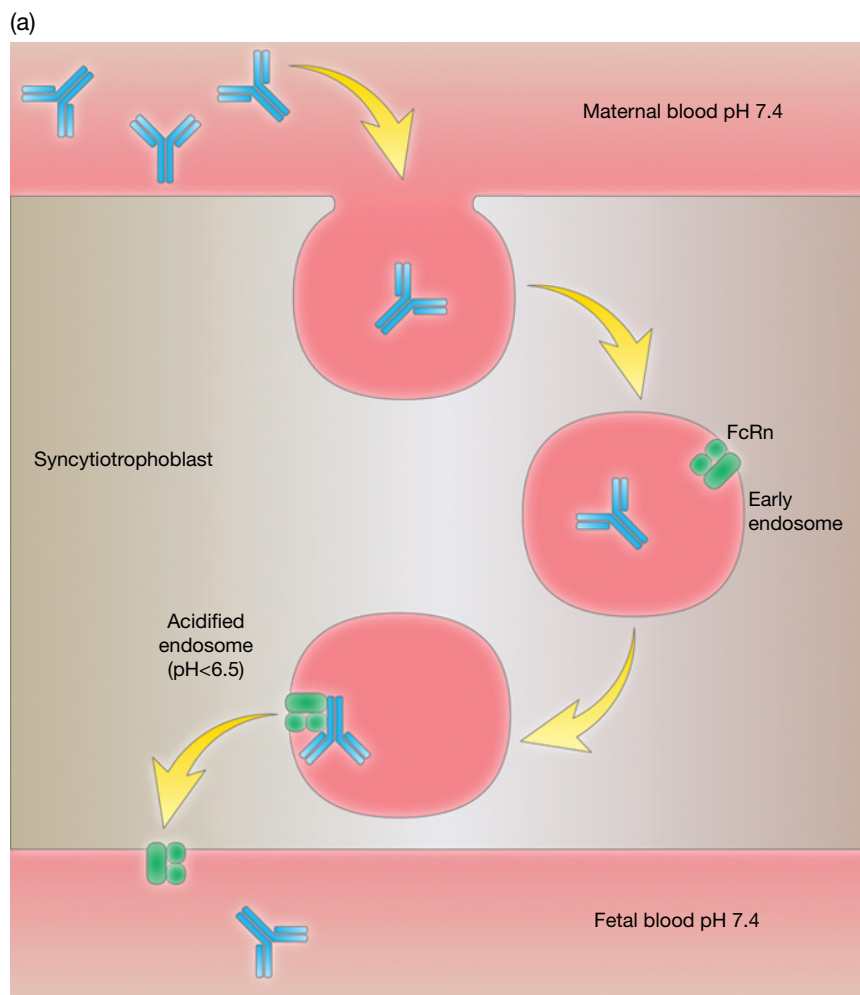


Figure 3.17 Function of the neonatal receptor for IgG (FcRn). (a) The FcRn receptor is present on the syncytiotrophoblast of the placenta where it fulfills the important task of transferring maternal IgG to the fetal circulation. This will provide protection prior to the generation of immunocompetence in the fetus. Furthermore, it is self-evident that any infectious agent that might reach the fetus *in utero* will have had to have passed through the mother first, and the fetus will rely upon the mother's immune system to have produced IgG with appropriate binding specificities. This maternal IgG also provides protection for the neonate, because it takes some weeks following birth before the transferred IgG is eventually all catabolized.

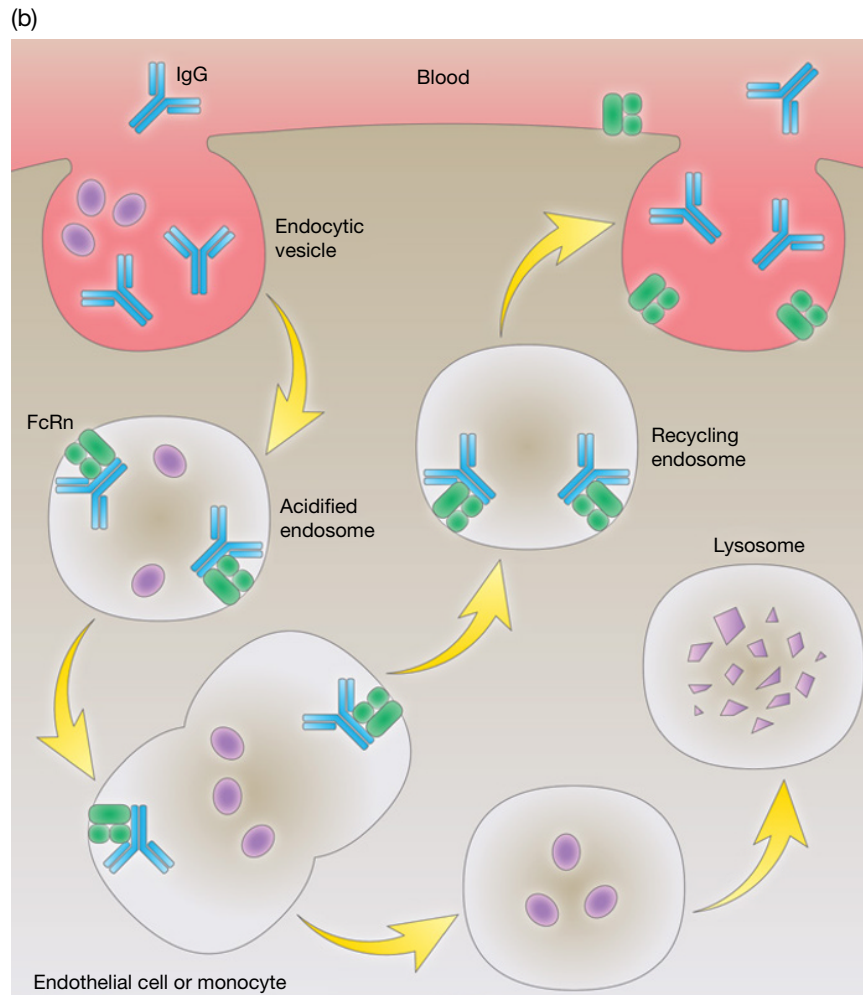


Figure 3.17 (Continued) (b) FcRn expressed on endothelial cells and monocytes is responsible for the long serum half-life of IgG. These cells internalize serum IgG that is then protected against degradation in acidic lysosomes by binding to FcRn. On recycling back to the blood, IgG is released from FcRn in the higher pH conditions. FcRn has other functions as described in the text.

protecting the molecule from degradation, and then releasing the IgG at the higher pH of 7.4 in blood (Figure 3.17b). This constant recycling of IgG and prevention of degradation in endosomes increases the half-life of IgG relative to other antibody isotypes. FcRn has a number of other important functions, including facilitating antigen presentation for antigens derived from the gut, transport of IgG into a number of secretions, and regulation of serum albumin persistence.

Structural studies have revealed the molecular basis for FcRn activity. FcRn is unlike leukocyte Fc receptors and instead has structural similarity to MHC class I molecules. It is a heterodimer composed of a β_2 -microglobulin chain noncovalently attached to a membrane-bound chain that includes three extracellular domains. One of these domains, including a carbohydrate chain, together with β_2 -microglobulin interacts with a site between the C_H2 and C_H3 domains of Fc (Figure 3.18). The interaction includes three salt bridges made to histidine

(His) residues on IgG that are positively charged at pH < 6.5. At higher pH, the His residues lose their positive charges, the FcRn-IgG interaction is weakened and IgG dissociates.

Secretory IgA

IgA appears selectively in the seromucous secretions, such as saliva, tears, nasal fluids, sweat, colostrum, milk, and secretions of the lung, genitourinary, and gastrointestinal tracts, where it defends the exposed external surfaces of the body against attack by microorganisms. This is an important function as approximately 40 mg of secretory IgA/kg body weight is transported daily through the human intestinal crypt epithelium to the mucosal surface as compared with a total daily production of IgG of 30 mg/kg.

The IgA is synthesized locally by plasma cells and dimerized intracellularly together with a cysteine-rich polypeptide

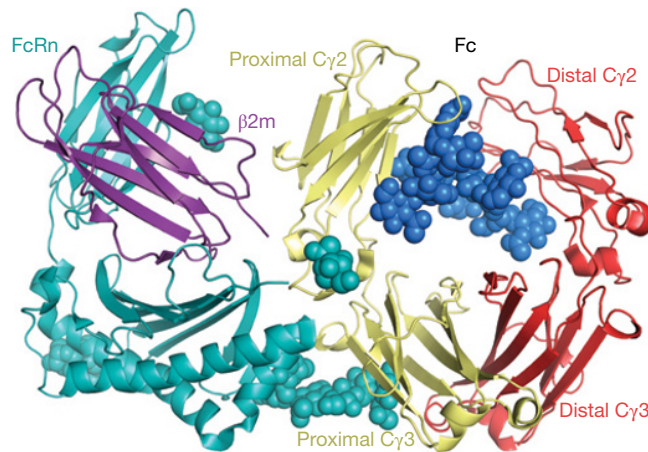


Figure 3.18 Structure of the rat neonatal Fc receptor binding to the Fc of IgG. A heterodimeric Fc (Fc) is shown with the FcRn-binding chain in yellow and the nonbinding chain in red. The red chain has been mutated at several positions to eliminate FcRn binding. If the normal homodimeric molecule is used then oligomeric ribbon structures are created in which FcRn dimers are bridged by Fcs, thereby preventing crystallization. The Fc glycan is shown in dark blue. The three domains of FcRn are shown in azure (two are close together at the bottom of the picture in this view) and β_2 -microglobulin (β_2m) in purple. A portion of the α_2 domain, an N-linked carbohydrate attached to this domain and the C-terminus of β_2 -microglobulin form the FcRn side of the interaction site. Residues at the $C_{\mu}2/C_{\mu}3$ domain interface form the Fc side of the interaction site. (Source: After Martin W.L. *et al.* (2001) *Molecular Cell* 7, 867. Reproduced with permission of Elsevier.)

called J chain, of molecular weight 15 000. Dimeric IgA binds strongly to a receptor for polymeric Ig (*poly-Ig receptor (pIgR)*, which also binds polymeric IgM) present in the membrane of mucosal epithelial cells. The complex is then actively endocytosed, transported across the cytoplasm, and secreted into the external body fluids after cleavage of the pIgR peptide chain. The fragment of the receptor remaining bound to the IgA is termed secretory component and the whole molecule, *secretory IgA* (Figure 3.19).

Isotypes, allotypes, and idiotypes: antibody variants

The variability of antibodies is often conveniently divided into three types: isotypes, allotypes, and idiotypes. *Isotypes* are variants present in all healthy members of a species: immunoglobulin classes and subclasses are examples of isotypic variation involving the constant region of the heavy chain. *Allotypes* are variants that are inherited as alternatives (alleles) and therefore not all healthy members of a species inherit a particular allotype. They occur mostly as variants of heavy chain constant region genes, in humans in all four IgG subclasses, IgA2, and IgM. The nomenclature of human immunoglobulin allotypes is based on the isotype on which it is found (e.g., G1m defines allotypes on an IgG1 heavy chain, Km defines allotypes on k light chains) followed by an accepted World Health Organization (WHO) numbering system.

The variable region of an antibody can act as an antigen, and the unique determinants of this region that distinguish it from most other antibodies of that species are termed its idiotypic determinants. The *idiotypic* of an antibody, therefore,

consists of a set of idiotypic determinants that individually are called idiotopes. Polyclonal anti-idiotypic antibodies generally recognize a set of idiotopes, whereas a monoclonal anti-idiotypic recognizes a single idiotope. Idiotypes are usually specific to an individual antibody clone (private idiotypes) but are sometimes shared between different antibody clones (public, recurrent, or cross-reacting idiotypes). An anti-idiotypic may react with determinants distant from the antigen-binding site, it may fit the binding site and express the image of the antigen, or it may react with determinants close to the binding site and interfere with antigen binding. Sequencing of an anti-idiotypic antibody generated against an antibody specific for the polypeptide GAT antigen in mice revealed a CDR3 with an amino acid sequence identical to that of the antigen epitope (i.e., the anti-idiotypic contains a true image of the antigen) but this is probably the exception rather than the rule.

Genetics of antibody diversity and function

Antibody genes are produced by somatic recombination

The immunoglobulin repertoire is encoded for by multiple germline gene segments that undergo somatic diversification in developing B-cells. Hence, although the basic components needed to generate an immunoglobulin repertoire are inherited, an individual's mature antibody repertoire is essentially formed during their lifetime by alteration of the inherited germline genes.

The first evidence that immunoglobulin genes rearrange by *somatic recombination* was reported by Hozumi and Tonegawa

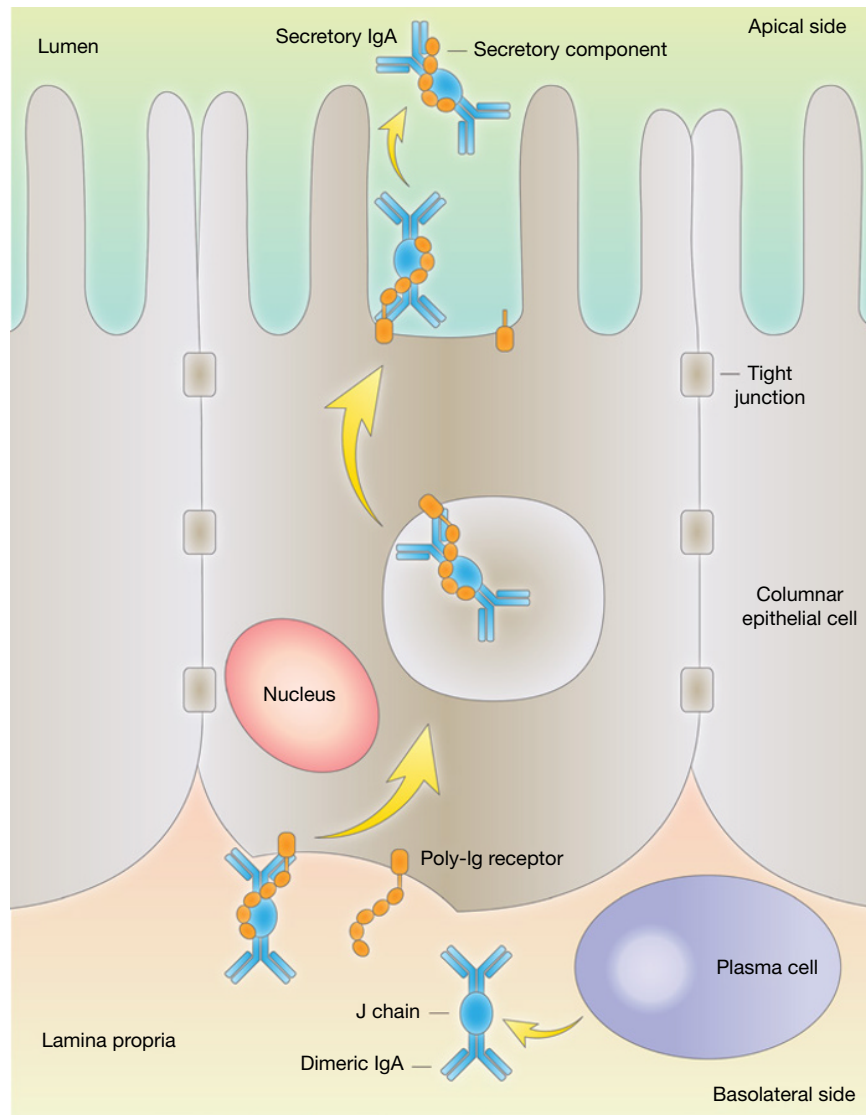


Figure 3.19 IgA secretion at the mucosal surface. Polymeric Ig receptor (pIgR) in the basal membrane binds dimeric IgA and is transported via an endocytic vacuole to the apical surface. Cleavage of the receptor releases secretory IgA still attached to part of the receptor termed the secretory component. Secretory IgA is believed to be very important in protection against exposure to mucosal pathogens.

in 1976 (Milestone 3.2). Because somatic recombination involves rearrangement of DNA in somatic rather than gamete cells, the newly recombined genes are not inherited. As a result, the primary immunoglobulin repertoire will differ slightly from one individual to the next, and will be further modified during an individual's lifetime by their exposure to different antigens.

The immunoglobulin variable gene segments and loci

The variable light and heavy chain loci in humans contain multiple gene segments, which are joined, using somatic recombination, to produce the final V region exon. The human

heavy chain variable region is constructed from the joining of three gene segments, *V(variable)*, *D(diversity)*, and *J(joining)*, whereas the light chain variable gene is constructed by the joining of two gene segments, V and J. There are multiple V, D, and J segments at the heavy chain and light chain loci, as illustrated in Figure 3.20.

The human V_H genes have been mapped to chromosome 14, although orphan IgH genes have also been identified on chromosomes 15 and 16. The human V_H locus, as for other antibody gene segments, is highly polymorphic, and has likely evolved through the repeated duplication, deletion, and recombination of DNA. Polymorphisms found within the germline repertoire are due to the insertion or deletion of gene segments

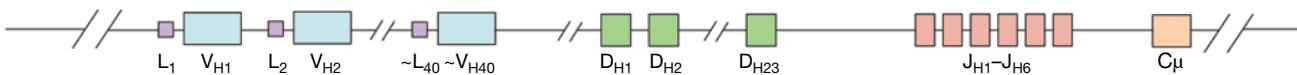


Milestone 3.2 The 1987 Nobel Prize in Physiology or Medicine

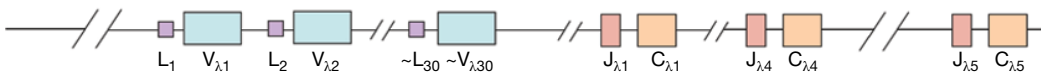
Susumu Tonegawa was awarded the 1987 Nobel Prize in Physiology or Medicine for “his discovery of the genetic principle for generation of antibody diversity.” In his 1976 paper, Tonegawa used Southern blot analysis of restriction enzyme digested DNA from lymphoid and nonlymphoid cells to show that the immunoglobulin variable and constant genes are distant from each other in the germline genome. Embryo DNA showed two components when hybridized to RNA probes specific for:

(i) both variable and constant regions and (ii) only the constant region, whereas both probes localized to a single band when hybridized to DNA from an antibody-producing plasmacytoma cell. He proposed that the differential hybridization patterns could be explained if the variable and constant genes were distant from each other in germline DNA, but came together to encode the complete immunoglobulin gene during lymphocyte differentiation.

IgH, chromosome 14:



Igλ, chromosome 22:



Igκ, chromosome 2:

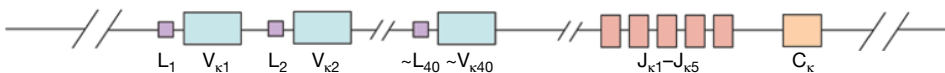


Figure 3.20 The human immunoglobulin loci. Schematics of the human heavy chain (top) and light chain lambda (middle) and kappa (bottom) loci are shown. The human heavy chain locus on chromosome 14 consists of approximately 40 functional V_H genes, 23 D_H genes, and 6 J_H genes, which are organized into clusters upstream of the constant regions. The human lambda locus on chromosome 22 consists of approximately 30 functional V_λ genes and 5 functional J_λ gene segments, with each J segment followed by a constant segment. The human kappa locus on chromosome 2 consists of about 40 functional V_κ genes and 5 functional J_κ genes, with the J segments clustered upstream of the constant region. L, leader sequence.

or the occurrence of different alleles of the same segment. A number of pseudogenes, ranging from those that are more conserved and contain a few point mutations to those that are more divergent with extensive mutations, are also present in immunoglobulin loci. There are approximately 100 human V_H genes, which can be grouped into seven families based on sequence homology. Members of a given family show approximately 80% sequence homology at the nucleotide level. The functional heavy chain repertoire is formed from approximately 40 functional V_H genes, 23 D_H genes and 6 J_H genes. The human lambda locus maps to chromosome 22, with approximately 30 functional V_λ genes and 5 functional J_λ gene segments. The V_λ genes can be grouped into 10 families. The human kappa locus on chromosome 2 is composed of a total of approximately 40 functional V_κ genes and 5 functional J_κ genes. However, the kappa locus contains a large duplication of most of the V_κ genes, and most of the V_κ genes in this distal cluster, although functional, are seldom used. The numbers of V genes vary between individuals as a result of polymorphisms.

The immunoglobulin loci also contain regulatory elements (Figure 3.21) including enhancers at the 3' end of each locus and also in between the J and C regions (intronic enhancer) of the IGH and IGK loci. Both 3' and intronic enhancers are important for $V(D)J$ recombination, whereas the 3' enhancers are more important for the efficient transcription of rearranged Ig genes. Some Ig loci have additional enhancer elements. Each Ig V gene has its own leader sequence and a simple promoter that contains a conserved octamer motif and a TATA box.

$V(D)J$ recombination and combinatorial diversity

The joining of these gene segments, illustrated in Figure 3.22, is known as **$V(D)J$ recombination**. $V(D)J$ recombination is a highly regulated and ordered event. The light chain exon is constructed from a single V -to- J gene segment join. However, at the heavy chain locus, a D segment is first joined to a J segment, and then the V segment is joined to the combined DJ sequence. The rearranged DNA is transcribed, the RNA transcript is

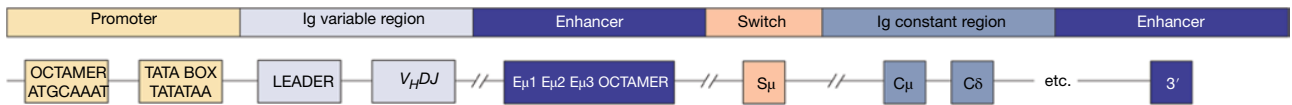


Figure 3.21 Regulatory elements of immunoglobulin loci. Each VDJ segment encoding the variable region is associated with a leader sequence. Closely upstream is the TATA box of the promoter, which binds RNA polymerase II, and the octamer motif that is one of a number of short sequences that bind transacting regulatory transcription factors. The V region promoters are relatively inactive and only association with enhancers, which are also composites of short sequence motifs capable of binding nuclear proteins, will increase the transcription rate to levels typical of actively secreting B-cells. Primary transcripts are initiated 20 nucleotides downstream of the TATA box and extend beyond the end of the constant region. These are spliced, cleaved at the 3' end and polyadenylated to generate the translatable mRNA.

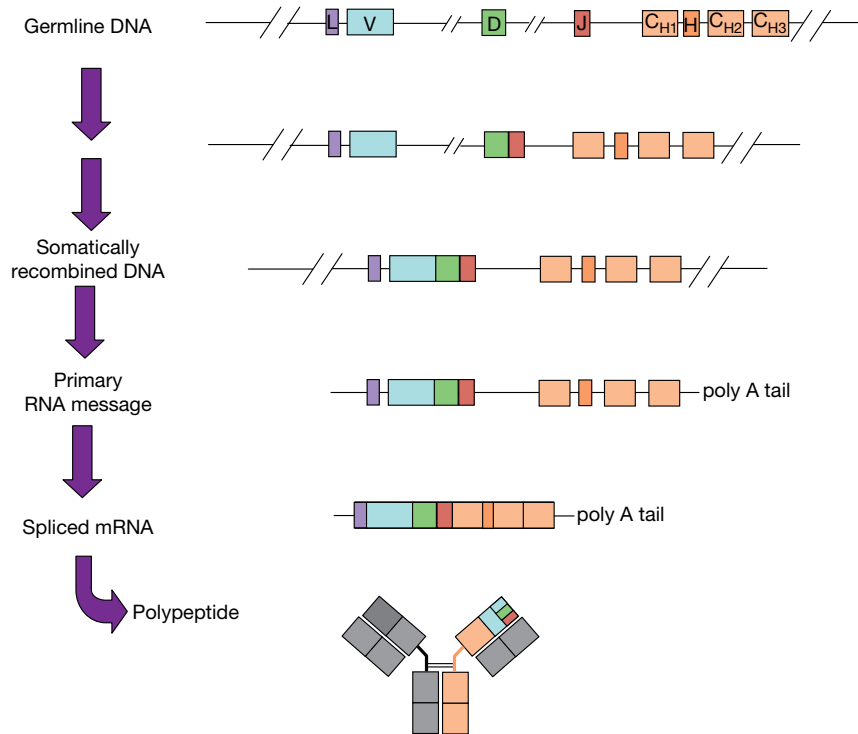


Figure 3.22 Overview of V(D)J recombination. Diversity (D) and joining (J) gene segments in the germline DNA are joined together through somatic recombination at the heavy chain locus. The variable (V) gene segment is then joined to the recombined D–J gene to produce the fully recombined heavy chain exon. At the light chain loci, somatic recombination occurs with V and J segments only. The recombined DNA is transcribed, and the primary RNA transcript is then spliced, bringing together the V and constant (C) regions. The spliced mRNA molecule is translated to produce the immunoglobulin protein. The contribution of the different gene segments to the polypeptide sequence is illustrated for one of the heavy chains. H, hinge.

spliced to bring together the V region exon and the C region exon, and lastly the spliced mRNA is translated to produce the final immunoglobulin protein.

Numerous unique immunoglobulin genes can be made by joining different combinations of the V, D, and J segments at the heavy and light chain loci. The creation of diversity in the immunoglobulin repertoire through this joining of various gene segments is known as **combinatorial diversity**. Additional diversity is created by the pairing of different heavy chains with different lambda or kappa light chains. For example, the potential heavy

chain repertoire is very approximately $40 V_H \times 23 D_H \times 6 J_H = 5500$ different combinations. Similarly, there are very approximately 150 ($30 V_L \times 5 J_L$) and 200 ($40 V_k \times 5 J_k$) different combinations, for a total of 350 light chain combinations. If we consider that each heavy chain could potentially pair with each light chain, then the diversity of the immunoglobulin repertoire would be quite large, on the order of 2 million possible combinations. However, V genes rearrange at very different frequencies, so there is enormous variation in the likelihood of different combinations. Additional diversity is also generated during gene

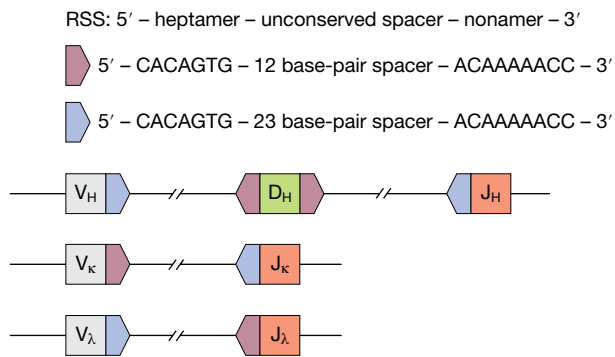


Figure 3.23 The recombination signal sequence. The recombination signal sequence (RSS) is made up of conserved heptamer and nonamer sequences, separated by an unconserved 12- or 23-nucleotide spacer. Efficient recombination occurs between segments with a 12-nucleotide spacer and a 23-nucleotide spacer. RSSs with 23-nucleotide spacers flank the V and J segments of the heavy chain locus, the J segments of the kappa locus and the V segments of the lambda locus, whereas RSSs with 12-nucleotide spacers flank the D segments of the heavy chain locus, the V segments of the kappa locus and the J segments of the lambda locus.

segment recombination and by somatic hypermutation, as explained in the following sections. In this manner, although the number of germline gene segments appears limited in size, an incredibly diverse immunoglobulin repertoire can be generated.

Recombination signal sequences

The **recombination signal sequence** (RSS) helps to guide recombination between appropriate gene segments. The RSS (Figure 3.23) is a noncoding sequence that flanks coding gene segments. It is made up of a conserved heptamer and nonamer sequences, which are separated by an unconserved 12- or 23-nucleotide spacer. Efficient recombination occurs between segments with a 12-nucleotide spacer and a 23-nucleotide spacer. This “**12/23**” rule helps make certain that appropriate gene segments are joined together.

At the V_H locus, the V and J segments are flanked by RSSs with a 23-nucleotide spacer, whereas the D segments are flanked by RSSs with a 12-nucleotide spacer. At light chain loci, the V_k segments are flanked by RSSs with 12-nucleotide spacers, J_k segments are flanked by RSSs with 23-nucleotide spacers, and this arrangement is reversed in the lambda locus.

The recombinase machinery

The V(D)J recombinase is a complex of enzymes that mediates somatic recombination of immunoglobulin gene segments (Figure 3.24). The gene products of recombination-activating genes 1 and 2 (RAG-1 and RAG-2) are lymphocyte-specific enzymes essential for V(D)J recombination. In the initial steps of V(D)J recombination, the RAG complex binds the recombination signal sequences and, in association with high mobility

group (HMG) proteins that are involved in DNA bending, the two recombination signal sequences are brought together. In contrast to the lymphoid-specific RAG enzymes, HMG proteins are ubiquitously expressed.

Next, a single-stranded nick is introduced between the 5'-heptameric end of the recombination signal sequence and the coding segment. This nick results in a free 3' OH group, which attacks the opposite, anti-parallel DNA strand in a transesterification reaction. This attack gives rise to a double-stranded DNA break that leads to the formation of covalently sealed hairpins at the two coding ends and the formation of blunt signal ends. At this stage a post-cleavage complex is formed, in which the RAG recombinase remains associated with the DNA ends.

The DNA break is finally repaired by nonhomologous end-joining machinery. The recombination signal sequences are joined precisely to generate the signal joint. By contrast, nucleotides can be lost or added during repair of the coding ends (Figure 3.25). **Junctional diversity** is the diversification of variable region exons due to this imprecise joining of the coding ends.

First, a small number of nucleotides are often deleted from the coding end by an unknown exonuclease. Also, junctional diversity involves the potential addition of two types of nucleotides, **P-nucleotides** and **N-nucleotides**. The palindromic sequences that result from the asymmetric cleavage and template-mediated fill-in of the coding hairpins are referred to as P-nucleotides. N-nucleotides are generated by the nontemplated addition of nucleotides to the coding ends, which is mediated by the enzyme terminal deoxynucleotidyl transferase (TdT). Although P- and N-nucleotides and deletion of the coding end and nucleotides serve to greatly diversify the immunoglobulin repertoire, the addition of these nucleotides may, as for other events in antibody gene assembly, result in the generation of receptor genes that are out of frame.

Similar to the RAG recombinase complex, the **DNA repair machinery** works as a protein complex. However, unlike the RAG recombinase, the nonhomologous end-joining proteins are ubiquitously expressed. In the first steps of DNA repair, the Ku70 and Ku80 proteins form a heterodimer that binds the broken DNA ends. The Ku complex recruits the catalytic subunit of DNA-dependent protein kinase (DNA-PKcs), a serine-threonine protein kinase. The activated DNA-PKcs then recruits and phosphorylates XRCC4 and Artemis. Artemis is an endonuclease that opens the hairpin coding ends. Finally, DNA ligase IV binds XRCC4 to form an end-ligation complex, and this complex mediates the final ligation and fill-in steps needed to form the coding and signal joints.

Regulating V(D)J recombination

V(D)J recombination and the recombinase machinery must be carefully regulated to avoid wreaking havoc on the cellular genome. For instance, aberrant V(D)J recombination is implicated in certain B-cell lymphomas. V(D)J recombination is

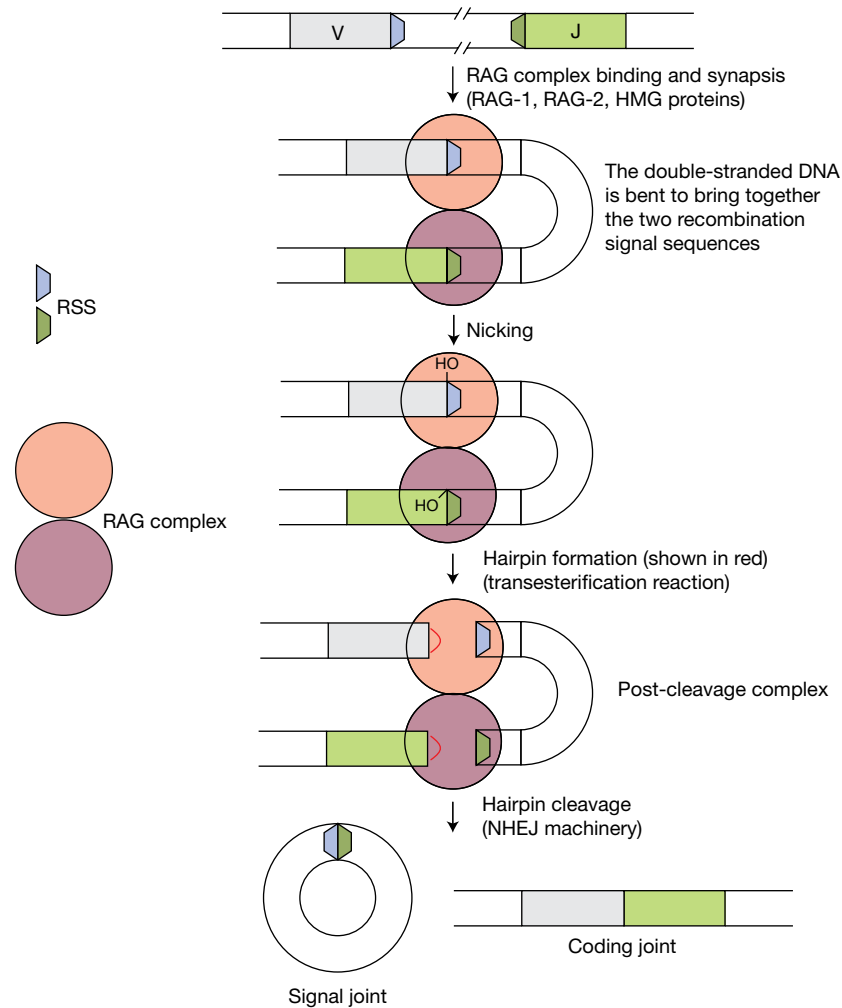


Figure 3.24 The V(D)J recombinase. In the initial steps of V(D)J recombination, the RAG-1 and RAG-2 proteins associate with the recombination signal sequences. A single-stranded nick is then introduced between the 5'-heptameric end of the recombination signal sequence and the coding segment, giving rise to a free 3'-OH group that mediates a transesterification reaction. This reaction leads to the formation of DNA hairpins at the coding ends. Hairpin cleavage and resolution of the post-cleavage complex by nonhomologous end-joining (NHEJ) proteins results in the formation of separate coding and signal joints, in the final steps of V(D)J recombination.

largely regulated by controlling expression of the recombination machinery and the accessibility of gene segments and nearby enhancers and promoters. As previously mentioned, RAG-1 and RAG-2 activity is specific to lymphoid cells, and further regulation is imposed by downregulating RAG activity during appropriate stages of B-cell development. Differential accessibility of gene segments to the recombinase machinery, which can be achieved by altering chromatin structure, also plays a role in making certain that appropriate gene segments are recombined in an appropriate order. *Cis*-acting transcriptional control elements, such as enhancers and promoters, also help regulate recombination. Although it is not a hard and fast rule, transcription from certain regulatory elements seems to correlate with rearrangement of the adjacent genes. This *sterile*, or nonproductive, *transcription* may somehow help target

required proteins or modulate gene accessibility. Finally, in addition to directing recombination between appropriate gene segments, the precise sequences of the RSS itself, as well as the sequences of the gene segments themselves, can influence the efficiency of the recombination reaction.

Somatic hypermutation

Following antigen activation, the variable regions of immunoglobulin heavy and light chains are further diversified by somatic hypermutation. *Somatic hypermutation* involves the introduction of nontemplated point mutations into V regions of rapidly proliferating B-cells in the germinal centers of lymphoid follicles. Antigen-driven somatic hypermutation of variable immunoglobulin genes can result in an increase in

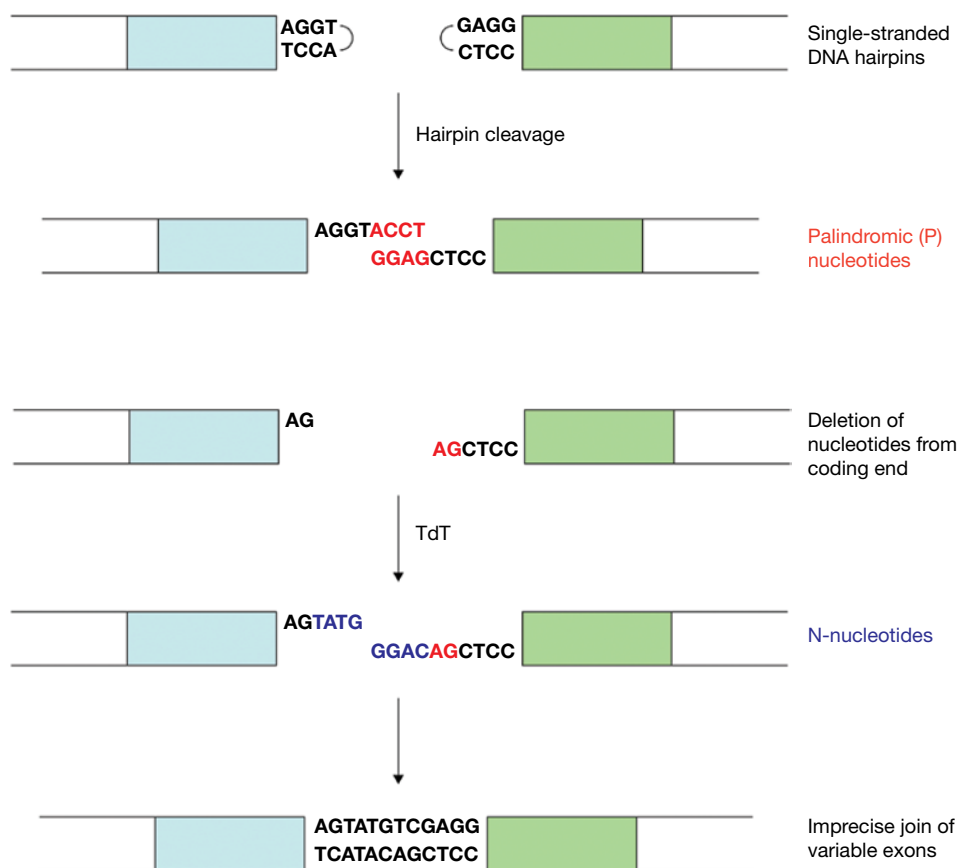


Figure 3.25 Junctional diversity further diversifies the immune repertoire. The immunoglobulin repertoire is further diversified during cleavage and resolution of the coding-end hairpins by deletion of a variable number of coding-end nucleotides, the addition of N-nucleotides by terminal deoxynucleotidyl transferase (TdT), and palindromic (P) nucleotides that arise owing to template-mediated fill-in of the asymmetrically cleaved coding hairpins. TdT randomly adds nucleotides to the DNA ends (N-nucleotides), and the single-stranded ends pair, possibly but not necessarily, through complementary nucleotides (TG on top strand and AC on bottom strand). Exonuclease trimming, to remove unpaired nucleotides, and the DNA repair machinery act to repair the DNA joint.

binding affinity of the B-cell receptor for its cognate ligand. As B-cells with higher affinity immunoglobulins can more successfully compete for limited amounts of antigen present, an increase in the average affinity of the antibodies produced during an immune response is observed. This increase in the average affinity of immunoglobulins is known as **affinity maturation**.

Somatic hypermutation occurs at a high rate, thought to be on the order of about 1×10^{-3} mutations per base-pair per generation, which is approximately 10^6 times higher than the mutation rate of cellular housekeeping genes. There is a bias for transition mutations, and the “mutation hotspots” in variable regions map to RGWY motifs (R=purine, Y=pyrimidine, W=A or T). The exact mechanisms by which mutations are introduced and preferentially targeted to appropriate V regions, while constant regions of the immunoglobulin loci remain protected, is not clearly understood and is the subject of current

research. Transcription through the target V region seems required, but is not sufficient, for somatic hypermutation. Additionally, the enzyme **activation-induced cytidine deaminase (AID)** has been demonstrated to be essential for both somatic hypermutation and class switch recombination.

AID is a cytidine deaminase capable of carrying out targeted deamination of C to U, and shows strong homology with the RNA-editing enzyme APOBEC-1. It appears that AID directly deaminates DNA to produce U : G mismatches. The exact mechanism by which AID can differentially regulate somatic hypermutation and class switch recombination is currently being studied, and may depend on interactions of specific cofactors with specific domains of AID.

Therefore, diversity within the immunoglobulin repertoire is generated by: (i) the combinatorial joining of gene segments; (ii) junctional diversity; (iii) combinatorial pairing of heavy and light chains; and (iv) somatic hypermutation of V regions.

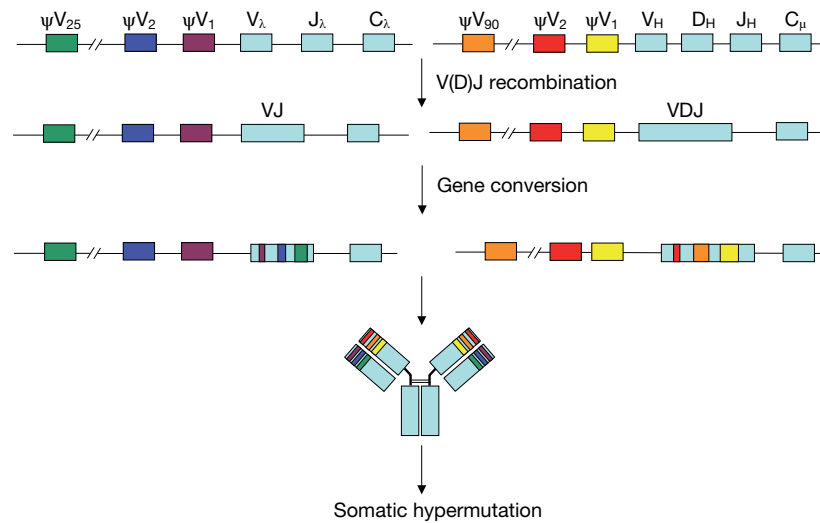


Figure 3.26 Immunoglobulin diversification using gene conversion. V(D)J recombination in chicken B-cells results in assembly of a single variable region exon. In the process of gene conversion, sequences of pseudogenes, located upstream of the functional gene segments, are copied into the recombined variable exons at the light and heavy chain loci in rapidly proliferating B-cells in the bursa of Fabricius. This results in a diversified antibody repertoire.

Gene conversion and repertoire diversification

Although mice and humans use combinatorial and junctional diversity as a mechanism to generate a diverse repertoire, in many species, including birds, cattle, swine, sheep, horses, and rabbits, V(D)J recombination results in assembly and expression of a single functional gene. Repertoire diversification is then achieved by **gene conversion**, a process in which pseudo-V genes are used as templates to be copied into the assembled variable region exon. Further diversification may be achieved by somatic hypermutation.

The process of gene conversion was originally identified in chickens, in which immature B-cells have the same variable region exon. During B-cell development in the bursa of Fabricius, rapidly proliferating B-cells undergo gene conversion to diversify the immunoglobulin repertoire (Figure 3.26). Stretches of sequences from germline variable region pseudogenes, located upstream of the functional V genes, are introduced into the V_L and V_H regions. This process takes place in the ileal Peyer's patches of cattle, swine, and horses, and in the appendix of rabbits. These gut-associated lymphoid tissues are the mammalian equivalent of the bursa in these species.

Class switch recombination

Antigen-stimulated IgM expressing B-cells in germinal centers of secondary lymphoid organs, such as the spleen and lymph nodes, undergo class switch recombination. **Class switch recombination (CSR)** allows the IgH constant region exon of a given antibody to be exchanged for an alternative exon, giving rise to the expression of antibodies with the same antigen specificity but of differing isotypes, and therefore of differing

effector functions as described earlier. CSR occurs through a deletional DNA recombination event at the IgH locus (Figure 3.27), which has been extensively studied in mice. Constant region exons for IgD, IgG, IgE, and IgA isotypes are located downstream of the IgM (C_μ) exon, and CSR occurs between **switch** or **S regions**. S regions are repetitive sequences, which are often G-rich on the nontemplate strand, that are found upstream of each C_H exon except C_δ . Breaks are introduced into the DNA of two S regions and fusion of the S regions leads to a rearranged C_H locus, in which the variable exon is joined to an exon for a new constant region. The DNA between the two switch regions is excised and forms an episomal circle. Finally, alternative splicing of the primary RNA transcript generated from the rearranged DNA gives rise to either membrane-bound or secreted forms of the immunoglobulin.

Prior to recombination between switch regions, transcription is initiated from a promoter found upstream of an exon that precedes all C_H genes capable of undergoing CSR, the intervening (I) exon. These germline transcripts include I, S, and C region exons, and do not appear to code for any functional protein. However, this germline transcription is required, although not sufficient, to stimulate CSR. The precise mechanism responsible for CSR is the subject of current study, but work indicates that AID, described previously to be involved in somatic hypermutation, helps mediate CSR, along with some components of the nonhomologous end-joining pathway and several other DNA repair pathways. The joining of S regions may be mediated by association with transcriptional promoters, enhancers, chromatin factors, DNA repair proteins, AID-associated factors, or by interactions involving S region sequences themselves.

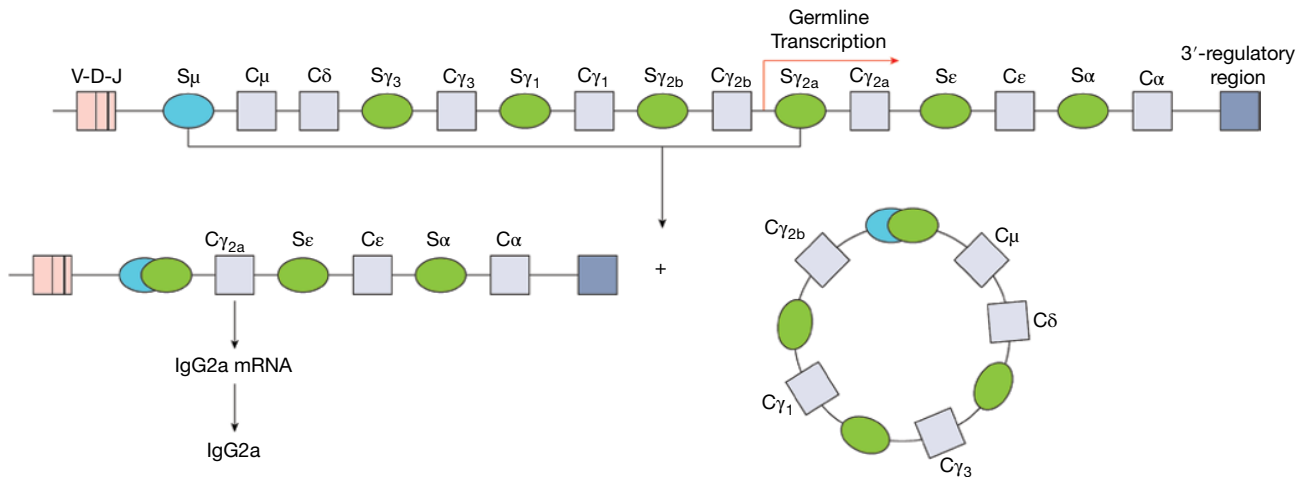


Figure 3.27 Class switch recombination allows expression of different antibody isotypes. It involves DNA recombination at repetitive sequences termed switch or S regions, and is illustrated here for an IgM to IgG2a switch at the mouse heavy chain locus. Switching to an IgG2a isotype begins with germline transcription from the promoter upstream of the constant region exon and recombination between the S_{μ} and $S_{\gamma 2a}$ regions. This DNA recombination reaction brings the IgG2a constant region exon downstream of the variable region exon. The remaining switch regions and constant region exons are deleted and form an episomal circle. Transcription of the rearranged DNA yields IgG2a mRNA, which can be translated to give rise to the IgG2a immunoglobulin protein.

SUMMARY

Antibody structure and function

- Antibodies recognize foreign material and trigger its elimination.
- They are Y- or T-shaped molecules in which the arms of the molecule (Fab) recognize foreign material and the stem (Fc) interacts with immune molecules that lead to the elimination of the antibody-decorated foreign material.
- Antibodies are based on a four-chain structure consisting of two identical heavy chains and two identical light chains.
- The N-terminal parts of the heavy chains and the light chains form the two identical Fab arms that are linked to the Fc stem of the molecule consisting of the C-terminal parts of the heavy chains.
- The extremities of the Fab arms consist of regions of variable amino acid sequences that are involved in binding antigen and thereby give each antibody its unique specificity. The human antibody repertoire is vast, allowing the recognition of essentially any molecular shape.
- The Fc stem of the molecule has a more conserved sequence and is involved in binding effector molecules such as complement and Fc receptors.
- Differences in the Fc regions lead to different classes and subclasses of antibodies or immunoglobulins (Igs).
- There are five different classes of Ig – IgG, IgM, IgA, IgD, and IgE – that fulfill different roles in immune protection. They also have different polymerization states.

- The structure of antibodies is organized into domains based on a β -sheet arrangement called the immunoglobulin fold.
- For IgG, the Fab arms, consisting of two variable domains and two constant domains, are linked via a flexible hinge region to the Fc, which consists of four constant domains.
- Flexibility is an important feature of antibody structure, allowing interaction with antigens and effector molecules in a variety of environments.

Antibody interaction with effector molecules

- IgG triggers complement by binding C1q when clustered on an antigen such as a pathogen. IgM is already multivalent, but on binding antigen it undergoes a conformational change to bind C1q.
- Leukocyte receptors have been described for IgG, IgA, and IgE that, on binding antigen-associated antibody, trigger effector mechanisms such as phagocytosis, antibody-dependent cellular cytotoxicity, and acute inflammatory responses. Interaction between antibody and Fc receptors can also be immunoregulatory.
- The structures of IgG Fc receptors and the mast cell IgE Fc receptor and the mode of interaction of the receptors with Ig appear to be quite similar. The IgA receptor has, however, a distinct structure and mode of interaction with IgA.
- IgG interacts with the neonatal receptor FcRn to promote transport of IgG from mother to child and to maintain the long half-life of IgG in serum.

Overview of the Ig classes

- IgG is monomeric and the major antibody in serum and nonmucosal tissues, where it inactivates pathogens directly and through interaction with triggering molecules such as complement and Fc receptors.
- IgA exists mainly as a monomer in plasma, but in the seromucous secretions, where it is the major Ig concerned in the defense of the external body surfaces, it is present as a dimer linked to a secretory component.
- IgM is most commonly a pentameric molecule, although a minor fraction is hexameric. It is essentially intravascular and is produced early in the immune response. Because of its high valency it is a very effective bacterial agglutinator and mediator of complement-dependent cytolysis and is therefore a powerful first-line defense against bacteremia.
- IgD is largely present on the lymphocyte and functions together with IgM as the antigen receptor on naive B-cells.
- IgE binds very tightly to mast cells and contact with antigen leads to local recruitment of antimicrobial agents through degranulation of the mast cells and release of inflammatory mediators. IgE is of importance in certain

parasitic infections and is responsible for the symptoms of atopic allergy.

The generation of antibody diversity

- The antibody repertoire of an individual is generated through somatic recombination events from a limited set of germline gene segments.
- The human heavy chain variable region is generated by joining of V_H, D, and J gene segments and the light chain variable regions (κ and λ) by joining of V_L and J segments. Joining is imprecise, leading to the generation of further diversity.
- Still further diversification results from somatic mutation events targeted to the variable regions. Somatic mutation and selection allows affinity maturation of antibodies.
- Some species use gene conversion rather than combinatorial and junctional diversity to achieve antibody diversification.
- Class switch recombination events allow the same antibody specificity (variable regions) to be associated with different antibody classes and subclasses (constant regions) and therefore with different functions.



Now visit www.roitt.com to test yourself on this chapter.

FURTHER READING

- Both L., Banyard A.C., van Dolleweerd C., Wright E., Ma J.K., and Fooks A.R. (2013) Monoclonal antibodies for prophylactic and therapeutic use against viral infections. *Vaccine* **31**, 1553–1559.
- Carroll M.C. (2008) Complement and humoral immunity. *Vaccine* **26**, I28–I33.
- Chan A.C. and Carter P.J. (2010) Therapeutic antibodies for autoimmunity and inflammation. *Nature Reviews Immunology* **10**, 301–316.
- Chen K., Xu W., Wilson M., *et al.* (2009) Immunoglobulin D enhances immune surveillance by activating antimicrobial, proinflammatory and B cell-stimulating programs in basophils. *Nature Immunology* **10**, 889–898.
- Diebold C.A., Beurskens F.J., de Jong R.N., *et al.* (2014) Complement is activated by IgG hexamers assembled at the cell surface. *Science* **343**, 1260–1263.
- Di Noia J.M. and Neuberger M.S. (2007) Molecular mechanisms of antibody somatic hypermutation. *Annual Review of Biochemistry* **76**, 1–22.
- Drinkwater N., Cossins B.P., Keeble A.H., *et al.* (2014) Human immunoglobulin E flexes between acutely bent and extended conformations. *Nature Structural and Molecular Biology* **21**, 397–404.
- Ducancel F. and Muller B.H. (2012) Molecular engineering of antibodies for therapeutic and diagnostic purposes. *MABs* **4**, 445–457.
- Holdom M.D., Davies A.M., Nettleship J.E., *et al.* (2011) Conformational changes in IgE contribute to its uniquely slow dissociation rate from receptor FcεRI. *Nature Structural and Molecular Biology* **18**, 571–576.
- Hozumi N. and Tonegawa S. (1976) Evidence for somatic rearrangement of immunoglobulin genes coding for variable and constant regions. *Proceedings of the National Academy of Sciences of the USA* **73**, 3628–3632.
- IMGT database: www.imgt.org/
- Jung D. and Alt F.W. (2004) Unraveling V(D)J recombination: insights into gene regulation. *Cell* **116**, 299–311.
- Jung D., Giallourakis C., Mostoslavsky R., and Alt F.W. (2006) Mechanism and control of V(D)J recombination at the immunoglobulin heavy chain locus. *Annual Review of Immunology* **24**, 541–570.
- Maizels N. (2005) Immunoglobulin gene diversification. *Annual Review of Genetics* **39**, 23–46.
- Maki R., Traunecker A., Sakano H., Roeder W., and Tonegawa S. (1980) Exon shuffling generates an immunoglobulin heavy chain gene. *Proceedings of the National Academy of Sciences of the USA* **77**, 2138–2142.
- Martin W.L., West A.P. Jr, Gan L., and Bjorkman P.J. (2001) Crystal structure at 2.8 Å of an FcRn/heterodimeric Fc complex: mechanism of pH-dependent binding. *Molecular Cell* **7**, 867–877.

- Matsuda F. and Honjo T. (1996) Organization of the human immunoglobulin heavy-chain locus. *Advances in Immunology* **62**, 1–29.
- Matthews A.J., Zheng S., DiMenna L.J., and Chaudhuri J. (2014) Regulation of immunoglobulin class-switch recombination: choreography of noncoding transcription, targeted DNA deamination, and long-range DNA repair. *Advances in Immunology* **122**, 1–57.
- Min I.M. and Selsing E. (2005) Antibody class switch recombination: roles for switch sequences and mismatch repair proteins. *Advances in Immunology* **87**, 297–328.
- Nemazee D. (2006) Receptor editing in lymphocyte development and central tolerance. *Nature Reviews Immunology* **6**, 728–740.
- Neuberger M.S. (2008) Antibody diversification by somatic mutation: from Burnet onwards. *Immunology and Cell Biology* **86**, 124–132.
- Nimmerjahn F. and Ravetch J.V. (2011) Fc γ Rs in health and disease. *Current Topics in Microbiology and Immunology* **350**, 105–125.
- Nimmerjahn F. and Ravetch J.V. (2012) Translating basic mechanisms of IgG effector activity into next generation cancer therapies. *Cancer Immunity* **12**, 13.
- Padlan E.A. (1994) Anatomy of the antibody molecule. *Molecular Immunology* **31**, 169–217.
- Padlan E.A. (1996) X-ray crystallography of antibodies. *Advances in Protein Chemistry* **49**, 57–133.
- Parren P.W. and Burton D.R. (2001) The antiviral activity of antibodies in vitro and in vivo. *Advances in Immunology* **77**, 195–262.
- Peled J.U., Kuang F.L., Iglesias-Ussel M.D., *et al.* (2008) The biochemistry of somatic hypermutation. *Annual Review of Immunology* **26**, 481–511.
- Perlot T. and Alt F.W. (2008) Cis-regulatory elements and epigenetic changes control genomic rearrangements of the IgH locus. *Advances in Immunology* **99**, 1–32.
- Rath T., Kuo T.T., Baker K., *et al.* (2013) The immunologic functions of the neonatal Fc receptor for IgG. *Journal of Clinical Immunology* **33** (Suppl 1), S9–S17.
- Roopenian D.C. and Akilesh S. (2007) FcRn: the neonatal Fc receptor comes of age. *Nature Reviews Immunology* **7**, 715–725.
- Roth D.B. (2003) Restraining the V(D)J recombinase. *Nature Reviews Immunology* **3**, 656–666.
- Schroeder H.W. Jr. and Cavacini L. (2010) Structure and function of immunoglobulins. *Journal of Allergy and Clinical Immunology* **125**, S41–S52.
- Scott A.M., Allison J.P., and Wolchok J.D. (2012) Monoclonal antibodies in cancer therapy. *Cancer Immunity* **12**, 14.
- Strugnell R.A. and Wijburg, O.L.C. (2010) The role of secretory antibodies in infection immunity. *Nature Reviews Microbiology* **8**, 656–667.
- Swanson P.C. (2004) The bounty of RAGs: recombination signal complexes and complex outcomes. *Immunological Reviews* **200**, 90–114.
- Swartz, M.A., Hirosue S., and Hubbell J.A. (2012) Engineering approaches to immunotherapy. *Science Translational Medicine* **4**, 148rv9.
- Vincent K.J. and Zurini M. (2012) Current strategies in antibody engineering: Fc engineering and pH-dependent antigen binding, bispecific antibodies and antibody drug conjugates. *Biotechnology Journal* **7**, 1444–1450.
- Ward E.S. (2004) Acquiring maternal immunoglobulin; different receptors, similar functions. *Immunity* **20**, 507–508.
- Woolf J.M. and Burton D.R. (2004) Human antibody-Fc receptor interactions illuminated by crystal structures. *Nature Reviews Immunology* **4**, 89–99.
- Woolf J.M. and Kerr M.A. (2006) The function of immunoglobulin A in immunity. *Journal of Pathology* **208**, 270–282.

CHAPTER 4

Membrane receptors for antigen

Key topics

- The B-cell surface receptor for antigen (BCR) 99
- The T-cell surface receptor for antigen (TCR) 102
- The generation of diversity for antigen recognition 108
- Invariant natural killer T-cell receptors bridge innate and adaptive immunity 113
- NK receptors 115
- The major histocompatibility complex (MHC) 119
- Pathogen recognition receptors provide the first line of detection for microbial antigen 129

Roitt's Essential Immunology, Thirteenth Edition. Peter J. Delves, Seamus J. Martin, Dennis R. Burton, and Ivan M. Roitt.
 © 2017 John Wiley & Sons, Ltd. Published 2017 by John Wiley & Sons, Ltd.
 Companion website: www.roitt.com

Just to recap ...

Upon maturation by exposure to PAMPs, dendritic cells (DCs) of the innate immune system initiate adaptive immune responses through **presentation of peptides to T-cells** within the context of MHC molecules. MHC molecules function as peptide-binding “billboards” adapted to displaying protein fragments for inspection by T-cell receptors. In response to an appropriate peptide–MHC combination (signal 1) and co-stimulatory B7 molecules (signal 2) presented by the DCs, T-cells become activated and undergo clonal expansion and differentiation to mature effector cells. B-cells, on the other hand, do not require antigen to be presented to them and are capable of directly responding to soluble or particulate antigens through their membrane-bound immunoglobulins (i.e., the B-cell receptor). Thus, the requirements for recognition of antigen by T- and B-cells are quite different. Nonetheless, successful engagement of a T- or B-cell receptor empowers the responding lymphocyte to undergo clonal expansion to produce numerous identical daughter cells capable of recognizing the same antigen. Thus, recognition of antigen by T- or B-cells is a critically important step in the initiation of adaptive immune responses. In Chapter 1 we learned that NK cells can detect differences in the normal patterns of

expression of MHC class I molecules. Because the latter are normally expressed on virtually all cells in the body, their absence is taken as a sign of danger lurking within. Here, we will look in more detail at the membrane receptors for antigen and how the incredible diversity that is displayed by such receptors is acquired. We will also explore the nature of MHC and MHC-like proteins and their central role as an interface between cells of the body and the cells of the immune system.

Introduction

The interaction of lymphocytes with antigen takes place through binding to specialized cell surface antigen-specific receptors functioning as recognition units. In the case of B-cells, the situation is straightforward as membrane-bound immunoglobulin serves as the receptor for antigen (Figure 4.1a). T-cells use distinct antigen receptors, which are also expressed at the plasma membrane, but T-cell receptors (TCRs) differ from B-cell receptors (BCRs) in a very fundamental way; TCRs cannot recognize free antigen as immunoglobulin can. The majority of T-cells can only recognize antigen when presented within the peptide-binding groove of an MHC molecule (Figure 4.1b). Although this

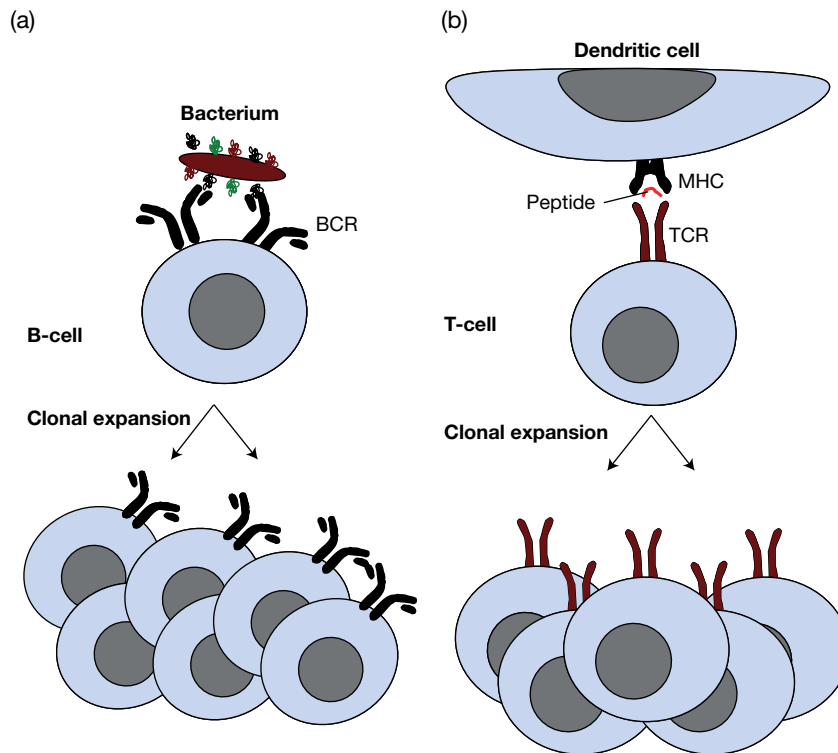


Figure 4.1 B-cells and T-cells “see” antigen in fundamentally different ways. (a) In the case of B-cells, membrane-bound immunoglobulin serves as the B-cell receptor (BCR) for antigen. (b) T-cells use distinct antigen receptors, which are also expressed at the plasma membrane, but T-cell receptors (TCRs) cannot recognize free antigen as immunoglobulin can. The majority of T-cells can only recognize antigen when presented within the peptide-binding groove of an MHC molecule. Productive stimulation of the BCR or TCR results in activation of the receptor-bearing lymphocyte, followed by clonal expansion and differentiation to effector cells.

may seem rather cumbersome, a major advantage that T-cells have over their B-cell brethren is that they can inspect antigens that are largely confined within cells and are therefore inaccessible to Ig.

In this chapter we will see that MHC molecules come in two major flavors, called MHC class I and MHC class II. The major difference between these two classes is in the cellular compartments they acquire their peptide cargoes from. ***MHC class I molecules present peptides that come largely from intracellular sources, whereas class II molecules acquire peptides from extracellular sources.*** There are other differences too, such as structural and tissue expression differences, but the major consequence of the separate locations that the different MHC classes acquire their peptides from is that recognition of a peptide loaded onto a MHC class I molecule will result in killing of that cell, whereas recognition of a peptide within a class II molecule mostly triggers a positive, even helpful, response. This is because a nonself peptide that is being made within a cell (and consequently presented on MHC class I) clearly signifies an intracellular infection and the most effective way to deal with this is to kill the infected cell. However, presentation of a nonself peptide that has been acquired from outside the cell (through phagocytosis), denotes an extracellular infection that will not be resolved by killing the cell that is raising the alarm. Indeed, things are set up in such a way that the only cells capable of presenting peptides on MHC class II molecules are cells that have a role in immunity. In contrast, practically all cells express MHC class I.

Whereas the TCRs of conventional T-cells are capable of detecting a highly varied range of peptide antigens, the receptors of invariant natural killer T-cells (iNKT) recognize a more limited set of conserved antigens and thus display more in common with germline-encoded receptors of the innate immune system. iNKT receptors allow transmission of immune signals in both an innate and adaptive manner, effectively bridging both immune system compartments. Another leukocyte class, natural killer (NK) cells, can also detect trouble brewing within. NK cells possess their own unique receptors that check for appropriate levels of MHC class I molecules, as these are normally expressed on practically all nucleated cells within the body; NK receptors can also detect signs of abnormality, such as increases in the expression of stress proteins by cells.

Another important class of antigen recognition receptor, pathogen recognition receptors (PRRs), expressed primarily on innate immune cells, provide the first point of contact with microbial antigen, and are fundamental to the generation of effective innate and adaptive immune responses. PRRs are germline-encoded receptors that detect conserved components of pathogens, called pathogen-associated molecular patterns (PAMPs), which are essential to pathogen viability and thus refractive to mutation. Here we will focus mainly on the structural aspects of these various receptor types.

The B-cell surface receptor for antigen (BCR)

The B-cell displays a transmembrane immunoglobulin on its surface

In Chapter 2 we discussed the cunning system by which an antigen can be led inexorably to its doom by activating B-cells that are capable of making antibodies complementary in shape to itself through interacting with a copy of the antibody molecule on the lymphocyte surface. It will be recalled that binding of antigen to membrane antibody can activate the B-cell and cause it to proliferate, followed by maturation into a clone of plasma cells secreting antibody specific for the inciting antigen (Figure 4.1a).

Immunofluorescence staining of live B-cells with labeled anti-immunoglobulin (anti-Ig) (e.g., Figure 2.8c) reveals the earliest membrane Ig to be of the IgM class. Each individual B-cell is committed to the production of just one antibody specificity and so transcribes its individual rearranged *VJCK* (or λ) and *VDJ μ* genes. Ig can be either secreted or displayed on the B-cell surface through ***differential splicing*** of the pre-mRNA transcript encoding a particular immunoglobulin. The initial nuclear μ chain RNA transcript includes sequences coding for ***hydrophobic transmembrane regions*** that enable the IgM to sit in the membrane where it acts as the BCR, but if these are spliced out, the antibody molecules can be secreted in a soluble form (Figure 4.2).

As the B-cell matures, it coexpresses a BCR utilizing surface IgD of the same specificity. This surface IgM surface IgD B-cell phenotype is abundant in the mantle zone lymphocytes of secondary lymphoid follicles (see Figure 6.15d) and is achieved by differential splicing of a single transcript containing *VDJ*, *C μ* , and *C δ* segments producing either membrane IgM or IgD (Figure 4.3). As the B-cell matures further, other isotypes such as IgG may be utilized in the BCR.

Surface immunoglobulin is complexed with associated membrane proteins

Because secreted immunoglobulin is no longer physically connected to the B-cell that generated it, there is no way for the B-cell to know when the secreted Ig has found its target antigen. In the case of membrane-anchored immunoglobulin however, there is a direct link between antibody and the cell making it and this can be exploited to instruct the B-cell to scale-up production. As any budding industrialist knows, one way of increasing production is to open up more manufacturing plants, and another is to increase the rate of productivity in each one. When faced with the prospect of a sudden increase in demand for their particular product, B-cells do both of these things, through clonal expansion and differentiation to plasma cells. So how does the BCR spur the B-cell into action upon encounter with antigen?

Unlike many plasma membrane receptors that boast all manner of signaling motifs within their cytoplasmic tails, the

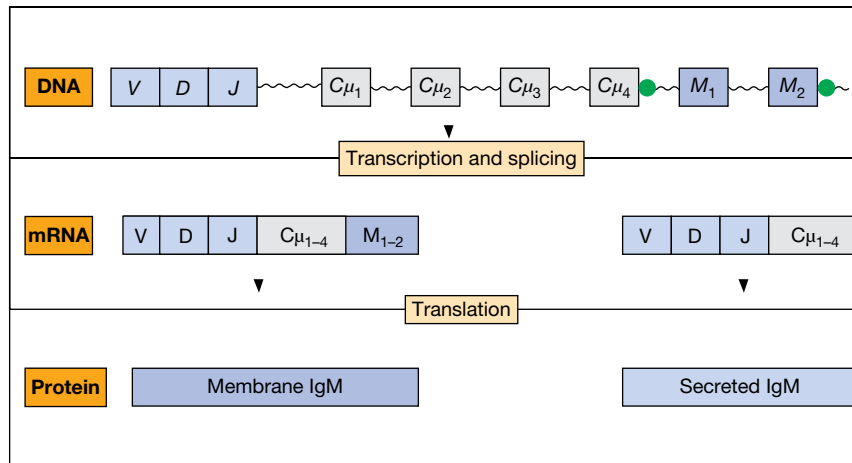


Figure 4.2 Splicing mechanism for the switch from the membrane to the secreted form of IgM. Alternative processing determines whether a secreted or membrane-bound form of the μ heavy chain is produced. If transcription termination or cleavage occurs in the intron between $C\mu_4$ and M_1 , the $C\mu_4$ poly-A addition signal (AAUAAA) is used and the secreted form is produced. If transcription continues through the membrane exons, then $C\mu_4$ can be spliced to the M sequences, resulting in the M_2 poly-A addition signal being utilized. The hydrophobic sequence encoded by the exons M_1 and M_2 then anchors the receptor IgM to the membrane. For simplicity, the leader sequence has been omitted. ~ = introns.

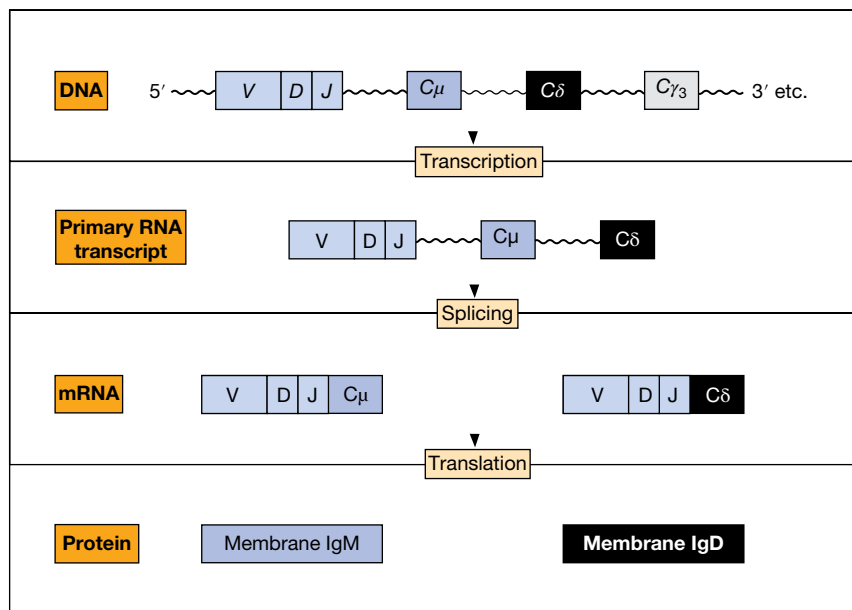


Figure 4.3 Surface membrane IgM and IgD receptors of identical specificity appear on the same cell through differential splicing of the composite primary RNA transcript. Leader sequences again omitted for simplicity.

corresponding tail region of a membrane-anchored IgM is a miserable three amino acids long. In no way could this accommodate the structural motifs required for interaction with the adaptor proteins, intracellular protein kinases, or phosphatases that typically initiate signal transduction cascades. With some difficulty, it should be said, it eventually proved possible to isolate a disulfide-linked heterodimer, *Ig- α* (*CD79a*) and *Ig- β* (*CD79b*), which

copurifies with membrane Ig and is responsible for transmitting signals from the BCR to the cell interior (Figure 4.4). Both *Ig- α* and *Ig- β* have an extracellular immunoglobulin-type domain, but it is their C-terminal cytoplasmic domains that are obligatory for signaling and which become phosphorylated upon cross-linking of the BCR by antigen (Figure 4.5), an event also associated with rapid Ca^{2+} mobilization.

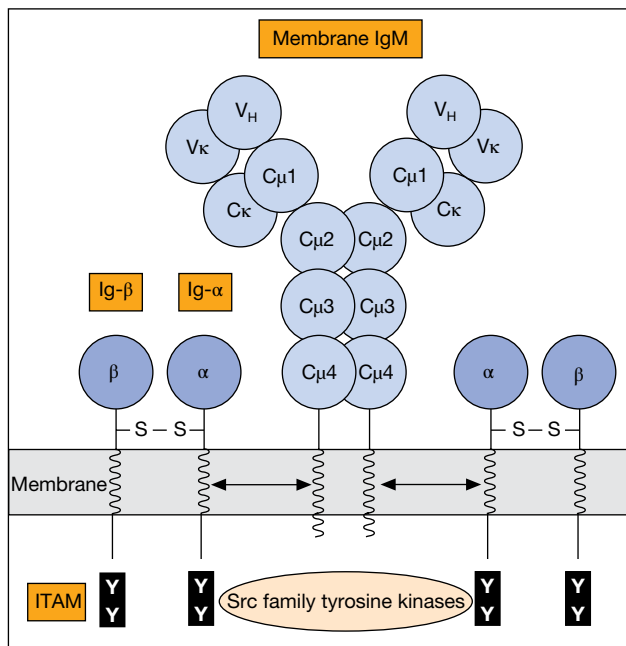


Figure 4.4 Model of B-cell receptor (BCR) complex. The Ig- α /Ig- β heterodimer is encoded by the B-cell-specific genes *mb-1* and *B29*, respectively. Two of these heterodimers are shown with the Ig- α associating with the membrane-spanning region of the IgM μ chain. The Ig-like extracellular domains are colored blue. Each tyrosine (Y)-containing box possesses a sequence of general structure Tyr.X₂.Leu.X₇.Tyr.X₂.Ile (where X is not a conserved residue), referred to as the immunoreceptor tyrosine-based activation motif (ITAM). On activation of the B-cell, these ITAM sequences act as signal transducers through their ability to associate with and be phosphorylated by a series of tyrosine kinases. Note that while a κ light chain is illustrated for the surface IgM, some B-cells utilize a λ light chain.

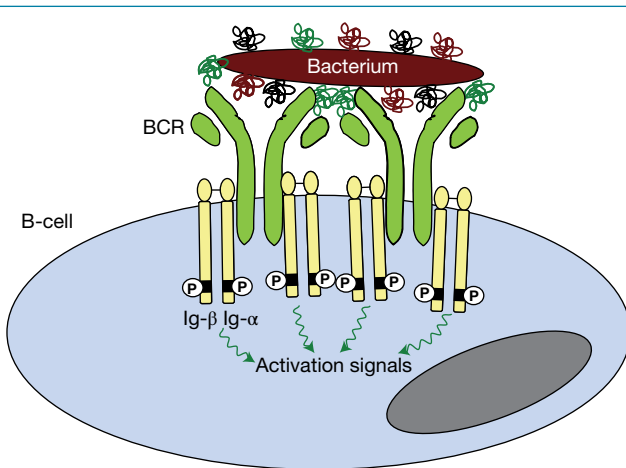


Figure 4.5 B-cell receptor clustering drives activation. Activation of the BCR complex through antigen engagement results in signal propagation as a consequence of phosphorylation of the intracellular ITAMs within the Ig- α /Ig- β heterodimer.

Ig- α and Ig- β each contain a single *ITAM* (*immunoreceptor tyrosine-based activation motif*) within their cytoplasmic tails and this motif contains two precisely spaced tyrosine residues that are central to their signaling role (Figure 4.4 and Figure 4.5). Engagement of the BCR with antigen leads to rapid phosphorylation of the tyrosines within each ITAM, by kinases associated with the BCR, and this has the effect of creating binding sites for proteins that have an affinity for phosphorylated tyrosine residues. In this case, a protein kinase called *Syk* becomes associated with the phosphorylated Ig- α /- β heterodimer and is instrumental in coordinating events that culminate in entry of the activated B-cell into the cell cycle to commence clonal expansion. We will revisit this topic in Chapter 7 where the details of the BCR signal transduction cascade will be elaborated upon in greater detail.

Specific antigen drives formation of B-cell receptor microclusters

Recent studies suggest that many of the BCRs do not freely diffuse within the plasma membrane with their associated Ig- α / β heterodimers, but are constrained within specific zones by the underlying actin cytoskeleton. The actin cytoskeleton does not make contact with the BCR directly but corrals the receptor into confinement zones through interaction with membrane ezrin. There is a good reason for this confinement, as this appears to be required to prevent spontaneous formation of *BCR microclusters*. These appear to be the structures that are capable of transmitting signals into the B-cell that represents an activation stimulus. BCR microclusters are made up of 50–500 BCR molecules and have been visualized on the surface of B-cells using advanced microscopy techniques. Indeed, mere depolymerization of the actin cytoskeleton appears to be sufficient to permit weak B-cell activation signals to occur spontaneously, without any requirement for antigen, suggesting that cytoskeleton-based confinement is necessary and acts as a “safety catch” on BCR triggering. Indeed, weak background or “tonic” BCR signals appear to be necessary for B-cell development, as interference with this situation results in death of developing B-cells. Presumably a small fraction of the BCR pool that is freely diffusible within the plasma membrane provides this tonic signaling.

B-cell activation appears to require that many BCRs become dislodged from their confinement zones to become recruited into microclusters, an event that very recent evidence suggests is achieved through antigen-induced conformational changes within the antibody constant region that permits self-association within the membrane. More effective BCR stimulation is also achieved through *cross-linking of the BCR with its co-receptor complex*, which is discussed below. B-cell activation through BCR stimulation alone is possible, but the former tends to lead to low-affinity IgM production and is far less preferable to co-stimulation via the BCR co-receptor complex.

There is also a growing appreciation that while B-cells can be stimulated by soluble antigen, *the primary form of antigen*

that triggers B-cell activation in vivo is predominantly localized to membrane surfaces. The most likely source of membrane-localized antigen are the follicular dendritic cells that are resident within lymph nodes and are specialized at capturing complement-decorated antigen complexes that diffuse into these lymphoid tissues. Interaction between a B-cell and membrane-immobilized antigen provides the opportunity for the B-cell membrane to spread along the opposing antigen-bearing membrane, gathering sufficient antigen to trigger B-cell microcluster formation and activate the B-cell.

In addition to providing an optimal activation stimulus, there might be another reason why B-cells are keen to engage as many BCRs as possible with specific antigen. This is because **activated B-cells require help**, in the form of cytokines and CD40 receptor stimulation, from T-helper cells, to undergo class switching and somatic hypermutation. This help is only forthcoming if the B-cell can present antigen to T-cells in the context of MHC class II molecules. Thus, the more antigen captured by a stimulated B-cell, the more efficient it will be in subsequently acquiring T-cell help. Thus, spreading along an antigen-coated surface facilitates engagement of many BCRs with antigen, which can then be internalized by the B-cell to be processed and presented to T-helper cells. We will revisit the issue of T-cell–B-cell interactions in Chapters 7 and 8 when we will look at these events in more detail.

The B-cell co-receptor complex synergizes with the BCR to activate B-cells

We have already made reference to the two-signal model for activation of naive T-cells. Similarly, **B-cells also require two signals** (with some exceptions) to become productively activated and this most likely represents a safeguard to limit the production of autoantibodies. Indeed, as we will discuss in more detail in Chapter 7, there are actually two distinct types of co-stimulation a B-cell needs to receive, at different times, for truly optimum activation and subsequent class switching and affinity maturation. One form of co-stimulation takes place at the point of initial encounter of the BCR with its cognate antigen and is provided by the **B-cell co-receptor complex** that is capable of engaging with molecules such as complement that may be decorating the same surface (e.g., on a bacterium) displaying the specific antigen recognized by the BCR (Figure 4.6). The other form of co-stimulation required by B-cells takes place after the initial encounter with antigen and is provided by T-cells in the form of membrane-associated **CD40 ligand** that engages with surface CD40 on the B-cell. We will discuss CD40L-dependent co-stimulation in Chapter 7, as this is not required for initial activation but is very important for class switching and somatic hypermutation.

The B-cell co-receptor complex (Figure 4.6) is composed of four components: CD19, CD21 (complement receptor type 2, CR2), CD81 (TAPA-1), and LEU13 (interferon-induced transmembrane protein 1). CR2 is a receptor for the C3d breakdown product of complement and its presence within the

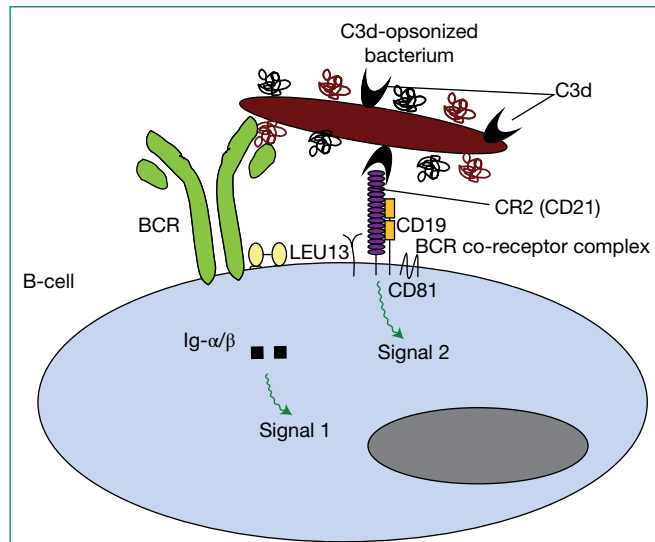


Figure 4.6 The B-cell co-receptor complex synergizes with the BCR to activate B-cells. The B-cell co-receptor complex is composed of four components: CD19, CD21 (complement receptor type 2, CR2), CD81 (TAPA-1), and CD225 (LEU13, interferon-induced transmembrane protein 1, see also Figure 7.29). Because CR2 is a receptor for the C3d breakdown product of complement, its presence within the BCR co-receptor complex enables complement to synergize with the BCR, thereby enhancing B-cell activation signals.

BCR co-receptor complex enables complement to synergize with the BCR, thereby enhancing cross-linking, which drives microcluster formation. Thus, in situations in which a bacterium has activated complement and is coated with the products of complement activation, when it is subsequently captured by the BCR on a B-cell there is now an opportunity for CR2 within the BCR co-receptor complex to bind C3d on the bacterium. This effectively means that the B-cell now receives two signals simultaneously. Signal one comes via the BCR and signal two via the co-receptor complex.

The T-cell surface receptor for antigen (TCR)

As alluded to earlier, T-cells interact with antigen in a manner that is quite distinct from the way in which B-cells do; the receptors that most T-cells are equipped with cannot directly engage soluble antigens but instead “see” fragments of antigen that are immobilized within a narrow groove on the surface of MHC molecules (Figure 4.1b). As we shall discuss in detail in Chapter 5, MHC molecules bind to short 8–20 amino acid long peptide fragments that represent “quality control” samples of the proteins a cell is expressing at any given time, or what it has internalized through phagocytosis, depending on the type of MHC molecule. In this way, T-cells can effectively inspect what is going on, antigenically speaking, within a cell at any given moment by surveying the range of peptides being

presented within MHC molecules. Another major difference between B- and T-cell receptors is that T-cells cannot secrete their receptor molecules in the way that B-cells can switch production of Ig from a membrane-bound form to a secreted form. These differences aside, **T-cell receptors** are structurally quite similar to antibody as they are also built from modules that are based upon the immunoglobulin fold.

Before we explore the structural aspects of T-cell receptors, please keep in mind that the practical function of these receptors is to enable a T-cell to probe the surfaces of cells looking for nonself peptides. If a T-cell finds a peptide–MHC combination that is a good match for its TCR it will become activated, undergo clonal expansion, and differentiate to a mature effector T-cell capable of joining the fight against the infectious agent generating these nonself peptides. In practice, such an eventuality is a very low probability event because, as we shall see, TCRs are generated in such a way as to produce an enormous variety of these receptors, each with their own exquisite specificity for a particular peptide–MHC combination. Moreover, because the majority of peptides presented on MHC molecules at any one time will be derived from self (unless the antigen-presenting cell is infected with a microorganism), this further reduces the probability of a T-cell encountering a perfect nonself peptide–MHC combination to trigger a response.

The receptor for antigen is a transmembrane heterodimer

Identification of the TCR proved more difficult than initially anticipated (Milestone 4.1), but eventually the receptor was found to be a membrane-bound molecule composed of two disulfide-linked chains, α and β . Each chain folds into two Ig-like domains, one having a relatively invariant structure and

the other exhibiting a high degree of variability, so that the $\alpha\beta$ TCR has a structure really quite closely resembling an Ig Fab fragment. This analogy stretches even further – each of the two variable regions has three hypervariable regions (or complementarity determining regions, CDRs) that X-ray diffraction data have defined as incorporating the amino acids that make contact with the peptide–MHC ligand. Plasticity of the CDR loops is an important factor, enabling TCRs to mold around structurally diverse peptide–MHC combinations.

Although the manner in which the TCR makes contact with peptide–MHC is still not fully understood, it appears that in some TCRs CDRs 1 and 2 of the TCR bear much of the responsibility for making contact with the MHC molecule itself, while CDR3 makes contact with the peptide; however in other TCRs the reverse is true. Whatever CDRs bear the responsibility for contacting MHC versus peptide, it is clear that these are the recognition components of the receptor and so it follows that it is here that much of the variability is seen between TCRs, as we shall discuss later.

Both α and β chains are required for antigen specificity as shown by transfection of the T-receptor genes from a cytotoxic T-cell clone specific for fluorescein to another clone of a different specificity; when it expressed the new α and β genes, the transfected clone acquired the ability to lyse the fluoresceinated target cells. Another type of experiment utilized T-cell hybridomas formed by fusing single antigen-specific T-cells with T-cell tumors to achieve “immortality.” One hybridoma recognizing chicken ovalbumin, presented by a macrophage, gave rise spontaneously to two variants, one of which lost the chromosome encoding the α chain, and the other, the β chain. Neither variant recognized antigen but, when they were physically fused together, each supplied the complementary receptor chain, and reactivity with antigen was restored.

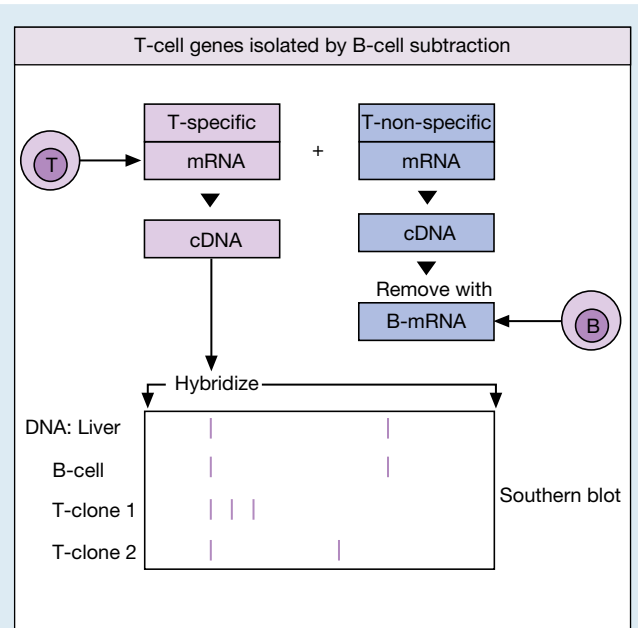
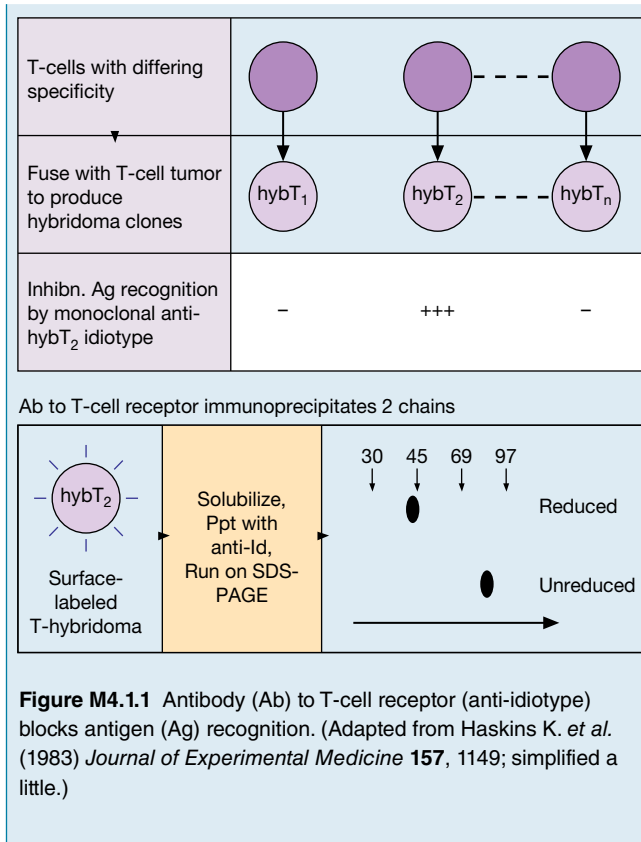


Milestone 4.1 The T-cell receptor

As T-lymphocytes respond by activation and proliferation when they contact antigen presented by cells such as macrophages, it seemed reasonable to postulate that they do so by receptors on their surface. In any case, it would be difficult to fit T-cells into the clonal selection club if they lacked such receptors. Guided by Occam’s razor (the law of parsimony, which contends that it is the aim of science to present the facts of nature in the simplest and most economical conceptual formulations), most investigators plumped for the hypothesis that nature would not indulge in the extravagance of evolving two utterly separate molecular recognition species for B- and T-cells, and many fruitless years were spent looking for the “Holy Grail” of the T-cell receptor with anti-immunoglobulin serums or monoclonal antibodies. Success only came when a monoclonal antibody directed to the idiotype of a T-cell was used to block the response to antigen. This was identified by its ability to block one individual T-cell clone out of a large

number, and it was correctly assumed that the structure permitting this selectivity would be the combining site for antigen on the T-cell receptor. Immunoprecipitation with this antibody brought down a disulfide-linked heterodimer composed of 40–44 kDa subunits (Figure M4.1.1).

The other approach went directly for the genes, arguing as follows. The T-cell receptor should be an integral membrane protein not present in B-cells. Hence, T-cell polysomal mRNA from the endoplasmic reticulum, which should provide an abundant source of the appropriate transcript, was used to prepare cDNA from which genes common to B- and T-cells were subtracted by hybridization to B-cell mRNA. The resulting T-specific clones were used to probe for a T-cell gene that is rearranged in all functionally mature T-cells but is in its germline configuration in all other cell types (Figure M4.1.2). In such a way were the genes encoding the β -subunit of the T-cell receptor uncovered.



CD4 and CD8 molecules act as co-receptors for TCRs

In addition to the TCR, the majority of peripheral T-cells also express one or other of the membrane proteins **CD4** or **CD8** that act as co-receptors for MHC molecules (Figure 4.7). CD4 is a single-chain polypeptide containing four Ig-like domains packed tightly together to form an extended rod that projects from the T-cell surface. The cytoplasmic tail of the CD4 molecule is important for TCR signaling as this region is constitutively bound by a protein tyrosine kinase, **Lck**, that initiates the signal transduction cascade that follows upon encounter of a T-cell with antigen (Figure 4.8). CD8 plays a similar role to CD4, as it also binds Lck and recruits this kinase to the TCR complex, but is structurally quite distinct; CD8 is a disulfide-linked heterodimer of α and β chains, each of which contains a single Ig-like domain connected to an extended and heavily glycosylated polypeptide projecting from the T-cell surface (Figure 4.7).

CD4 and CD8 molecules play important roles in antigen recognition by T-cells as these molecules dictate whether a T-cell can recognize antigen presented by MHC molecules that obtain their peptide antigens primarily from intracellular (**MHC class I**), or extracellular (**MHC class II**), sources. This has major functional implications for the T-cell, as those lymphocytes that become activated upon encounter with antigen presented within MHC class I molecules (CD8⁺ T-cells) invariably become cytotoxic T-cells, and those that are activated by

peptides presented by MHC class II molecules (CD4⁺ T-cells) become helper T-cells (see Figure 7.1).

There are two classes of T-cell receptors

Not long after the breakthrough in identifying the $\alpha\beta$ TCR, reports came of the existence of a second type of receptor composed of γ and δ chains. As it appears earlier in thymic ontogeny, the $\gamma\delta$ receptor is sometimes referred to as **TCR1** and the $\alpha\beta$ receptor as **TCR2**.

The $\gamma\delta$ cells make up only 1–5% of the T-cells that circulate in blood and peripheral organs of most adult animals; however these cells are much more common in epithelial-rich tissues such as the skin, intestine, reproductive tract, and the lungs where they can comprise almost 50% of the T-cell population. It cannot be denied that $\gamma\delta$ T-cells are somewhat of an oddity among T-cells; unlike $\alpha\beta$ T-cells, $\gamma\delta$ cells do not appear to require antigen to be presented within the context of MHC molecules and are thought to be able to recognize soluble antigen akin to B-cells. Perhaps because of this lack of dependence on MHC for antigen presentation, the majority of $\gamma\delta$ T-cells do not express either of the MHC co-receptors, CD4 or CD8 (Table 4.1).

The mechanism of antigen recognition by $\gamma\delta$ T-cells is still somewhat mysterious but these cells are known to be able to interact with MHC-related molecules, such as the mouse T10 and T22 proteins, in a manner that does not require antigen. Because the latter MHC-like molecules are upregulated upon

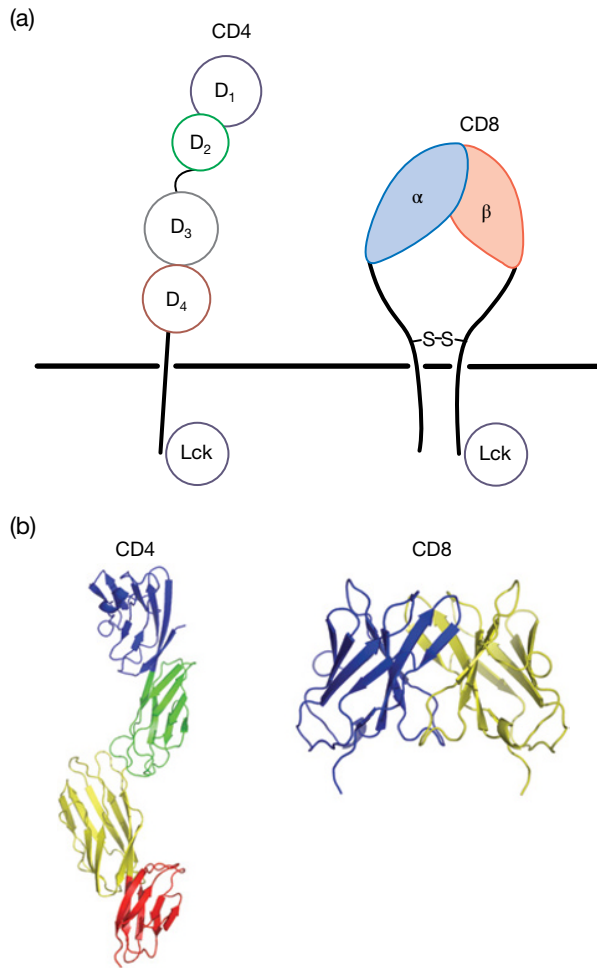


Figure 4.7 CD4 and CD8 act as co-receptors for MHC molecules and define functional subsets of T-cells. (a) Schematic representation of CD4 and CD8 molecules. CD4 is composed of four Ig-like domains (D_1 to D_4 , as indicated) and projects from the T-cell surface to interact with MHC class II molecules. CD8 is a disulfide-linked heterodimer composed of Ig-like α and β subunits connected to a heavily glycosylated rod-like region that extends from the plasma membrane. CD8 interacts with MHC class I molecules. The cytoplasmic tails of CD4 and CD8 are associated with the tyrosine kinase Lck. (b) Ribbon diagram representations of the extracellular portions of CD4 and CD8. The Ig-like domains (D_1 to D_4) of CD4 are colored blue, green, yellow, and red, respectively. A CD8 homodimer of two α subunits is shown. (Source: Dr. Dan Leahy. Reproduced with permission.)

activation of $\alpha\beta$ T-cells, this has led to the view that $\gamma\delta$ T-cells may have an important immunoregulatory function; by becoming activated by molecules that appear on activated T-cells, $\gamma\delta$ T-cells may help to regulate immune responses in a positive or negative manner. $\gamma\delta$ T-cells can also recognize pathogen-derived lipids, organic phosphoesters, nucleotide conjugates, and other nonpeptide ligands.

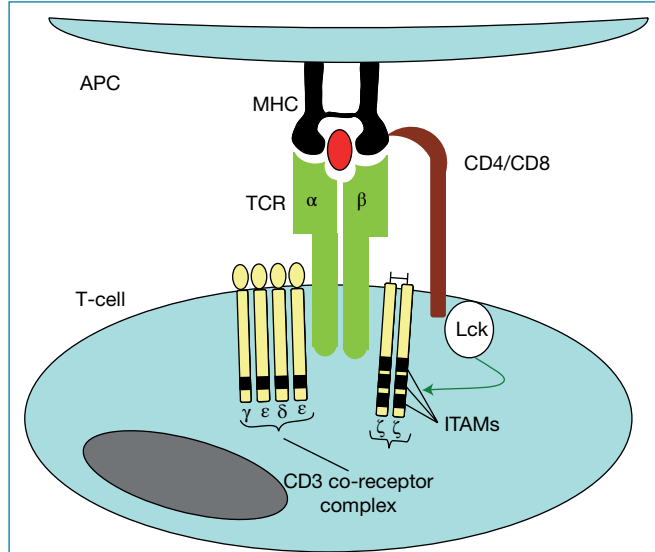


Figure 4.8 The T-cell receptor (TCR) complex, assisted by CD4 or CD8 receptors, recognizes peptide antigen in the context of MHC molecules. TCR activation signals are propagated via the CD3 co-receptor complex, which is made up of CD3 γ , ϵ , δ , and ζ chains. Co-clustering of CD4 or CD8, which are constitutively associated with the Lck kinase, with the TCR complex facilitates Lck-initiated signal propagation through phosphorylation of immunoreceptor tyrosine-based activation motifs (ITAMs) within the CD3 ζ chain.

Certain $\gamma\delta$ T-cells (the $V\gamma 1 V\delta 1$ subset, which are enriched in epithelial tissues) also share some of the same recognition features of NK cells of the innate immune system, as they can both recognize the MHC class I-like proteins MICA and MICB, which do not function as antigen-presenting molecules. Rather, MICA and MICB are typically present at low levels on epithelial tissues but are upregulated in response to cellular stress, including heat shock and DNA damage. Infection with cytomegalovirus or *Mycobacterium tuberculosis* is also capable of inducing the surface appearance of these primitive MHC-like molecules and other stress-inducible $\gamma\delta$ T-cell ligands are almost certain to exist. As we shall see later in this chapter, MICA and MICB are also used by NK cells as activation ligands, although in this case a very different receptor is responsible.

The encoding of TCRs is similar to that of immunoglobulins

The gene segments encoding the TCR β chains follow a broadly similar arrangement of V , D , J , and constant segments to that described for the immunoglobulins (Figure 4.9). In a parallel fashion, as an immunocompetent T-cell is formed, rearrangement of V , D , and J genes occurs to form a continuous VDJ sequence. The firmest evidence that B- and T-cells use similar recombination mechanisms comes from mice with severe combined immunodeficiency (SCID) that have a single autosomal

Table 4.1 Comparison between $\alpha\beta$ and $\gamma\delta$ T-cells.

Characteristic	$\alpha\beta$ T-cells	$\gamma\delta$ T-cells
Antigen receptor	$\alpha\beta$ TCR–CD3 complex	$\gamma\delta$ TCR–CD3 complex
Form of antigen recognized	MHC + peptide	MHC-like molecules plus nonprotein ligands
CD4/CD8 expression	Yes	Mainly no
Frequency in blood	60–75%	1–5%
MHC restricted	Yes	Mostly no
Function	Help for lymphocyte and macrophage activation Cytotoxic killing	Immunoregulatory function? Cytotoxic activity

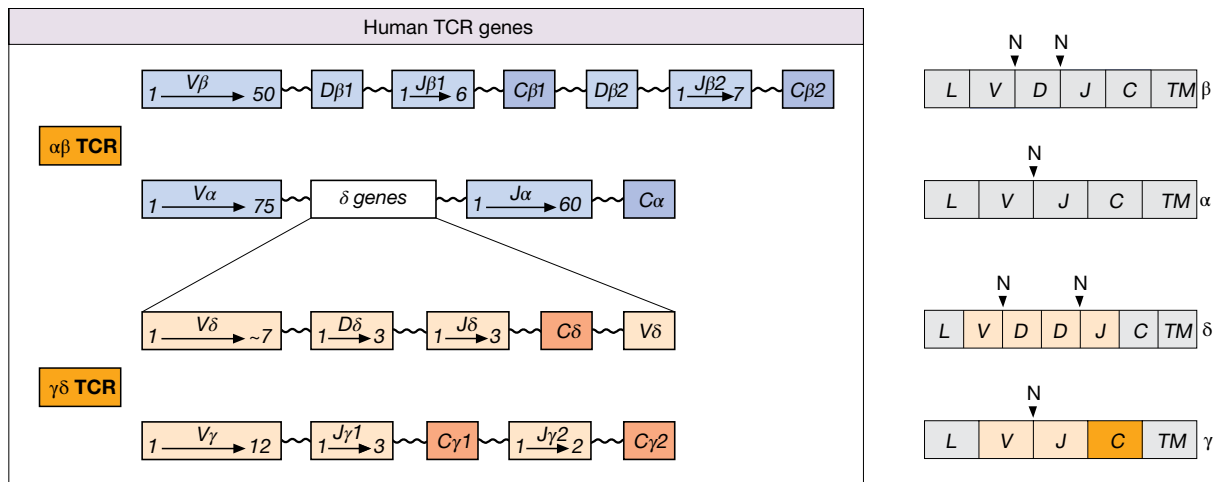


Figure 4.9 Genes encoding $\alpha\beta$ and $\gamma\delta$ T-cell receptors (TCRs). Genes encoding the δ chains lie between the $V\alpha$ and $J\alpha$ clusters and some V segments in this region can be used in either δ or α chains (i.e., as either $V\alpha$ or $V\delta$). TCR genes rearrange in a manner analogous to that seen with immunoglobulin genes, including N-region diversity at the $V(D)J$ junctions. One of the $V\delta$ genes is found downstream (3') of the $C\delta$ gene and rearranges by an inversional mechanism.

recessive defect preventing successful recombination of V , D , and J segments. Homozygous mutants fail to develop immunocompetent B- and T-cells and identical sequence defects in VDJ joint formation are seen in both pre-B- and pre-T-cell lines.

Looking first at the β chain cluster, one of the two $D\beta$ genes rearranges next to one of the $J\beta$ genes. Note that, because of the way the genes are organized, the first $D\beta$ gene, $D\beta 1$, can utilize any of the 13 $J\beta$ genes, but $D\beta 2$ can only choose from the seven $J\beta 2$ genes (Figure 4.9). Next, one of the 50 or so $V\beta$ genes is rearranged to the preformed $D\beta J\beta$ segment. **Variability in junction formation** and the **random insertion of nucleotides** to create N-region diversity either side of the D segment mirror the same phenomenon seen with Ig gene rearrangements. Sequence analysis emphasizes the analogy with the antibody molecule; each V segment contains two hypervariable regions, while the DJ junctional sequence provides the **very hypervariable** CDR3 structure, making a total of six potential CDRs for antigen binding in each TCR (Figure 4.10). As in the synthesis of antibody, the intron between VDJ and C is spliced out of the mRNA

before translation with the restriction that rearrangements involving genes in the $D\beta 2 J\beta 2$ cluster can only link to $C\beta 2$.

All the other chains of the TCRs are encoded by genes formed through similar translocations. The α chain gene pool lacks D segments but possesses a prodigious number of J segments. The number of $V\gamma$ and $V\delta$ genes is small in comparison with $V\alpha$ and $V\beta$. Like the α chain pool, the β chain cluster has no D segments. The awkward location of the δ locus embedded within the α gene cluster results in T-cells that have undergone $V\alpha$ – $J\alpha$ combination having no δ genes on the rearranged chromosome; in other words, the δ genes are completely excised.

The CD3 complex is an integral part of the T-cell receptor

The T-cell antigen recognition complex and its B-cell counterpart can be likened to army scouts whose job is to let the main battalion know when the enemy has been sighted. When the TCR “sights the enemy” (i.e., ligates antigen), it relays a signal

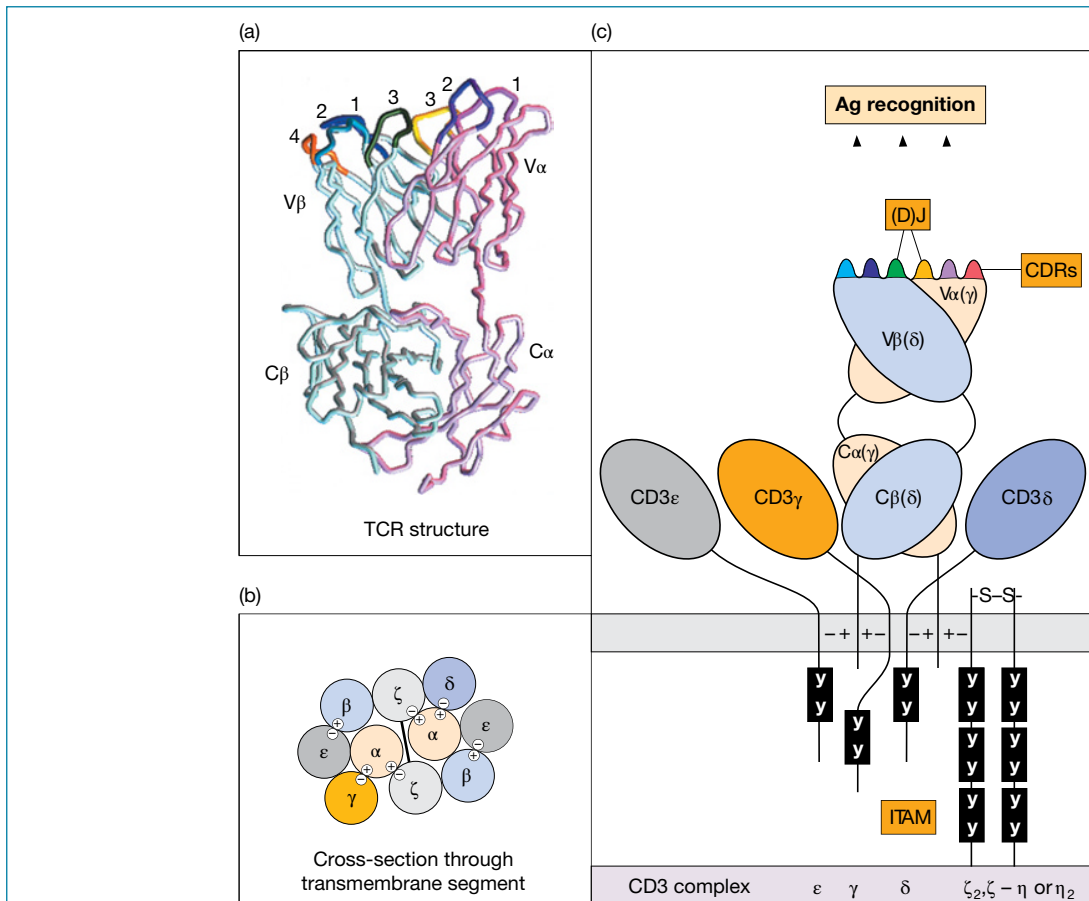


Figure 4.10 The T-cell receptor (TCR)/CD3 complex. The TCR resembles the immunoglobulin Fab antigen-binding fragment in structure. The variable and constant segments of the TCR α and β chains ($V\alpha C\alpha/V\beta C\beta$), and of the corresponding γ and δ chains of the $\gamma\delta$ TCR, belong structurally to the immunoglobulin-type domain family. (a) In the model the α chain CDRs are colored magenta (CDR1), purple (CDR2), and yellow (CDR3), whilst the β chain CDRs are cyan (CDR1), navy blue (CDR2) and green (CDR3). The fourth hypervariable region of the β chain (CDR4), which constitutes part of the binding site for some superantigens, is colored orange. (Reproduced from Garcia K. *et al.* (1998) *Science* 279, 1166; with permission.) The TCR α and β CDR3 loops encoded by $(D)J$ genes are both short; the TCR γ CDR3 is also short with a narrow length distribution, but the δ loop is long with a broad length distribution, resembling the Ig light and heavy chain CDR3s, respectively. (b) The TCRs may be expressed in pairs linked to the CD3 complex. Negative charges on transmembrane segments of the invariant chains of the CD3 complex contact the opposite charges on the TCR $C\alpha$ and $C\beta$ chains conceivably as depicted. (c) The cytoplasmic domains of the CD3 peptide chains contain immunoreceptor tyrosine-based activation motifs (ITAMs; see BCR, Figure 4.4) that contact src protein tyrosine kinases. Try not to confuse the TCR $\gamma\delta$ and the CD3 $\gamma\delta$ chains.

through an associated complex of transmembrane polypeptides (**CD3**) to the interior of the T-lymphocyte, instructing it to awaken from its slumbering G0 state and do something useful – like becoming an effector cell. In all immunocompetent T-cells, the TCR is noncovalently but still intimately linked with CD3 in a complex that, as current wisdom has it, may contain two heterodimeric TCR $\alpha\beta$ or $\gamma\delta$ recognition units closely apposed to one molecule of the invariant CD3 polypeptide chains γ and δ , two molecules of CD3 ϵ , plus the disulfide-linked ζ - ζ dimer. The total complex therefore has the structure TCR2-CD3 $\gamma\delta\epsilon$ 2- ζ 2 (Figure 4.8 and Figure 4.10b).

Similar to the BCR-associated Ig- α/β heterodimer, the CD3 chains also contain one or more ITAMs and these motifs, once again, are instrumental in the propagation of activation

signals into the lymphocyte. Upon encounter of the TCR with peptide-MHC, the ITAMs within the CD3 complex become phosphorylated at tyrosine residues; these then act as a platform for the recruitment of a veritable multitude of phosphotyrosine-binding proteins that further disseminate the signal throughout the T-cell. It is here that the role of the CD4 and CD8 co-receptors becomes apparent; phosphorylation of the ITAMs within the CD3 ζ (zeta) chain is accomplished by the Lck tyrosine kinase that, you may recall, is associated with the cytoplasmic tails of CD4 and CD8 (Figure 4.7 and Figure 4.8). In mice, either or both of the ζ chains can be replaced by a splice variant from the ζ gene termed η . The ζ chain also associates with the Fc γ RIIIA receptor in natural killer (NK) cells where it functions as part of the signal transduction mechanism

in that context also. We shall discuss TCR-initiated signal transduction in much greater detail in Chapter 7.

The generation of diversity for antigen recognition

We know that the immune system has to be capable of recognizing virtually any pathogen that has arisen or might arise. The awesome genetic solution to this problem of anticipating an unpredictable future involves the generation of millions of different specific antigen receptors, probably vastly more than the lifetime needs of the individual. As this greatly exceeds the estimated number of 25 000–30 000 genes in the human body, there are some clever ways to generate all this diversity, particularly as the total number of *V*, *D*, *J*, and *C* genes in an individual human coding for antibodies and TCRs is only around 400. Let's revisit the genetics of antibody diversity, and explore the enormous similarities, and occasional differences, seen with the mechanisms employed to generate TCR diversity.

Intrachain amplification of diversity

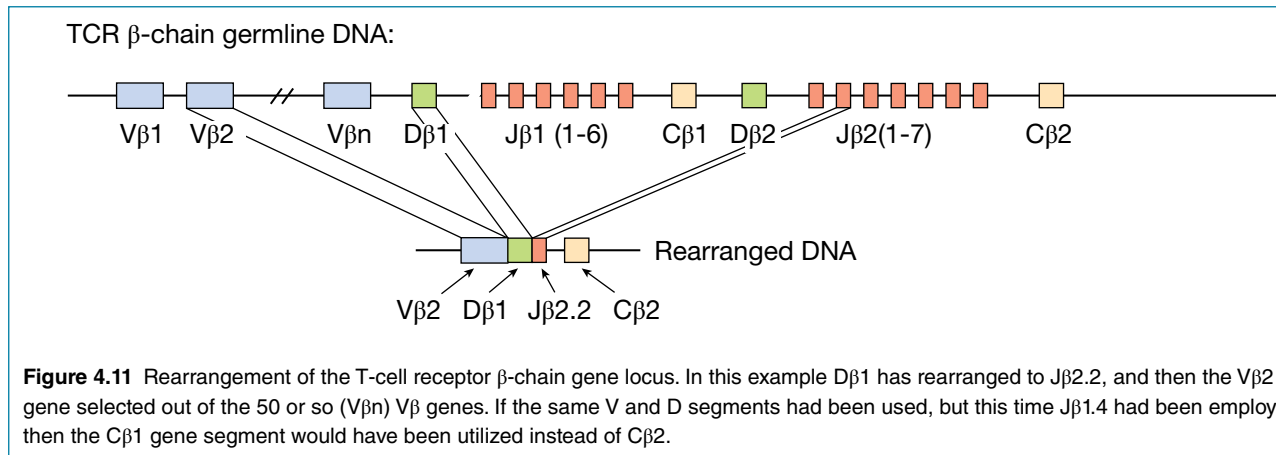
Random VDJ combination increases diversity geometrically

We saw in Chapter 3 that, just as we can use a relatively small number of different building units in a child's construction set such as LEGO® to create a rich variety of architectural masterpieces, so the individual receptor gene segments can be viewed as

building blocks to fashion a multiplicity of antigen specific receptors for both B- and T-cells. The immunoglobulin light chain variable regions are created from *V* and *J* segments, and the heavy chain variable regions from *V*, *D*, and *J* segments. Likewise, for both the $\alpha\beta$ and $\gamma\delta$ T-cell receptors the variable region of one of the chains (α or γ) is encoded by a *V* and a *J* segment, whereas the variable region of the other chain (β or δ) is additionally encoded by a *D* segment. As for immunoglobulin genes, the enzymes RAG-1 and RAG-2 recognize recombination signal sequences (RSSs) adjacent to the coding sequences of the TCR *V*, *D*, and *J* gene segments. The RSSs again consist of conserved heptamers and nonamers separated by spacers of either 12 or 23 base-pairs and are found at the 3' side of each *V* segment, on both the 5' and 3' sides of each *D* segment, and at the 5' of each *J* segment. Incorporation of a *D* segment is always included in the rearrangement; $V\beta$ cannot join directly to $J\beta$, nor $V\delta$ directly to $J\delta$. To see how sequence diversity is generated for TCR, let us take the $\alpha\beta$ TCR as an example (Table 4.2). Although the precise number of gene segments varies from one individual to another, there are typically around 75 *V α* gene segments and 60 *J α* gene segments. If there were entirely *random joining* of any one *V* to any one *J* segment, we would have the possibility of generating 4500 *VJ* combinations (75×60). Regarding the TCR β -chain, there are approximately 50 *V β* genes that lie upstream of two clusters of *D β J β* genes, each of which is associated with a *C β* gene (Figure 4.11). The first cluster, associated with *C β 1*, has a single *D β 1* gene and 6 *J β 1* genes, whereas the second cluster associated with *C β 2* again has a single *D β* gene (*D β 2*) with 7 *J β 2* genes.

Table 4.2 Calculations of human *V* gene diversity. It is known that the precise number of gene segments varies from one individual to another, perhaps 40 or so in the case of the *V_H* genes for example, so that these calculations represent "typical" numbers. The number of specificities generated by straightforward random combination of germline segments is calculated. These will be increased by the further mechanisms listed: *Minimal assumption of approximately 10 variants for chains lacking *D* segments and 100 for chains with *D* segments. The calculation for the TCR β chain requires further explanation. The first of the two *D* segments, *D β 1*, can combine with 50 *V* genes and with all 13 *J β 1* and *J β 2* genes. *D β 2* behaves similarly but can only combine with the 7 downstream *J β 2* genes.

	$\gamma\delta$ TCR (TCR1)		$\alpha\beta$ TCR (TCR2)			Ig	
	γ	δ	α	β	H	L	
						κ	λ
V gene segments	12	~8	75	50	40	40	30
D gene segments	–	3	–	1,1	23	–	–
J gene segments	3,2	3	60	6,7	6	5	5
Random combinatorial joining (without junctional diversity)	$V \times J$ 12 × 5	$V \times D \times J$ 8 × 3 × 3	$V \times J$ 75 × 60	$V \times D \times J$ 50(13 + 7)	$V \times D \times J$ 40 × 23 × 6	$V \times J$ 40 × 5	$V \times J$ 30 × 5
Total	60	72	4500	1000	5520	200	150
Combinatorial heterodimers	60 × 72		4500 × 1000		5520 × 200		5520 × 150
Total (rounded)	4.3×10^3		4.5×10^6		1.1×10^6		0.8×10^6
Other mechanisms: <i>D</i> s in 3 reading frames, junctional diversity, <i>N</i> region insertion; × 10 ³	4.3×10^6		4.5×10^9		1.3×10^9		1.0×10^9
Somatic mutation	–		–		+++		+++



The $D\beta 1$ segment can combine with any of the 50 $V\beta$ genes and with any of the 13 $J\beta 1$ and $J\beta 2$ genes (Figure 4.11). $\beta 2$ behaves similarly but can only combine with one of the 7 downstream $J\beta 2$ genes. This provides 1000 different possible VDJ combinations for the TCR β -chain. Therefore, although the TCR α and β chain V , D , and J genes add up arithmetically to just 200, they produce a vast number of different α and β variable regions by *geometric recombination* of the basic elements. But, as with immunoglobulin gene rearrangement, that is only the beginning.

Playing with the junctions

Another ploy to squeeze more variation out of the germline repertoire that is used by both the TCR and the immunoglobulin genes (see Figure 3.25) involves variable boundary recombinations of V , D , and J to produce different junctional sequences (Figure 4.12.).

As discussed in Chapter 3, further diversity results from the generation of palindromic sequences (P-elements) arising from the formation of hairpin structures during the recombination process and from the insertion of nucleotides at the N region between the V , D , and J segments, a process associated with the expression of terminal deoxynucleotidyl transferase. While these mechanisms add nucleotides to the sequence, yet more diversity can be created by nucleases chewing away at the exposed strand ends to remove nucleotides. These maneuvers again greatly increase the repertoire, especially important for the TCR γ and δ genes, which are otherwise rather limited in number.

Additional mechanisms relate specifically to the D -region sequence: particularly in the case of the TCR δ genes, where the D segment can be read in three different reading frames and two D segments can join together. Such DD combinations produce a longer third complementarity determining region (CDR3) than is found in other TCR or antibody molecules.

As the CDR3 in the various receptor chains is essentially composed of the regions between the $V(D)J$ segments, where junctional diversity mechanisms can introduce a very high degree of amino acid variability, one can see why it is that this

Germline DNA	Recombined DNA	Protein sequence
V_α J_α CCC CCC TGG		
CCC CCC TGG	CCC TGG	- Pro.Trp -
CCC CCC TGG	CCC CGG	- Pro.Arg -
CCC CCC TGG	CCC CCG	- Pro.Pro -

Figure 4.12 Junctional diversity between a TCR V_α and J_α germline segment producing three variant protein sequences.

The nucleotide triplet that is spliced out is colored the darker blue. For TCR β chain and Ig heavy chain genes junctional diversity can apply to V , D , and J segments.

hypervariable loop usually contributes the most to determining the fine antigen-binding specificity of these molecules.

Receptor editing

Recent observations have established that lymphocytes are not necessarily stuck with the antigen receptor they initially make: if they don't like it they can change it. The replacement of an undesired receptor with one that has more acceptable characteristics is referred to as *receptor editing*. This process has been described for both immunoglobulins and for TCR, allowing the replacement of either nonfunctional rearrangements or autoreactive specificities. Furthermore, receptor editing in the periphery may rescue low-affinity B-cells from apoptotic cell death by replacing a low-affinity receptor with a selectable one of higher affinity. That this does indeed occur in the periphery is strongly supported by the finding that mature B-cells in germinal centers can express RAG-1 and RAG-2 that mediate the rearrangement process.

But how does this receptor editing work? Well, in the case of the receptor chains that lack *D* gene segments, namely the immunoglobulin light chain and the TCR α chain, a secondary rearrangement may occur by a *V* gene segment upstream of the

previously rearranged *VJ* segment recombining to a 3' *J* gene sequence, both of these segments having intact RSSs that are compatible (Figure 4.13a). However, for immunoglobulin heavy chains and TCR β chains the process of *VDJ* rearrangement

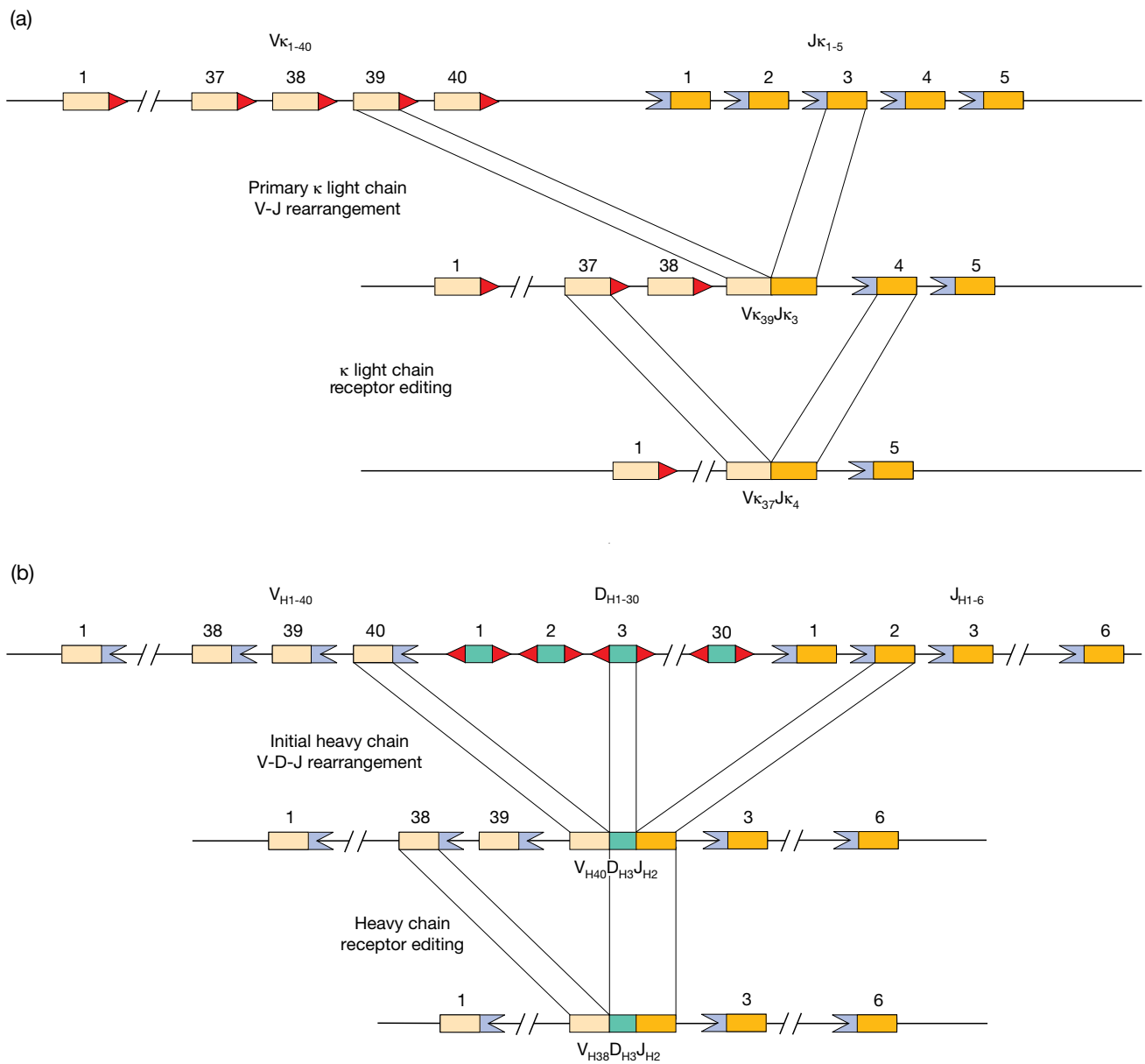


Figure 4.13 Receptor editing. (a) For immunoglobulin light chain or TCR α chain the recombination signal sequences (RSSs; heptamer–nonamer motifs) at the 3' end of each variable (*V*) segment and the 5' of each joining (*J*) segment are compatible with each other and therefore an entirely new rearrangement can potentially occur as shown. This would result in a receptor with a different light chain variable sequence (in this example $V_{\kappa_{37}}J_{\kappa_4}$ replacing $V_{\kappa_{39}}J_{\kappa_3}$) together with the original heavy chain. (b) With respect to the immunoglobulin heavy chain or TCR β chain the organization of the heptamer–nonamer sequences in the RSS precludes a *V* segment directly recombining with the *J* segment. This is the so-called 12/23 rule whereby the heptamer–nonamer sequences associated with a 23 base-pair spacer (colored violet) can only base-pair with heptamer–nonamer sequences containing a 12 base-pair spacer (colored red). The heavy chain *V* and *J* both have an RSS with a 23 base-pair spacer and so this is a nonstarter. Furthermore, all the unrearranged *D* segments have been deleted so that there are no 12 base-pair spacers remaining. This apparent barrier to secondary rearrangement is probably overcome by the presence of an RSS-like sequence near the 3' end of the *V* gene coding sequences, so that only the *V* gene segment is replaced (in the example shown, the sequence $V_{H38}D_{H3}J_{H2}$ replaces $V_{H40}D_{H3}J_{H2}$).

deletes all of the *D* segment-associated RSSs (Figure 4.13b). Because V_H and J_H both have 23 base-pair spacers in their RSSs, they cannot recombine: that would break the 12/23 rule. This apparent obstacle to receptor editing of these chains may be overcome by the presence of a sequence near the 3' end of the *V* coding sequences that can function as a surrogate RSS, such that the new *V* segment would simply replace the previously rearranged *V*, maintaining the same *D* and *J* sequence (Figure 4.13b). This is probably a relatively inefficient process and receptor editing may therefore occur more readily in immunoglobulin light chains and TCR α chains than in immunoglobulin heavy chains and TCR β chains. Indeed, it has been suggested that the TCR α chain may undergo a series of rearrangements, continuously deleting previously functionally rearranged *VJ* segments until a selectable TCR is produced.

Recognition of the correct genomic regions by the RAG recombinase

A question that is only now being resolved is how the RAG-1/RAG-2 recombinase selects the correct genomic regions to target for recombination. Clearly it would be disastrous were this complex able to access all DNA, randomly leaving double-stranded breaks in its wake. One mechanism of protection is to induce RAG expression only where and when it is needed, but this does not explain how the RAG complex is targeted only to Ig and TCR loci in the cells in which it is expressed. This puzzle is explained by observations suggesting that **alterations to histones** – the proteins upon which DNA is packaged – flag particular loci for binding of the RAG complex. Recent studies have shown that histone H3 that has been modified by trimethylation on lysine at position 4 (H3K4me3) acts as a binding site for RAG-2. Thus, genomic regions that are poised for VDJ recombination are located close to H3K4me3 histone “marks.” Consistent with this idea, experimental ablation of H3K4me3 marks results in greatly impaired V(D)J recombination. But the H3K4me3 mark is found at many more sites throughout the genome than there are antigen receptor loci, so how does the RAG-1/RAG-2 complex find the correct sites? The answer seems to be that the specificity of RAG-1 for RSS sites, combined with that of RAG-2 for H3K4me3 chromatin marks, may act as a clamp that guides the recombinase to the right locations. Binding of the RAG complex to the H3K4me3 mark may also activate the recombinase activity of RAG-1 through an allosteric mechanism, increasing the catalytic activity of the complex when it has been positioned at the correct location.

Interchain amplification

The immune system took an ingenious step forward when two different types of chain were utilized for the recognition molecules because the combination produces not only a larger combining site with potentially greater affinity, but also new variability. Heavy–light chain pairing among immunoglobulins

appears to be largely random and therefore two B-cells can employ the same heavy chain but different light chains. This route to producing antibodies of differing specificity is easily seen *in vitro* where shuffling different recombinant light chains against the same heavy chain can be used to either fine-tune, or sometimes even alter, the specificity of the final antibody. In general, the available evidence suggests that *in vivo* the major contribution to diversity and specificity comes from the heavy chain, perhaps not unrelated to the fact that the heavy chain CDR3 gets off to a head start in the race for diversity being, as it is, encoded by the junctions between three gene segments: *V*, *D*, and *J*.

This random association between TCR γ and δ chains, TCR α and β chains, and Ig heavy and light chains yields a further geometric increase in diversity. From Table 4.2 it can be seen that approximately 230 functional TCR and 153 functional Ig germline segments can give rise to 4.5 million and 2.3 million different combinations, respectively, by straightforward associations *without* taking into account all of the fancy junctional mechanisms described above. Hats off to evolution!

Somatic hypermutation

As discussed in Chapter 3, there is inescapable evidence that immunoglobulin *V*-region genes can undergo significant **somatic hypermutation**. Analysis of 18 murine λ myelomas revealed 12 with identical structure, four showing just one amino acid change, one with two changes and one with four changes, all within the hypervariable regions and indicative of somatic hypermutation of the single mouse λ germline gene. In another study, following immunization with pneumococcal antigen, a single germline T15 V_H gene gave rise by mutation to several different V_H genes all encoding phosphorylcholine antibodies (Figure 4.14).

A number of features of this somatic diversification phenomenon are worth revisiting. The mutations are the result of single nucleotide substitutions, they are restricted to the variable as distinct from the constant region and occur in both framework and hypervariable regions. The mutation rate is remarkably high, approximately 1×10^{-3} per base-pair per generation, which is approximately a million times higher than for other mammalian genes. In addition, the mutational mechanism is bound up in some way with class switch recombination as the enzyme **activation-induced cytidine deaminase (AID)** is required for both processes and hypermutation is more frequent in IgG and IgA than in IgM antibodies, affecting both heavy (Figure 4.14) and light chains. However, V_H genes are, on average more mutated than V_L genes. This might be a consequence of receptor editing acting more frequently on light chains, as this would have the effect of wiping the slate clean with respect to light chain *V* gene mutations while maintaining already accumulated heavy chain *V* gene point mutations.

As we outlined in Chapter 3, AID initiates both class switch recombination as well as somatic hypermutation through

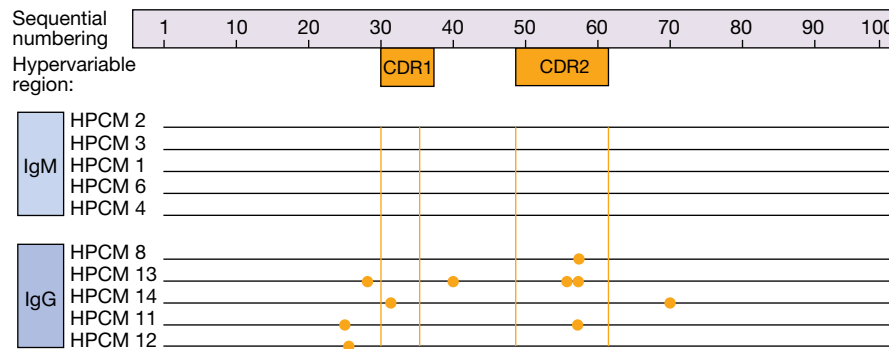


Figure 4.14 Mutations in a germline gene. The amino acid sequences of the V_H regions of five IgM and five IgG monoclonal phosphorylcholine antibodies generated during an antipneumococcal response in a single mouse are compared with the primary structure of the T15 germline sequence. A line indicates identity with the T15 prototype and an orange circle a single amino acid difference. Mutations have only occurred in the IgG molecules and are seen in both hypervariable and framework segments. (After Gearhart P.J. (1982) *Immunology Today* 3, 107.) Although in some other studies somatic hypermutation has been seen in IgM antibodies, the amount of mutation usually greatly increases following class switching.

deaminating deoxycytidine within certain DNA hotspots that are characterized by the presence of WRC sequences (W = A or T, R = purine, and C is the deoxycytidine that becomes deaminated). Although the target of AID was initially thought to be RNA, more recent evidence suggests that this enzyme works directly on DNA, although RNA editing is not ruled out. Deamination of deoxycytidine changes this base to a deoxyuracil that would normally be repaired by mismatch repair enzymes but, for reasons that are not yet fully understood, can result in removal of the mismatched uracil that generates a gap that is filled in by an error-prone polymerase to generate a point mutation at this position and can also mutate surrounding bases. It remains unclear how AID is targeted to the correct locations within V regions of rearranged Ig genes, to ensure that mutations are not inadvertently introduced at other loci, but similar to the RAG recombinase, this might involve specific histone modifications. Hyperacetylated versions of histones H3 and H4 appear to be more abundant in mutating V regions than in the C regions of Ig genes. This observation, coupled with observations that AID is recruited to actively transcribing Ig genes by proteins that bind to CAGGTG sequences found in all Ig transcriptional enhancers, suggests a possible mechanism. Thus, the combination of the CAGGTG sequence motif, coupled with the modified histones discussed above, may position AID at the correct locations from which to operate.

Somatic hypermutation does not appear to add significantly to the repertoire available in the early phases of the primary response, but occurs during the generation of memory and is responsible for tuning the response towards higher affinity.

Recently, data have been put forward suggesting that there is yet another mechanism for creating further diversity. This involves the insertion or deletion of short stretches of nucleotides within the immunoglobulin V gene sequence of both heavy and light chains. This mechanism would have an

intermediate effect on antigen recognition, being more dramatic than single point mutation, but considerably more subtle than receptor editing. In one study, a reverse transcriptase-polymerase chain reaction (RT-PCR) was employed to amplify the expressed V_H and V_L genes from 365 IgG⁺ B-cells and it was shown that 6.5% of the cells contained nucleotide insertions or deletions. The transcripts were left in-frame and no stop codons were introduced by these modifications. The percentage of cells containing these alterations is likely to be an underestimate. All the insertions and deletions were in, or near to, CDR1 and/or CDR2. N-region diversity of the CDR3 meant that it was not possible to analyze the third hypervariable region for insertions/deletions of this type and therefore these would be missed in the analysis. The fact that the alterations were associated with CDRs does suggest that the B-cells had been subjected to selection by antigen. It was also notable that the insertions/deletions occurred at known hotspots for somatic point mutation, and the same error-prone DNA polymerase responsible for somatic hypermutation may also be involved here. The sequences were often a duplication of an adjacent sequence in the case of insertions or a deletion of a known repeated sequence. This type of modification may, like receptor editing, play a major role in eliminating autoreactivity and also in enhancing antibody affinity.

T-cell receptor genes, on the other hand, **do not generally undergo somatic hypermutation**. It has been argued that this would be a useful safety measure as T-cells are positively selected in the thymus for weak reactions with self MHC, so that mutations could readily lead to the emergence of high-affinity autoreactive receptors and autoimmunity.

One may ask how it is that this array of germline genes is protected from genetic drift. With a library of 390 or so functional V, D, and J genes, selection would act only weakly on any single gene that had been functionally crippled by mutation and this implies that a major part of the library could be lost before evolutionary forces operated. One idea is that each

subfamily of related V genes contains a prototype coding for an antibody indispensable for protection against some common pathogen, so that mutation in this gene would put the host at a disadvantage and would therefore be selected against. If any of the other closely related genes in its set became defective through mutation, this indispensable gene could repair them by gene conversion, a mechanism in which two genes interact in such a way that the nucleotide sequence of part or all of one becomes identical to that of the other. Although gene conversion has been invoked to account for the diversification of MHC genes, it can also act on other families of genes to maintain a degree of sequence homogeneity. Certainly it is used extensively by, for example, chickens and rabbits, in order to generate immunoglobulin diversity. In the rabbit only a single germline V_H gene is rearranged in the majority of B-cells; this then becomes a substrate for gene conversion by one of the large number of V_H pseudogenes. There are also large numbers of V_H pseudogenes and orphan genes (genes located outside the gene locus, often on a completely different chromosome) in humans that actually outnumber the functional genes, although there is no evidence to date that these are used in gene conversion processes.

Invariant natural killer T-cell receptors bridge innate and adaptive immunity

The highly variable nature of the TCR confers on the conventional T-cell population the ability to respond to an immense array of different antigens, with individual T-cells specific for a single antigen. Invariant natural killer T-cells (iNKT) are a unique subset of T-cells that display a semi-variant TCR that equips individual iNKT cells with the ability to detect a broad array of microbial lipid antigens, presented on CD1d antigen-presenting molecules on antigen-presenting cells (APCs). Although conventional T-cells are activated by APCs that have first been activated by microbial antigen (in a process that takes some time), iNKTs can respond directly to PAMPs, secreting cytokines and presenting co-stimulatory molecules in a manner more reminiscent of innate immune cell PRR activation than T-cell stimulation.

Although conventional $CD4^+$ T-cells provide help to B-cells as part of an adaptive immune response, iNKTs are unique in that they can provide help to B-cells in an innate and adaptive manner, with differing outcomes. iNKTs that are activated by antigen presented on B-cell C1d can directly license B-cell activation in a cognate, innate-like manner, through co-stimulation with CD40L and the production of various cytokines, such as IFN γ and IL-21. This leads to a restricted form of B-cell activation, with plasmablast expansion, early germinal center development, modest affinity maturation, and primary class-switched antibody production, but lacking the development of plasma cells and B-cell memory responses. Alternatively, iNKTs that have been activated by DCs presenting antigen can drive full B-cell activation in a noncognate, or adaptive fashion, by enlisting the help of $CD4^+$ T-cells to license B-cells,

driving the generation of mature germinal centers, robust affinity maturation, the development of antibody-producing plasma cells, and a B-cell memory response.

Antigen binding by iNKT receptors

Similar to conventional T-cells, the TCR of iNKTs consists of an α and β chain, with each chain divided into a constant (C) and variable (V) region, with the variable regions conferring ligand diversity. The variable domain of the TCR α chain is split into V and J regions, whereas the β chain is encoded by V, D, and J domains (Figure 4.15). **Three complementarity determining regions (CDRs)** are situated within the V domains of both α and β chains and these regions generate the antigen-binding site of the receptor (Figure 4.15).

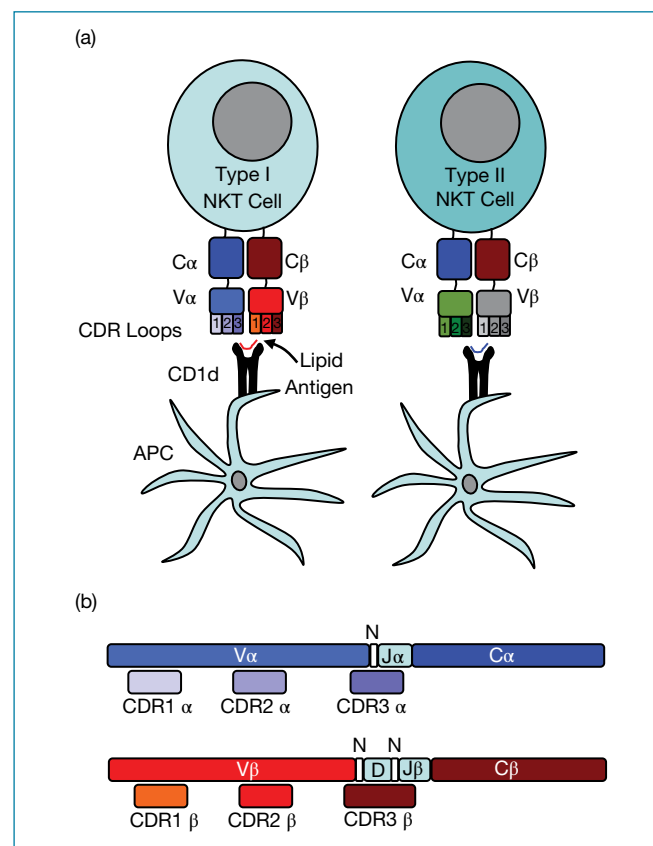


Figure 4.15 Natural killer T-cells. (a) Schematic representation of type I and type II natural killer T (NKT) cells. These two subsets use different variable (V) region gene segments in the α and β chains of their T-cell receptors (TCRs), and they recognize different CD1d-restricted antigens. (b) The $\alpha\beta$ TCR is composed of two chains, with the V domains containing the complementarity determining region (CDR) loops. The CDR3 loops are encoded by multiple gene segments and also contain nontemplated (N) regions, which add further diversity to the TCR repertoire. The color coding is the same as that used for the type I NKT TCR in (a). APC, antigen-presenting cell; C, constant; D, diversity; J, joining. (Reproduced with permission from the authors Rossjohn *et al.*, (2012) *Nature Reviews Immunology* 12, 845–857 © Nature Publishing Group.)

There are two main subsets of iNKT cells, type I and type II iNKT, with ligand binding by type I TCRs exhibiting characteristics of innate PRRs, whereas type II iNKT receptors share some similarity with conventional TCRs. Type I cells possess a semi-invariant TCR α chain (V α 24 J α 18), combined with a restricted β chain which utilizes V β 11. The CD3 α loop plays a particularly important role for type I NKT as deletion of this region in mice greatly impairs ligand binding. A defining characteristic of type I iNKT over type II cells is their ability to detect CD1d-bound α -galactosylceramide (α GalCer), a glycolipid originally isolated from the marine sponge *Agelas mauritianus* and more recently shown to be a component of *Bacteroides* bacteria which inhabit the human gut. CD1d binding of α GalCer is typical of other α -linked glycolipids, with the hydrophobic portion of the ligand buried in the two main binding regions of CD1d, the A' and F' pockets, while the polar region is exposed to solvent.

Binding of ligand by type I TCR is a relatively rigid affair, regardless of the nature of the ligand, and is dominated by germline-encoded regions in the semi-variant α chain, with assistance from β chain motifs. The type I iNKT TCR positions itself parallel, above the F' pocket of CD1d, in a manner similar to innate-like PRRs, with the β chain CDR2 β binding a region above the F' pocket. The α GalCer is bound directly by the CDR1 α loop and bridging of both CD1d and α GalCer by the CDR3 α loop stabilizes the interaction (Figure 4.16). The importance of the CDR2 β and CDR3 α loops to ligand binding is illustrated by severely reduced ligand binding in receptors bearing mutations to critical residues in these regions. Many microbial ligands have been demonstrated for type I iNKT cells, including α -glucosyldiacylglycerols from *Streptococcus pneumoniae* and α -galactosyldiacylglycerols from *Borrelia burgdorferi*. As with α GalCer, the α -glycosidic linkages in these ligands betray

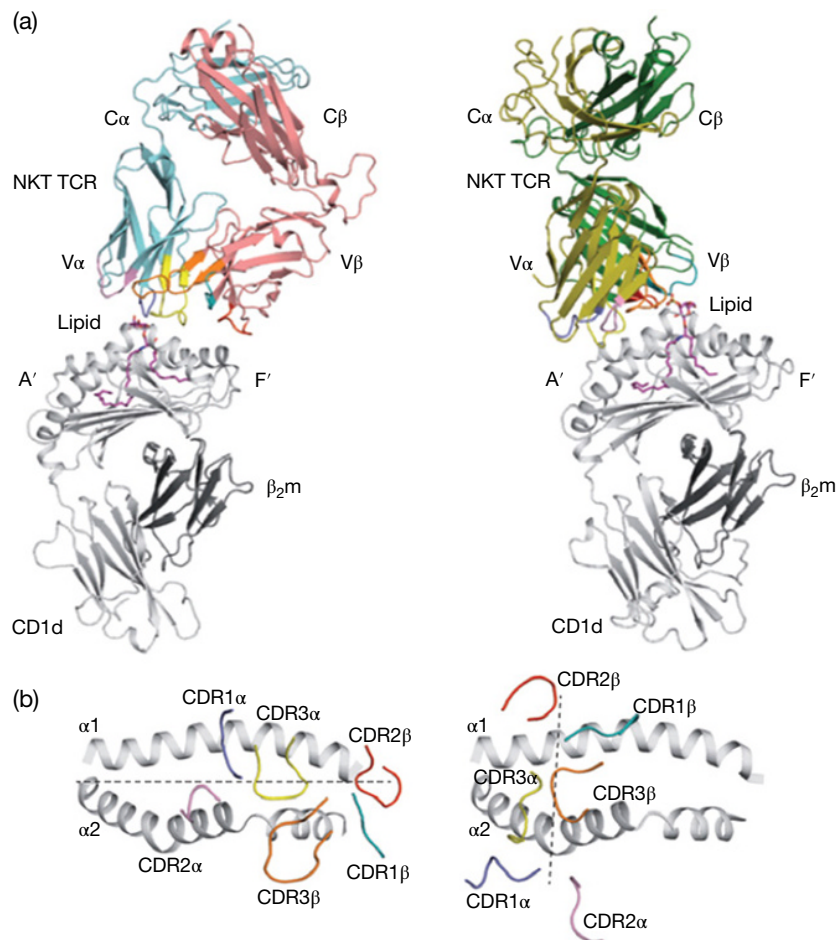


Figure 4.16 Structural comparison between type I and type II NKT TCR–lipid–CD1d complexes. (a) The figure shows the docking mode of the T-cell receptor (TCR) in a type I natural killer T (NKT) cell TCR–lipid–CD1d complex (left) and a type II NKT TCR–lipid–CD1d complex (right). The CD1d antigen-binding pockets are labelled A' and F'. (b) The figure shows the view looking down into the antigen-binding groove of the two complexes showing the parallel docking mode in the type I NKT–lipid–CD1d complex (left), and the orthogonal docking mode in the type II NKT–lipid–CD1d complex (right). Dashed lines represent the docking mode. β_2m , β_2 -microglobulin. (Reproduced with permission from the authors Rossjohn *et al.*, (2012) *Nature Reviews Immunology* **12**, 845–857 © Nature Publishing Group.)

their microbial origin as mammalian glycolipids have mainly β -glycosidic linkages.

Type II iNKT cells do not respond to α -glycolipids such as α GalCer, however, type II receptors possess a more varied, oligoclonal repertoire than type I cells that share features of both conventional and innate-like T-cells. Type II iNKT specific for the self glycolipid antigen sulfatide have been found to play a role in the regulation of various autoimmune disorders, including concanavalin A-induced hepatitis (a mouse model of human autoimmune hepatitis) and type 1 diabetes. The crystal structure of the type II V α 1J α 26–V β 16J β 2.1 TCR bound to CD1d/sulfatide shows that, in contrast to the type I receptor, where innate-like germline-encoded regions confer specificity, non-germline-encoded regions, more similar to conventional TCRs, dominate type II iNKT ligand binding (Figure 4.16). Although the type I receptor is orientated above the CD1d F' pocket, the type II TCR is positioned above the A' pocket with both the α and β chains making contact with CD1d in a diagonal orientation, similar to MHC–TCR interactions. Additionally, the CDR3 β loop of the type II receptor determines specificity for sulfatide while the α chain of the type I TCR interacts with ligand. The more diverse nature of type II TCR binding is thought to confer on type II iNKT cells the ability to respond to a more varied range of antigens, including sulfatides and other glycolipids, phospholipids, and nonlipid antigens. The ability of type I and II iNKT TCRs to bind CD1d-presented antigen in mechanistically distinct ways illustrates the impressive nature of mammalian immune systems in responding to a varied range of pathogen products.

NK receptors

Natural killer (NK) cells are a population of leukocytes that, like T- and B-cells, employ receptors that can provoke their activation, the consequences of which are the secretion of cytokines, most notably IFN γ , and the delivery of signals to their target cells via Fas ligand or cytotoxic granules that are capable of killing the cell that provided the activation signal (Figure 1.40 and Figure 1.41; see also Videoclip 3). However, in addition to **activating NK receptors**, NK cells also possess receptors that can inhibit their function. As we shall see, **inhibitory NK cell receptors** are critical to the correct functioning of these cells as these receptors are what prevent NK cells from indiscriminately attacking healthy host tissue. Let us dwell on this for a moment because this is quite a different set-up to the one that prevails with T- and B-cells. A T- or B-lymphocyte has a single type of receptor that either recognizes antigen or it doesn't. NK cells have two types of receptor: activating receptors that trigger cytotoxic activity upon recognition of ligands that should not be present on the target cell, and inhibitory receptors that restrain NK killing by recognizing ligands that ought to be present. Thus, NK cell killing can be triggered by two different situations: either the appearance of ligands for the activating receptors or the disappearance of ligands for the inhibitory receptors. Of course, both things can happen at once, but one is sufficient.

We have already discussed NK cell-mediated killing in some detail in Chapter 1, here we will focus on how these cells select their targets as a consequence of alterations to the normal pattern of expression of cell surface molecules, such as **classical MHC class I** molecules, that can occur during viral infection. NK cells can also attack cells that have normal expression levels of classical MHC class I but have upregulated **nonclassical MHC class I**-related molecules because of cell stress or DNA damage.

NK cells express diverse “hard-wired” receptors

Unlike the antigen receptors of T- and B-lymphocytes, NK receptors are “hard-wired” and do not undergo V(D)J recombination to generate diversity. As a consequence, NK cell receptor diversity is achieved through gene duplication and divergence and, in this respect, resembles the pattern recognition receptors we discussed in Chapter 1. Thus, NK receptors are a somewhat confusing ragbag of structurally disparate molecules that share the common functional property of being able to survey cells for normal patterns of expression of MHC and MHC-related molecules. NK cells, unlike $\alpha\beta$ T-cells, are not **MHC-restricted** in the sense that they do not see antigen only when presented within the groove of MHC class I or MHC class II molecules. On the contrary, one of the main functions of NK cells is to patrol the body looking for cells that have lost expression of the normally ubiquitous classical MHC class I molecules; a situation that is known as **“missing-self” recognition** (Figure 4.17). Such abnormal cells are usually either malignant or infected with a microorganism that interferes with class I expression.

We saw in Chapter 1 that many pathogens activate PRRs such as Toll-like receptors that induce transcription of interferon-regulated factors, which subsequently direct the transcription of type I interferons (IFN α and IFN β). PRRs, such as TLR3, TLR7–9 and the RIG-like helicases, that reside within intracellular compartments are particularly attuned to inducing the expression of type I interferons (see Figure 1.16). Such PRRs typically detect long single- or double-stranded RNA molecules that are characteristically produced by many viruses. One of the downstream consequences of interferon secretion is the cessation of protein synthesis and consequent downregulation of, among other things, MHC class I molecules. Thus, detection of PAMPs from intracellular viruses or other intracellular pathogens can render such cells vulnerable to NK cell-mediated attack. Which is exactly the point? Many intracellular pathogens also directly interfere with the expression or surface exposure of MHC class I molecules as a strategy to evade detection by CD8⁺ T-cells that survey such molecules for the presence of nonself peptides.

Because of the central role that MHC class I molecules play in presenting peptides derived from intracellular pathogens to the immune system, it is relatively easy to understand why these molecules may attract the unwelcome attentions of viruses or other uninvited guests planning to gatecrash their cellular hosts. It is probably for this reason that NK cells co-evolved alongside MHC-restricted T-cells to ensure that



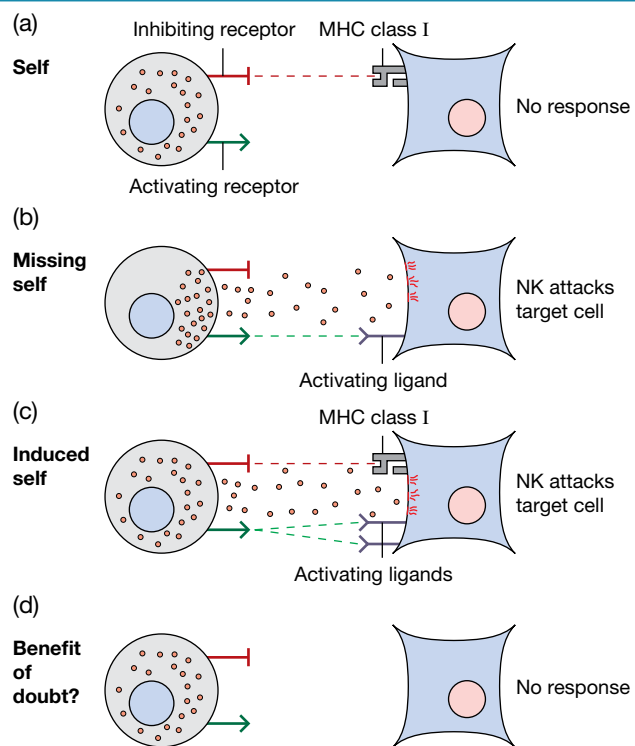


Figure 4.17 Natural killer (NK) cell-mediated killing and the "missing-self" hypothesis. (a) Upon encounter with a normal autologous MHC class I-expressing cell, NK inhibitory receptors are engaged and activating NK receptors remain unoccupied because no activating ligands are expressed on the target cell. The NK cell does not become activated in this situation. (b) Loss of MHC class I expression ("missing-self"), as well as expression of one or more ligands for activating NK receptors, provokes NK-mediated attack of the cell via NK cytotoxic granules. (c) Upon encountering a target cell expressing MHC class I, but also expressing one or more ligands for activating NK receptors ("induced-self"), the outcome will be determined by the relative strength of the inhibitory and activating signals received by the NK cell. (d) In some cases, cells may not express MHC class I molecules or activating ligands and may be ignored by NK cells, possibly owing to expression of alternative ligands for inhibitory NK receptors.

pathogens, or other conditions that may interfere with MHC class I expression and hence antigen presentation to $\alpha\beta$ T-cells, are given short shrift. Cells that end up in this unfortunate position are likely to soon find themselves looking down the barrel of an activated NK cell. Such an encounter typically results in death of the errant cell as a result of attack by cytotoxic granules containing a battery of proteases and other destructive enzymes released by the activated NK cell.

NK receptors can be activating or inhibitory

NK cells play an important role in the ongoing battle against viral infection and tumor development and carry out their task using two sets of receptors: activating receptors, which recognize

molecules that are upregulated on stressed or infected cells, and inhibitory receptors that recognize MHC class I molecules or MHC-related molecules that monitor the correct expression of classical MHC class I molecules. It is the balance between inhibitory and activating stimuli that will dictate whether NK-mediated killing will occur (Figure 4.17).

Several structurally distinct families of NK receptors have been identified: including the *C-type lectin receptors (CTLRs)* and the *Ig-like receptors*. Both receptor types include inhibitory and activating receptors (Table 4.3). Those that are inhibitory contain *ITIMs (immunoreceptor tyrosine-based inhibitory motifs)* within their cytoplasmic tails that exert an inhibitory function within the cell by recruiting phosphatases, such as *SHP-1*, that can antagonize signal transduction events that would otherwise lead to release of NK cytotoxic granules or cytokines (Figure 4.17). Activating receptors, on the other hand, are associated with accessory proteins, such as *DAP-12*, that contain positively acting ITAMs within their cytoplasmic tails that can promote events leading to NK-mediated attack. Upon engagement with their cognate ligands (MHC class I molecules), inhibitory receptors suppress signals that would otherwise lead to NK cell activation. Cells that lack MHC class I molecules are therefore unable to engage the inhibitory receptors and are likely to suffer the consequences (Figure 4.18).

NK receptors are highly diverse and, as this is an area of active investigation, we will make some necessary generalizations.

Ly49 receptors

The main class of MHC class I-monitoring receptors in the mouse is represented by the Ly49 multigene family of receptors, which contains approximately 23 distinct genes: Ly49A to W. These receptors are expressed as disulfide-linked homodimers, with each monomer composed of a C-type lectin domain connected to the cell membrane via an α -helical stalk of ~ 40 amino acids (Figure 4.18a). Each NK cell expresses from one to four different Ly49 genes. Individual Ly49 receptors recognize MHC class I molecules in a manner that is, in most cases, independent of bound peptide. Ly49 dimers make contact with MHC class I molecules at two distinct sites that do not significantly overlap with the TCR-binding area on the MHC (Figure 4.18e).

Killer immunoglobulin-like receptors

Rather remarkably, humans do not use Ly49-based receptors to carry out the same task, but instead employ a functionally equivalent, but structurally distinct, set of receptors for this purpose, the *killer immunoglobulin-like receptors (KIRs)* (Figure 4.18c,d). This is a good example of *convergent evolution*, where unrelated genes have evolved to fulfill the same functional role. By contrast with the mode of binding to MHC displayed by the Ly49 receptors, the KIRs make contact with MHC class I molecules in an orientation that resembles the docking mode of the TCR, where contact with bound peptide

Table 4.3 Natural killer (NK) activating and inhibitory receptors in humans. This table is not exhaustive as some receptors have not been included. Note that the killer immunoglobulin-like receptor (KIR) family is not utilized in the mouse, instead numerous Ly49 family receptors are present.

Family	Receptor	Ligand	Function
KIR	KIR2DL1	Group 2 HLA-C	Inhibitory
	KIR2DL2/3	Group 1 HLA-C	Inhibitory
	KIR2DL5	Unknown	Inhibitory
	KIR3DL1	Bw4, HLA-B	Inhibitory
	KIR3DL2	HLA-A3/HLA-A11	Inhibitory
	KIR2DS1	Group 2 HLA-C	Activating
	KIR2DS2	Group 1 HLA-C	Activating
	KIR3DS1	Bw4, HLA-B	Activating
	KIR2DS3	Unknown	Activating
	KIR2DS4	HLA-Cw4	Activating
	KIR2DS5	Unknown	Activating
	KIR2DL4	HLA-G	Activating
C-type lectin	CD94:NKG2A	HLA-E	Inhibitory
	NKR-P1A	LLT1	Inhibitory
	CD94:NKG2C	HLA-E	Activating
	CD94:NKG2E	HLA-E	Activating
	NKG2D	MICA, MICB, ULBP	Activating
Natural cytotoxicity	NKp30	BAT-3	Activating
	NKp44	Viral hemagglutinin	Activating
	NKp48	Viral hemagglutinin	Activating
Others	CD18	IgG	Activating
	ILT2	HLA-A, B, C, G	Inhibitory

is part of the interaction. However, it is worth emphasizing that although KIRs do make contact with peptide within the MHC class I groove, these receptors do not distinguish between self and nonself peptides as TCRs do.

CD94/NKG2 receptors

NK cells also use members of the *CD94/NKG2 family*, which belong to the CTLR class of receptor, that are present in human, rat, and mouse genomes. CD94/NKG2A heterodimers, which are inhibitory receptors, can indirectly monitor the expression of MHC class I proteins by interacting with an invariant MHC-related molecule called HLA-E (human) and Qa-1 (mouse), the surface expression of which is dependent on the proper synthesis of the main MHC class I A, B, and C proteins as will be discussed in more detail below. If normal levels of HLA-E are detected, the inhibitory receptors will suppress NK attack. CD94/NKG2 heterodimers are expressed on most NK cells as well as $\gamma\delta$ T-cells.

This receptor system indirectly monitors the expression of MHC class I molecules in a rather ingenious way. The MHC class I-related molecules HLA-E/Qa-1 are notable for the fact that they mainly bind invariant peptides that are found in the leader sequences (amino acids 3–11) of the classical MHC class I A, B, and C molecules. In the absence of the leader sequences from these peptides, HLA-E and Qa-1 are not expressed on the cell surface, thereby triggering NK attack. Because many

microbial agents, particularly viruses, antagonize the expression of MHC class I molecules, monitoring the expression level of such molecules is a neat way of indirectly detecting that all is not well.

Another member of this receptor family, NKG2D, does not associate with CD94 and instead forms NKG2D/NKG2D homodimers, which are activating receptors. NKG2D homodimers recognize the MHC-related proteins, *MHC class I chain-related A chain (MICA)* and the related *MICB*, as well as UL16-binding proteins in human and the homologous H60/RAE-1/MULT-1 proteins in mice. These ligands become upregulated in damaged or stressed cells as will be elaborated upon later.

Natural cytotoxicity receptors

Additional NK receptors that belong to the Ig-like class are the *natural cytotoxicity receptors*, which include NKp30, NKp44, and NKp46, all of which are activating receptors. The ligands for these receptors remain unclear but there is some evidence that they can detect certain viral products, such as hemagglutinin of influenza virus or Sendai virus and may also be sensitive to altered patterns of heparan sulfate on the surfaces of tumors. BAT-3 (HLA-B associated transcript-3), a protein that has been implicated in DNA damage response pathways, has also recently been suggested to be a ligand for NKp30.

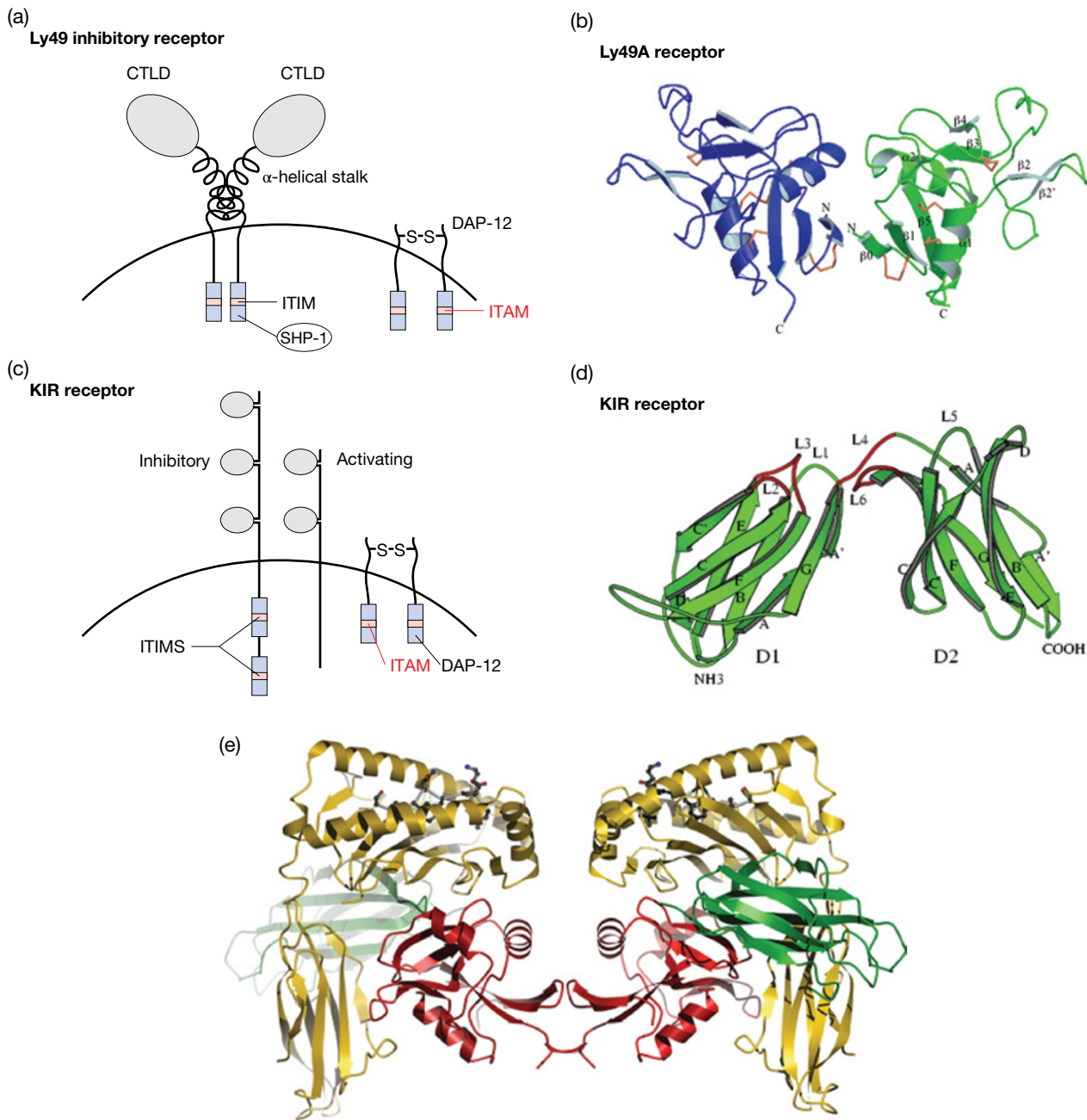


Figure 4.18 NK receptors. (a) Schematic representation of an inhibitory Ly49 receptor dimer composed of two C-type lectin domains (CTLDs). The cytoplasmic tails of inhibitory Ly49 receptors contain immunoreceptor tyrosine-based inhibitory motifs (ITIMs) that can recruit phosphatases, such as SHP-1, capable of antagonizing NK activation. Activating Ly49 receptors lack ITIMs and can associate with ITAM-containing accessory proteins such as DAP-12 that can promote NK cell activation. (b) C-type lectin-like domain of the Ly49 NK cell receptors. The three-dimensional structure shown is the dimeric Ly49A (Protein Data Bank entry code 1Q03), the monomer A is colored blue and the monomer B is colored green. For clarity, secondary structural elements α -helices, β -strands, disulfide bonds and N and C termini are labeled only on one monomer. (Source: Dr. Nazzareno Dimasi. Reproduced with permission.) (c) The human KIRs (killer immunoglobulin-like receptors) are functionally equivalent to the murine Ly49 receptors but remain structurally distinct. These receptors contain two or three Ig-like extracellular domains and can also be inhibitory or activating depending on the presence of an ITIM motif in their cytoplasmic domains, as shown. Activating receptors can associate with the ITAM-bearing DAP-12 accessory complex to propagate activating signals into the NK cell that result in NK-mediated attack. (d) Structure of the extracellular Ig-like domains (D1 and D2) of a KIR receptor. (Source: Dr Peter Sun. Reproduced with permission.) (e) Ribbon diagram of the crystal structure of the Ly49C/H-2K^b complex. Ly49C, the H-2K^b heavy chain, and β_2 -microglobulin (β_2 M) are shown in red, gold, and green, respectively. The MHC-bound peptide (gray) is drawn in ball-and-stick representation. (Source: Dr. Lu Deng and Professor Roy A. Mariuzza. Reproduced with permission.)

CD16 Fc receptors

Another example of an activating NK receptor is CD16, the low-affinity Fc receptor for IgG that is responsible for antibody-dependent cellular cytotoxicity (ADCC). In this case, the receptor ligand is IgG bound to antigen present on a target cell, which is clearly an abnormal situation.

Cell stress and DNA damage responses can activate NK cells

Cellular stress, such as heat shock, is also a matter for concern for cells of the immune system as this can also be caused by infection, or alternatively, such cells may be undergoing malignant transformation. The HLA-E/Qa-1 system, which as we discussed earlier is involved in monitoring the ongoing expression of MHC class I proteins, is also involved in attracting the attentions of NK cells in the context of cell stress. In response to diverse forms of cellular stress, heat-shock proteins such as HSP-60 are induced and peptides derived from the HSP-60 leader peptide can displace MHC class I-derived peptides from the HLA-E peptide-binding cleft. Although HLA-E/HSP-60 peptide complexes are trafficked to the cell surface, they are no longer recognized by CD94/NKG2 heterodimers, which results in NK activation due to “missing self.”

In addition to recognizing “missing-self,” NK cells also use their receptors to directly recognize pathogen components or nonclassical MHC class I-like proteins, such as MICA and MICB, which are normally poorly expressed on normal healthy cells. MICA, and related ligands, have a complex pattern of expression but are often upregulated on transformed or infected cells and this may be sufficient to activate NK receptors that are capable of delivering activating signals, a phenomenon that has been termed “*induced-self*” recognition (Figure 4.17). Upon ligation, the activating receptors signal the NK cell to kill the target cell and/or to secrete cytokines. The potentially anarchic situation in which the NK cells would attack all cells in the body is normally prevented because of the recognition of MHC class I by the inhibitory receptors. Thus, normal patterns of MHC class I expression suppress NK killing, whereas the presence of abnormal patterns of self molecules induce NK activation. It is the relative intensity of these signals that determines whether an attack will occur.

Recent studies also suggest that checkpoint kinases, such as Chk1, that are involved in the *DNA damage response* can induce expression of a variety of activating ligands for NKG2 receptors, when a cell is damaged by γ -irradiation, or after treatment with DNA-damaging drugs. This suggests that cells that have suffered DNA damage may, in addition to activating their DNA repair machinery, also upregulate NK receptor ligands to alert the immune system. This makes perfect sense, as such cells are dangerous as they have the potential to escape normal growth controls and form a tumor owing to faulty or incomplete DNA repair. Indeed, tumor surveillance is thought to be one of the major roles of NK cells, a topic we will revisit again in Chapter 16.

The major histocompatibility complex (MHC)

Molecules within this complex were originally defined by their ability to provoke vigorous rejection of grafts exchanged between different members of a species (Milestone 4.2). We have already referred to the necessity for antigens to be associated with class I or class II MHC molecules in order that they may be recognized by T-lymphocytes (Figure 4.8). How antigenic peptides are processed and selected for presentation within MHC molecules and how the TCR sees this complex are discussed in detail in Chapter 5, but let us run through the major points briefly here so that reader will appreciate why these molecules are of huge importance within the immune system.

MHC molecules assemble within the cell, where they associate with short peptide fragments derived either from proteins being made by the cell (MHC class I molecules bind to peptides derived from proteins being synthesized within the cell) or proteins that have been internalized by the cell through phagocytosis or pinocytosis (MHC class II molecules bind to peptides derived from proteins made external to the cell). There are some exceptions to these general rules, which we deal with in Chapter 5. We have already made the analogy that this process represents a type of “quality control” checking system where a fraction of proteins present in the cell at any given moment are presented to T-cells for inspection to ensure that none of these is derived from nonself. Of course, if a cell happens to harbor a nonself peptide, we want the immune system to know about this as quickly as possible, so that the appropriate course of action can be taken. Thus, MHC class I molecules display peptides that are either self, or that are being made by an intracellular virus or bacterium. MHC class II molecules display peptides that are either extracellular self proteins or proteins being made by extracellular microorganisms. The whole point is to enable a T-cell to inspect what is going on, antigenically speaking, within the cell.

As we shall see, MHC class I molecules serve an important role presenting peptides for inspection by CD8 T-cells that are mainly preoccupied with finding virally infected or “abnormal” cells to kill. Should a TCR-bearing CD8 T-cell recognize a class I MHC-peptide combination that is a good “fit” for its TCR, it will attack and kill that cell. MHC class II molecules, on the other hand, are not expressed on the general cell population but are restricted to cells of the immune system, such as DCs, that have an antigen-presenting function as we already outlined in Chapter 1. Upon recognition of an appropriate MHC class II-peptide combination by a CD4 T-cell, this will result in activation of the latter and maturation to an effector T-cell that can give help to B-cells to make antibody for example. Although this is an oversimplification, as we will learn in later chapters, please keep in mind the general idea that MHC class I and II molecules present peptides to CD8- and CD4-restricted T-cells, respectively, for the purposes of allowing these cells to determine whether they should become “activated”



Milestone 4.2 The major histocompatibility complex

Peter Gorer raised rabbit antisera to erythrocytes from pure strain mice (resulting from >20 brother–sister matings) and, by careful cross-absorption with red cells from different strains, he identified the strain-specific antigen II, now known as H-2 (Table M4.2.1).

He next showed that the rejection of an albino (A) tumor by black (C57) mice was closely linked to the presence of the antigen II (Table M4.2.2) and that tumor rejection was associated with the development of antibodies to this antigen.

Subsequently, George Snell introduced the term **histocompatibility (H)** antigen to describe antigens provoking graft rejection and demonstrated that, of all the potential H antigens, differences at the H-2 (i.e., antigen II) locus provoked the strongest graft rejection seen between various mouse strains. *Poco a poco*, the painstaking studies gradually uncovered a remarkably complicated situation. Far from representing a single gene locus, H-2 proved to be a large complex of multiple genes,

many of which were highly polymorphic, hence the term **major histocompatibility complex (MHC)**. The major components of the current genetic maps of the human HLA and mouse H-2 MHC are drawn in Figure M4.2.1 to give the reader an overall grasp of the complex make-up of this important region (to immunologists we mean! – presumably all highly transcribed regions are important to the host in some way).

Table M4.2.1 Identification of H-2 (antigen II).

Rabbit antiserum to:	Antigens detected on albino red cells		
	I	II	III
Albino (A)	+++	+++	++
Black (C57)	++	–	++

Table M4.2.2 Relationship of antigen II to tumor rejection.

Antigen II phenotype of recipient strain	Rejection of tumor inoculum (A strain) by:			
	Pure strain*		(A × C57) F1 backcross to C57**	
	–	+	–	+
Ag II +ve (A)	39	0	17 (19.3)	17 (19.5)
Ag II –ve (C57)	0	45	0	44 (39)

* A tumor inoculum derived from an A strain mouse and bearing antigen II is rejected by the C57 host (+ = rejection; – = acceptance).

** Offspring of A × C57 mating were backcrossed to the C57 parent and the resulting progeny tested for antigen II (Ag II) and their ability to reject the tumor. The figures in brackets are numbers expected if tumor growth is influenced by two dominant genes, one of which determines the presence of antigen II.

Human	MHC class	II			III				I			Chromosome 6
	HLA	DP	DQ	DR	C'	HSP	TNF	etc	B	C	A	
Mouse	MHC class	I	II		III				I		Chromosome 17	
	H-2	K	A	E	C'	HSP	TNF	etc	D	L		

Figure M4.2.1 Main genetic regions of the major histocompatibility complex (MHC).

and differentiate to effector cells. Let us now look at these molecules in greater detail.

Class I and class II molecules are membrane-bound heterodimers

MHC class I

Class I molecules consist of a heavy polypeptide chain of 44 kDa noncovalently linked to a smaller 12 kDa polypeptide called **β_2 -microglobulin**. The largest part of the heavy chain is organized into three globular domains (α_1 , α_2 , and α_3) that protrude from the cell surface, a hydrophobic section anchors the molecule in the membrane, and a short

hydrophilic sequence carries the C-terminus into the cytoplasm (Figure 4.19).

The solution of the crystal structure of a human class I molecule provided an exciting leap forwards in our understanding of MHC function. Both β_2 -microglobulin and the α_3 region resemble classic Ig domains in their folding pattern (see Figure 4.19c). However, the α_1 and α_2 domains, which are most distal to the membrane, form two extended α -helices above a floor created by strands held together in a β -pleated sheet, the whole forming an undeniable **groove** (Figure 4.19b,c). The appearance of these domains is so striking, we doubt whether the reader needs the help of gastronomic analogies such as “two sausages on a barbecue” to prevent any class I

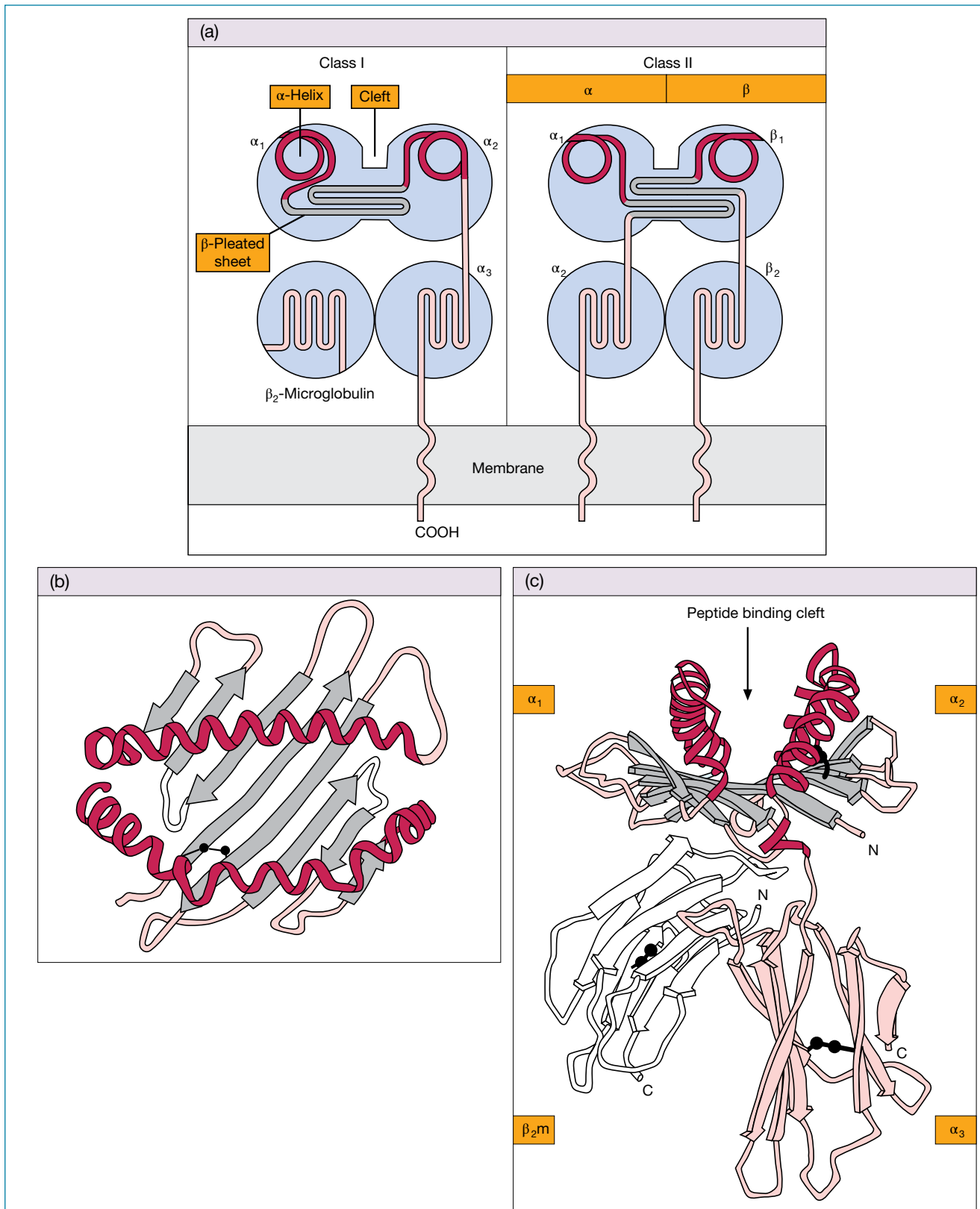


Figure 4.19 Class I and class II MHC molecules. (a) Diagram showing domains and transmembrane segments; the α -helices and β -sheets are viewed end on. (b) Schematic bird's eye representation of the top surface of human class I molecule (HLA-A2) based on the X-ray crystallographic structure. The strands making the β -pleated sheet are shown as thick gray arrows in the amino to carboxy direction; α -helices are represented as dark red helical ribbons. The inside-facing surfaces of the two helices and the upper surface of the β -sheet form a cleft. The two black spheres represent an intrachain disulfide bond. (c) Side view of the same molecule clearly showing the anatomy of the cleft and the typical Ig-type folding of the α_3 - and β_2 -microglobulin (β_2m) domains (four antiparallel β -strands on one face and three on the other). (Source: Bjorkman P.J. *et al.* (1987) *Nature* **329**, 506. Reproduced with permission of Nature Publishing Group.)

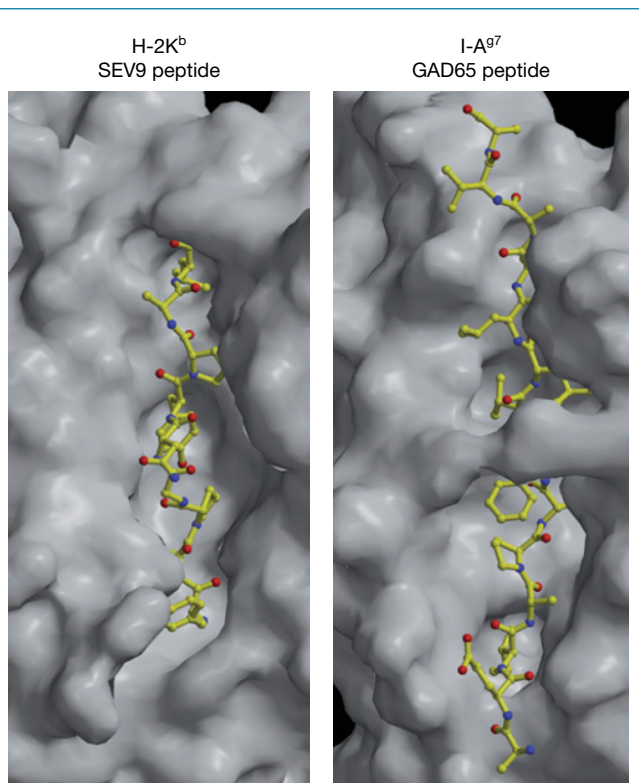


Figure 4.20 Surface view of mouse class I and class II MHC molecules in complex with peptide. Surface solvent-accessible areas of the mouse class I molecule (H-2K^b) in complex with a virus-derived peptide and the mouse class II molecule I-A^{g7} in complex with an endogenous peptide. The views shown here are similar to that schematically depicted in Figure 4.19b and look down upon the surface of the MHC molecules. Note that the peptide-binding cleft of class I molecules is more restricted than that of class II molecules, with the result that class I-binding peptides are typically shorter than those that bind to class II molecules. (Source: Dr. Robyn Stanfield and Dr. Ian Wilson, Department of Molecular Biology, The Scripps Research Institute, La Jolla, California, USA. Reproduced with permission.)

structural amnesia. Another curious feature emerged. The groove was occupied by a linear molecule, now known to be a peptide, which had co-crystallized with the class I protein (Figure 4.20).

MHC class II

Class II MHC molecules are also transmembrane glycoproteins, in this case consisting of α and β polypeptide chains of molecular weight 34 kDa and 29 kDa, respectively.

There is considerable sequence homology with class I, and structural studies have shown that the α_2 and β_2 domains, the ones nearest to the cell membrane, assume the characteristic Ig fold, while the α_1 and β_1 domains mimic the class I α_1 and α_2 in forming a groove bounded by two α -helices and a β -pleated sheet floor (Figure 4.19a and Figure 4.20).

The organization of the genes encoding the α chain of the human class II molecule HLA-DR and the main regulatory sequences that control their transcription are shown in Figure 4.21.

MHC class I and class II molecules are polygenic

Several different flavors of MHC class I and class II proteins are expressed by most cells. There are three different class I α -chain genes, referred to as *HLA-A*, *HLA-B*, and *HLA-C* in humans and *H-2K*, *H-2D*, and *H-2L* in the mouse, which can result in the expression of at least three different class I proteins in every cell. This number is doubled if an individual is **heterozygous** for the class I alleles expressed at each locus; indeed, this is often the case because of the **polymorphic** nature of class I genes, as we shall discuss later in this chapter.

There are also three different types of MHC class II α - and β -chain genes expressed in humans, *HLA-DQ*, *HLA-DP*, and *HLA-DR*, and two pairs in mice, *H2-A* (I-A) and *H2-E* (I-E). Thus, humans can express a minimum of three different class II molecules, with this number increasing significantly when polymorphisms are considered; this is because different α - and β -chain combinations can be generated when an individual is heterozygous for a particular class II gene.

The different types of class I and class II molecules all exhibit the same basic structure as depicted in Figure 4.19a and all participate in presenting peptides to T-cells but, because of significant differences in their peptide-binding grooves, **each presents a different range of peptides** to the immune system. This has the highly desirable effect of reducing the probability that peptides derived from pathogen proteins will fail to be presented.

Class I and class II MHC molecules probably evolved from a single ancestral gene that underwent serial gene duplications, followed by diversification owing to selective pressure, to generate the different class I and class II genes that we see today (Figure 4.22). Genes that failed to confer any selective advantage or that suffered deleterious mutations were either deleted from the genome or are still present as pseudogenes (genes that fail to express a functional protein); indeed many pseudogenes are present within the MHC region. This type of gene evolution pattern has been termed the **birth and death model** or the accordion model because of the way in which this gene region expanded and contracted during evolution.

Several immune response-related genes contribute to the remaining class III region of the MHC

A variety of other genes that congregate within the MHC chromosome region are grouped under the heading of class III. Broadly, one could say that many are directly or indirectly related to immune defense functions. A notable cluster involves four genes coding for complement components, two of which

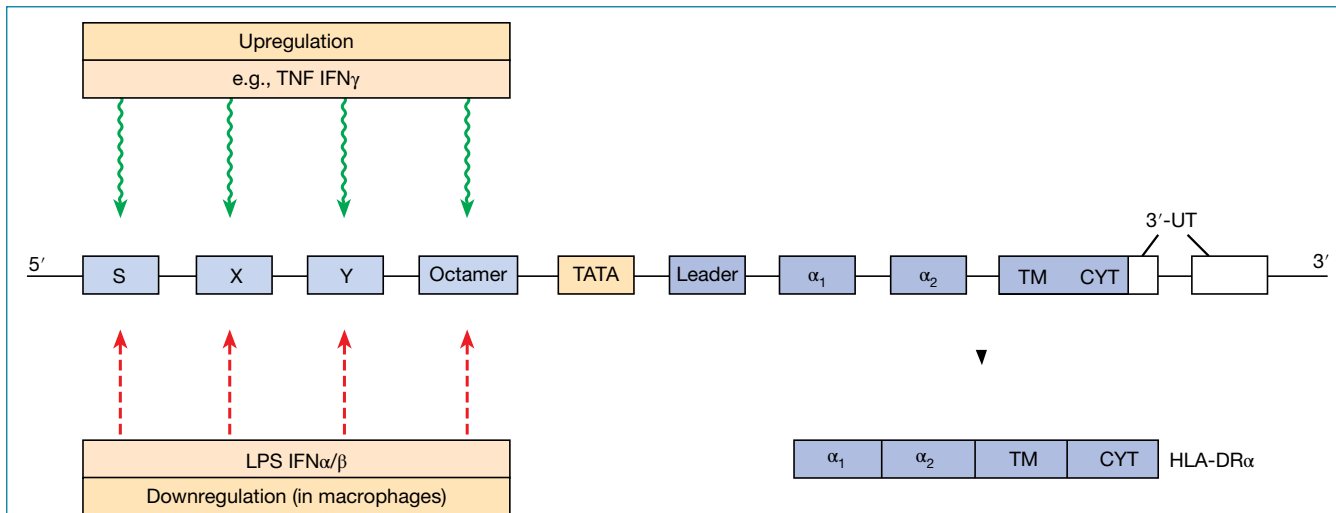


Figure 4.21 Genes encoding human HLA-DR α chain (darker blue) and their controlling elements (regulatory sequences in light blue and TATA box promoter in yellow). α_1/α_2 encode the two extracellular domains; TM and CYT encode the transmembrane and cytoplasmic segments, respectively. 3'-UT represents the 3'-untranslated sequence. Octamer motifs are also found in virtually all heavy and light chain immunoglobulin V gene promoters and in the promoters of other B-cell-specific genes such as *B29* and *CD20*.

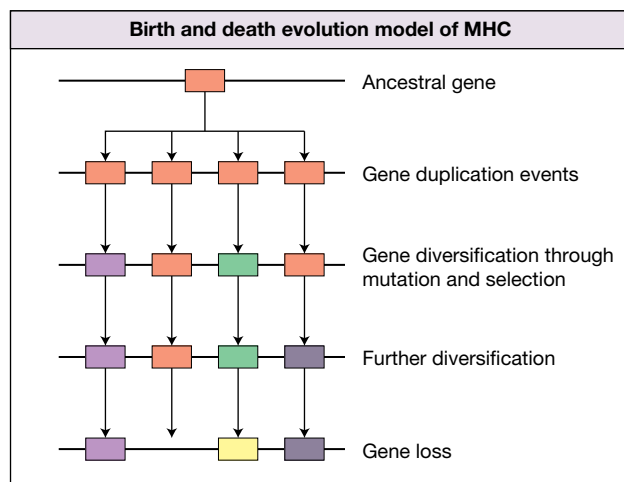


Figure 4.22 Birth and death model of MHC evolution. Different major histocompatibility complex (MHC) genes most likely arose through duplication events that resulted in diversification of the duplicated genes as a result of selective pressure. Genes that confer no selective advantage can suffer deleterious mutations resulting in pseudogenes or may be deleted from the genome altogether. Different environments impose distinct selective pressures, due to different pathogens for example, resulting in a high degree of polymorphism within this gene family. MHC polymorphism is seen primarily within the peptide-binding regions of MHC class I and class II molecules.

are for the *C4* isotypes *C4A* and *C4B* and the other two for *C2* and factor B. The cytokines tumor necrosis factor (TNF; sometimes referred to as $\text{TNF}\alpha$) and lymphotoxin ($\text{LT}\alpha$ and $\text{LT}\beta$) are encoded under the class III umbrella, as are three members of the human 70 kDa heat-shock proteins. As ever, things do

not quite fit into the nice little boxes we would like to put them in. Even if it were crystal clear where one region of the MHC ends and another begins (and it isn't), some genes located in the middle of the "classical" (see Figure 4.24) class I or II regions should more correctly be classified as part of the class III cohort. For example, the *LMP* and *TAP* genes concerned with the intracellular processing and transport of T-cell epitope peptides are found in the class II region but do not have the classical class II structure, nor are they expressed on the cell surface.

Gene map of the MHC

The complete sequence of a human MHC was published at the very end of the last millennium after a gargantuan collaborative effort involving groups in England, France, Japan, and the United States. The entire sequence, which represents a composite of several MHC haplotypes, comprises 224 gene loci. Of the 128 of these genes that are predicted to be expressed, it is estimated that about 40% of them have functions related to the immune system. It is not clear why so many immune response-related genes are clustered within this relatively small region, although this phenomenon has also been observed with housekeeping genes that share related functions. Because the location of a gene within chromatin can profoundly influence its transcriptional activity, perhaps it has something to do with ensuring that the genes within this region are expressed at similar levels. Genes found within condensed regions of chromatin are often expressed at relatively low levels and in some cases may not be expressed at all. The region between class II and class I in the human contains 60 or so class III genes. An overall view of the main clusters of class I, II, and III genes in the MHC of the mouse and human

Human	HLA gene	MICB	MICA	B	C	E	A	G	F
	Gene product	MICB	MICA	HLA-B	HLA-C	HLA-E	HLA-A	HLA-G	HA-FL
Mouse	H-2 gene	TAPASIN	K	D	L	Q	T	M	
	Gene product	TAPASIN	H-2K	H-2D	H-2L	Q	T	H-2M	

Figure 4.23 MHC class I gene map. The “classical” polymorphic class I genes, *HLA-A*, *-B*, *-C* in humans and *H-2K*, *-D*, *-L* in mice, are highlighted with orange shading and encode peptide chains that, together with β_2 -microglobulin, form the complete class I molecules originally identified in earlier studies as antigens by the antibodies they evoked on grafting into another member of the same species. Note that only some strains of mice possess an *H-2L* gene. The genes expressed most abundantly are *HLA-A* and *-B* in the human and *H-2K* and *-D* in the mouse. The other class I genes (“class Ib”) are termed “nonclassical” or “class I chain-related.” They are oligo- rather than polymorphic or sometimes invariant, and many are silent or pseudogenes. In the mouse there are approximately 15 *Q* (also referred to as *Qa*) genes, 25 *T* (also referred to as *TL* or *Tla*) genes and 10 *M* genes. *MICA* and *MICB* are ligands for NK cell receptors. Tapasin is involved in peptide transport. The gene encoding this molecule is at the centromeric end of the MHC region and therefore is shown in this gene map with respect to the mouse, but in Figure 4.24, the class II gene map is shown with respect to the human. Look at Figure M4.2.1 to see why.

Human	HLA gene	TAPASIN	DPB	DPA	DOA	DMA	DMB	LMP2	TAP1	LMP7	TAP2	DOB	DQB	DQA	DRB	DRA
	Gene product	TAPASIN	DP β	DP α	DO α	DM α	DM β	Proteasome complex		Peptide transporter		DO β	DQ β	DQ α	DR β	DR α
			HLA-DP		HLA-DO	HLA-DM						HLA-DO	HLA-DQ		HLA-DR	
Mouse	H-2 gene	Oa	Ma	Mb2	Mb1	LMP2	TAP2	LMP7	TAP1	Ob	Ab	Aa	Eb	Ea		
	Gene product	O α	DM α	DM β 2	DM β 1	Proteasome complex		Peptide transporter		β	A β	A α	E β	E α		
		H-2O	H-2DM							H-2O	H-2A		H-2E			

Figure 4.24 MHC class II gene map. With “classical” *HLA-DP*, *-DQ*, *-DR* in the human and *H-2A* (*I-A*) and *H-2E* (*I-E*) in mice more heavily shaded. Both α and β chains of the class II heterodimer are transcribed from closely located genes. There are usually two expressed *DRB* genes, *DRB1* and one of either *DRB3*, *DRB4*, or *DRB5*. A similar situation of a single α chain pairing with different β chains is found in the mouse *I-E* molecule. The *LMP2* and *LMP7* genes encode part of the proteasome complex that cleaves cytosolic proteins into small peptides that are transported by the *TAP* gene products into the endoplasmic reticulum. *HLA-DMA* and *-DMB* (mouse *H-2DMA*, *-DMb1* and *-DMb2*) encode the DM $\alpha\beta$ heterodimer that removes class II-associated invariant chain peptide (CLIP) from classical class II molecules to permit the binding of high affinity peptides. The mouse H-2DM molecules are often referred to as H-2M1 and H-2M2, although this is a horribly confusing designation because the term *H-2M* is also used for a completely different set of genes that lie distal to the *H-2T* region and encode members of the class Ib family (see Figure 4.23). The *HLA-DOA* (alternatively called *HLA-DNA*) and *-DOB* genes (*H-20a* and *-Ob* in the mouse) also encode an $\alpha\beta$ heterodimer that may play a role in peptide selection or exchange with classical class II molecules. (Source: Horton R. *et al.* (2004) *Nature Reviews Genetics* 5, 889–899. Reproduced with permission of Nature Publishing Group.)

may be gained from Figure M4.2.1 in Milestone 4.2. More detailed maps of each region are provided in Figure 4.23, Figure 4.24, and Figure 4.25. A number of pseudogenes have been omitted from these gene maps in the interest of simplicity.

The cell surface class I molecule, based on a transmembrane chain with three extracellular domains associated with β_2 -microglobulin, has clearly proved to be a highly useful structure judging by the number of variants on this theme that have arisen during evolution. It is helpful to subdivide them, first into the **classical class I molecules** (sometimes referred to as class Ia), *HLA-A*, *-B*, and *-C* in the human and *H-2K*, *-D*, and *-L* in the mouse. These were defined serologically by the antibodies arising in grafted individuals using methods developed from Gorer’s pioneering studies (Milestone 4.2).

Other molecules, sometimes referred to as class Ib, have related structures and are either encoded within the MHC locus itself (“**nonclassical**” MHC molecules, for example the human *HLA-E*, *-F*, and *-G*, *HFE*, *MICA* and *MICB*, the murine *H-2T*, *-Q*, and *-M*), or elsewhere in the genome (“**class I chain-related**,” including the *CD1* family and *FcRn*). Nonclassical MHC genes are far less polymorphic than the classical MHC, are often invariant, and many are pseudogenes. Many of these nonclassical MHC class I molecules form structures that are very similar to class I molecules and have also been found to either present nonpeptide antigens or canonical (i.e., invariant) peptides that serve roles in monitoring overall cell stress levels. We will discuss these nonclassical MHC molecules in more detail towards the end of this chapter.

Human	<i>CYP21B</i>	<i>C4B</i>	<i>CYP21A</i>	<i>C4A</i>	<i>BF</i>	<i>C2</i>	<i>HSPA1B</i>	<i>HSPA1A</i>	<i>HSPA1L</i>	<i>LTB</i>	<i>TNF</i>	<i>LTA</i>
Mouse	<i>CYP21A1</i>	<i>C4</i>	<i>CYP21A2</i>	<i>Slp</i>	<i>BF</i>	<i>C2</i>	<i>HSP70-1</i>	<i>HSP70-3</i>	<i>Hsc70t</i>	<i>LTB</i>	<i>TNF</i>	<i>LTA</i>

Figure 4.25 MHC class III gene map. This region is something of a “rag bag.” Aside from immunologically “respectable” products such as C2, C4, factor B (encoded by the *BF* gene), tumor necrosis factor (*TNF*), lymphotoxin- α and lymphotoxin- β (encoded by *LTA* and *LTB*, respectively) and three 70 kDa heat-shock proteins (the *HSPA1A*, *HSPA1B*, and *HSPA1L* genes in humans, *HSP70-1*, *HSP70-3*, and *Hsc70t* genes in mice), genes not shown in this figure but nonetheless present in this locus include those encoding valyl tRNA synthetase (*G7a*), NOTCH4, which has a number of regulatory activities, and tenascin, an extracellular matrix protein. Of course many genes may have drifted to this location during the long passage of evolutionary time without necessarily having to act in concert with their neighbors to subservise some integrated defensive function. The 21-hydroxylases (21OHA and B, encoded by *CYP21A* and *CYP21B*, respectively) are concerned with the hydroxylation of steroids such as cortisone. *Slp* (sex-limited protein) encodes a murine allele of C4, expressed under the influence of testosterone.

The genes of the MHC display remarkable polymorphism

Unlike the immunoglobulin system where, as we have seen, variability is achieved in each individual by a **multigenic** system, the MHC has evolved in terms of variability between individuals with a highly **polymorphic** (literally “many shaped”) system based on **multiple alleles** (i.e., alternative genes at each locus). This has likely arisen through **pathogen-driven selection** to form new alleles that may offer increased “fitness” for the individual; in this context, fitness could mean increased protection from an infectious organism. The class I and class II genes are the most polymorphic genes in the human genome; for some of these genes over 600 allelic variants have been identified (Figure 4.26). This implies that there has been intense selective pressure on the MHC gene region and that genes within this region are mutating at rates much faster than those at other gene loci.

As is amply illustrated in Figure 4.26, class I HLA-A, -B, and -C molecules are highly polymorphic and so are the class II β chains (HLA-DR β most, -DP β next, and -DQ β third) and, albeit to a lesser extent than the β chains, the α chains of -DP and -DQ. HLA-DR α and β_2 -microglobulin are invariant in structure. The amino acid changes responsible for this polymorphism are restricted to the α_1 and α_2 domains of class I and to the α_1 and β_1 domains of class II. It is of enormous significance that they occur essentially in the β -sheet floor and on the inner surfaces of the α -helices that line the central cavity (Figure 4.19a) and also on the upper surfaces of the helices; these are the very surfaces that make contact with the peptides that these MHC molecules offer up for inspection by TCRs (Figure 4.20). The nonrandom location at which MHC alleles diverge from one another is as a result of positive selection over the course of animal evolution due to host–pathogen interactions. As a consequence of the polymorphic nature of MHC molecules, the spectrum of peptides bound by these molecules is highly variable. In Chapter 5 we will explore in greater detail how peptide interacts with the β -pleated sheet floor of MHC molecules, as these interactions dramatically influence the type of peptides that can be presented by particular molecules. The ongoing drive towards creating new MHC molecules,

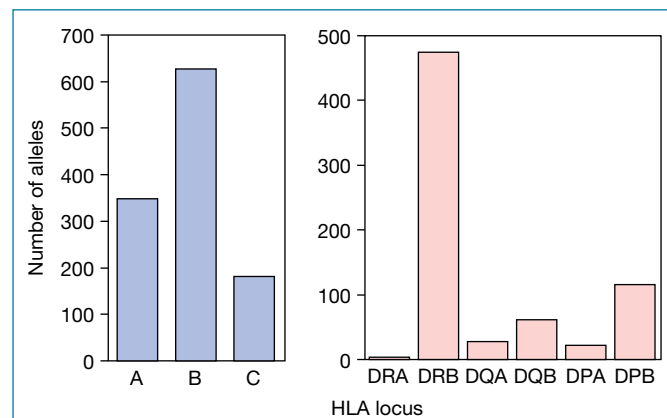


Figure 4.26 Polymorphism within human HLA (human leukocyte antigen) class I and class II genes. Number of distinct human HLA class I (A, B, C) and class II (DRA, DRB, DQA, DQB, DPA, DPB) alleles at each locus as of January 2005. (Adapted from Marsh S.G. et al. (2005) *Tissue Antigens* 65, 301. Reproduced with permission of Wiley.)

with slightly altered peptide-binding grooves, is akin to a genetic arms race where the immune system is constantly trying to keep one step ahead of its foe. This genetic one-upmanship has been termed **pathogen-driven balancing selection** because heterozygotes typically have a selective advantage over homozygotes at a given locus.

The MHC region represents an outstanding hotspot with mutation rates two orders of magnitude higher than non-MHC loci. These multiple allelic forms can be generated by a variety of mechanisms: point mutations, recombination, homologous but unequal crossing over, and **gene conversion**.

The degree of sequence homology and an increased occurrence of the dinucleotide motif 5′-cytosine–guanine-3′ (to produce what are referred to as CpG islands) seem to be important for gene conversion, and it has been suggested that this might involve a DNA-nicking activity that targets CpG-rich DNA sequences. MHC genes that lack these sequences, for example *H-2Ea^d* and *HLA-DRA*, do not appear to undergo gene conversion, whereas those that possess CpG islands act as either donors (e.g., *H-2Eb^b*, *H-2Q2^b*, *H-2Q10^b*), acceptors

(e.g., $H-2A^b$) or both (e.g., $H-2K^k$, $HLA-DQB1$). The large number of pseudogenes within the MHC may represent a stockpile of genetic information for the generation of polymorphic diversity in the “working” class I and class II molecules.

Nomenclature

As much of the experimental work relating to the MHC is based on experiments in our little laboratory friend, the mouse, it may be helpful to explain the nomenclature used to describe the allelic genes and their products. If someone says to you in an obscure language “we are having free elections,” you fail to understand, not because the idea is complicated but because you do not comprehend the language. It is much the same with the shorthand used to describe the H-2 system, which looks unnecessarily frightening to the uninitiated. In order to identify and compare allelic genes within the H-2 complex in different strains, it is usual to start with certain pure homozygous

inbred strains, obtained by successive brother–sister matings, to provide the prototypes. The collection of genes in the H-2 complex is called the **haplotype** and the haplotype of each prototypic inbred strain will be allotted a given superscript. For example, the DBA strain haplotype is designated $H-2^d$ and the genes constituting the complex are therefore $H-2K^d$, $H-2Aa^d$, $H-2Ab^d$, $H-2D^d$, and so on; their products will be $H-2K^d$, $H-2A^d$, and $H-2D^d$, and so forth (Figure 4.27). When new strains are derived from these by genetic recombination during breeding, they are assigned new haplotypes, but the individual genes are designated by the haplotype of the prototype strain from which they were derived. Thus the A/J strain produced by genetic cross-over during interbreeding between ($H-2^k \times H-2^d$) F1 mice (Figure 4.28) is arbitrarily assigned the haplotype $H-2^e$, but Table 4.4 shows that individual genes in the complex are identified by the haplotype symbol of the original parents.

Strain	Haplotype	MHC designation	I	II				III		I	
C57BL	b	$H-2^b$	K^b	Ab^b	Aa^b	Eb^b	Ea^b	$C4^b$	etc	D^b	etc.
CBA	k	$H-2^k$	K^k	Ab^k	Aa^k	Eb^k	Ea^k	$C4^k$	etc	D^k	etc.

Figure 4.27 How the definition of $H-2$ haplotype works. Pure strain mice homozygous for the whole $H-2$ region through prolonged brother–sister mating for at least 20 generations are each arbitrarily assigned a haplotype designated by a superscript. Thus the particular set of alleles that happens to occur in the strain named C57BL is assigned the haplotype $H-2^b$ and the particular nucleotide sequence of each allele in its MHC is labeled as gene^b (e.g., $H-2K^b$). It is obviously more convenient to describe a given allele by the haplotype than to trot out its whole nucleotide sequence, and it is easier to follow the reactions of cells of known $H-2$ make-up by using the haplotype terminology (see, for example, the interpretation of the experiment in Figure 4.28).




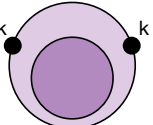
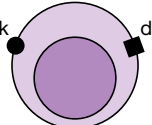
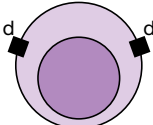
Strain	CBA	F ₁ hybrid	DBA/2
H-2 Genotype		$k \times d$ ▼ 	
Lymphocytes (H-2 phenotype)			
Anti- $H-2^k$	killing	killing	—
Anti- $H-2^d$	—	killing	killing

Figure 4.28 Inheritance and co-dominant expression of MHC genes. Each homozygous (pure) parental strain animal has two identical chromosomes bearing the $H-2$ haplotype, one paternal and the other maternal. Thus in the present example we designate a strain that is $H-2^k$ as k/k . The first familial generation (F₁) obtained by crossing the pure parental strains CBA ($H-2^k$) and DBA/2 ($H-2^d$) has the $H-2$ genotype k/d . As 100% of F₁ lymphocytes are killed in the presence of complement by antibodies to $H-2^k$ or to $H-2^d$ (raised by injecting $H-2^k$ lymphocytes into an $H-2^d$ animal and vice versa), the MHC molecules encoded by both parental genes must be expressed on every lymphocyte. The same holds true for other tissues in the body.

Inheritance of the MHC

Pure strain mice derived by prolonged brother–sister mating are homozygous for each pair of homologous chromosomes. Thus, in the present context, the haplotype of the MHC derived from the mother will be identical to that from the father; animals of the C57BL strain, for example, will each bear two chromosomes with the $H-2^b$ haplotype (see Table 4.4).

Let us see how the MHC behaves when we cross two pure strains of haplotypes $H-2^k$ and $H-2^d$, respectively. We find that the lymphocytes of the offspring (the F1 generation) all display both $H-2^k$ and $H-2^d$ molecules on their surface (i.e., there is **co-dominant expression**) (Figure 4.28). If we go further and breed F1s together, the progeny have the genotypes k , k/d , and d in the proportions to be expected if the **haplotype segregates as a single mendelian trait**. This happens because the $H-2$ complex spans 0.5 centimorgans, equivalent to a recombination frequency between the K and D ends of 0.5%, and the haplotype tends to be inherited *en bloc*. Only the relatively infrequent recombinations caused by meiotic cross-over events, as described for the A/J strain above, reveal the complexity of the system.

The tissue distribution of MHC molecules

Essentially, all nucleated cells carry classical class I molecules. These are abundantly expressed on both lymphoid and myeloid cells, less so on liver, lung, and kidney and only sparsely on brain and skeletal muscle. In the human, the surface of the placental extravillous cytotrophoblast lacks HLA-A and -B, although there is now some evidence that it may express HLA-C. What is well established is that the extravillous cytotrophoblast and other placental tissues bear HLA-G, a molecule that generally lacks allodeterminants and that does not appear on most other body cells, except for medullary and subcapsular epithelium in the thymus, and on blood monocytes following activation with interferon- γ . The role of HLA-G in the placenta is not fully resolved, but it appears to function as a replacement for classical class I molecules serving to inhibit

immune responses against paternal MHC alleles carried by the fetus. Class II molecules, on the other hand, are highly restricted in their expression, being present only on B-cells, dendritic cells, macrophages, and thymic epithelium. However, when activated by agents such as interferon- γ , capillary endothelia and many epithelial cells in tissues other than the thymus express surface class II and increased levels of class I.

The nonclassical MHC and class I chain-related molecules

These molecules include the **CD1** family that utilize β_2 -microglobulin and have an overall structure similar to the classical class I molecules (Figure 4.29). They are, however, encoded by a set of genes on a different chromosome to the MHC, namely on chromosome 1 in humans and chromosome 3 in the mouse. Like its true MHC counterparts, CD1 is involved in the presentation of antigens to T-cells, but the antigen-binding groove is to some extent covered over, contains mainly hydrophobic amino acids, and is accessible only through a narrow entrance. Instead of binding peptide antigens, the CD1 molecules generally present lipids or glycolipids. At least four different CD1 molecules are found expressed on human cells; CD1a, b, and c are present on cortical thymocytes, dendritic cells and a subset of B-cells, whereas CD1d is expressed on intestinal epithelium, hepatocytes, and all lymphoid and myeloid cells. Mice appear to only express two different CD1 molecules that are both similar to the human CD1d in structure and tissue distribution and are referred to as CD1d1 and CD1d2 (or CD1.1 and CD1.2).

Genes in the MHC itself that encode nonclassical MHC molecules include the $H-2T$, $H-2Q$, and $H-2M$ loci in mice, each of which encodes a number of different molecules. The T22 and T10 molecules, for example, are induced by cellular activation and are recognized directly by $\gamma\delta$ TCR without a requirement for antigen, possibly suggesting that they are involved in triggering immunoregulatory $\gamma\delta$ T-cells. Other nonclassical class I molecules do bind peptides, such as $H-2M3$ that presents N -formylated peptides produced either in mitochondria or by bacteria.

In the human, **HLA-E** binds a nine-amino-acid peptide derived from the signal sequence of HLA-A, -B, -C, and -G molecules, and is recognized by the CD94/NKG2 receptors on NK cells and cytotoxic T-cells, as well as by the $\alpha\beta$ TCR on some cytotoxic T-cells. **HLA-E** is upregulated when other HLA alleles provide the appropriate leader peptides, thereby allowing NK cells to monitor the expression of polymorphic class I molecules using a single receptor. The murine homolog, Qa-1, has a similar function.

The stress-inducible MICA and MICB (MHC class I chain-related molecules) have the same domain structure as classical class I and display a relatively high level of polymorphism. They are present on epithelial cells, mainly in the gastrointestinal tract and in the thymic cortex, and are recognized by the NKG2D-activating molecule. One possible role

Table 4.4 The haplotypes of the $H-2$ complex of some commonly used mouse strains and recombinants derived from them. A/J was derived by interbreeding ($k \times d$) F1 mice, recombination occurring between E (class II) and S (class III) regions*.

Strain	Haplotype	Origin of individual regions				
		K	A	E	S	D
C57BL	b	b	b	b	b	b
CBA	k	k	k	k	k	k
DBA/2	d	d	d	d	d	d
A/J	a	k	k	k^*	d	d
B.10A(4R)	$h4$	k	k	b	b	b

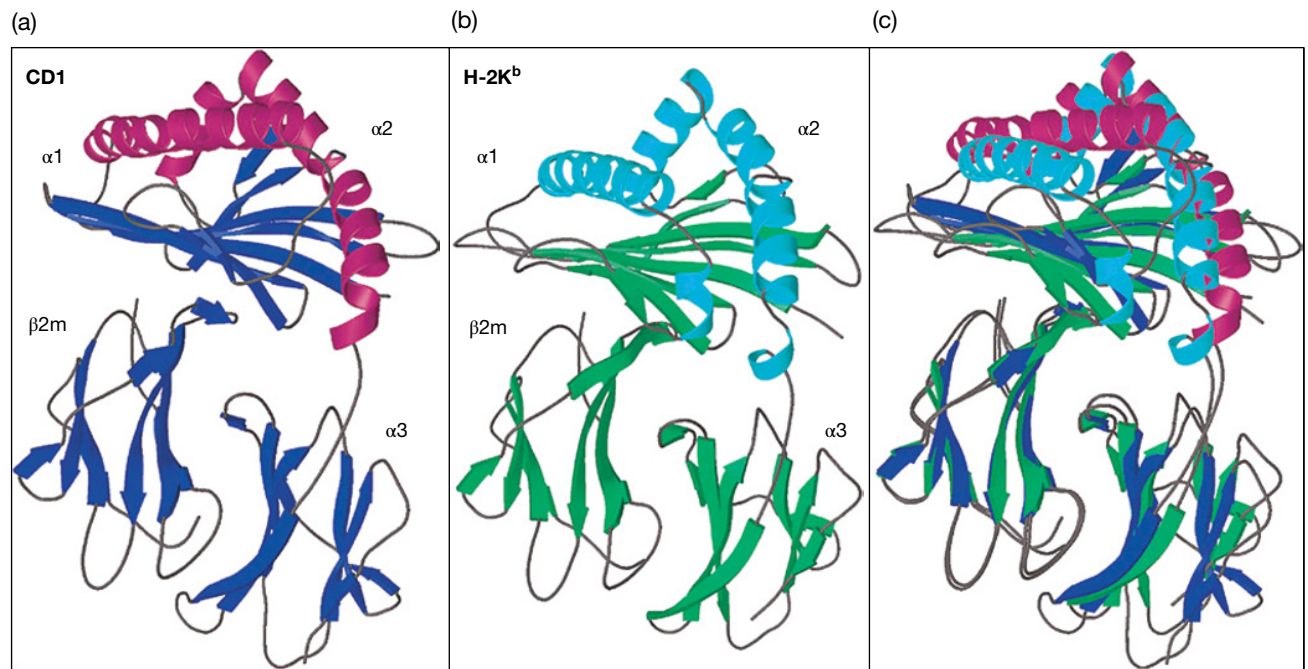


Figure 4.29 Comparison of the crystal structures of CD1 and MHC class I. (a) Backbone ribbon diagram of mouse CD1d1 (red, α -helices; blue, β -strands). (b) Ribbon diagram of the mouse MHC class I molecule H-2K^b (cyan, α -helices; green, β -strands). (c) Superposition using alignment of β_2 -microglobulin highlights some of the differences between CD1d1 and H-2K^b. Note in particular the shifting of the α -helices. This produces a deeper and more voluminous groove in CD1d1, which is narrower at its entrance compared with H-2K^b. (Source: Porcelli S.A. *et al.* (1998) *Immunology Today* **19**, 362. Reproduced with permission of Elsevier.)

for this interaction is in the promotion of NK cell and T-cell antitumor responses.

The function of *HLA-F* is unclear, although its expression in placental trophoblasts has led some to suggest that it may play a role in protecting the developing fetus from attack by the maternal immune system. A more definitive role for *HLA-G* in this context has been found. This HLA molecule is also preferentially expressed on placental trophoblast cells where it plays a role in shielding the fetus from the unwanted attentions of the maternal NK cells and cytotoxic T-cells. It has long been a puzzle why mothers tolerate their genetically non-identical fetuses, as one would normally expect a strong immune response to foreign (i.e., paternal) HLA molecules. Although this is partially solved through downregulation of the expression of MHC class I A, B, and C molecules on placenta, this would normally attract the attentions of NK cells on the prowl for cells with such missing-self characteristics, as we discussed earlier when dealing with NK receptors. HLA-G expression on the placental–maternal trophoblast interface appears to be a solution to this. The interaction between the immunoglobulin-like transcript-2 (ILT2) molecule on NK cells, which is an inhibitory NK receptor, with HLA-G expressed on placental trophoblasts confers protection against NK cell-mediated cytotoxicity.

HFE, previously referred to as HLA-H, possesses an extremely narrow groove that is unable to bind peptides, and it may serve no role in immune defense. However, it binds to the

transferrin receptor and appears to be involved in iron uptake. A point mutation (C282Y) in *HFE* is found in 70–90% of patients with hereditary hemochromatosis.

Nonclassical MHC molecules may be the precursors to classical MHC molecules

Analysis of vertebrate genomes suggests that invariant nonclassical MHC molecules are probably the primordial forerunner to modern polymorphic MHC class I and class II molecules and rather than playing a role in antigen presentation, these molecules were most likely used as primitive “danger signals” involved in conveying stress signals to innate immune cells. Thus, expression of these molecules on the cell surface signified a stressed or potentially transformed cell that should be eliminated in the interests of overall organismal fitness. During the course of evolution, such molecules then most likely evolved the ability to bind self peptides, which were initially relatively invariant, followed by the ability to bind highly variable peptides, as we now see with classical MHC class I and class II gene products. The appearance of polymorphic MHC molecules, as a consequence of gene duplication events followed by divergence, would have enabled much greater diversity in the range of peptides bound by these molecules. Thus, invariant MHC-like molecules (such as HLA-E, -F, -G, and MICA, MICB) tend not to have antigen-presenting functions, but perform

homeostatic or regulatory roles, permitting cells of the innate immune system to monitor cell health in a relatively antigen-nonspecific way.

A good example, which was discussed in the context of NK receptors but is worth going over again, is the HLA-E molecule that binds a nine-amino-acid peptide derived from the signal sequence of HLA-A, -B, and -C molecules. Should HLA-E-peptide complexes be absent from cells, this suggests that an infectious agent may be present or that cells are stressed in some way. This results in activation of NK cells via the activating CD94/NKG2 receptors, with consequent NK-mediated killing of such cells. In the absence of class I leader peptides, HLA-E can be stabilized on the surface of stressed cells by heat-shock treatment because the HSP-60 signal peptide can also bind in place of HLA class I peptides. However, such HLA-E/HSP-60 leader peptide complexes fail to be recognized by the CD94/NKG2 receptor, once again precipitating attack by the NK cell. Thus, cell stress can override the presentation of class I-derived peptides through competition for HSP-60-derived peptides that would not normally be present at levels high enough to compete effectively in unstressed cells. If this isn't a clever molecular security system, we don't know what is.

Pathogen recognition receptors provide the first line of detection for microbial antigen

As we learned in Chapter 1, the innate immune system employs an impressive battery of defense mechanisms that specifically detect the presence of invading microbes, to coordinate a series of rapid responses that deal directly with the invader, while at the same time sowing the seeds for a more specific and long-lasting adaptive immune response. Over many millennia of co-evolution, vertebrate immune systems have become impressively adept at accurately identifying the presence of potentially harmful microbes, through the detection of microbial structures that are essential for viability and, therefore, refractive to the pressures of natural selection. These conserved microbial antigens, called *pathogen-associated molecular patterns (PAMPs)*, are unique to individual classes of microbes, and as such, convey pathogen-specific information to the innate immune system, to facilitate an appropriate response tailored to the particular threat at hand.

Detection of PAMPs is facilitated by a family of evolutionarily conserved germline-encoded receptors called *pathogen recognition receptors (PRRs)*, expressed on innate immune cells such as DCs, macrophages, and neutrophils. PAMP detection is often the first indication to the innate immune system of microbial presence and consequently, PAMP-induced PRR activation rapidly promotes the production of a host of cytokines, chemokines, and type 1 interferons that mobilize innate immune cells to directly confront the invader. Additionally, PRR stimulation acts as a crucial line of communication between the innate and adaptive immune systems by instructing antigen-presenting cells, such as DCs, to effectively

license a T-cell-mediated adaptive immune response against a particular antigen. As will be discussed in later chapters, the particular mode of T-cell activation is further shaped by PRR-induced DC-derived cytokines, which effectively tailor the T-cell-mediated response to the particular type of microbe. As PRR signaling has also been shown to be important for instructing B-cells to respond to particular types of microbial antigen, it should be clear that the recognition of microbial PAMP by PRRs plays a crucial role in coordinating both innate and adaptive immune responses to infection.

To date, several different classes of PRRs have been characterized, including Toll-like receptors (TLRs), NOD-like receptors (NLRs), RIG-1-like receptors (RLRs), DNA receptors, and C-type lectin-like receptors, which together sense a wide range of conserved microbial antigen. TLRs are among the best-characterized PRRs and we will next turn our attention to this important immune receptor family.

Toll-like receptors detect a wide range of conserved microbial PAMP

Named after a *Drosophila* protein that was originally discovered as important for embryogenesis and later, as required for anti-fungal immunity, *Toll-like receptors (TLRs)* are a key family of mammalian PRRs involved in the detection of a wide variety of PAMPs. To date, 10 TLRs have been described in humans, and 12 have been characterized in mice. TLR1, 2, 4, 5, and 6 are expressed on the *cell surface* and detect ligands from bacteria, fungi, protozoa, and certain self antigens, whereas expression of TLR3, 7, 8, and 9 are confined to *intracellular endocytotic compartments*, where they recognize nucleic acid signatures unique to bacteria and viruses (Figure 4.30a).

TLRs are type 1 integral membrane receptors composed of an extracellular ligand-binding domain, a single transmembrane helix, and an intracellular *Toll/IL-1R (TIR) signaling domain*, named because of its homology to the signaling domains of the interleukin-1 receptor superfamily. Ligand binding induces dimerization of extracellular TLR domains, which in turn facilitates the localization and subsequent dimerization of intracellular TIR domains required for signaling. Dimerized TIR domains then recruit various adaptors, including *myeloid differentiation primary response protein 88 (MyD88)* (Figure 4.30b) and *TIR-domain-containing adaptor inducing interferon- β (TRIF)*, which ultimately promote activation of transcription factors such as nuclear factor κ B (NF κ B) and interferon regulatory factors (IRFs), responsible for inducing expression of cytokines, chemokines, and antimicrobial factors.

TLRs belong to the *leucine-rich repeat (LRR)* family of proteins, with extracellular domains characterized by tandem repeats of LRR modules of 20–30 amino acids in length, with the hydrophobic leucines spaced at defined intervals. The leucines face toward the interior of the protein, forming a hydrophobic core that acts to stabilize overall protein structure, with variable regions facing outward to form a β -sheet. Such an

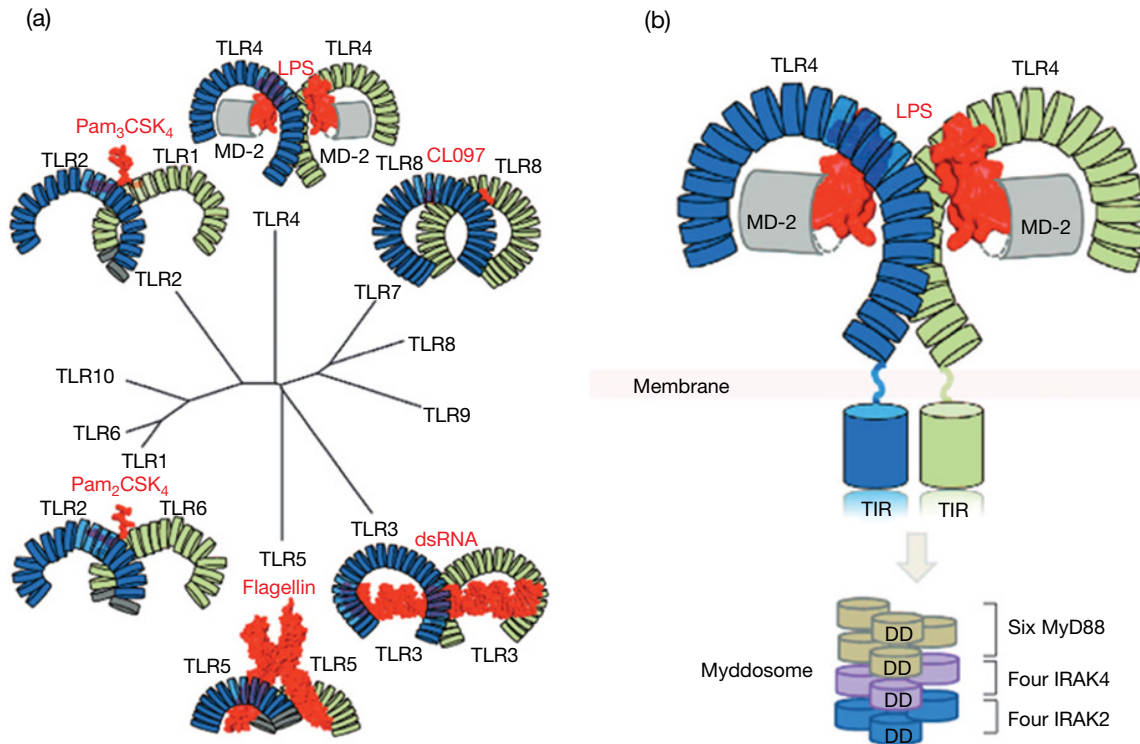


Figure 4.30 TLR family structure, ligand specificity, and signaling mechanism (a) Structures of TLRs bound to ligand and arranged into a phylogenetic tree. The ligands are colored red, and TLRs are blue and green. (b) Overview of LPS recognition by TLR4/MD-2. LPS binding induces dimerization of the TLR4/MD-2 complex, which is proposed to enable dimerization of the intracellular TIR domains and recruitment of adapter molecules such as MyD88. Aggregation of the death domains (DD) of MyD88 brings four IRAK4 and four IRAK2 molecules together forming a large tower-like structure called the “Myddosome.” (Source: Park B.S. *et al.* (2013) *Experimental and Molecular Medicine* 45(12), 1–9. Reproduced with permission of Nature Publishing Group.)

arrangement gives TLRs a classical *solenoid-like* shape, with each LRR module organized into adjacent, coiled, circular structures, similar to the way nuclear DNA is wound around histones, while the β -sheet of one LRR is arranged in parallel with the β -sheet of an adjacent LRR. As the β -sheets are more tightly packed than the rest of the LRR, the overall structure of the receptor is forced to bend into a *horseshoe shape*, with β -sheets arranged on the concave side (Figure 4.31a). Although the majority of LRR family proteins interact with protein ligands, TLRs are distinct in their interaction with nonprotein antigens, with ligands interacting at the concave or lateral sides of the receptor.

Although all TLRs share similar overall structure, they display considerable divergence in their ligand-binding affinities, driven mainly by differences in the size and charge of ligand-binding pockets, and their ability to engage in *ligand-induced homodimerization* (TLR3, TLR7) and *ligand-driven heterodimerization* with other members of the TLR family (TLR2/1, TLR2/6), and with non-TLR co-receptors (TLR4/MD-2) (Figure 4.30a). Regardless of the ligand specificity of individual TLRs, ligand-induced dimerization of adjacent receptors results in a characteristic “*m-shaped*” conformation,

with the TLRs interacting at their C-termini to drive dimerization of intracellular TIR domains. To look at the structure of TLRs more closely, we will next turn to possibly the best-characterized of these receptors, TLR4.

The TLR4/MD-2 complex detects microbial lipopolysaccharide

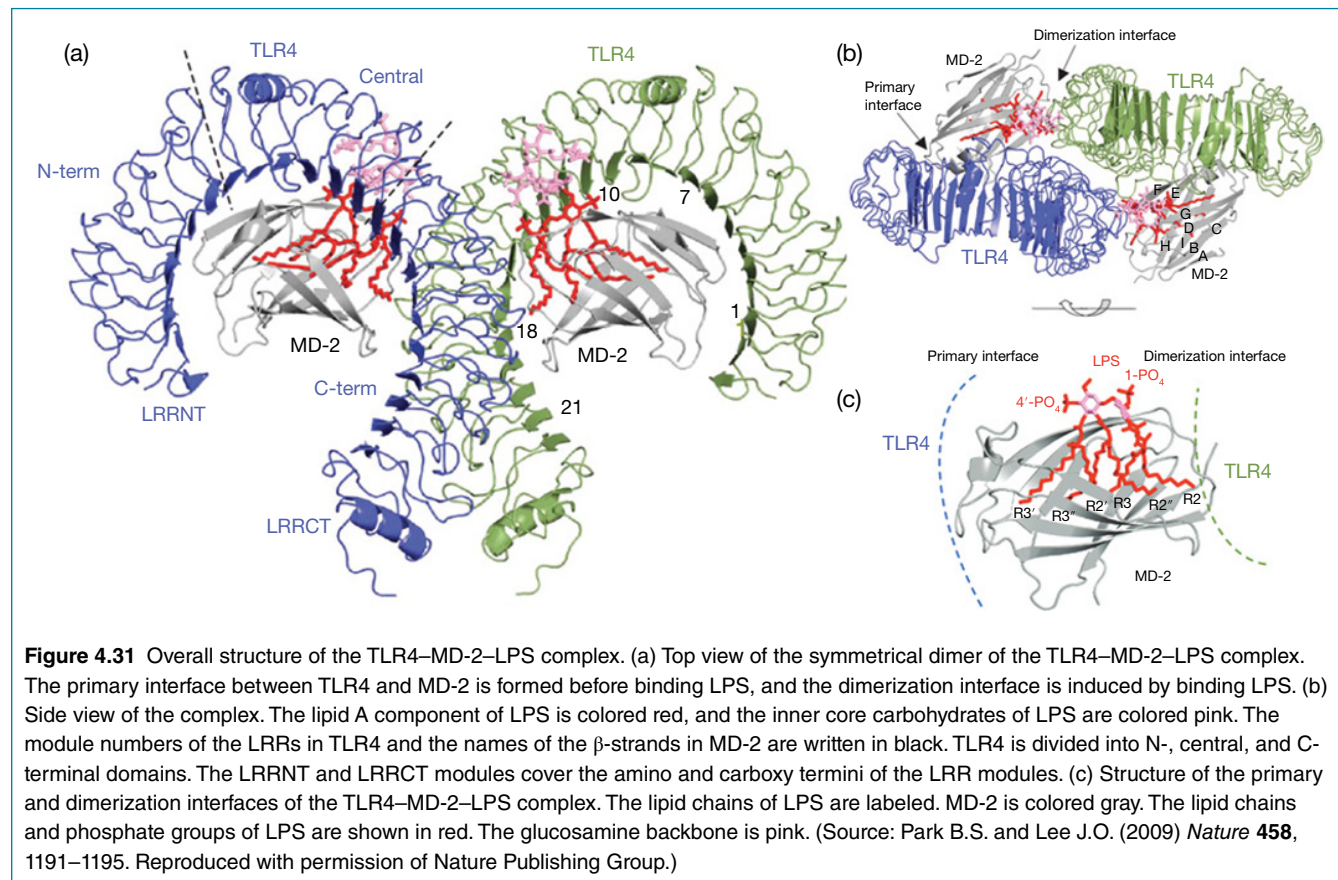
Lipopolysaccharide (LPS) is an essential component of Gram-negative bacterial cell walls, capable of inducing potent immune responses at extremely low concentrations, which, if left unchecked, can lead to septic shock and death. Such an acute response suggests that mammalian innate immune systems have evolved to detect this PAMP with exquisite sensitivity and this detection is carried out by TLR4, in conjunction with its *co-receptor* MD-2, both of which are abundantly expressed on the majority of innate immune cells, and on B-cells, and barrier tissues at the front line of infection. This double team forms a **1 : 1 heterodimer**, with TLR4-bound MD-2 acting as the primary binding interface with LPS. Interaction between LPS and MD-2 opens up MD-2 residues that promote stable interaction with adjacent TLR4 molecules, promoting dimerization of adjacent TLR4/MD-2 complexes, with the

subsequent dimerization of intracellular TIR domains that triggers signaling.

Native LPS is buried in bacterial cell walls in a difficult-to-detect conformation, but is efficiently extracted by a serum factor called **LPS-binding protein (LBP)** and facilitated by complement factors that punch holes in bacterial cell walls, dispersing bite-sized chunks of LPS-containing material into the bloodstream. LBP transfers LPS oligomers to **CD14**, which further splits them into monomers, for presentation to the TLR4/MD-2 complex for efficient detection. Prior to LPS binding, TLR4 and MD-2 are bound together as heterodimers, with the 21 LRR TLR4 ectodomain arranged in the typical horseshoe shape, and the smaller MD-2 molecules bound to the lateral side, suspended downwards in a hanging, flower basket-like arrangement (Figure 4.31a). MD-2 is the main interactor with LPS and adopts a cup-like structure, with two antiparallel β -sheets forming a stable barrel-shaped core that can accommodate lipid molecules of a defined size. LPS is a glycolipid with a hydrophobic **lipid A region** attached to a carbohydrate chain and the number of lipid chains in the lipid A segment appears to be a critical determinant of TLR4/MD-2 complex activation, with six lipid chains forming the ideal number. Indeed, the lipid A region is responsible for the majority of inflammatory activity of LPS, with five lipid chains exhibiting 100-fold lower activity and four lipid chains, such as eritoin, acting as inhibitors. The

crystal structure of the TLR4 ectodomain/MD-2/LPS complex illustrates the preference for six chains. Five lipid A chains of LPS are buried deeply in the **hydrophobic β -pocket of MD-2**, while the sixth lipid A residue is exposed, with negatively charged phosphate groups making critical contacts with positively charged residues on both MD-2 and the TLR4 ectodomain. Importantly, these interactions re-orientate MD-2 such that its **F126 and L87 loops** become exposed and are now free to make contact with a separate, adjacent, TLR4 molecule, also bound to its own MD-2, which, in turn, makes a reciprocal interaction. This site of interaction between adjacent LPS and MD-2 molecules is called the **dimerization interface** and promotes dimerization of adjacent TLR4/MD-2 molecules with the resulting heterotetrameric complex of TLR4–MD-2–LPS, in a 2 : 2 : 2 ratio (Figure 4.31a). The net result of all these interactions results in stable interaction between the C-termini of two TLR4 ectodomains, forming an m-shaped structure that facilitates close interaction and subsequent dimerization of intracellular TIR domains (Figure 4.31a,b).

As noted above, TIR domain dimerization is required for the recruitment of the TIR domain-containing adaptor MyD88, which recruits IRAK4 and IRAK2 in a defined structure that has been dubbed the **Myddosome**, which relays the inflammatory signal into the cell. We will look more closely at how the structure of the Myddosome is organized



to perform this task but first let us take a look at a TLR with binding properties that are different from those of the TLR4/MD-2 complex, TLR2.

TLR2/1/6

TLR2 plays a crucial role in the recognition of *microbial lipopeptides*, and mice deficient in this receptor are at increased risk of infection with a variety of bacteria, including *S. pneumoniae* and *M. tuberculosis*. Bacterial lipoproteins are composed of a glycerol backbone with either two or three attached acyl (fatty acid) chains. *Gram-negative bacteria* possess *triacylated lipoproteins* with two fatty acid chains, attached by ester bonds to an N-terminal cysteine, with the third lipid chain connected to the cysteine by an amide bond, whereas lipoproteins from *Gram-positive bacteria and mycoplasma* are *diacylated* as they lack the amide-bound lipid chain and thus have just two fatty acid chains. Early gene knockout studies showed that macrophages from TLR2-deficient mice lost the ability to respond to both di- and triacylated lipoproteins from a variety of bacteria. Interestingly, TLR1-deficient macrophages lost the ability to respond to triacylated lipoproteins only, whereas macrophages deficient in TLR6 failed to respond to the diacylated form. These results strongly suggest that TLR2 worked in conjunction with TLR1 to detect triacylated lipoproteins from Gram-positive bacteria, while it paired up with TLR6 for detection of Gram-positive bacteria bearing diacylated lipoproteins. Indeed, subsequent crystal structures confirmed this data, showing that triacylated lipoproteins simultaneously bound both TLR1 and TLR2, effectively acting as a bridge to draw the two receptors close enough together for dimerization to occur, while diacylated lipoproteins formed a complex with both TLR2 and TLR6.

Although TLR2 can directly bind both di- and triglycerides without the need for intervention from TLR1 or TLR6, this binding does not promote an optimal interaction between individual lipoprotein-bound TLR2 receptors and thus, the dimerization of adjacent TLR2 ectodomains required for intracellular signaling fails to occur. This is due to the fact that TLR2 efficiently binds the first two lipid chains on a lipoprotein, leaving the rest of the molecule free to undergo specific interactions with TLR1, in the case of the triacylated form, or TLR6 for diacylated lipoproteins. Indeed it is the specificity of TLR1 for triacylated lipoproteins and TLR6 for diacylated lipoproteins that confers specificity on the TLR2/1 and TLR2/6 complexes.

The ectodomains of all three TLRs display the characteristic TLR horseshoe shape, with 20 LRR modules each containing 24 residues, and can be divided into three distinct subdomains: N-terminal, central, and C-terminal (Figure 4.32a). Although the N-terminal domain shares homology with other LRRs, the central and C-terminal domains of TLR1 and TLR2 deviate from the norm, with the border between these two domains molded into *ligand-binding pockets, lined with hydrophobic residues*. The ligand-binding pocket on TLR2 is large enough

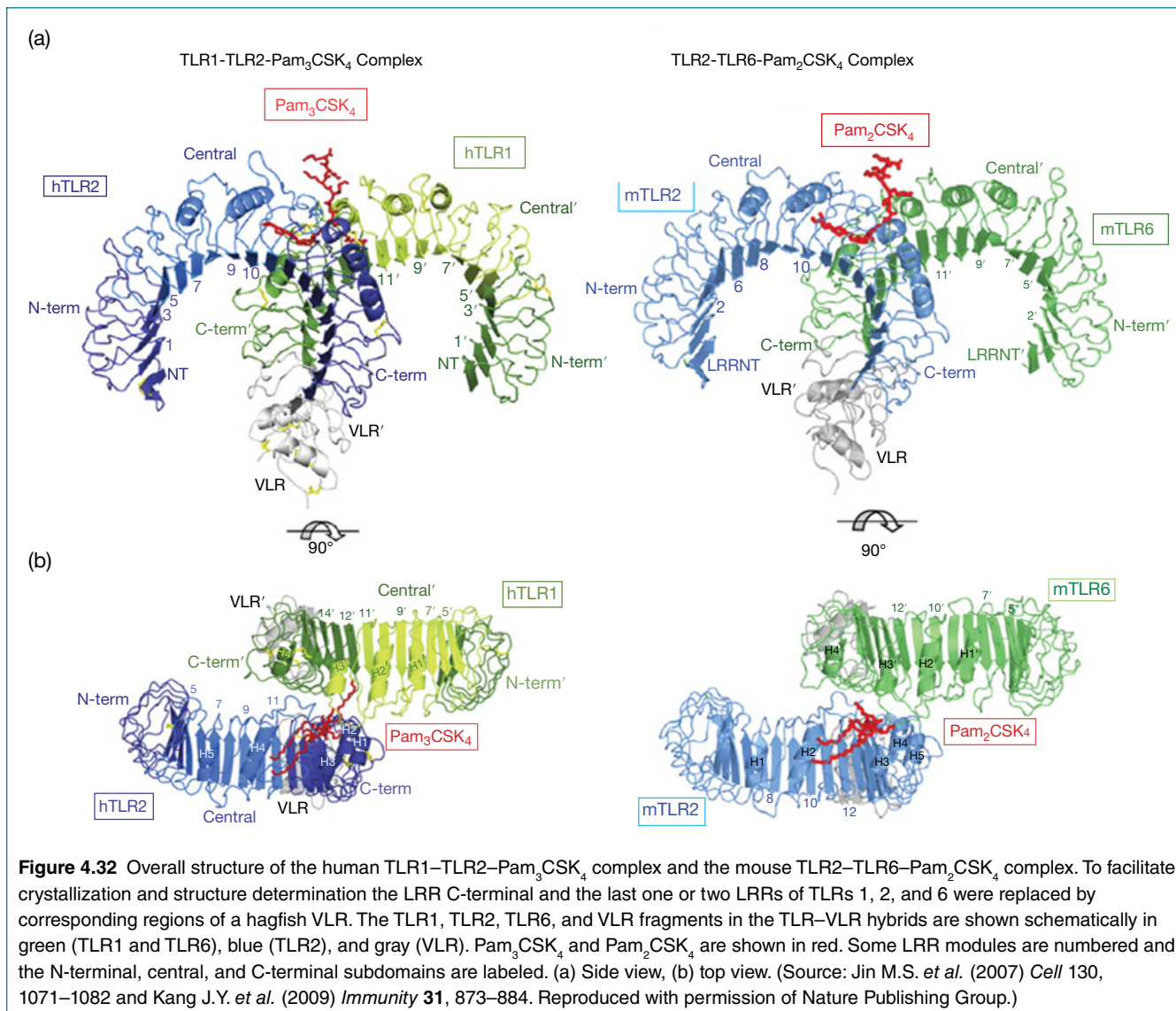
to accommodate the first two fatty acid chains of a triacylated lipoprotein, while the third acyl chain fits into a similar but smaller pocket on TLR1. The bound triacylated ligand now effectively acts as a *bridge* to pull both TLRs close together, allowing hydrophobic residues that surround the binding pockets on both TLRs to form hydrogen bonds that further stabilize the interaction, pulling both TLRs closer together (Figure 4.32). These ligand–TLR and TLR–TLR interactions result in dimerization of TLR1 and TLR2 at their C-termini, forming the distinctive “m shape” that facilitates localization of intracellular TIR domains.

Although TLR1/2 complexes efficiently bind triacylated lipoproteins, why are TLR2/6 complexes specific for diacylated ligands? The answer lies in a number of important structural differences between TLR1 and TLR6 in their ligand-binding and dimerization surfaces. Whereas TLR1 can accommodate an acyl chain in its C-terminal ligand-binding pocket, this pocket in TLR6 is partially *blocked by the bulky side chains of two phenylalanine residues*, reducing the pocket size by half and restricting ligand entry. Indeed, mutation of this region of TLR6 to mimic that found in TLR1 allows TLR6 to efficiently bind triacylated ligands, underlying the importance of these C-terminal phenylalanine residues in conferring specificity for diacylated lipoproteins. Although TLR6 lacks a ligand-binding pocket that could accommodate an acyl chain, it makes up for it in a superior ability to bind the peptide part of diacylated lipoproteins. As in the TLR1/2 complex, the two acyl chains of the lipopeptide are buried in the C-terminal pocket of TLR2, while the exposed peptide region of the ligand forms a number of strong hydrogen bonds with both TLR2 and TLR6 (Figure 4.32). In addition, an extensive region on TLR6 also makes direct contact with TLR2, forming stable hydrogen bonds that account for an *increase in protein–protein interaction of at least 80%* when compared with TLR1/2. These interactions combine to drive TLR2 and TLR6 close enough together for dimerization and intracellular signaling to occur.

Although we have focused on the extracellular TLR domain interactions that are brought about by ligand binding, the associated re-orientation of intracellular domains required to drive signaling is equally as important and it is to this that we will next turn our attention.

Dynamic structural rearrangements propagate intracellular TLR signaling

Regardless of the nature of ligand-induced dimerization of individual TLR ectodomains, dimerization at the C-termini re-orientates the receptors such that the *intracellular TIR domains* co-localize and undergo the dimerization required to recruit TIR domain-containing adaptors. Interestingly, extensive artificial truncation of TLR ectodomains triggers receptor auto-activation, which suggests that in their unbound forms, the ectodomains may act to inhibit an intrinsic tendency for the transmembrane and intracellular domains to dimerize. There are five TIR domain-containing adaptors that transmit



TLR signals into the cell, with **MyD88** required at a proximal level for the signaling of all TLRs except TLR3, which uses **TRIF** exclusively. In the case of TLR4, ligand binding promotes ectodomain dimerization, allowing the TIR domains to dimerize and recruit six molecules of MyD88, in conjunction with the bridging molecule **MyD88 adaptor-like protein (MAL)**. Close contact between the death domains of MyD88 is then thought to facilitate recruitment of four molecules of the death domain-containing adaptor **IRAK4**, which in turn, recruits four molecules of **IRAK2**, forming a higher order, column-like structure that has been dubbed the **Myddosome**, which is responsible for activating NFκB.

TIR domain structure can be subdivided into a central β-sheet, organized into four or five parallel β-strands (the βA–βE strands), with five α-helices (αA–αE helices), connected to the edges of the sheet by a series of loops. Some of these loops play a critical role in signal transduction, such as the **BB loop** that

joins the βB strand of the β-sheet with the αB α-helix. A polymorphism in this region in TLR4 in the CHC3H/HeJ strain of laboratory mice completely kills signaling from the receptor and renders these mice incapable of responding to LPS. Although dimerized TIR domains have proved difficult to crystallize, mutational and inhibitor studies have shed light on the method of TIR domain dimerization, with the BB loop of adjacent TIRs predicted to form an extensive interface. In addition, regions within the BB loop also make direct contact with the TIR domain of MAL, which acts as a bridging molecule to stabilize TLR4–MyD88 interaction.

TLR4 can also signal through the TIR domain-containing adaptor **TRIF**, in conjunction with the bridging molecule TRIF-related adaptor molecule (**TRAM**), to drive activation of IRF3 and expression of interferon genes. TRAM is recruited to TLR4 only after receptor endocytosis, suggesting that a possible conformational change in the receptor, driven by the acidic

environment of the endosome, may be required for TRAM binding and subsequent TRIF recruitment. Interestingly, the TIR domain of TLR3, which signals exclusively through TRIF, contains an alanine in the BB loop, rather than a proline like all the other TLRs, and mutation of this residue in TLR3 to proline changes specificity of TLR3 from TRIF to MAL/MyD88, with associated NF κ B signaling as opposed to IRF-dependent events.

MyD88 and TRIF form higher order complexes

In addition to a TIR domain, MyD88 also contains a *death domain (DD)*, common in proteins associated with apoptosis as well as immunity. The MyD88 DD provides a platform for recruitment of the DD-containing IRAK4, which in turn recruits IRAK2 via DD interactions. Death domains bestow on these proteins the ability to form hetero-oligomers and the crystal structure of the MyD88–IRAK4–IRAK2 complex has illuminated the impressively ordered nature of this signaling platform (Figure 4.33). Six–eight molecules of MyD88 recruit four molecules of IRAK4, which in turn recruit four molecules of IRAK2 in a *helical, three-layered complex* called the Myddosome, driven by DD–DD interactions. The importance of this complex for TLR signaling is illustrated by a naturally occurring polymorphism in the DD of MyD88 that renders these complexes defective for both signaling and Myddosome formation.

In contrast to MyD88, the larger TRIF molecule lacks a DD, instead containing an α -helical N-terminal domain (TRIF-NTD) that is thought to autoinhibit activation of the resting TRIF protein by obscuring the binding sites of down-

stream adaptors. Binding of TRIF to TLR3 or TLR4/TRAM displaces the TRIF-NTD and frees up a *proline-rich region* in the protein, which facilitates recruitment of tumor necrosis factor receptor-associated factor 2 (TRAF3) and TANK-binding kinase 1 (TBK1) for activation of IRFs. In addition, the TRIF receptor-interacting protein (RIP) homotypic interaction motif (RHIM) is also liberated to recruit RIP kinase 1, resulting in both FADD-dependent apoptosis and NF κ B activation. Crystal structures of the TRIF complexes have not yet been resolved to answer the question of whether or not they form higher order complexes like the Myddosome, but the current thinking is that a similar TRIF-containing complex may be formed.

C-type lectin-like receptors detect fungal antigen

C-type lectin-like receptors (CLRs) form a large and varied family of receptors that share in common a *C-type lectin-like domain (CTLD)* and function in a variety of scenarios, from cell–cell adhesion to immune signaling and apoptosis. Although the CTLD bears structural homology to the carbohydrate-binding domains found in carbohydrate-binding proteins, CTLDs are more varied and are not necessarily restricted to carbohydrate ligands. This family of receptors can be loosely subdivided by their requirement for calcium for functional ligand binding and on the type of intracellular signaling domain that can possess activating *ITAMs* or inactivating *ITIMs*. Ligand recognition and signal transduction by activating CLRs is broadly similar to the TLR scenario; ligand binding promotes receptor ectodomain dimerization, which then dimerizes and activates the intracellular ITAM motifs to recruit

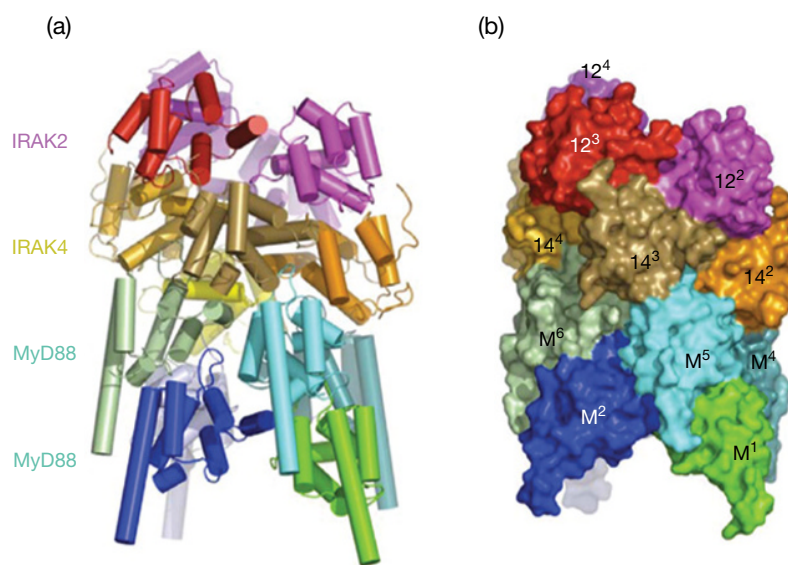


Figure 4.33 Myddosome structure. (a) Ribbon diagram of Myddosome structure, with the six MyD88 molecules in cold colors, the four IRAK4 molecules in earth-tone colors, and the four IRAK2 molecules in warm colors. (b) Surface diagram of the complex with each subunit labeled using the same color coding as in (a). M, MyD88; I4, IRAK4; I2, IRAK2. (Source: Lin S.C. *et al.* (2010) *Nature* **465**, 885–890. Reproduced with permission of Nature Publishing Group.)

ITAM-containing adapter molecules such as Syk kinase, to promote activation of proinflammatory transcription factors such as NFκB.

Although many members of the CTLD family bind a variety of carbohydrates from a number of different microorganisms (e.g., dectin-1 binds β-glucan and dectin-2 recognizes mannose) other members, such as the lipid-binding mincle, can also bind noncarbohydrate ligands. The fungal β-glucan-binding receptor dectin-1 is the best-characterized CTLD receptor and we will now look more closely at its mode of action.

Dectin-1 recognizes fungal β-glucan

Immune responses to fungal infections are mediated mainly by CTLD receptors, with the detection of β-glucans by dectin-1 playing a particularly important role in antifungal immunity. Mice deficient in this receptor display marked defects in immune cell infiltration during fungal challenge and are highly susceptible to infection with *Candida albicans*, while dectin-1 also detects β-glucans from a range of other fungi, including *Saccharomyces*, *Penicillium*, and *Aspergillus*. As highly conserved and essential components of the cell wall of certain fungi and baker's yeast, β-glucans certainly fit the bill as classical PAMPs. Dectin-1 can recognize **β-1,3 and β-1,6-linked glucans** from fungi, plants, and bacteria, with the best-characterized ligand, zymosan from yeast cell walls, binding with high affinity. The expression of dectin-1 on dendritic cells, monocytes, macrophages, and neutrophils places it on the front line of antifungal immunity, where receptor activation can trigger pathogen phagocytosis or the generation of antifungal cytokines and chemokines.

With a single extracellular CTLD, a transmembrane region and a cytoplasmic ITAM, ligand binding is thought to promote dimerization of the dectin-1 ectodomain, required to activate intracellular ITAMs. Unlike other members of the CTLD receptor family, ligand binding occurs in the absence of calcium. Crystal structure of the extracellular portion of dectin-1 illustrates that it adopts a similar conformation to other CTLD-containing receptors, with two antiparallel β-sheets and two α-helices, with the N- and C-termini in close proximity (Figure 4.34). Sequence analysis has highlighted a number of surface hydrophobic residues that could play a role in ligand binding, and mutational studies have identified two residues,

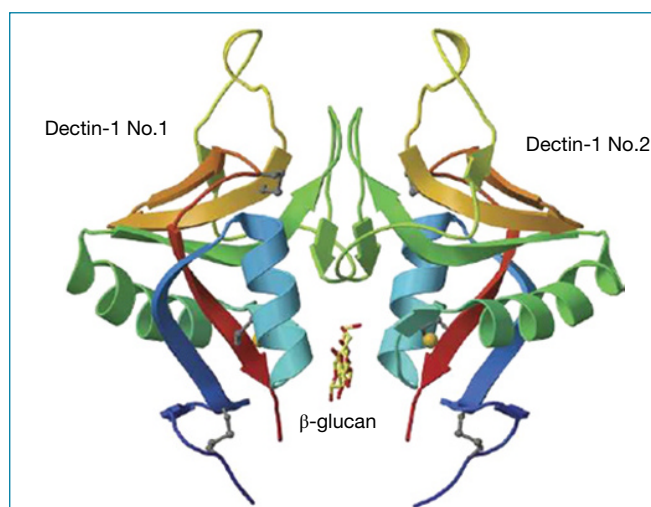


Figure 4.34 Two dectin-1 monomers form a dimer into which a short β-glucan binds. A cartoon diagram of the dectin-1 dimer, with each monomer colored from blue at the N-terminus to red at the C-terminus. (Source: Brown J. *et al.* (2007) *Protein Science* **16**, 1042–1052. Reproduced with permission of Wiley.)

Trp221 and **His223** in the third β-sheet of the CTLD, as particularly important for ligand recognition. Mutation of these residues to an alanine blocked the interaction of β-glucan with the receptor, while a dectin-1 antibody that efficiently inhibited β-glucan binding failed to bind to the W221A mutant, suggesting the region plays a key role in ligand interaction. This region adopts a shallow hydrophobic groove in the crystal structure of dectin-1, but no ligands were observed binding in this pocket, possibly due to technical constraints in achieving crystallization of β-glucan ligands of sufficient size. Indeed, cell-based studies have suggested that the minimum size of β-glucan sufficient to bind the receptor is no smaller than 10-mer, which could certainly be accommodated in this groove. Although the current crystal structure is inconclusive, it remains likely that β-glucan binding acts to bridge adjacent dectin-1 molecules to facilitate ITAM dimerization and recruitment of Syk kinase and, potentially, Raf, which can both drive immune signaling through NFκB activation. Activated Syk also drives calcium-dependent outcomes such as NFAT activation, with associated cytokine secretion.

The B-cell surface receptor for antigen

- The B-cell inserts its Ig gene product containing a transmembrane segment into its surface where it acts as a specific receptor for antigen.
- Specific antigen induces the formation of B-cell receptor (BCR) microclusters made up of between 50 and 500 receptors that appear to represent the active form of the BCR.
- The surface Ig is complexed with the membrane proteins Ig-α and Ig-β that become phosphorylated on cell

activation and transduce signals received through the Ig antigen receptor.

- The cytoplasmic tails of the Ig-α and Ig-β immunoreceptor tyrosine-based activation motifs (ITAMs), upon phosphorylation, can recruit phosphotyrosine-binding proteins that play important roles in signal transduction from the BCR.
- The B-cell co-receptor synergizes with the BCR to productively activate B-cells.

The T-cell surface receptor for antigen

- The receptor for antigen is a transmembrane dimer, each chain consisting of two Ig-like domains.
- The outer domains are variable in structure, the inner ones constant, rather like a membrane-bound Fab.
- Both chains are required for antigen recognition.
- Most TCRs can only recognize antigen when presented within the context of MHC molecules.
- CD4 and CD8 act as co-receptors, along with the TCR, for MHC molecules. CD4 acts as a co-receptor for MHC class II molecules and CD8 recognizes MHC class I molecules.
- Most T-cells express a receptor (TCR) with α and β chains (TCR2). A separate lineage (TCR1) bearing $\gamma\delta$ receptors is transcribed strongly in early thymic ontogeny but is associated mainly with epithelial tissues in the adult.
- The encoding of the TCR is similar to that of immunoglobulins. The variable region coding sequence in the differentiating T-cell is formed by random translocation from clusters of *V*, *D* (for β and δ chains), and *J* segments to give a single recombinant *V(D)J* sequence for each chain.
- Like the Ig chains, each variable region has three hyper-variable sequences that function in antigen recognition.
- The CD3 complex, composed of γ , δ , ϵ , and either ζ , $\zeta\eta$, or η , covalently linked dimers, forms an intimate part of the receptor and has a signal-transducing role following ligand binding by the TCR.

The generation of antibody diversity for antigen recognition

- Ig heavy and light chains and TCR α and β chains generally are represented in the germline by between 30 and 75 variable region genes, between 2 and 23 *D* segment minigenes (Ig heavy and TCR β and δ only) and 5–60 short *J* segments.
- TCR γ and δ chains are encoded by far fewer genes.
- Random recombination of any single *V*, *D*, and *J* from each gene cluster generates approximately 5.5×10^3 Ig heavy chain *VDJ* sequences, 350 light chains, 4.5×10^3 TCR α , 1×10^3 TCR β , but only 60 TCR γ and 72 TCR δ .
- Random interchain combination produces roughly 1.9×10^6 Ig, 4.5×10^6 TCR $\alpha\beta$, and 4.3×10^3 TCR $\gamma\delta$ receptors.
- Further diversity is introduced at the junctions between *V*, *D*, and *J* segments by variable combination as they are spliced together by recombinase enzymes and by the N-region insertion of random nontemplated nucleotide sequences. These mechanisms may be particularly important in augmenting the number of specificities that can be squeezed out of the relatively small $\gamma\delta$ pool.
- Useless or self-reactive receptors can be replaced by receptor editing.
- In addition, after a primary response, B-cells but not T-cells undergo high rate somatic mutation affecting the *V* regions.

iNKT cell receptors share features of innate and adaptive immune cell antigen receptors

- iNKT cells promote innate and adaptive immune responses.
- iNKT cells primarily detect a conserved repertoire of lipid-based antigen.
- There are two main types of iNKT, type I and type II cells, each with distinct ligand repertoires.
- iNKT cell receptors share features with both innate and adaptive antigen recognition receptors.
- Type I iNKT cell receptors are semi-variant, with a more constricted set of antigens and use germline-encoded regions to contact antigen.
- Type II iNKT cell receptors share more in common with conventional TCRs and have a more diverse range of ligands.

NK receptors

- NK cells bear a number of receptors with Ig-type domains and other receptors with C-type lectin domains. Members of both types of receptor family can function as inhibitory or activating receptors to determine whether the target cell should be killed.
- NK receptors are “hard-wired” (i.e., germline encoded) and achieve diversity through their sheer number rather than through somatic recombination.
- Loss of MHC class I molecules can provoke attack by NK cells.
- NK cells can also recognize ligands, typically nonclassical MHC-like molecules, which are upregulated by cells that suffer stress or DNA damage.

MHC

- MHC molecules act as receptors for antigen and present antigen-derived peptides to T-cells.
- Each vertebrate species has an MHC identified originally through its ability to evoke very powerful transplantation rejection.
- Each contains three classes of genes. Class I encodes 44 kDa transmembrane polypeptides associated at the cell surface with β_2 -microglobulin. Class II molecules are transmembrane heterodimers. Class III products are heterogeneous but include complement components linked to the formation of C3 convertases, heat-shock proteins, and tumor necrosis factors.
- MHC class I molecules present endogenous peptides synthesized by the cell, while MHC class II molecules present exogenous peptides that have been internalized by the cell.
- Several different types of MHC class I and class II molecules are expressed by all cells. MHC genes also display remarkable polymorphism. A given MHC gene cluster is referred to as a “haplotype” and is usually inherited *en bloc* as a single mendelian trait, although its

constituent genes have been revealed by cross-over recombination events.

- The highly polymorphic state of MHC class I and class II molecules has most likely arisen as a consequence of pathogen-driven selection and maximizes the number of pathogen-derived peptides that can be presented to the immune system.
- Classical class I molecules are present on virtually all cells in the body and present peptides to CD8⁺ cytotoxic T-cells.
- Class II molecules are particularly associated with B-cells, dendritic cells, and macrophages but can be induced on capillary endothelial cells and epithelial cells by interferon- γ . Class II molecules present peptides to CD4⁺ T-helpers for B-cells and macrophages.
- The two domains distal to the cell membrane form a peptide-binding cavity bounded by two parallel α -helices sitting on a floor of β -sheet strands; the walls and floor of the cavity and the upper surface of the helices are the sites of maximum polymorphic amino acid substitutions.
- Silent class I genes may increase polymorphism by gene conversion mechanisms.
- Nonclassical MHC molecules and MHC-like molecules have a number of functions, and include CD1 that presents lipid and glycolipid antigens to T-cells, and HLA-E that presents signal sequence peptides from classical class I molecules to the CD94/NKG2 receptor of NK cells.
- Nonclassical invariant MHC-like molecules probably represent the primordial forerunners to modern highly polymorphic MHC class I and II molecules.

Pathogen recognition receptors of the innate immune system provide the first line of detection of microbial antigen

- Germline-encoded pathogen recognition receptors (PRRs) detect conserved microbial components (PAMPs), which are essential for pathogen viability.
- Several different classes of PRRs have been characterized, including toll-like receptors (TLRs) and C-type lectin-like receptors.
- TLRs detect a wide range of extra- and intracellular PAMPs.
- TLRs are composed of an extracellular (ecto) domain, with a short transmembrane region and a cytosolic TIR domain required for signaling.
- All TLR ectodomains adopt a classical “horseshoe”-like shape, with ligand-induced dimerization of adjacent TLR ectodomains triggering dimerization of cytosolic TIR domains required for signaling.
- The TLR4/MD-2 complex detects microbial lipopolysaccharide.
- The TLR1/TLR2 complex detects triacylated lipoproteins, while TLR2/TLR6 complexes recognize the diacylated form.
- TIR domain dimerization recruits a higher order multiprotein complex called the Myddosome, which activates NF κ B.
- C-type lectin-like receptors (CLRs) detect a wide range of conserved microbial and self antigen.
- The CLR dectin-1 detects fungal β -glucan.



Now visit www.roitt.com to test yourself on this chapter.

FURTHER READING

- Biassoni R. (2009) Human natural killer receptors, co-receptors, and their ligands. In *Current Protocols in Immunology*. John Wiley & Sons Ltd, Chichester, Chapter 14 Unit 14.10.
- Botos I., Segal D.M., and Davies D.R. (2011) The structural biology of Toll-like receptors. *Structure* **19**, 447–459.
- Braud V.M., Allan D.S.J., and McMichael A.J. (1999) Functions of nonclassical MHC and non-MHC-encoded class I molecules. *Current Opinion in Immunology* **11**, 100–108.
- Call M.E. and Wucherpfennig K.W. (2005) The T cell receptor: critical role of the membrane environment in receptor assembly and function. *Annual Review of Immunology* **23**, 101–125.
- Chien Y., Meyer C., and Bonneville M. (2014) $\gamma\delta$ T cells: First line of defence and beyond. *Annual Reviews Immunology* **32**, 121–155.
- Clark D.A. (1999) Human leukocyte antigen-G: new roles for old? *American Journal of Reproductive Immunology* **41**, 117–120.
- de Wildt R.M.T., van Venrooij W.J., Winter G., Hoet R.M., and Tomlinson I.M. (1999) Somatic insertions and deletions shape the human antibody repertoire. *Journal of Molecular Biology* **294**, 701–710.
- Flajnik M.F. and Kasahara M. (2010) Origin and evolution of the adaptive immune system: genetic events and selective pressures. *Nature Reviews Genetics* **11**, 47–59.
- Garcia K.C. and Adams E.J. (2005) How the T cell receptor sees antigen – a structural view. *Cell* **122**, 333–336.

- Gay N.J., Symmons M.F., Gangloff M., and Bryant C.E. (2014) Assembly and localization of Toll-like receptor signalling complexes. *Nature Reviews Immunology* **14**, 546–558.
- Gleimer M. and Parham P. (2003) Stress management: MHC class I and class II molecules as receptors of cellular stress. *Immunity* **19**, 469–477.
- Godfrey D.I., Rossjohn J., and McCluskey J. (2008) The fidelity, occasional promiscuity, and versatility of T cell receptor recognition. *Immunity* **28**, 304–314.
- Hardison S.E. and Brown G.D. (2012) C-type lectin receptors orchestrate antifungal immunity. *Nature Immunology* **13**, 817–822.
- Horton R., Wilming L., Rand V., Lovering R.C., Bruford E.A., Khodiyar V.K., *et al.* (2004) Gene map of the extended human MHC. *Nature Reviews Genetics* **5**, 889–899.
- Hunt J.S. (2006) Stranger in a strange land. (Review on HLA-G and pregnancy) *Immunological Reviews* **213**, 36–47.
- Kelsoe G. (1999) V(D)J hypermutation and receptor revision: coloring outside the lines. *Current Opinion in Immunology* **11**, 70–75.
- Krangel M.S. (2009) Mechanics of T cell receptor gene rearrangement. *Current Opinion in Immunology* **21**, 133–139.
- Kumanovics A., Takada T., and Lindahl K.F. (2003) Genomic organization of the mammalian MHC. *Annual Review of Immunology* **21**, 629–657.
- Kumar V. and McNerney M.E. (2005) A new self: MHC class I-independent natural-killer cell self-tolerance. *Nature Reviews Immunology* **5**, 363–374.
- Longerich S., Basu U., Alt F., and Storb U. (2006) AID in somatic hypermutation and class switch recombination. *Current Opinion in Immunology* **18**, 164–174.
- Mak T.W. (1998) T-cell receptor, $\alpha\beta$. In *Encyclopedia of Immunology*, 2nd edn. (eds. Delves P.J. and Roitt I.M.). Academic Press, London, pp. 2264–2268. (See also article by Hayday A. and Pao W. on the $\gamma\delta$ TCR. In *Encyclopedia of Immunology*, 2nd edn. (eds. Delves P.J. and Roitt I.M.). Academic Press, London, pp. 2268–2278.)
- Matsuda F., Ishii K., Bourvagnet P., *et al.* (1998) The complete nucleotide sequence of the human immunoglobulin heavy chain variable region locus. *Journal of Experimental Medicine* **188**, 2151–2162.
- Matthews A.G. and Oettinger M.A. (2009) RAG: a recombinase diversified. *Nature Immunology* **10**, 817–821.
- MHC Sequencing Consortium (1999) Complete sequence and gene map of a human major histocompatibility complex. *Nature* **401**, 921–923.
- Moody D.B., Zajonc D.M., and Wilson I.A. (2005) Anatomy of CD1–lipid antigen complexes. *Nature Reviews Immunology* **5**, 387–399.
- Neefjes J.I., Jongsma M.L., Paul P., and Bakke O. (2011) Towards a systems understanding of MHC class I and MHC class II antigen presentation. *Nature Reviews Immunology* **11**, 823–836.
- Nemazee D. (2000) Receptor editing in B cells. *Advances in Immunology* **74**, 89–126.
- Parham P. (2008) The genetic and evolutionary balances in human NK cell receptor diversity. *Seminars in Immunology* **20**, 311–316.
- Prugnolle F., Manica A., Charpentier M., Guégan J.F., Guernier V., and Balloux F. (2005) Pathogen-driven selection and worldwide HLA class I diversity. *Current Biology* **15**, 1022–1027.
- Raulet D.H. (2004) Interplay of natural killer cells and their receptors with the adaptive immune response. *Nature Immunology* **5**, 996–1002.
- Rossjohn J., Pellicci D.G., Patel O., Gapin L., and Godfrey D.I. (2012) Recognition of CD1d-restricted antigens by natural killer T cells. *Nature Reviews Immunology* **12**, 845–857.
- Salio M., Silk J.D., and Cerundolo V. (2010) Recent advances in processing and presentation of CD1 bound lipid antigens. *Current Opinion in Immunology* **22**, 81–88.
- Sasaki Y. and Kurosaki T. (2010) Immobile BCRs: the safety on the signal trigger. *Immunity* **32**, 143–144.
- Schatz D.G. and Yanhong J. (2011) Recombination centres and the orchestration of V(D)J recombination. *Immunity* **28**, 304–314.

CHAPTER 5

Antigen-specific recognition

Key topics

■ What antibodies see	140
■ Identifying B-cell epitopes on a protein	143
■ Thermodynamics of antibody–antigen interactions	144
■ Specificity and cross-reactivity of antibodies	148
■ What the T-cell sees	148
■ Processing of intracellular antigen for presentation by class I MHC	150
■ Processing of extracellular antigen for class II MHC presentation follows a different pathway	151
■ Cross-presentation of antigens	154
■ The nature of the “groovy” peptide	154
■ The $\alpha\beta$ T-cell receptor binds to a combination of MHC and peptide	156
■ T-cell recognition of non-protein antigens	158
■ Antigen recognition by $\gamma\delta$ T-cells	159
■ Superantigens are extremely powerful activators of T-cells	162
■ Why do $\alpha\beta$ T-cells need to recognize antigen in such a complex way?	163

Just to recap ...

The acquired immune responses mounted by lymphocytes depend upon specific recognition of antigen by the B-cell receptor (BCR, a transmembrane version of the antibody molecule) or the T-cell receptor (TCR). Following clonal selection the antigen-specific lymphocytes undergo proliferation to produce sufficient numbers of effector cells and also to generate memory cells. In the case of B-cells the main effector cells are the plasma cells that secrete a soluble version of the same antibody that was used as the BCR on the original B-cell. In the case of T-cells the effector cells are cytokine-secreting helper or regulatory cells, or cell-killing cytotoxic cells.

Introduction

In acquired immunity, specific antigens are recognized by two classes of molecules: (i) **antibodies**, present either as soluble proteins or as transmembrane molecules on the surface of

B-cells; and (ii) **T-cell receptors**, present as transmembrane molecules on the surface of **T-cells**. Antibodies recognize antigens on the outside of pathogens or as soluble material such as toxins, whereas $\alpha\beta$ T-cell receptors recognize peptides in the context of **MHC** molecules on the surface of host cells. Antibodies can thus be thought of as scanning for foreign material directly whereas T-cells (particularly cytotoxic T-cells) are scanning for cells that are infected with pathogens.

What antibodies see

Antibodies recognize molecular shapes (epitopes) on antigens. Generally, the better the fit of the epitope (in terms of geometry and chemical character) to the antibody combining site, the more favorable the interactions that will be formed between the antibody and antigen and the higher the affinity of the antibody for antigen. The affinity of the antibody for the antigen is one of the most important factors in determining antibody efficacy *in vivo*.

Epitopes come in a huge variety of different shapes, as do antibody combining sites. Protein surfaces are typically recognized by a complementary surface in the antibody combining site, as illustrated in Figure 5.1 that shows how an antibody recognizes an epitope on the human epidermal growth factor receptor HER-2. The extent of complementarity of the interacting surfaces is readily appreciated.

The area of antigen that contacts antibody is referred to as a footprint and is typically between about 4 and 10 nm². Footprints are of somewhat different sizes and irregular shapes; a projection of a 2.5 × 2.5 nm square onto a series of protein antigens gives an appreciation of the approximate size of typical antibody footprints (Figure 5.2).

Antibodies recognize a topographic surface of a protein antigen. Most usually, key residues in the epitope will arise from widely different positions in the linear amino acid sequence of the protein (Figure 5.3). This follows because of the manner in which proteins are folded: the linear sequence typically snakes from one side of the protein to the other a number of times. Such epitopes are described as **discontinuous**. Occasionally, key residues arise from a linear amino acid sequence. In such cases, the antibody may bind with relatively high affinity to a peptide incorporating the appropriate linear sequence from the antigen. Furthermore, the free peptide may inhibit the antigen binding to the antibody. The epitope in such cases is described as **continuous**. An example of a continuous epitope would be a loop on the surface of the protein for which an antibody recognized successive residues in the loop. It should be noted, however, that an antibody that recognizes a continuous epitope does not bind a random or disordered structure. Rather it recognizes a defined structure that is found in the complete protein but can readily be adopted by the shorter peptide. The structure of an antibody that recognizes a linear epitope in complex with a peptide that contains the epitope is shown in Figure 5.4; note that the structure of the peptide is largely helical in this example.

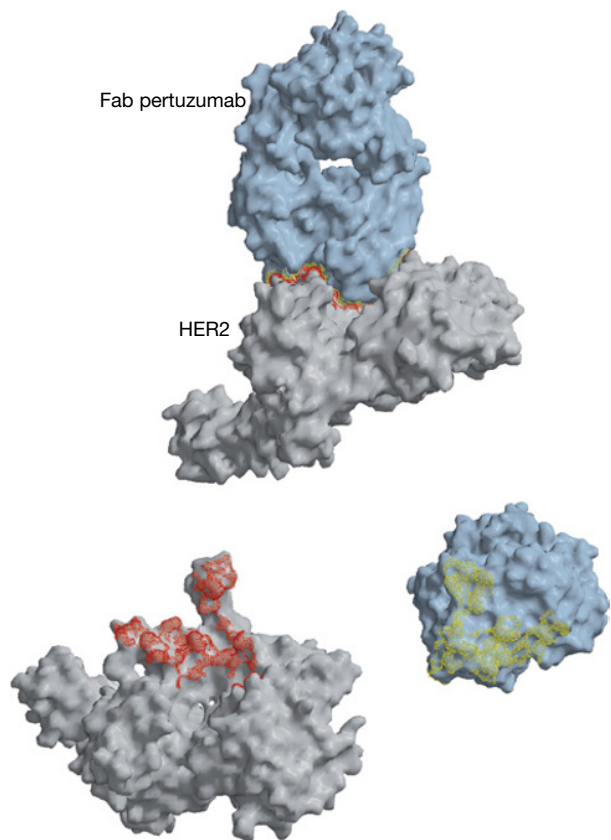


Figure 5.1 Complementarity of the antibody combining site and the epitope recognized on the antigen. The structure of the complex of the Fab of the antibody pertuzumab and its antigen HER2 is shown. HER2, the human epidermal growth factor receptor, is overexpressed on some breast cancer cells and pertuzumab is an antibody, similar to Herceptin®, with potential as a therapeutic against breast cancer. Below, the two molecules are shown separately with the interaction footprint shown on each. (Source: Robyn Stanfield. Reproduced with permission.)

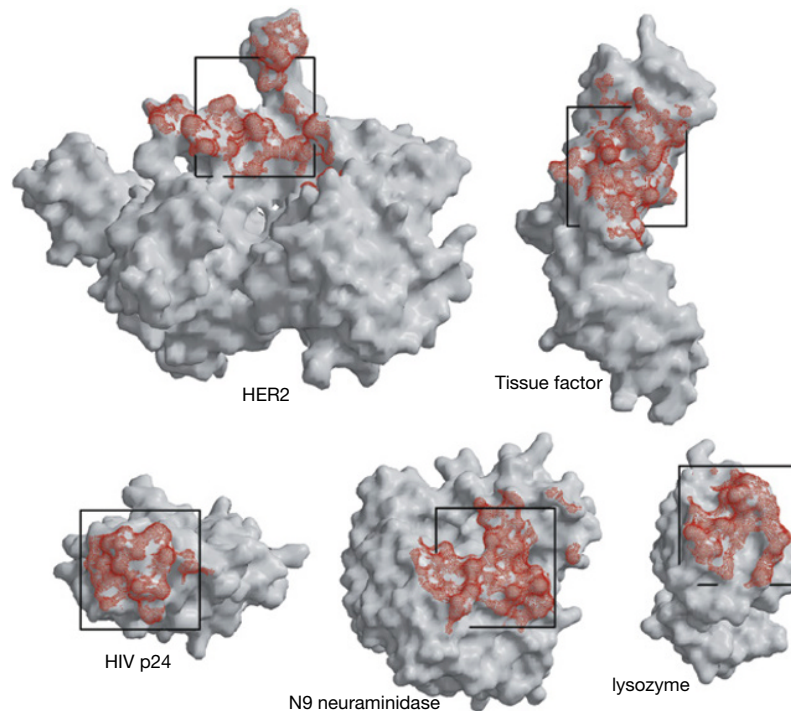


Figure 5.2 Antibody footprints (red) on a range of antigens. These footprints are determined from crystal structures of the antigens with antibody bound. The footprints are irregular but can be very roughly represented as a square of dimensions 2.5×2.5 nm as shown. (Source: Robyn Stanfield. Reproduced with permission.)

The antibody complementarity determining regions (CDRs) contact the epitope

The antibody combining site can vary greatly in shape and character depending upon the length and characteristics of the CDRs. Generally most or all of the CDRs (although by no means all of the residues making up a CDR) contribute to antigen binding but their relative contributions vary. The heavy chain CDRs, and particularly CDR H3, tend to contribute disproportionately more to antigen binding. The CDR H3 in human antibodies can be quite long and has a finger-like appearance that could be used to bind into cavities on the antigen. The combining site of antibodies against smaller molecules such as carbohydrates and organic groups (haptens) are often more obviously grooves or pockets rather than the extended surfaces typically found in antiprotein antibodies. It should also be noted that framework region (FR) residues can also contribute to antigen binding. For highly somatically mutated antibodies, such as those to HIV, quite extensive contacts between FR residues and the viral surface antigen are observed.

Structural changes and conformational rearrangements can occur in antibodies or antigens on interaction. In other words, on some occasions, the relationship between antibody and antigen will be like a “lock and key” but on other occasions the lock or key or both can be deformed to make a good fit. For the antibody, possible conformational changes include side-chain rearrangements, segmental movements of CDRs or of the

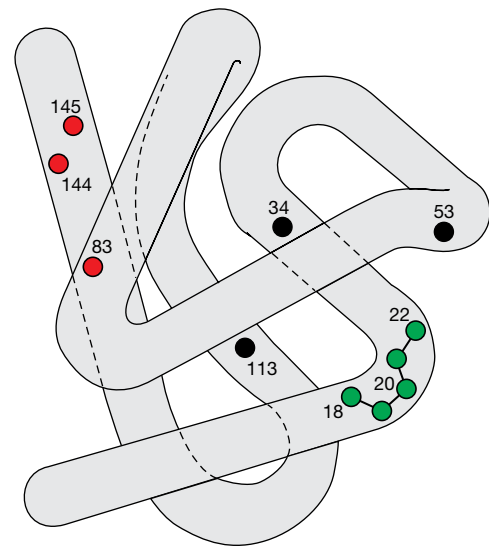


Figure 5.3 Residues contributing to epitopes on the folded peptide chain of myoglobin. Amino acid residues 34, 53, and 113 (black) contribute to the binding of a monoclonal antibody (mAb) and residues 83, 144, and 145 to the binding of another mAb (red). Both epitopes are clearly discontinuous. By contrast, a third mAb binds to residues 18–22 (green). The mAb binds to isolated peptides containing the sequence corresponding to residues 18–22. The epitope is described as continuous. Much of the myoglobin structure is in α -helical conformation. (Source: Adapted from Benjamin D.C. *et al.* (1986) *Annual Review of Immunology* 2, 67.)

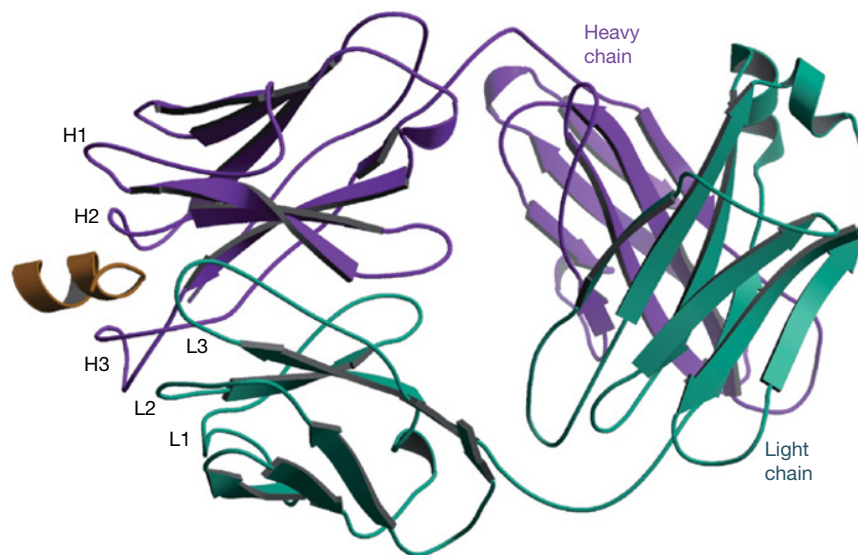


Figure 5.4 The structure of an antibody bound to a peptide corresponding to a linear epitope. The antibody 4E10 neutralizes HIV by binding to a linear epitope on the glycoprotein gp41 on the surface of the virus. The antibody binds to peptides containing the amino acid sequence NWF_DIT and peptides containing this sequence can inhibit the binding of 4E10 to gp41. The structure of the Fab fragment of 4E10 bound to a peptide (gold) containing the NWF_DIT sequence shows the peptide adopts a helical conformation. It is likely that the antibody recognizes its epitope in a helical conformation on the virus. (Source: Rosa Cardoso. Reproduced with permission.)

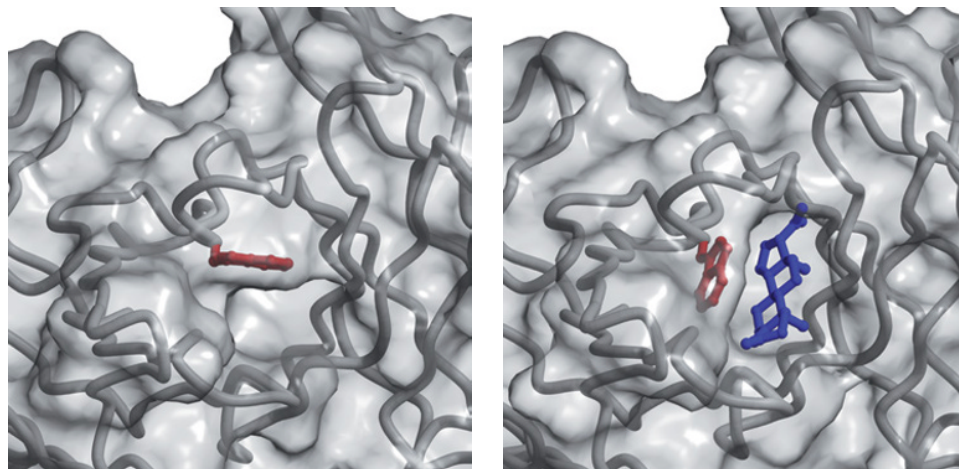


Figure 5.5 Conformational change in an antibody combining site. (a) An anti-progesterone antibody has a very hydrophobic pocket that is filled by a tryptophan residue (colored red) in the free antibody. (b) To bind progesterone (dark blue), the tryptophan residue swings out of the pocket and the antigen gains access. (Source: Robyn Stanfield. Reproduced with permission.)

main-chain backbone, and rotation of the V_L - V_H domain upon antigen binding. Large changes in the conformation of the CDR H3 have been documented in crystal structures of Fab complexes. As shown in Figure 5.5, an antibody to progesterone has a very hydrophobic combining pocket, which is normally filled with a tryptophan from the CDR H3. Antigen binding involves this residue moving out of the pocket, the antigen molecule moving in and the tryptophan stabilizing the antigen binding.

As more and more structures have been solved it has become clear that antibody–antigen interactions come in all shapes and

sizes with few general rules. It is important to bear in mind that high-affinity antibodies evolve in each individual following rounds of mutation and selection. There are multiple ways in which high-affinity recognition of an antigen can be achieved, and indeed no two antibody–antigen interactions are exactly the same.

Antigens versus immunogens

An epitope on an antigen may bind very tightly to a given antibody but it may elicit such antibodies infrequently when the antigen is used to immunize an animal. In other words, there

may be a perfectly good site on a pathogen for antibody binding but the antibody response to that site is so poor it cannot contribute to antibody protection against the pathogen. We say that the site has low immunogenicity and the consequences can clearly be great.

An extreme example of the distinction between the ability to be recognized by an antibody (which we will term antigenicity) and the ability to elicit antibodies when used to immunize an animal (which we will term immunogenicity) is provided by experiments using small molecules known as haptens such as *m*-aminobenzene sulfonate. Immunization with free hapten produces no antibodies to the hapten (Figure 5.6). However immunization with hapten groups linked to a protein carrier generates antibodies that react with high affinity to hapten alone or linked to a molecule other than the carrier. It is logical to refer to the hapten as the antigen and the hapten–protein complex as the immunogen, although strictly the word “antigen” is derived from “antibody generating” substance.



Identifying B-cell epitopes on a protein

How many epitopes are there on a single protein? This depends upon how one defines an epitope. For the small protein lysozyme (molecular weight $\sim 14\,300$ daltons), the structures of three non-competing monoclonal antibodies in complex with the protein antigen have been determined. They have minimally overlapping footprints that cover just under half of the surface of the protein (Figure 5.7). One could extrapolate that a small protein such as this could have of the order of between three and six non-overlapping epitopes recognized by noncompeting antibodies.

The specificity of a given antibody could then be defined by its ability to compete with the three to six “prototype” antibodies. In practice, this is often done; an antibody is said to be directed against a given epitope if it competes with a prototype antibody

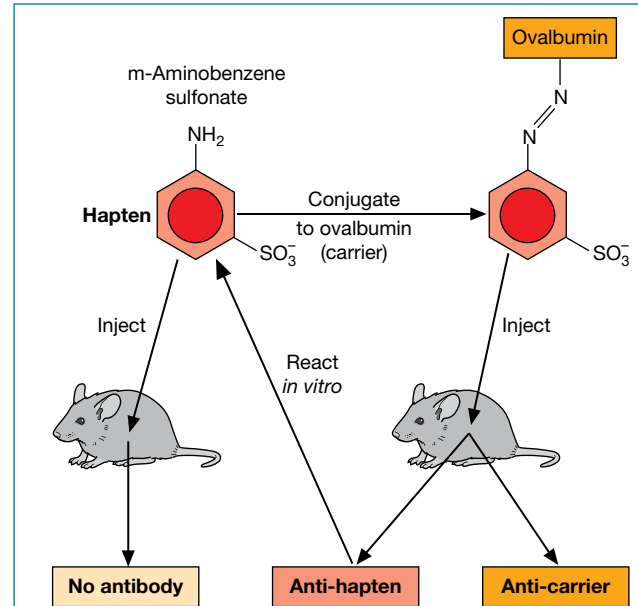


Figure 5.6 Antigenicity and immunogenicity. A free small molecule hapten will not induce antibodies if injected in to an animal. However, high-affinity antibodies specific for the free hapten can be obtained by injecting the hapten conjugated to a protein carrier molecule such as ovalbumin.

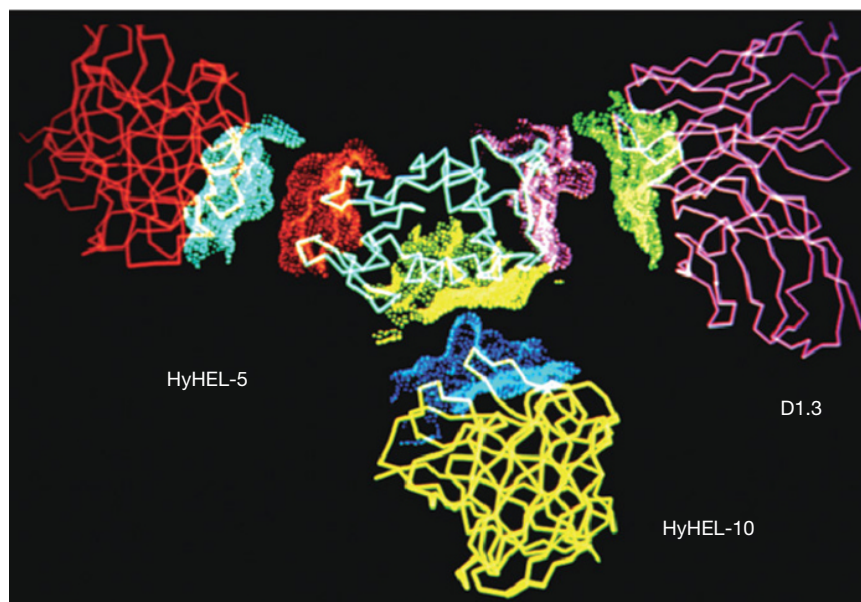


Figure 5.7 Three epitopes on the small protein lysozyme. The crystal structures of lysozyme bound to three antibodies (HyHEL-5, HyHEL-10, and D1.3) have been determined. In the figure, the Fv fragment of each antibody is shown separated from lysozyme to reveal the footprint of interaction in each case. The three epitopes are nearly non-overlapping with only a small overlap between HyHEL-10 and D1.3. (Adapted from Davies D.R. *et al.* (1990) *Annual Review of Biochemistry* 59, 439. Reproduced with permission of Annual Reviews.)

of known specificity. This is, of course, a rather simplistic view as many antibodies will compete with more than one prototype antibody allowing a more sophisticated B-cell epitope map to be constructed. An even more sophisticated map can be constructed by scanning mutagenesis of the antigen. In the latter case, single positions in the antigen can be substituted by differing amino acids (usually alanine – hence the term “alanine scanning mutagenesis”) and the effects on antibody binding measured (see Figure 5.10). At this greater level of precision, it is likely that no two antibodies will give exactly the same footprint, and therefore no two antibodies recognize exactly the same epitope.

What determines the strength of the antibody response to a given epitope on a protein? There appear to be a number of factors involved. Perhaps the most important is the accessibility of the epitope on the protein surface. Loops that protrude from the surface of the folded protein tend to elicit particularly good antibody responses. The surface of influenza virus is decorated by the hemagglutinin protein (HA) (Figure 5.8a). On infection with the virus or vaccination with materials containing HA, antibodies are elicited, particularly to the “top” of the structure that neutralize the virus and protect against re-infection or even infection itself in the case of a vaccine. However, mutations in the targeted regions allow the virus to “escape” from neutralizing antibodies and infect human hosts who were protected against the original form of the virus. Influenza epidemics thus directly reflect antibody targeting to certain preferred epitopes. Furthermore, vaccination tends to afford protection only against some strains of influenza virus and is typically administered on an annual basis. However, recently monoclonal antibodies have been described that neutralize many different strains of influenza virus (Figure 5.8a), so-called broadly neutralizing antibodies, and the epitopes recognized by these anti-

bodies might be targeted by a suitable designed “universal flu vaccine.”

HIV is another virus that exploits the tendency of the antibody system to respond to highly exposed variable regions on the viral surface protein to evade immune control. Following primary infection, it takes some time (weeks) for neutralizing antibodies to reach a level where they begin to inhibit virus replication. These antibodies are typically elicited to exposed regions on the virus. While these antibodies are being elicited, the virus has diversified (i.e., it has become a swarm of related viruses) through the errors associated with RNA to DNA transcription of this retrovirus. Among this swarm is a virus that has sequence changes in the epitopes targeted by the neutralizing antibody response that allow it to escape from the response. This new virus becomes predominant. Eventually a response is mounted to this virus and a second new virus emerges and so on. The antibody response chases the virus over many years but never appears to gain control. Nevertheless, again broadly neutralizing antibodies to HIV have been identified and are being intensely investigated for clues as to how to design an HIV vaccine, since such antibodies are precisely those that should offer protection against global circulating strains of HIV (Figure 5.8b).

One point worthy of note is that accessible loops on protein structures tend to be flexible. Therefore epitope dominance has also been associated with flexible regions of a protein antigen.

Thermodynamics of antibody–antigen interactions

The interaction of antibody and antigen is reversible and can be described by the laws of thermodynamics. In particular, the reaction

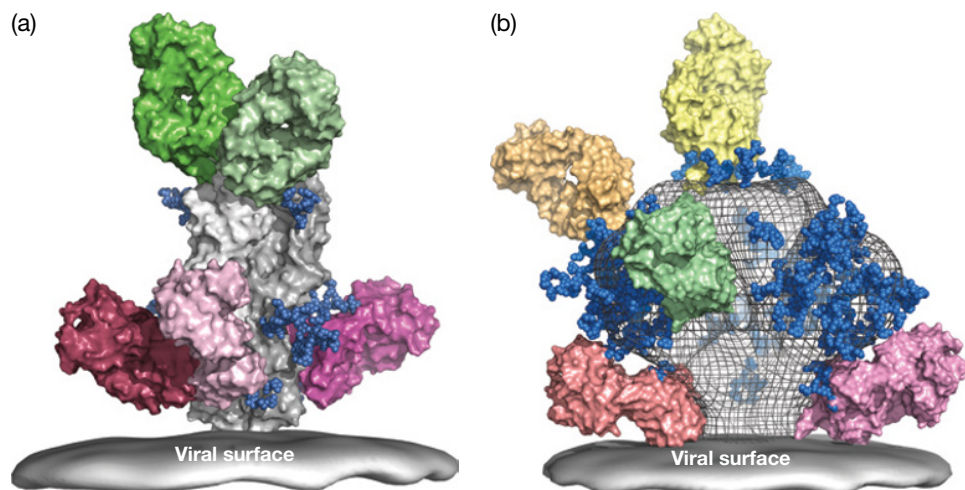
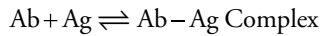


Figure 5.8 Antibodies bound to the surface glycoproteins of influenza virus and HIV. (a) A model of broadly neutralizing antibodies targeting relatively conserved epitopes on influenza virus hemagglutinin (HA). Natural infection and vaccination typically result in antibodies directed to highly variable epitopes on the top of the structure. However some antibodies (green) are able to recognize conserved elements associated with the sialic acid-binding site in this region. Other antibodies (pink) recognize conserved epitopes in the stem of HA. The antibodies shown are Fab fragments. *N*-linked glycans in blue. (b) A model of broadly neutralizing antibodies targeting conserved epitopes on the HIV envelope spike. Again natural infection typically elicits antibodies directed to highly variable epitopes toward the top of the structure, leading to strain-specific antibodies. The spike is very densely coated with sugars that hinder antibody recognition. Nevertheless, some antibodies do bind to conserved epitopes as shown. *N*-linked glycans in blue.



can be studied and the position of the equilibrium established under varying conditions. In other words, the amount of antibody bound to antigen under different conditions can be estimated. This is crucial information. If antibody coats a virus then it is likely that the virus will be prevented from entering target cells and infection will be avoided. If antibody can become attached to a bacterial cell in a high enough density then complement may be triggered and the cell killed.

The position of equilibrium is described by the association or binding constant, K_a :

$$K_a = \frac{[\text{Ab}-\text{Ag complex}]}{([\text{Ab}] \times [\text{Ag}])}$$

where square brackets indicate molar concentrations. The units of K_a are thus mols per liter, (M^{-1}), or $1/M$. If K_a is a large number then the equilibrium is far to the right and Ab–Ag complex formation is favored. Typically high-affinity antibodies have K_a values of the order of 10^8 – $10^{10} M^{-1}$. Some researchers prefer to think of binding in terms of a dissociation constant, K_d , simply defined as $1/K_a$ and having the units of M . High-affinity antibodies then have K_d values of the order of 10^{-8} – $10^{-10} M$. As a $K_d = 10^{-9} M$ corresponds to 1 nM, high-affinity antibodies are sometimes referred to as “nM binders.” Moderate affinity antibodies such as IgMs are often referred to as μM binders ($K_d = 1 \mu M$).

Another way to look at the binding equation is that if half the available antigen sites are occupied by antibody then $[\text{Ag}] = [\text{Ab}-\text{Ag complex}]$ and $K_a = 1/[\text{Ab}]$ or $K_d = [\text{Ab}]$. In other words, K_d is equal to the antibody concentration at which half of the antibody is bound. Thus for example a nM binding antibody will begin to complex antigen when its concentration is in the nanomolar range. The antibody will bind very little if it is only in the picomolar (10^{-12}) range of concentrations but will bind very effectively in the μM range. Similarly a μM antibody will be effective in the μM range of concentration but not the nM. For IgG, nM is roughly $0.15 \mu g/mL$ and mM is $150 \mu g/mL$. The average concentration of IgG in serum is about $12 mg/mL$. Clearly then, if we require that antibodies be present in serum at concentrations where they are going to be effective in binding antigen, many many more specificities can be covered by a set of nM binding (high-affinity) antibodies than a set of μM binding antibodies. Indeed, this seems to be largely how Nature operates outside of extreme immunization protocols in animal models. Thus we are mostly protected, at least against re-infection following a primary infection or vaccination, by high-affinity antibodies at relatively moderate concentrations.

In the above discussion, we implicitly assume that antibody–antigen interactions are monovalent, involving just one Fab arm of the antibody molecule. In fact they may well be multivalent, which complicates the issues somewhat, but the major points remain intact. We return to multivalency later.

Binding constants for antibody–antigen interactions are often estimated from ELISA measurements but now can be

determined with some precision by techniques such as surface plasmon resonance and isothermal calorimetry. For binding of antibodies to antigens on the cell surface, flow cytometry can give a good estimate of binding affinities.

The binding constant for a reaction is directly related to the energy accompanying the reaction by the equation:

$$\Delta G = -RT \ln K_a$$

where ΔG is called the free energy of the reaction, R is the gas constant, T is the temperature in K; and \ln is natural log = $2.303 \times \log_{10}$. ΔG is then another way of describing how far a reaction will be driven to the left or right at equilibrium under certain conditions. If $K_a = 10^9 M^{-1}$, ΔG approx. -12 kcal/mol ; if $K_a = 10^6 M^{-1}$, ΔG approx. -8 kcal/mol . The advantage of considering the ΔG is that it can help in beginning to understand the molecular forces that lead to antibody–antigen interaction. Thus the free energy of a reaction (ΔG) is the net effect of contributions from enthalpy (ΔH) and entropy (ΔS):

$$\Delta G = \Delta H - T\Delta S$$

The enthalpy is the heat of the reaction: the more heat is given out by the reaction (negative ΔH) the more it will be favored (negative ΔG). If heat has to be supplied to the reaction it is disfavored. The more entropy (or disorder) results from the reaction (positive ΔS), the more it is favored. For example, an antibody–antigen interaction would be favored by the formation of a H bond between the two molecules to the tune of approximately 1 – 3 kcal/mol . A salt bridge would provide a similar or slightly greater amount of energy. The reaction would also be favored by hydrophobic surfaces on the antibody and the antigen coming together because then water that was ordered around the hydrophobic faces would be released to increase entropy. It is estimated that burying 1 nm^2 of hydrophobic surface generates about 2.5 kcal/mol of binding energy. Some of the forces driving protein–protein interactions are summarized in Figure 5.9.

An epitope is often thought of in terms of the region of the antigen contacted by antibody, a picture provided from crystal structure studies of antibody–antigen complexes. However, it should be borne in mind that looking at contacts between antibody and antigen in a crystal structure does not tell us the contributions of individual interactions to the overall binding energy. This can be done by measuring the effects of scanning mutagenesis on antibody binding measured. The available data then suggest that only a few productive interactions (“hotspots”) dominate the energetics of binding; many interactions are neutral or detrimental to binding even in a high-affinity antibody–antigen pairing. In the interaction of an antibody with lysozyme, only about a third of the antibody contact residues actually contribute significantly to net binding (Figure 5.10).

A substitution in only one residue of antigen or antibody can be decisive in net binding of antibody to antigen. This can be readily appreciated intuitively. If a bulky residue replaces a small one in the epitope recognized, then the whole antibody–antigen interface may be disrupted. Pathogens typically evade antibodies by mutations in a small number of critical residues.

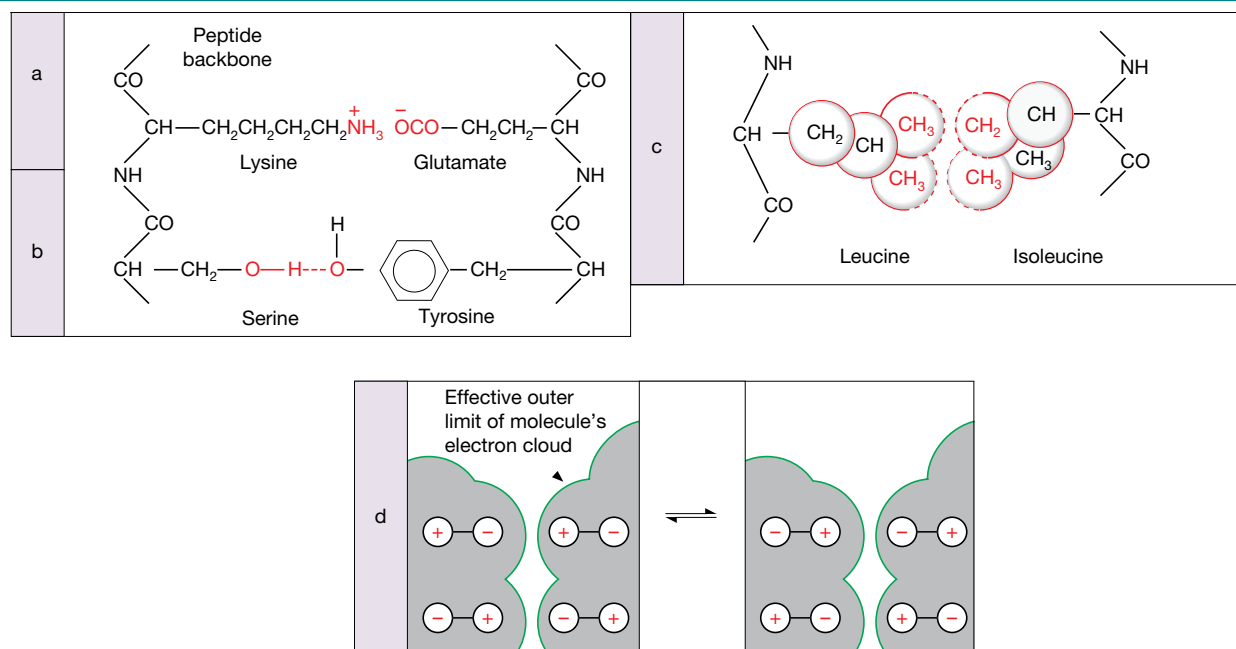


Figure 5.9 Protein–protein interactions. (a) Coulombic attraction between oppositely charged ionic groups on the two protein side-chains as illustrated by an ionized amino group (NH_3^+) on a lysine of one protein and an ionized carboxyl group (COO^-) of glutamate on the other. The force of attraction is inversely proportional to the square of the distance between the charges. Thus, as the charges come closer together, the attractive force increases considerably: if we halve the distance apart, we quadruple the attraction. Furthermore, as the dielectric constant of water is extremely high, the exclusion of water molecules through the proximity of the interacting residues would greatly increase the force of attraction. Dipoles on antigen and antibody can also attract each other. In addition, electrostatic forces may be generated by charge transfer reactions between antibody and antigen; for example, an electron-donating protein residue such as tryptophan could part with an electron to a group such as dinitrophenyl (DNP) that is electron accepting, thereby creating an effective +1 charge on the antibody and -1 on the antigen. (b) Hydrogen bonding between two proteins involving the formation of reversible hydrogen bridges between hydrophilic groups, such as OH , NH_2 , and COOH , depends very much upon the close approach of the two molecules carrying these groups. Although H bonds are relatively weak, because they are essentially electrostatic in nature, exclusion of water between the reacting side-chains would greatly enhance the binding energy through the gross reduction in dielectric constant. (c) Nonpolar hydrophobic groups, such as the side-chains of valine, leucine, and isoleucine, tend to associate in an aqueous environment. The driving force for this hydrophobic interaction derives from the fact that water in contact with hydrophobic molecules with which it cannot H bond will associate with other water molecules, but the number of configurations that allow H bonds to form will not be as great as that occurring when they are surrounded completely by other water molecules (i.e., the entropy is lower). The greater the area of contact between water and hydrophobic surfaces, the lower the entropy and the higher the energy state. Thus, if hydrophobic groups on two proteins come together so as to exclude water molecules, between them the net surface in contact with water is reduced and the proteins take up a lower energy state than when they are separated (in other words, there is a force of attraction between them). (d) van der Waals force: the interaction between the electrons in the external orbitals of two different macromolecules may be envisaged (for simplicity!) as the attraction between induced oscillating dipoles in the two electron clouds. The nature of this interaction is difficult to describe in nonmathematical terms, but it has been likened to a temporary perturbation of electrons in one molecule effectively forming a dipole, which induces a dipolar perturbation in the other molecule, the two dipoles then having a force of attraction between them; as the displaced electrons swing back through the equilibrium position and beyond, the dipoles oscillate. The force of attraction is inversely proportional to the seventh power of the distance and, as a result, this rises very rapidly as the interacting molecules come closer together.

Multivalency in antibody–antigen interactions

The binding of a monovalent Fab fragment to a monovalent antigen can be analyzed in a straightforward way as described above. This should also be true for the corresponding divalent IgG molecule interacting with the monovalent antigen. However, once we consider a divalent IgG (or multivalent antibody of any class) interacting with a multivalent antigen, the analysis of binding becomes more complex.

Consider IgG binding to an antigen that is expressed as multiple copies on a cell surface. If the antigen molecules are appropriately spaced and in an appropriate orientation, IgG may be able to bind divalently (Figure 5.11). This will lead to a higher affinity (often referred to as the avidity or functional affinity) of the IgG for the cell surface than the corresponding Fab. The “bonus effect” of divalent binding can be understood intuitively in terms of the tendency of the divalent IgG to stick better to the cell surface than the corresponding Fab. For the Fab to “fall off” the cell, a series of

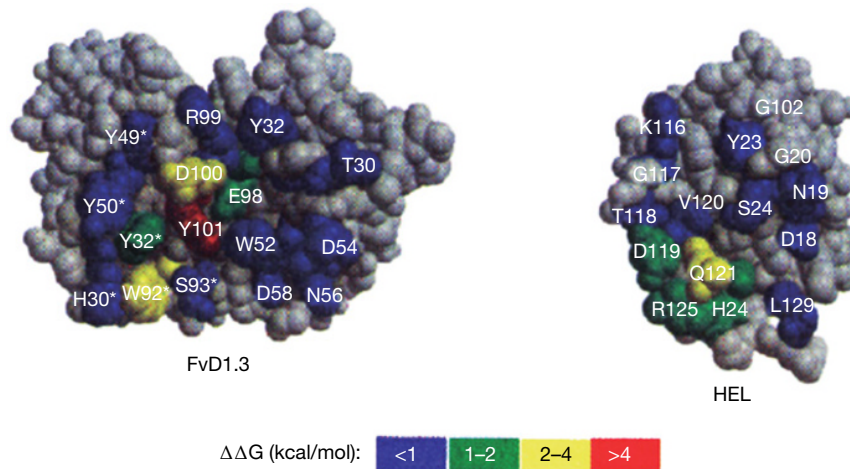


Figure 5.10 Energetic map of an antibody–antigen interface. The antibody D1.3 (single chain Fv (sFv) shown here) binds with high affinity to hen egg-white lysozyme (HEL) and the crystal structure of the complex has been solved (see Figure 5.7). The energetic contribution of contact residues for both antibody and antigen can be estimated by substituting the residue with the relatively “neutral” residue alanine. The effect can be expressed in terms of the loss of free energy of binding for the interaction on alanine substitution ($\Delta\Delta G$). A large positive value for $\Delta\Delta G$ shows that the alanine substitution has had a strong detrimental effect on binding and implies that the residue substituted forms a crucial contact in the interface between antibody and antigen. Clearly, most contact residues, particularly on the antibody, contribute little to the overall binding energy. There are clear “hotspots” on both antibody and antigen and the hotspot residues on the antibody side of the interaction correspond to those on the antigen side. (Adapted from Sundberg E.J. and Mariuzza R.A. (2002) *Advances in Protein Chemistry* **61**, 119. Reproduced with permission of Elsevier.)

interactions between a single antibody combining site and the antigen must be broken. For the IgG to fall off, the interactions in two antibody combining sites must be broken simultaneously; a lower probability event. The bonus effect can be thought of in terms of ΔG . Divalent binding will produce a more favorable ΔH because of the use of two antibody combining sites. However, an entropy price will be paid in constraining the Fab arms of the IgG molecule. The net effect in ΔG usually corresponds to an enhanced affinity of the order of 1- to 100-fold as the bonus effect. It should also be borne in mind that IgG may bind monovalently even to a multivalent antigen if the antigen molecules are inappropriately spaced or oriented. IgM is decavalent for antigen, which in theory could produce a huge bonus effect in functional affinity. In practice IgMs tend to be rather moderate affinity binders, suggesting limited use of multivalency and/or a high entropy price paid for multivalent binding.

One of the most dramatic effects of multivalent antibody interaction can be seen in the neutralization of toxins. Botulinum neurotoxins cause the paralytic human disease botulism and are considered a major potential bioterrorist threat. Monoclonal antibodies (mAbs) have been generated from phage libraries against the toxin. No single mAb protected mice against lethal challenge with toxin. However, a combination of three mAbs protected mice against a huge challenge with toxin. The difference could be attributed in part to a multivalency bonus effect (cooperative binding of the antibodies with more than one molecule of the toxin) that increased the functional affinities of the antibodies in to the pM range from the nM range in the individual mAbs. The origins of this effect are illustrated for a two-mAb combination in Figure 5.12.

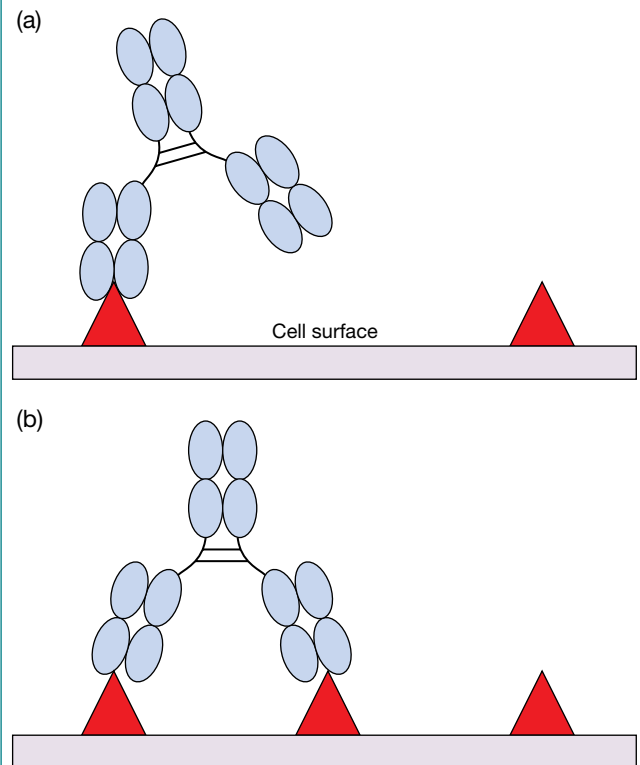


Figure 5.11 Divalent antibody binding to a cell surface. The affinity of an antibody that can bind divalently to a multivalent antigen (b), such as may be found on a cell surface, is enhanced relative to an antibody that can only bind monovalently (a).

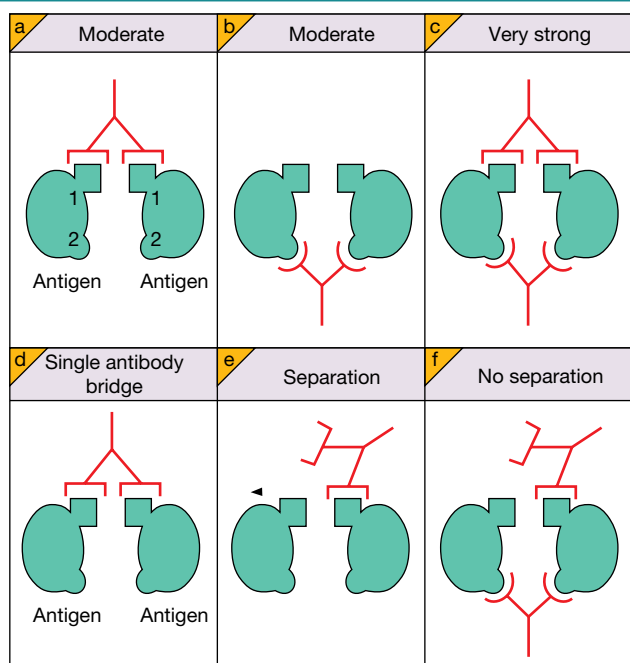


Figure 5.12 The bonus effect of multivalent binding in antibody neutralization of a soluble molecule such as a toxin. (a–c) It is found that two antibodies binding to non-overlapping epitopes on a soluble antigen may show considerably enhanced affinity as compared to the antibodies used separately (cooperative binding). (d,e) If only one antibody is present, dissociation of the complex requires only that the interaction between one antibody combining site and its epitope be disrupted. (f) If two antibodies are bound to antigen and one antibody-combining site–epitope interaction is lost as shown, the complex stays together and the released Fab arm is in a position to re-complex. In effect, the k_{off} values for the two antibodies are decreased in the complex and, if an Fab arm is dislodged, the k_{on} value is increased relative to a single bound antibody situation.

Specificity and cross-reactivity of antibodies

Specificity is a commonly discussed concept in the context of antibodies. It can have different meanings. Sometimes, it is used simply to indicate that the antibody has high affinity for antigen. Generally this means that the antibody has a combining site that fits very well to an epitope on the antigen and is much

less likely to fit other shapes very well. Therefore it is specific for the antigen. However, there may be other shapes that can be accommodated, especially if they are related to the antigenic epitope in composition or character. Most likely is that other molecules will be recognized with lower affinity. It is important to remember from the discussion above that antibodies will be functional at concentrations around their K_d values. So if an antibody has a nM affinity for a given antigen and is present at nM concentrations *in vivo*, cross-reactivities with other antigens in the sub- μM range are unlikely to be functionally significant unless those antigens are at high concentrations.

A second meaning that is attached to “specificity” is the ability to discriminate between molecules. This clearly overlaps with the discussion above but could also be applied to lower affinity antibodies. Thus in genomic studies there has been a demand for antibodies that can distinguish target proteins from many other proteins and identify the target proteins in a variety of assays. This has not necessarily required high affinity but has required good discrimination. Moderate-affinity antibodies selected from phage libraries have been used successfully in this arena.

What the T-cell sees

We have on several occasions alluded to the fact that the $\alpha\beta$ T-cell receptor sees peptide antigen associated with an MHC class I or II molecule on the surface of cells. Now is the time for us to go into the nuts and bolts of this relationship.

Haplotype restriction reveals the need for MHC participation

It has been established in “tablets of stone” that T-cells bearing $\alpha\beta$ receptors, with some exceptions, only respond when the antigen-presenting cells (APCs) express the same MHC haplotype as the host from which the T-cells were derived (Milestone 5.1). This *haplotype restriction* on T-cell recognition tells us unequivocally that MHC molecules are intimately and necessarily involved in the interaction of the antigen-bearing cell with its corresponding antigen-specific T-lymphocyte. We also learn that, generally, cytotoxic T-cells recognize antigen in the context of class I MHC, and helper T-cells interact when the antigen is associated with class II molecules. Accepting, then, the participation of MHC in T-cell recognition, what about the antigen?



Milestone 5.1 MHC restriction of T-cell reactivity

MHC was known to be a dominant controlling element in tissue graft rejection, but could this really be its main function?

A dramatic Nobel prize-winning revelation by Peter Doherty and Rolf Zinkernagel was that cytotoxic T-cells taken from an individual recovering from a viral infection would only kill virally infected cells that share an MHC haplotype with the host. They found that cytotoxic T-cells from mice of the H-2^d haplotype infected with lymphocytic choriomeningitis virus could kill virally infected cells derived from any H-2^d strain but not cells of H-2^k or other H-2 haplotypes. The reciprocal experiment with H-2^k mice shows that this is not just a special property associated with H-2^d (Figure M5.1.1a). Studies with recombinant strains (see Table 4.4) pin-pointed class I MHC as the restricting element and this was confirmed by showing that antibodies to class I MHC block the killing reaction.

The same phenomenon has been repeatedly observed in the human. HLA-A2 individuals recovering from influenza have cytotoxic T-cells that kill HLA-A2 target cells infected with influenza virus, but not cells of a different HLA-A tissue-type specificity (Figure M5.1.1b). Note how cytotoxicity could be inhibited by antiserum specific for the donor HLA-A type, but not by antisera to the allelic form HLA-A1 or the HLA-DR class II framework. Of striking significance is the inability of antibodies to the nucleoprotein to block T-cell recognition even though the T-cell specificity in these studies was known to be directed towards this antigen. As the antibodies react with nucleoprotein in its native form, the conformation of the antigen as presented to the T-cell must be quite different.

In parallel, an entirely comparable series of experiments has established the role of MHC class II molecules in antigen presentation to helper T-cells. Initially, it was shown by Ethan Shevach and Alan Rosenthal that lymphocyte proliferation to antigen *in vitro* could be blocked by antisera raised between two strains of guinea-pig that would have included antibodies to the MHC of the responding lymphocytes. More stringent evidence comes from the type of experiment in which a T-cell clone proliferating in response to ovalbumin on antigen-presenting cells with the H-2A^b phenotype fails to respond if antigen is presented in the context of H-2A^k. However, if the H-2A^k antigen-presenting cells are transfected with the genes encoding H-2A^b, they now communicate effectively with the T-cells (Figure M5.1.2).

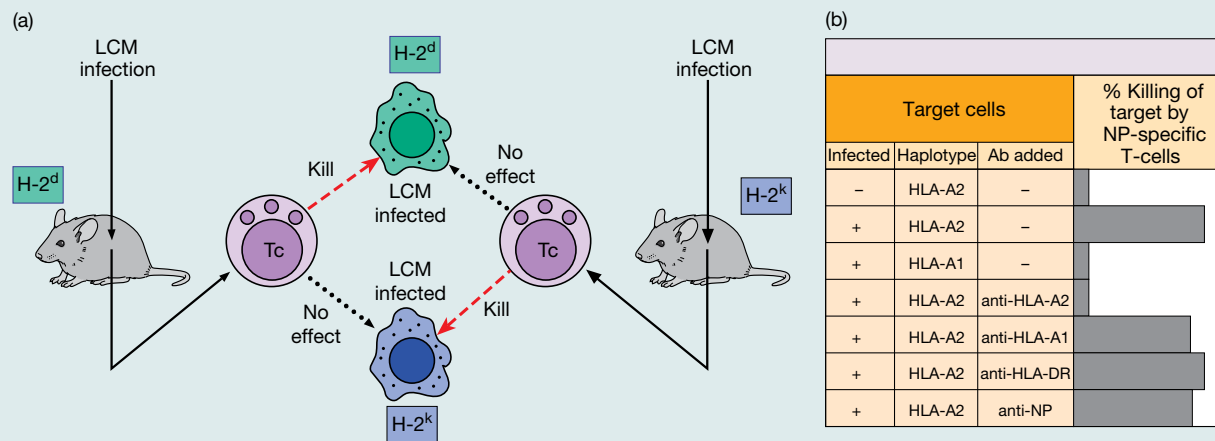


Figure M5.1.1 T-cell killing is restricted by the MHC haplotype of the virus-infected target cells. (a) Haplotype-restricted killing of lymphocytic choriomeningitis (LCM) virus-infected target cells by cytotoxic T-cells. Killer cells from H-2^d hosts only killed H-2^d-infected targets, not those of H-2^k haplotype and vice versa. (b) Killing of influenza-infected target cells by influenza nucleoprotein (NP)-specific T-cells from an HLA-A2 donor. Killing was restricted to HLA-A2 targets and only inhibited by antibodies to A2, not to A1, nor to the class II HLA-DR framework or native NP antigen.

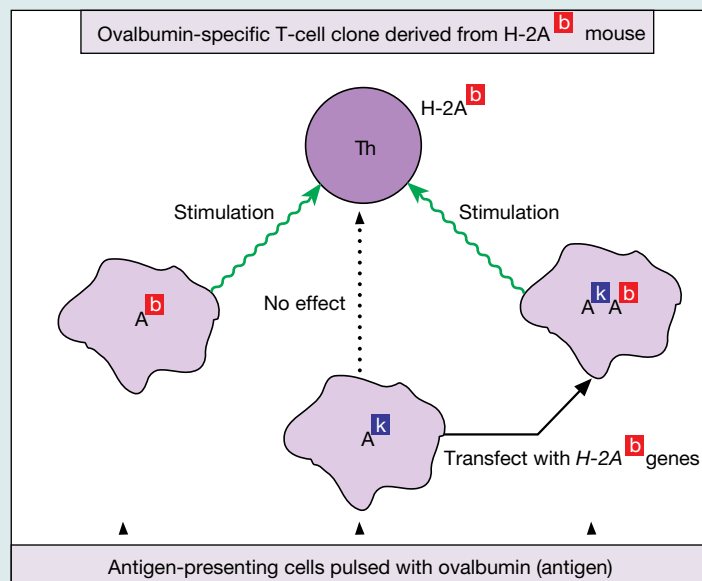


Figure M5.1.2 The T-cell clone only responds by proliferation *in vitro* when the antigen-presenting cells (e.g., macrophages) pulsed with ovalbumin express the same class II MHC.

T-cells recognize a linear peptide sequence from the antigen

In Milestone 5.1, we commented on experiments involving influenza nucleoprotein-specific T-cells that could kill cells infected with influenza virus. Killing occurs after the **cytotoxic T-cell** adheres strongly to its target through recognition of specific cell surface molecules. It is curious then that the nucleoprotein, which lacks a signal sequence or transmembrane region and so cannot be expressed on the cell surface, can nonetheless function as a target for cytotoxic T-cells, particularly as we have already noted that antibodies to native nucleoprotein have no influence on the killing reaction (see Figure M5.1.1b). Furthermore, **uninfected** cells do not become targets for the cytotoxic T-cells when whole nucleoprotein is added to the culture system. However if instead we add a series of short peptides with sequences derived from the primary structure of the nucleoprotein, the uninfected cells now become susceptible to cytotoxic T-cell attack (Figure 5.13).

Thus was the mystery of T-cell recognition of antigen revealed. T-cells recognize linear peptides derived from protein antigens, and that is why antibodies raised against nucleoprotein in its native three-dimensional conformation do not

inhibit killing. Note that only certain nucleoprotein peptides were recognized by the polyclonal T-cells in the donor population and these peptides therefore constitute the **T-cell epitopes**. When clones are derived from these T-cells, each clone reacts with only one of the peptides; in other words, like B-cell clones, each clone is specific for one corresponding epitope.

Entirely analogous results are obtained when **T-helper** clones are stimulated by antigen-presenting cells to which certain peptides derived from the original antigen have been added. Again, by synthesizing a series of such peptides, the T-cell epitope can be mapped with some precision.

The conclusion is that the **T-cell recognizes both MHC and peptide** and we now know that the peptide lies along the groove formed by the α -helices and the β -sheet floor of the class I and class II outermost domains (see Figure 4.19). Just how are the peptides produced? The answer lies in a step referred to as **antigen processing** in which the proteases that are present within cells, either assembled into a structure called the **proteasome** that is present in the cytosol (Figure 5.14a) or located in **endosomal vesicles** (Figure 5.14b), break down intact protein into peptides. Various molecules are then involved in inserting the peptides into the binding groove of the MHC molecule prior to **antigen presentation** of the peptide to the TCR on T-cells. Let's now look in a little more detail at antigen processing.

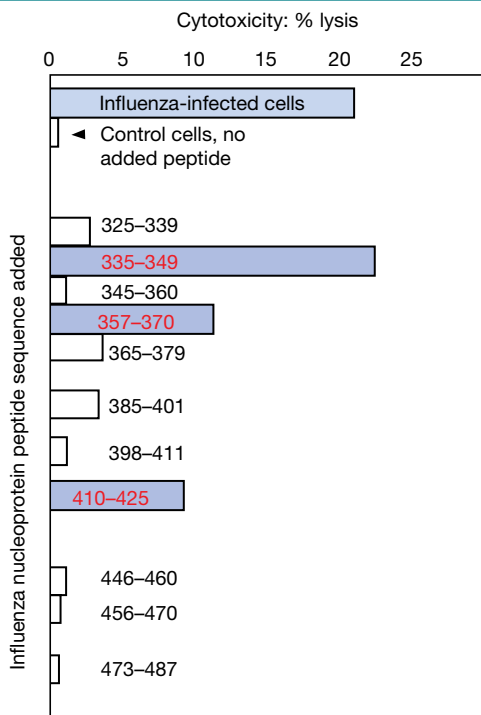


Figure 5.13 Cytotoxic T-cells, from a human donor, kill uninfected target cells in the presence of short influenza nucleoprotein peptides. The peptides indicated were added to ^{51}Cr -labeled syngeneic (i.e., same as T-cell donor) cells and cytotoxicity was assessed by ^{51}Cr release with a killer to target ratio of 50 : 1. The three peptides indicated in red induced good killing. (Source: Townsend A.R.M. *et al.* (1986) *Cell* **44**, 959–968. Reproduced with permission of Elsevier.)

Processing of intracellular antigen for presentation by class I MHC

Proteasomes are constitutively involved in the routine turnover and cellular degradation of proteins. Cytosolic proteins destined for antigen presentation, including viral proteins, are degraded to peptides via the pathway involving these structures. In addition to proteins that are already present in the cytosol, misfolded and misassembled proteins are transported from the ER back into the cytosol by a quality-control process referred to as ER-associated protein degradation (ERAD). Proteins that have undergone retrotranslocation from the ER into the cytosol can then also be processed for class I presentation, as can proteins derived from mitochondria. Prior to processing, polypeptide antigens are covalently linked to several molecules of the 7.5 kDa protein ubiquitin in an ATP-dependent process. This **polyubiquitination** targets the polypeptides to the proteasome (Figure 5.15).

Only a small minority of the peptides produced by the **housekeeping proteasome** are the optimal length (8–10 amino acids) to fit into the MHC class I groove; the remainder are either too short or too long. Longer peptides can be subjected to additional processing by, for example, **cytosolic aminopeptidases** (such as leucine aminopeptidase). Processing can also occur following transfer into the ER; in humans using the endoplasmic reticulum resident aminopeptidases (**ERAP-1 and ERAP-2**), and in mice the ER aminopeptidase associated with antigen processing (**ERAAP**). If the peptides are only slightly too long they can still bind to

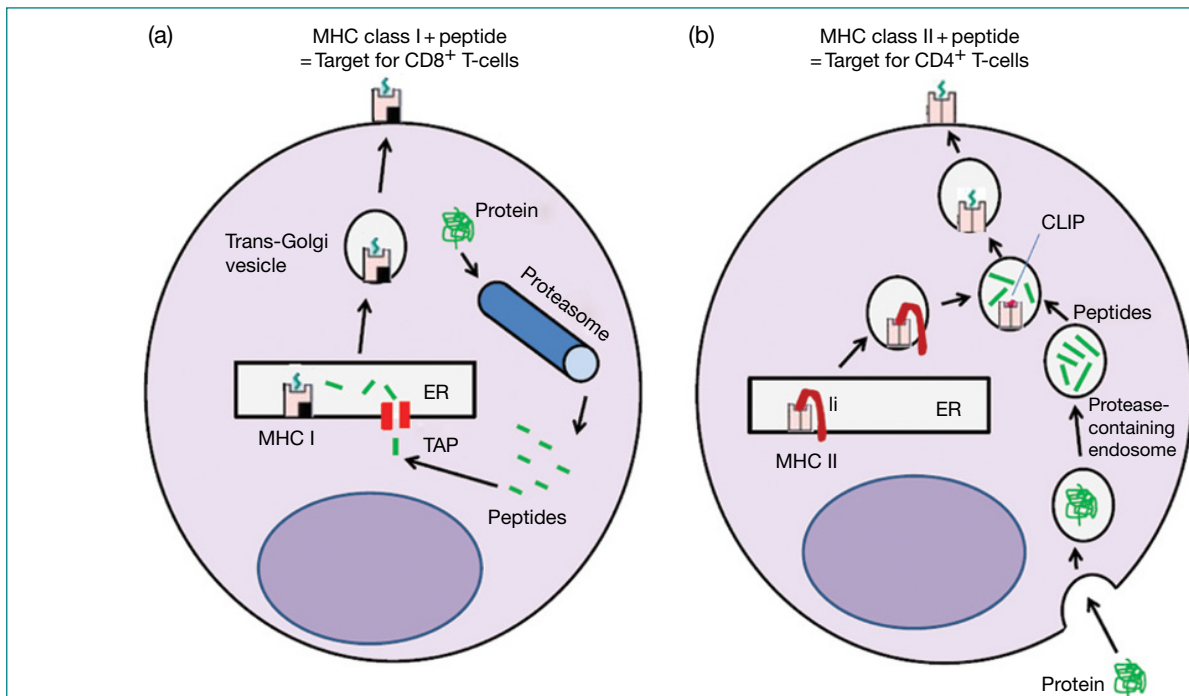


Figure 5.14 Antigen processing and presentation. In order to be recognized by T-cells bearing an $\alpha\beta$ receptor, protein antigen (polypeptide) must be broken down (processed) into short peptides by proteolytic enzymes. (a) Antigens (e.g., viral proteins) present within the cytoplasm of a cell are referred to as endogenous antigen and are processed by enzymes that are organized into a structure called the proteasome. The resulting peptides are then moved from the cytoplasm into the ER through the transporters associated with antigen processing (TAP), and subsequently loaded into a newly synthesized MHC class I molecule. (b) In contrast, antigens taken up by endocytosis or phagocytosis from outside of the cell are described as being exogenous antigen and are degraded into peptides by a different set of proteases that are present in the endocytic/phagocytic vacuoles. The newly synthesized MHC class II molecules need to be transported out of the ER in vesicles that subsequently fuse with the peptide-containing vacuoles. In order to prevent peptides present in the ER binding to the MHC class II molecules (rather than to the intended class I) a “molecular stopper” called invariant chain (Ii) is put into the class II groove. The Ii is later degraded into a fragment called CLIP which is then subsequently exchanged for the peptide. MHC class I and II molecules containing peptides are ultimately taken to the cell surface for antigen presentation to the TCR. MHC class I presents peptides to CD8⁺ T-cells whereas MHC class II presents peptides to CD4⁺ T-cells.

the groove and be recognized by TCRs but in this case, which may apply to up to 10% of class I-bound peptides, they bulge out from the groove.

The cytokine IFN γ increases the production of three specialized catalytic proteasomal subunits, β_1i , β_2i , and β_5i , which replace the homologous catalytic subunits in the housekeeping proteasome to produce the *immunoproteasome*, a structure with modified cleavage specificity that greatly increases the proportion of **8–10 amino acid** long peptides generated. Both proteasome- and immunoproteasome-generated peptides are translocated into the ER by the heterodimeric transporter associated with antigen processing (made up of TAP1 and TAP2 subunits) (Figure 5.15). The newly synthesized class I α chain is retained in the ER by the lectin-like chaperone *calnexin*, which binds to the monoglucosylated *N*-linked glycan of the nascent α chain. Calnexin assists in protein folding and promotes assembly with β_2 -microglobulin. The calnexin is then replaced with *calreticulin*, which has similar lectin-like properties and, together with *TAP1/2*, *tapasin*, and *ERp57* (57 kDa

ER thiol oxidoreductase), constitutes the *peptide loading complex (PLC)*. The *tapasin* bridge ensures that the empty class I molecule sits adjacent to the TAP pores in the ER, thereby facilitating the loading of peptides. Tapasin also plays a peptide-editing role, ensuring preferential incorporation of peptides with high-affinity binding to the MHC class I molecules. Upon peptide loading, the class I molecule dissociates from the PLC, and the now stable MHC–peptide traverses the Golgi stack and reaches the surface where it is a sitting target for the cytotoxic T-cell.

Processing of extracellular antigen for class II MHC presentation follows a different pathway

Class II MHC complexes with antigenic peptide are generated by a fundamentally different intracellular mechanism, as the APCs that interact with T-helper cells need to sample the antigen from the *extracellular* compartment. In essence, a

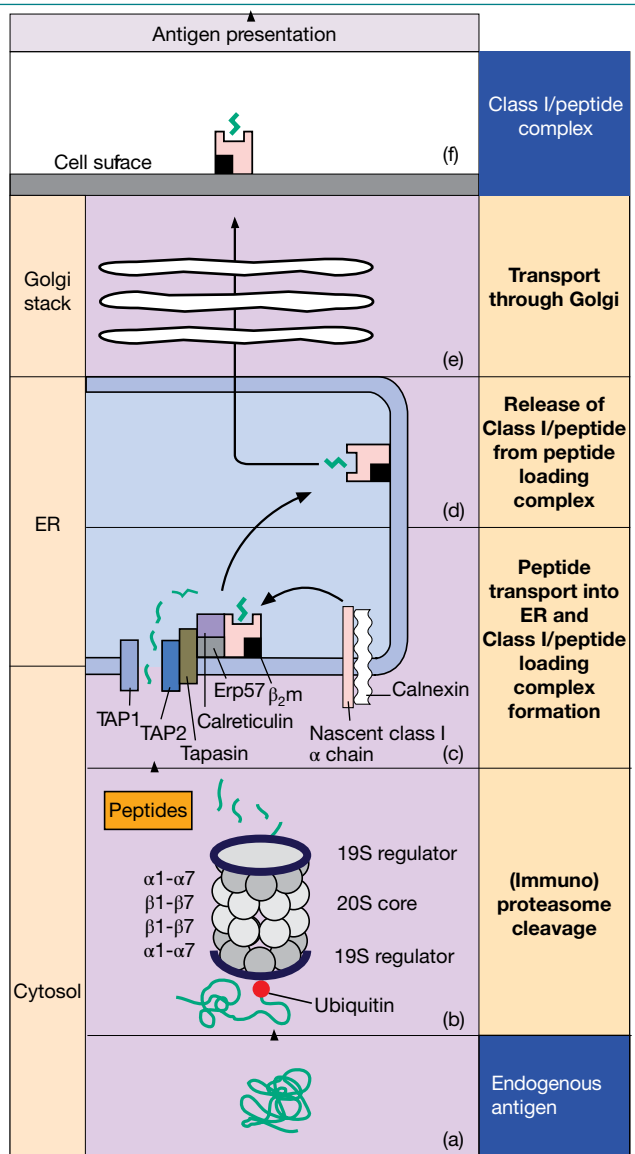


Figure 5.15 Processing of endogenous antigen and presentation by class I MHC. Cytosolic proteins (a) targeted for degradation become polyubiquitinated by the addition of several molecules of ubiquitin. The ubiquitinated protein binds to the 19S regulator of the proteasome (b) which in an ATP-dependent reaction removes the ubiquitin, unfolds the protein, and pushes it into the cylindrical structure of the 20S core proteasome that is made up of 28 subunits arranged in four stacked rings. The resulting peptides are transported into the endoplasmic reticulum (ER) by TAP1 and TAP2 (c). Under the influence of the peptide loading complex (PLC; which comprises TAP1/2 together with calreticulin, tapasin, and ERp57) the peptides are loaded into the groove of the membrane-bound class I MHC. ERp57 isomerizes disulfide bonds to ensure the correct conformation of the class I molecule. Tapasin forms a bridge between TAP1/2 and the other PLC components and is covalently linked to ERp57, which in turn is noncovalently bound to the calreticulin. Following peptide loading the peptide–MHC complex is released from the PLC (d), traverses the Golgi system (e), and appears on the cell surface (f) ready for presentation to the T-cell receptor. Mutant cells deficient in TAP1/2 do not deliver peptides to class I and cannot function as cytotoxic T-cell targets.

trans-Golgi vesicle containing MHC class II has to meet up with a late endosome containing exogenous protein antigen taken into the cell by phagocytosis, macropinocytosis, or endocytosis.

Regarding the class II molecules themselves, these are assembled from α and β chains in the ER in association with the transmembrane *invariant chain (Ii)* (Figure 5.16), which trimerizes to recruit three MHC class II molecules into a nonameric complex. Ii has several functions. First, it acts as a dedicated *chaperone* to ensure correct folding of the nascent class II molecule. Second, an internal sequence of the luminal portion of Ii sits in the MHC groove to inhibit the precocious binding of peptides in the ER before the class II molecule reaches the endocytic compartment containing antigen. Additionally, combination of Ii with the $\alpha\beta$ class II heterodimer *inactivates a retention signal* and allows transport to the Golgi. Finally, *targeting motifs* in the N-terminal cytoplasmic region of Ii ensure delivery of the class II-containing vesicle to the endocytic pathway.

Meanwhile, exogenous protein is taken up by one of the endocytic processes referred to above. The enzyme *GILT* (interferon- γ -induced lysosomal thiol reductase) is present in the endosomes and will break any disulfide bonds that are present in the engulfed proteins. As the early endosome undergoes progressive acidification, the proteins are processed into peptides by a range of proteolytic enzymes (see Figure 5.16 legend). The early endosomes mature into late endosomes and lysosomes, both of which characteristically acquire *lysosomal-associated membrane proteins (LAMPs)*, including the LAMP-2a receptor for chaperone-mediated autophagy. These late endosomes fuse with the vacuole containing the class II–Ii complex. Under the acidic conditions within these MHC class II-enriched compartments (MIICs), asparagine endopeptidase (AEP) and cathepsins S, L, and F degrade Ii except for the part sitting in the MHC groove that, for the time being, remains there as a peptide referred to as CLIP (class II-associated invariant chain peptide). An MHC-related heterodimeric molecule, DM, then catalyzes the removal of CLIP and keeps the groove open so that peptides generated in the endosome can be inserted (Figure 5.17). Initial peptide binding is determined by the concentration of the peptide and its on-rate, but DM subsequently assists in the removal of lower affinity peptides to allow their replacement by high-affinity peptides (i.e., acts as a peptide editor permitting the incorporation of peptides with the most stable binding characteristics, namely those with a slow off-rate). Particularly in B-cells and thymic epithelium, an additional MHC-related heterodimeric molecule, DO, associates with DM bound to class II and inhibits its function. The precise role of DO remains elusive. However, in B-cells it may transiently restrain DM in order to favor the presentation of antigens internalized via the BCR over those taken up by fluid phase endocytosis. The class II–peptide complexes are then transported to the membrane for presentation to T-helper cells.

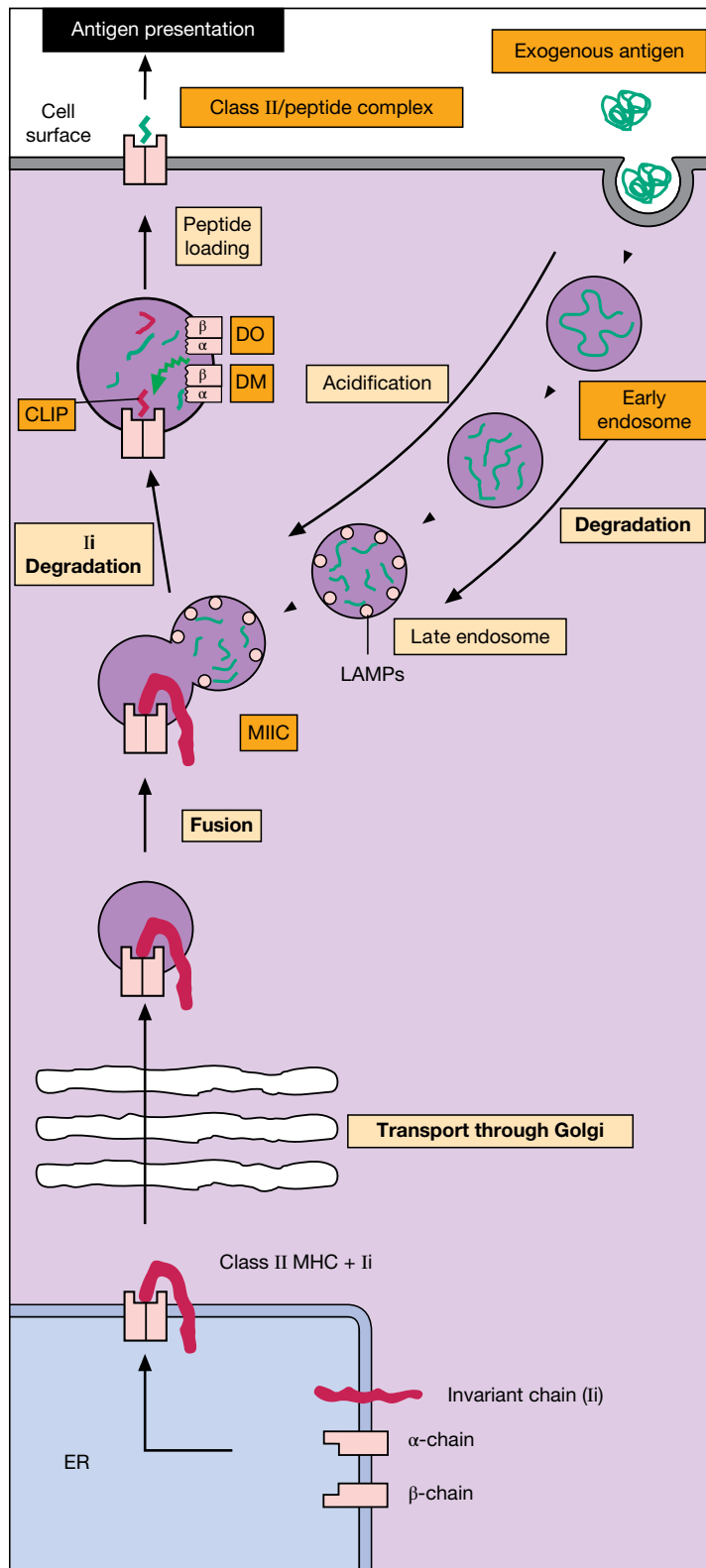


Figure 5.16 Processing of exogenous antigen and presentation by class II MHC. Class II molecules with Ii are assembled (actually as a nonamer consisting of three invariant, three class II α , and three class II β chains – not shown) in the endoplasmic reticulum (ER). They are then transported through the Golgi to the trans-Golgi reticulum. The class II-containing vacuole now fuses with a late endosome which has lysosomal characteristics and contains peptides generated by partial degradation of proteins derived from the endocytic uptake of exogenous antigen. This fusion generates a so-called MHC class II-enriched compartment, MIIC. Particularly implicated in the processing of exogenous antigen in the endosomes are the cysteine proteases cathepsin S and L, both of which have endopeptidase activity, as do both cathepsin D and asparagine endopeptidase (AEP) which might also partake in this process. Subsequently, the exopeptidases cathepsin B and X are thought to trim the C-terminus, and cathepsins C and H to trim the N-terminus of the peptides either prior to or after their binding into the MHC class II groove. Degradation of the invariant chain leaves the CLIP (class II-associated invariant chain peptide) lying in the groove but, under the influence of the DM molecule, this is replaced by the peptides derived from exogenous antigen, and the complexes are transported to the cell surface for presentation to T-helper cells.

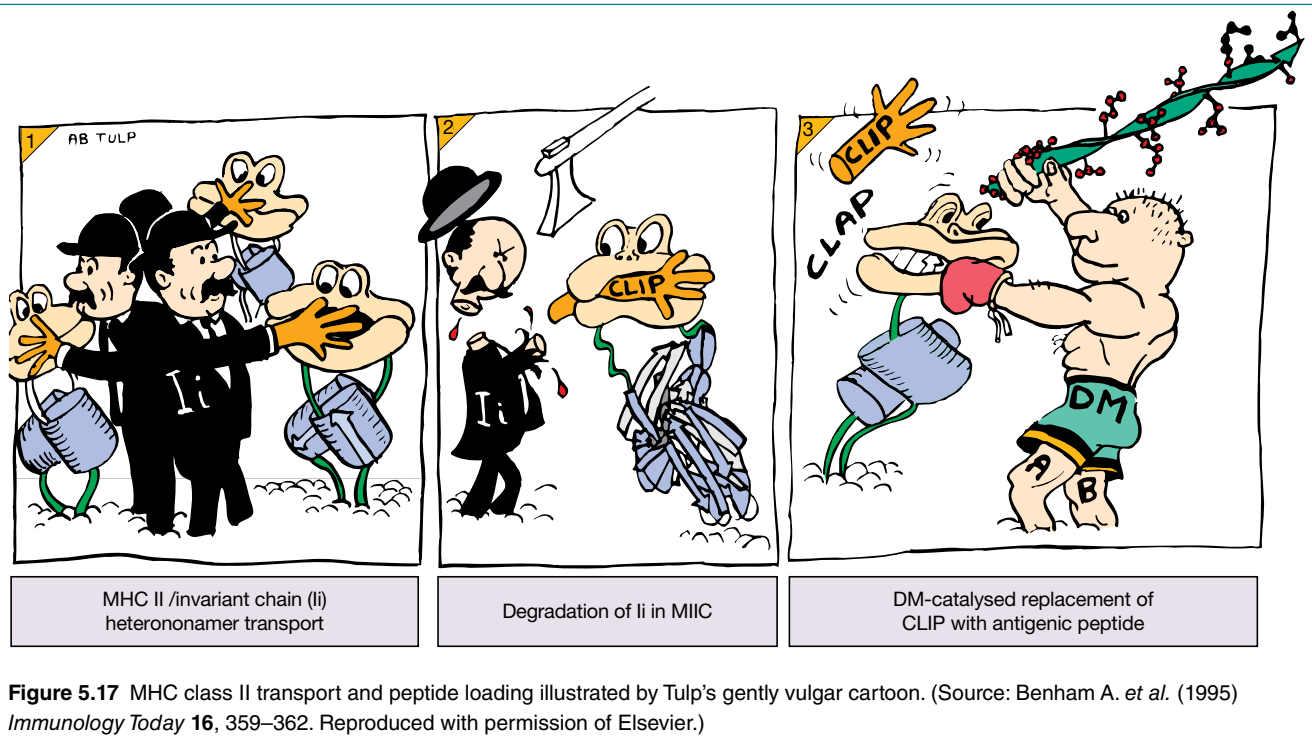


Figure 5.17 MHC class II transport and peptide loading illustrated by Tulp's gently vulgar cartoon. (Source: Benham A. *et al.* (1995) *Immunology Today* 16, 359–362. Reproduced with permission of Elsevier.)

Cross-presentation of antigens

We have just seen how MHC class I presents endogenous antigen while MHC class II presents exogenous antigen. However, between 10–30% of class I molecules present antigen of exogenous origin and a similar proportion of MHC class II molecules present peptides derived from either cytoplasmic or nuclear antigens. Indeed, naive cytotoxic T-cells require dendritic cells for their activation but most viruses are not tropic for dendritic cells and therefore not naturally present in the cytosol of the professional APCs. Given the two separate pathways (endogenous/class I, exogenous/class II) outlined in the previous sections, how can this be achieved? The answer to this conundrum lies in the phenomenon of cross-presentation. Phagocytosed or endocytosed antigens can sneak out through channels in the vacuole into which they have been engulfed and thereby gain entry to the cytosol (Figure 5.18a). Once they enter the cytosol they are fair game for ubiquitination and subsequent degradation by the proteasome, followed by TAP-mediated transfer into the ER, and presentation by MHC class I. It is also possible that some endocytosed antigens can be processed into peptides that are short enough to be loaded directly into recycling MHC class I molecules within the endosome without the need to be first processed in the cytosol. In addition to dendritic cells, macrophages also seem to be able to play the cross-presentation game, albeit less efficiently.

Conversely, some of the proteasome-derived peptides within the cytosol, such as those derived from viral capsids, are of sufficient length to make them potential clients for the class II groove and could make the journey to the MIIC. This can occur by a process known as autophagy, in which portions of

cytoplasm, which can contain peptides generated from the proteasome as well as intact proteins, are engulfed internally by structures referred to as autophagosomes (Figure 5.18b). Autophagy occurs constitutively in professional APCs and the peptide-containing autophagosome can then fuse with the MHC class II-containing MIIC, where proteolytic cleavage of any intact proteins could also take place. From then on events parallel those described for the presentation of exogenous antigens, with the peptides exchanging with CLIP, and transfer of peptide–MHC to the cell surface. During periods of cell stress a second pathway, chaperone-mediated autophagy, can be employed involving members of the heat-shock protein 70 (*hsp70*) family that bind to the protein to be processed. The protein complex is then recognized by LAMP-2a and dragged into the lumen of a lysosome for subsequent processing.

The nature of the “groovy” peptide

The MHC groove, which binds a single peptide, imposes some well-defined restrictions on the nature and length of the peptide that it can accommodate. However, at the majority of positions in the peptide ligand, a surprising degree of redundancy is permitted and this relates in part to residues interacting with the T-cell receptor rather than the MHC. Thus, each MHC molecule has the potential to bind hundreds or even thousands of different peptide sequences so long as at certain amino acid positions the peptides share characteristic conserved anchor residues for that particular MHC allele. Different MHC alleles will bind a different range of peptides thanks to the difference in sequence of the binding groove of the different MHC variants.

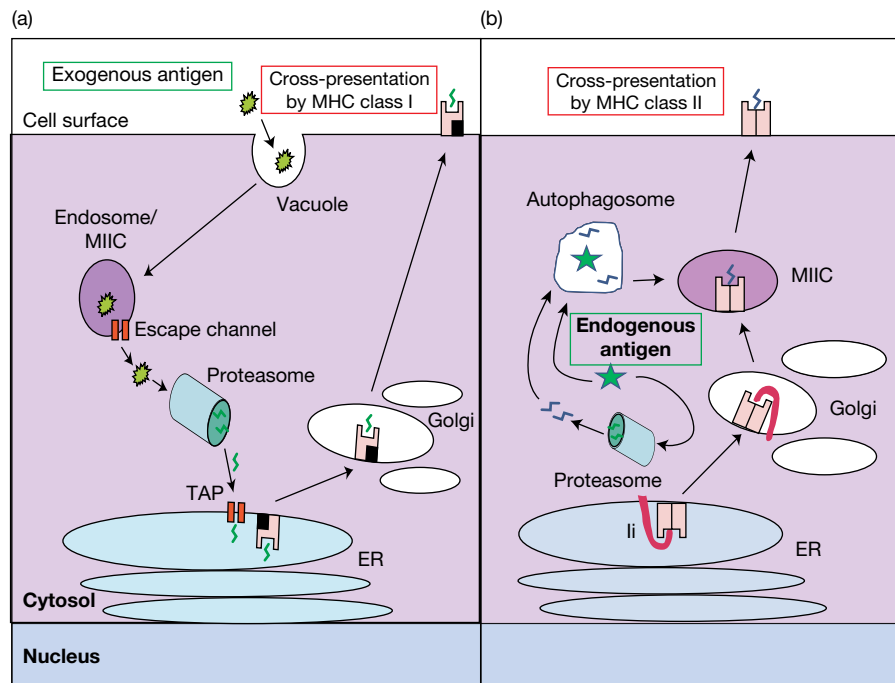


Figure 5.18 Cross-presentation of antigen. (a) Engulfed exogenous antigens are able to access the class I processing pathway by exiting the late endosomes and the MHC class II compartments (MIIC) through escape channels. Other routes for the presentation by MHC class I of peptides derived from exogenous antigens may include peptide exchange with MHC class I molecules recycling from the cell membrane. (b) Cross-presentation can also work the other way round with cytosolic peptides generated from the proteasome (and also intact endogenous antigens) undergoing autophagy to gain entry into the class II processing and presentation pathway. ER, endoplasmic reticulum; TAP, transporter associated with antigen processing.

Binding to MHC class I

X-ray crystallographic analysis reveals the peptides to be tightly mounted along the length of the groove in an extended configuration with no breathing space for α -helical structures (Figure 5.19). The molecular forces involved in peptide binding to MHC and in TCR binding to peptide–MHC are similar to those seen between antibody and antigen (i.e., noncovalent).

The naturally occurring peptides can be extracted from purified MHC class I and sequenced. They are predominantly **8–10 residues** long; because the MHC class I peptide-binding groove is closed at both ends, any peptides that are slightly longer than this have to bulge upwards out of the cleft. Analysis of the peptide pool sequences indicates amino acids with defined characteristics at certain key positions (Table 5.1). These are called **anchor positions** and represent the amino acid side-chains required to fit into **allele-specific pockets** in the MHC groove (Figure 5.20a). There are usually **two**, sometimes **three**, such major anchor positions for class I-binding peptides, frequently at peptide positions 2 (P2) and 9 (P9) but sometimes at other positions. For example, the highly prevalent HLA-A*0201 has a pocket that will accept leucine, methionine, or isoleucine at peptide position P2 and a pocket that will accept leucine, valine, isoleucine, or methionine at P9

(Table 5.1). In some HLA alleles, instead of a major anchor pocket there are two or three more weakly binding pockets. Even with the constraints of two or three anchor motifs, each MHC class I allele can accommodate hundreds or even thousands of different peptides. Thus, so long as the criteria for the anchor positions are met, the other amino acids in the sequence can vary. **Allele-independent** hydrogen-bonding to conserved residues at either end of the MHC class I groove occurs at the N- and C-termini of the peptide.

Except in the case of infection, the natural class I ligands will be self peptides derived from proteins endogenously synthesized by the cell, histones, heat-shock proteins, enzymes, leader signal sequences, and so on. About 75% of these peptides originate in the cytosol and most of them will be in low abundance, say 100–400 copies per cell. Thus proteins expressed with unusual abundance, such as oncofetal proteins in tumors and viral antigens in infected cells, should be readily detected by resting T-cells.

Binding to MHC class II

Unlike class I, the class II groove is open at both ends and therefore can bind longer peptides, typically about **15–20 amino acids** long. However, just as for class I, it is a stretch of about 9 amino acids that are directly involved in the

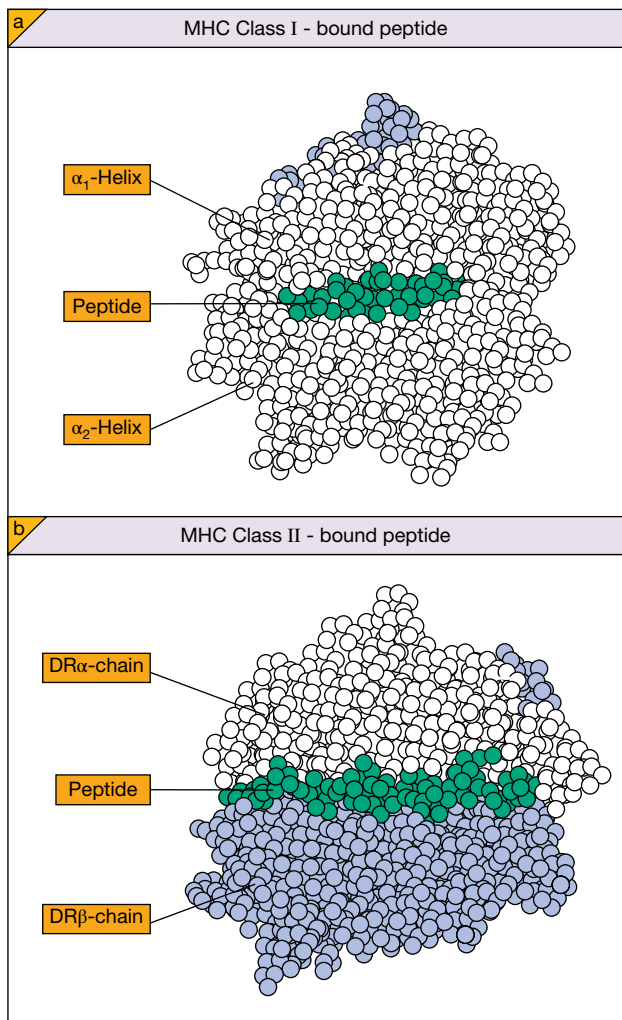


Figure 5.19 Binding of peptides to the MHC cleft. T-cell receptor (TCR) “view” looking down on the α -helices lining the cleft (see Figure 4.19b) represented in space-filling models. (a) Peptide 309–317 from HIV-1 reverse transcriptase bound tightly within the class I HLA-A2 cleft. In general, one to four of the peptide side-chains points towards the TCR, giving a solvent accessibility of 17–27%. (b) Influenza hemagglutinin 306–318 lying in the class II HLA-DR1 cleft. In contrast with class I, the peptide extends out of both ends of the binding groove and from four to six side-chains point towards the TCR, increasing solvent accessibility to 35%. (Adapted from Vignali D.A.A. and Strominger J.L. (1994) *The Immunologist* 2, 112. Reproduced with permission of Hogrefe & Huber Publishers.)

interaction and this portion is referred to as the peptide binding register. The other amino acids can extend from each end of the groove, quite unlike the strait-jacket of the class I ligand site (Figure 5.19 and Figure 5.20), and are susceptible to proteolytic trimming. With respect to class II allele-specific binding pockets for peptide side-chains, the motifs are based on three or four major anchor residues, typically but not invariably at P1, P4, P6, and P9 (Figure 5.20b).

Unfortunately, it is difficult to establish these preferences for the individual residues within a given peptide. This is because although the length of the class II groove is similar to that of class I, the open nature of the groove in class II places no constraint on the length of the ligand. Thus, each class II molecule binds a collection of peptides of varying length, and analysis of such a naturally occurring pool isolated from the MHC would not establish which amino acid side-chains were binding preferentially to the nine available sites within the groove. One approach to get around this problem is to study the binding of soluble class II molecules to very large libraries of random-sequence nonapeptides expressed on the surface of bacteriophages.

Peptide binding leads to a transition from a more open conformation to one with a more compact structure extending throughout the peptide-binding groove. The range of concentrations of the different peptide complexes that result will engender a hierarchy of dominance of epitopes with respect to their ability to interact with T-cells.

The $\alpha\beta$ T-cell receptor binds to a combination of MHC and peptide

When soluble TCR preparations produced using recombinant DNA technology are immobilized on a sensor chip, they can bind MHC–peptide complex specifically with rather low affinities (K_d) in the 10^4 – 10^7 M^{-1} range. This low affinity and the relatively small number of atomic contacts formed between the TCRs and their MHC–peptide ligands when T-cells contact their target cell make the contribution of TCR recognition to the binding energy of this cellular interaction fairly trivial. The brunt of the attraction rests on the antigen-independent major adhesion molecule pairs, such as LFA-1–ICAM-1 and CD2–LFA-3 that are recruited into the immunological synapse (see Figure 7.20), but any subsequent triggering of the T-cell by MHC–peptide antigen must involve signaling through the T-cell receptor.

Topology of the ternary complex

Of the three complementarity determining regions present in each TCR chain, CDR1 and CDR2 are much less variable than CDR3. Unlike immunoglobulins, somatic hypermutation does not occur in TCR genes, so variability in CDR1 and CDR2 is limited by the number of germline V genes. However, just like in immunoglobulin, the TCR CDR3 is encoded by a V(D)J sequence that results from combinatorial and nucleotide insertion mechanisms. As the MHC sequences in a given individual are fixed, whereas there will be a large number of different peptide sequences, a logical model would have CDR1 and CDR2 of each TCR chain contacting the α -helices at the tip of the MHC peptide-binding groove, and the much more variable CDR3 contacting the peptide. In accord with this view, several studies have shown that T-cells that recognize small variations in a peptide in the context of a given MHC molecule differ only in their CDR3 regions.

Table 5.1 Natural MHC class I peptide ligands contain two allele-specific anchor residues.

Class I allele	Amino acid position								
	1	2	3	4	5	6	7	8	9
H-2K ^d	•	Y	•	•	•	•	•	•	I/L
H-2K ^b	•	•	•	•	Y/L	•	•	L/M	
H-2D ^b	•	•	•	•	N	•	•	•	L/M/I
HLA-A*0201	•	L/M/I	•	•	•	•	•	•	L/V/I/M
HLA-B*2705	•	R	•	•	•	•	•	•	R/K/L/F

Based on Rammensee H.G. *et al.* (1995) *Immunogenetics* 41, 178.

Letters represent the Dayhoff code for amino acids: F, Phenylalanine; I, Isoleucine; K, Lysine; L, Leucine; M, Methionine; N, Asparagine; R, Arginine; V, Valine; Y, Tyrosine. Where more than one residue predominates at a given position, the alternative(s) is given; • = any residue.

The combining sites of the TCRs are generally relatively flat (Figure 5.21), which would be expected given the need for complementarity to the gently undulating surface of the peptide–MHC combination (Figure 5.22a). In most of the structures so far solved, recognition involves the TCR lying either diagonally (Figure 5.22b) or orthogonally (Figure 5.22c) across the peptide–MHC with the TCR V α CDR1 and CDR2 overlying the MHC class II β_1 -helix or class I α_2 -helix, and the V β CDR1 and CDR2 overlying the α_1 -helix of MHC class I or class II (Figure 5.23). The more variable CDR3 regions make contact with the peptide, particularly focusing in on the middle residues (P4 to P6). There is evidence to suggest that the TCR initially binds to the MHC in a fairly peptide-independent fashion, followed by conformational changes particularly in the peptide-recognizing CDR3 loops of the TCR to permit optimal contact with the peptide. Activation through the TCR-CD3 complex can operate if these adjustments permit more stable and multimeric binding. The CD4 or CD8 co-receptor for MHC binds to nonpolymorphic residues present in the α_2 and β_2 domains of class II (Figure 5.24), and in the α_3 domain of class I, respectively.

MHC class I-like molecules

In addition to the highly polymorphic classical MHC class I molecules (HLA-A, -B, and -C in the human and H-2 K, -D, and -L in the mouse), there are other loci encoding peptide-presenting MHC molecules containing β_2 -microglobulin with relatively nonpolymorphic heavy chains. These are *H-2M3*, *-Qa*, and *-Q* in mice, and *HLA-E*, *-F*, and *-G* in humans. In addition there are a number of specialized MHC homologs, including the T10 and T22 molecules which act as ligands for $\gamma\delta$ T-cells, that do not present peptides and are present in mice but not in humans.

The *H-2M3* molecule is unusual in that its peptide-binding groove has many nonpolar amino acids designed to facilitate the binding of the characteristic hydrophobic *N*-formylmethionine residue of peptides derived from bacterial proteins, which can then be presented to T-cells. Expression of

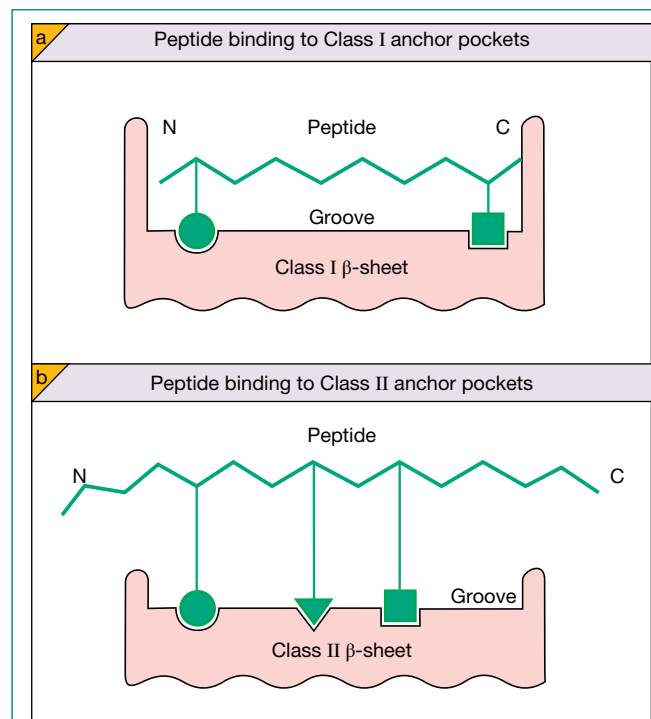


Figure 5.20 Allele-specific pockets in the MHC-binding grooves bind the major anchor residue motifs of the peptide ligands. Cross-section through the longitudinal axis of the MHC groove. The two α -helices forming the lateral walls of the groove lie horizontally above and below the plane of the paper. (a) The class I groove is closed at both ends. The anchor positions are very often at P2 and P9 but may also be at other locations depending on the MHC allele (see Table 5.1). (b) By contrast, the class II groove is open at both ends and does not constrain the length of the peptide. There are usually three or four major anchor pockets with, for example, P1 dominant for HLA-DR1 and P4 dominant for HLA-DR3.

H-2M3 is limited by the availability of these peptides so that high levels are only seen during prokaryotic infections. Discussion of the role of HLA-G expression in the human extravillous cytotrophoblast will arise in Chapter 15.

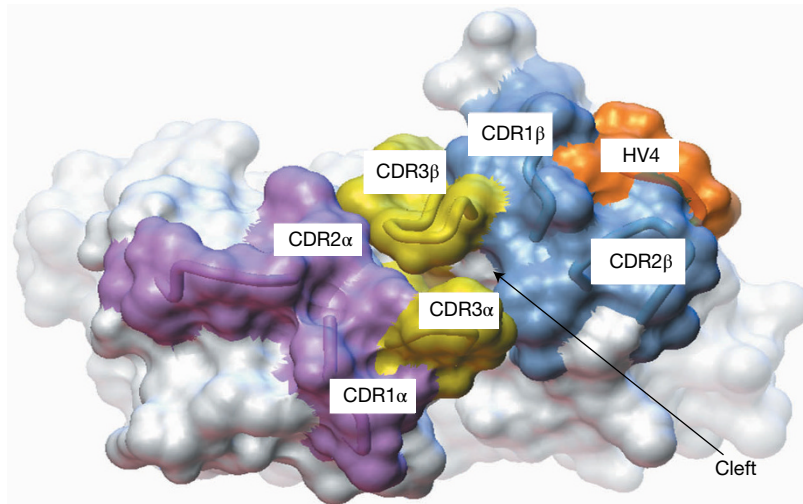


Figure 5.21 T-cell receptor antigen combining site. In this example (a murine TCR called 2C), although the surface is relatively flat, there is a cleft between the CDR3 α and CDR3 β that can accommodate a central upfacing side-chain of the peptide bound into the groove of an MHC molecule. The surface and loop traces of the V α CDR1 and CDR2 are colored magenta, V β CDR1 and CDR2 blue, V α CDR3 and V β CDR3 yellow, and the V β fourth hypervariable region, which makes contact with some superantigens, orange. (Source: Garcia K.C. *et al.* (1996) *Science* **274**, 209–219. Reproduced with permission of AAAS.)

T-cell recognition of non-protein antigens

CD1 presents lipid, glycolipid, and lipoprotein antigens

After MHC class I and class II, the **CD1** family (CD1a–e) of molecules comprise a third set of antigen-presenting molecules recognized by T-lymphocytes. Just like the MHC class I α chain, CD1 associates with β_2 -microglobulin, and the overall structure is indeed similar to that of classical class I molecules, although the topology of the binding groove is altered (see Figure 4.29). CD1 molecules can present (Figure 5.25) a broad range of **lipid**, **glycolipid**, and **lipopeptide** antigens, and even certain small organic molecules, to clonally diverse $\alpha\beta$ and $\gamma\delta$ T-cells and, for CD1d, to NKT cells.

A common structural motif facilitates CD1-mediated antigen presentation and comprises a hydrophobic region of a branched or dual acyl chain and a hydrophilic portion formed by the polar or charged groups of the lipid and/or its associated carbohydrate or peptide. In a solved crystal structure the hydrophobic regions are buried in the deep binding groove of CD1b, while the hydrophilic regions, such as the carbohydrate structures, are recognized by the TCR (Figure 5.26). In another solved structure, the $\alpha\beta$ TCR recognizes CD1d plus α -galactosylceramide by docking in parallel to the complex (Figure 5.27). This is rather different to the diagonal or orthogonal binding usually seen with $\alpha\beta$ TCR recognition of peptide–MHC (Figure 5.28).

Both endogenous and exogenous lipids can be presented by CD1 (Figure 5.25) and, like MHC class I, the CD1 heavy chain complexes initially with calnexin in the endoplasmic

reticulum and is then subsequently replaced with calreticulin. The protein ERp57 is then recruited into the complex. Subsequent dissociation of the complex permits the binding of β_2 -microglobulin and, in a step involving the microsomal triglyceride-transfer protein (MTP), the insertion of endogenous lipid antigens into the CD1 antigen-binding region. Just like their proteinaceous colleagues, exogenously derived lipid and glycolipid antigens are delivered to the acidic endosomal compartment. Both humans and mice deficient in prosaposin, a precursor molecule of the sphingolipid activator proteins (SAPs) saposin A–D, are defective in the presentation of lipid antigens to T-cells. Various lines of enquiry indicate that these molecules are involved in the transfer of lipid antigens to CD1 in the endosomes (Figure 5.25). Ligands for **CD1a** include the sulfatide sphingolipid and mycopeptides such as didehydroxymycobactin from *Mycobacterium tuberculosis*; those for **CD1b** are mycolic acid and carbohydrate structures, such as the mycobacterial cell wall component lipoarabinomannan; and those for **CD1c** include mycobacterial mannosyl-1-phosphodolichol. The α -galactosylceramide from marine sponges is known to be a very potent stimulator of invariant NKT (iNKT) cells when presented by CD1d. Microbial lipids presented by **CD1d** include *Borrelia burgdorferi* α -galactosyl diacylglycerol, whereas endogenous lipids such as lysophosphatidylcholine presented by this member of the CD1 family may act as markers of inflammation. The fifth member of the family, **CD1e**, has very distinct properties and may function rather like saposin as a lipid exchange facilitator for CD1b and CD1c to permit the replacement of endogenous lipid with those of microbial origin.

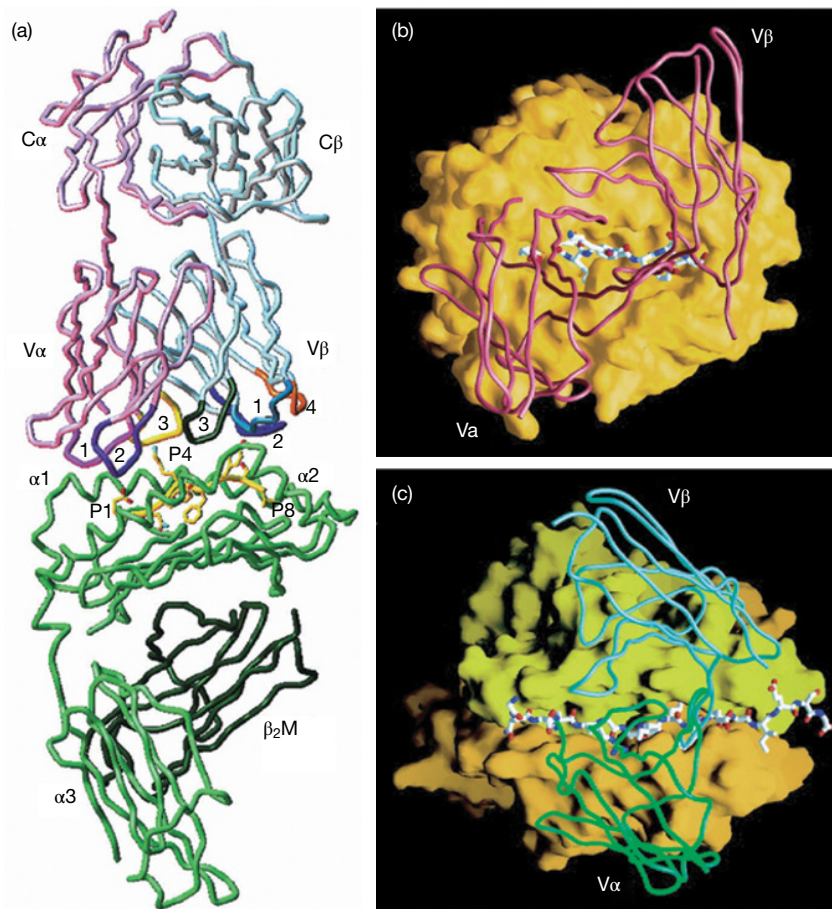


Figure 5.22 Complementarity between MHC–peptide and T-cell receptor. (a) Backbone structure of a TCR (2C) recognizing a peptide (called dEV8) presented by the MHC class I molecule H-2K^b. The TCR is in the top half of the picture, with the α chain in pink and its CDR1 colored magenta, CDR2 purple, and CDR3 yellow. The β chain is colored light blue with its CDR1 cyan, CDR2 navy blue, CDR3 green, and the fourth hypervariable loop orange. Below the TCR is the MHC α chain in green and β_2 -microglobulin in dark green. The peptide with side-chains at positions P1, P4, and P8 is colored yellow. (Source: (a) Garcia K.C. *et al.* (1998) *Science* 279, 1166–1172.). (b) The same complex looking down onto a molecular surface representation of the H-2K^b in yellow, with the diagonal docking mode of the TCR in a backbone worm representation colored pink. The peptide is drawn in a ball and stick format. (c) By contrast, here we see the orthogonal docking mode of a TCR (called D10) recognizing a conalbumin-derived peptide presented by MHC class II. The TCR backbone worm representation shows the V α in green and V β in blue, and the I-A^k class II molecular surface representation has the α chain in light green and the β chain in orange, holding the peptide. (Source: (b,c) Reinherz E.L. *et al.* (1999) *Science* 286, 1913–1921. Reproduced with permission of AAAS.)

NKT cells

NKT cells possess the NK1.1 marker, characteristic of NK cells, together with a T-cell receptor. There are two populations, one with diverse TCRs and the other referred to as invariant NKT-cells (iNKT cells). In the latter population the TCR bears an invariant α chain (V α 24J α 18 in humans, V α 14J α 18 in mice) with no N-region modifications and an extremely limited β chain repertoire based upon V β 11 in the human and V β 8.2, V β 7, and V β 2 in the mouse. They recognize lipid antigens presented by CD1d and constitute a major component of the T-cell compartment, accounting for approximately 30% of the T-cells in the liver (and up to 2.5% of T-cells in the secondary lymphoid tissues) in mice. Although

iNKT cells are present at a much lower frequency in humans, the NKT population with diverse receptors is much more prevalent in humans than in mice. Upon activation, NKT cells rapidly secrete IL-4 and IFN γ and thereby can be involved in the stimulation of many cell types, including dendritic cells, NK cells, and B-cells.

Antigen recognition by $\gamma\delta$ T-cells

Unlike $\alpha\beta$ T-cells, $\gamma\delta$ T-cells recognize antigens directly without a requirement for antigen processing. Human $\gamma\delta$ T-cells have been isolated that directly recognize the MHC-related non-peptide-binding molecules MICA or MICB, or recognize

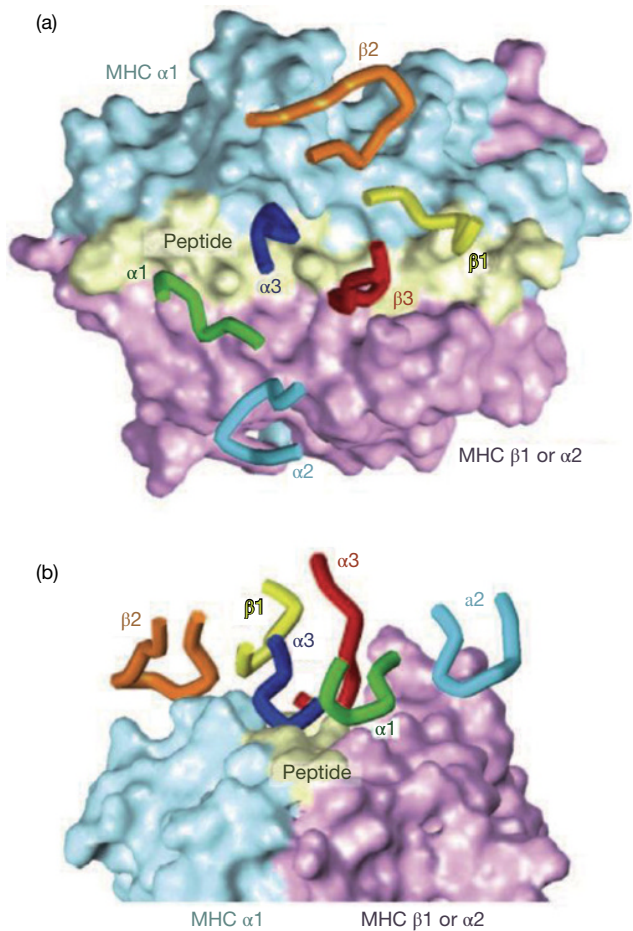


Figure 5.23 TCR CDR3 recognition of peptide presented by MHC. (a) Contacts between the CDR1–3 loops of the α and β chains of a T-cell receptor (TCR) and a space-filling surface of MHC and peptide. The example shown here is a mouse TCR bound to the H2 I-A^b presenting a 13-mer peptide. The $\alpha 1$ region of MHC is colored cyan, the $\beta 1$ or $\alpha 2$ region of MHC magenta and the peptide yellow. The CDR loops of the TCR α and β chains are indicated ($\alpha 1$ is CDR1 of the α chain, and so on). (b) Elevation perspective of the interactions. (Source: Marrack P. *et al.* (2008) *Annual Review of Immunology* **26**, 171–203. Reproduced with permission of Annual Reviews.)

CD1c irrespective of any lipid or glycolipid antigen; and similarly in mice $\gamma\delta$ T-cells are present that recognize the MHC class I molecule I-E^k (irrespective of which peptide is bound) or the MHC-like non-peptide-binding molecules T10 and T22. Other $\gamma\delta$ T-cells can respond to infectious agents such as cytomegalovirus. It would appear that $\gamma\delta$ cells have a distinctive role complementary to that of the $\alpha\beta$ population and function in the direct recognition of microbial pathogens and of damaged or stressed host cells.

Evidence for direct recognition of antigen by $\gamma\delta$ T-cells came from experiments such as those involving a $\gamma\delta$ T-cell clone specific for the herpes simplex virus glycoprotein-1. This clone could be stimulated by the native protein bound to plastic,

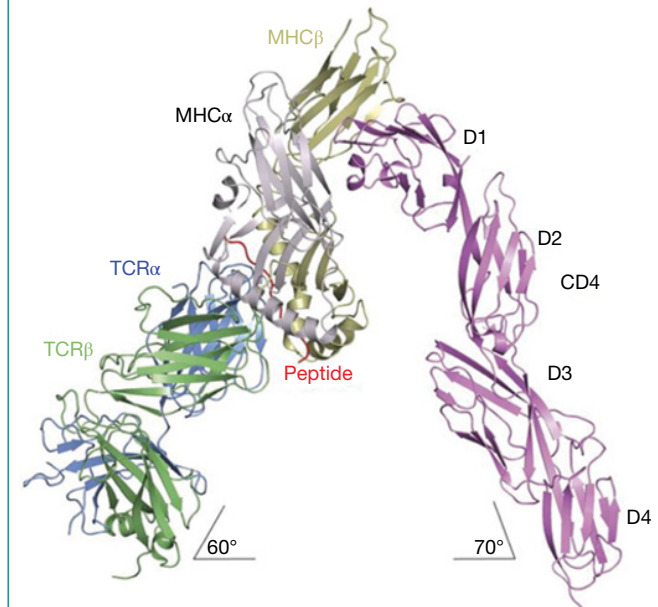


Figure 5.24 The TCR–peptide–MHC–CD4 complex. Ribbon diagram of the complex oriented as if the TCR (MS2–3C8) and CD4 molecules are attached to the T-cell at the bottom and the MHC class II molecule (HLA-DR4) is attached to an opposing APC at the top. TCR α chain, blue; TCR β chain, green; CD4, pink; MHC α chain, gray; MHC β chain, yellow; peptide (derived from myelin basic protein), red. (Source: Yin Y. *et al.* (2012) *Proceedings of the National Academy of Sciences of the USA*. **109**, 5405–5410. Reproduced with permission.)

suggesting that the cells are triggered by cross-linking of their receptors by antigen that they recognize in the intact native state just as antibodies do. There are structural arguments to give weight to this view. Notwithstanding the inclusion of a short D segment in the β chain, the CDR3 loops are comparable in length and relatively constrained with respect to size in the α and β chains of the $\alpha\beta$ TCR, reflecting a relative constancy in the size of the MHC–peptide complexes to which they bind. CDR3 regions in the immunoglobulin light chains are short and similarly constrained in length, but in the heavy chains they are longer and more variable in length, related to their need to recognize a wide range of epitopes. Quite strikingly, the $\gamma\delta$ TCRs resemble antibodies in that the γ chain CDR3 loops are short with a narrow length distribution, while in the δ chain they are relatively long with a broad length distribution. Therefore, in this respect, the **$\gamma\delta$ TCR resembles antibody** more than the $\alpha\beta$ TCR. When the first X-ray crystallographic structure of a mouse $\gamma\delta$ TCR bound to its ligand, the nonclassical MHC molecule T22 mentioned above, was solved it was found to have a rather unusual mode of antigen recognition. The extended CDR3 loop of the δ chain, particularly the D $\delta 2$ segment encoded by a nonmutated (germline) sequence, mediated most of the binding with a minor contribution also made by the CDR3 of the γ chain. However a more recent structure of a

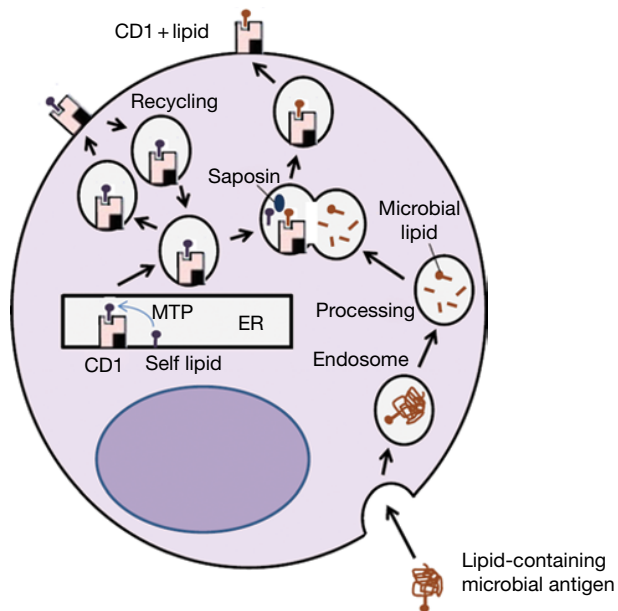


Figure 5.25 The processing and presentation of lipid antigens. The CD1 molecules containing self lipid transit to the cell surface (where they may be able to stimulate self-reactive T-cells). Subsequently the CD1 molecules are internalized into clathrin-coated pits and can be recycled to meet with the endocytic pathway. Some CD1 molecules may also be directly sent to meet up with the endosomes, bypassing a preliminary cell surface step. Newly synthesized CD1 molecules in the endoplasmic reticulum (ER) can incorporate self lipids in a process mediated by the microsomal triglyceride transfer protein (MTP). One route for the presentation of exogenous lipid antigens involves the exchange of self and foreign lipid antigen in endosomal compartments. Lipid-containing pathogen antigens are taken up by the cell, either by receptor-mediated (e.g., by low density lipoprotein receptor, C-type lectin receptors or scavenger receptors) or by general uptake. Enzyme-mediated processing of these foreign antigens can take place in the late endosomes and, following fusion with the trans-Golgi vesicle containing the CD1 and self lipid, saposin-mediated exchange of the foreign and self lipid can occur. The foreign lipid-containing CD1 is then taken to the cell surface for recognition by $\alpha\beta$ T-cells, $\gamma\delta$ T-cells, or NKT cells bearing an appropriate TCR.

human $\gamma\delta$ TCR, in this case binding to MICA, indicated a focus on CDR1 and CDR2 rather than CDR3 of the δ chain. We will need to wait until more structures are solved before the spectrum of binding sites used by $\gamma\delta$ TCRs can be better appreciated.

A particular subset of $\gamma\delta$ cells in humans always use the $V\gamma 9$ and $V\delta 2$ gene segments (despite utilizing different D and J gene segments). This subset can expand *in vivo* to comprise a majority of the circulating $\gamma\delta$ T-cells during a diverse range of infections. These $V\gamma 9V\delta 2$ T-cells have been shown to recognize phospho-antigens, including a number of such antigens produced by several human pathogens including *Mycobacterium tuberculosis* and *Plasmodium malariae*.

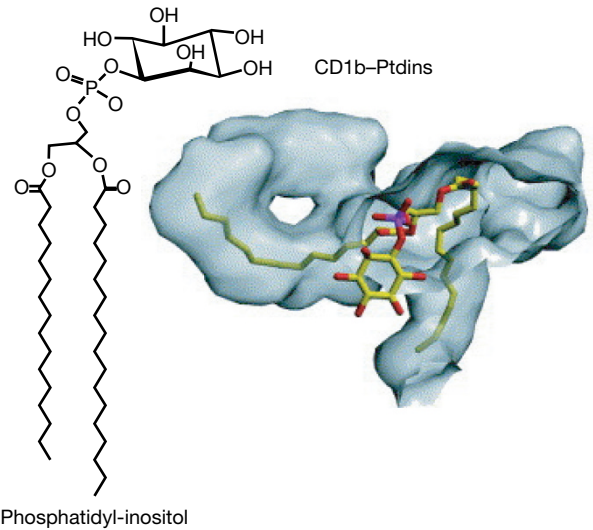


Figure 5.26 The CD1 antigen-binding pocket. In this example the binding of phosphatidylinositol (Ptdins) to CD1b is shown with the binding pocket represented from a top view, looking directly into the groove. Aliphatic backbones are in green, phosphorus atom in blue, and oxygen atoms in red. (Source: Hava D.L. *et al.* (2005) *Current Opinion in Immunology* 17, 88–94. Reproduced with permission of Elsevier.)

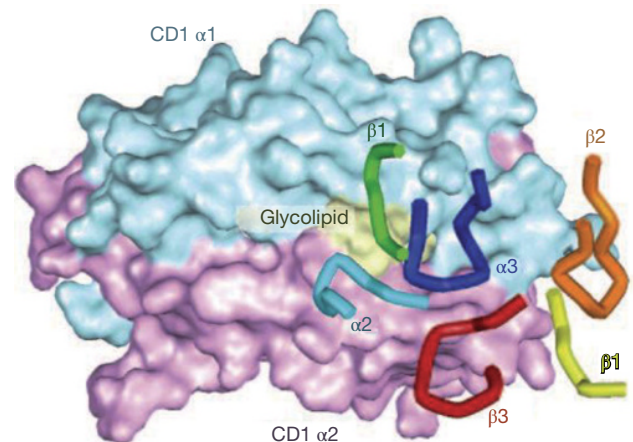


Figure 5.27 T-cell receptor (TCR) recognition of CD1d-presented antigen. $\alpha\beta$ TCR recognition of α -galactosylceramide presented by CD1d. The $\alpha 1$ (colored cyan) and $\alpha 2$ (magenta) regions of CD1d and the glycolipid (yellow) are shown, together with the CDR loops of the TCR α and β chains. Note the TCR binding is towards one end of the CD1d molecule. Because the lipid component of the antigen is buried within the CD1d molecule, recognition of α -galactosylceramide by the TCR involves only the protruding glycosyl head. The TCR α chain CDR1 ($\alpha 1$) interacts only with the antigen, whereas the α chain CDR3 ($\alpha 3$) interacts with both the antigen and CD1d. Recognition of the antigen does not involve the TCR β chain, whose CDR2 ($\beta 2$) and CDR3 ($\beta 3$) bind to CD1d. The α chain CDR2 ($\alpha 2$) and β chain CDR1 ($\beta 1$) are not involved in binding to the CD1d-antigen complex in this example. (Source: Marrack P. *et al.* (2008) *Annual Review of Immunology* 26, 171–203. Reproduced with permission of Annual Reviews.)

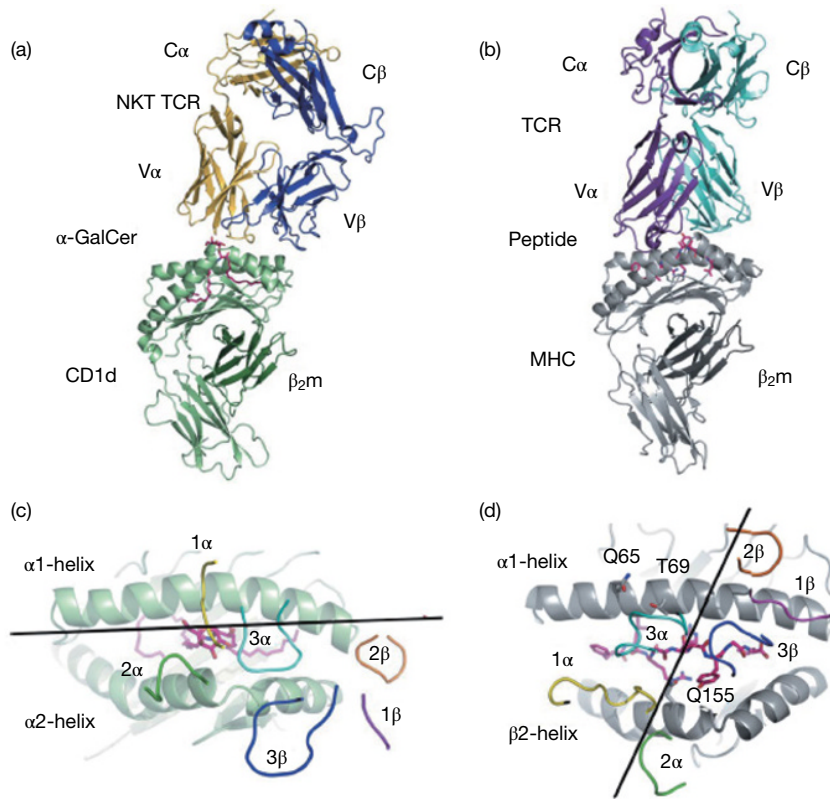


Figure 5.28 Comparison of TCR recognition of CD1d–lipid and MHC–peptide. (a) T-cell receptor (TCR) α -chain (yellow) and β -chain (blue) binding to α -galactosylceramide (magenta) presented by CD1d (green). (b) TCR α -chain (purple) and β -chain (cyan) binding to MHC (gray) and peptide (magenta). (c) Parallel docking mode seen with TCR (CDR1 α , yellow; CDR2 α , green; CDR3 α , cyan; CDR1 β , magenta; CDR2 β , orange; CDR3 β , blue) recognition of α -galactosylceramide (magenta) presented by CD1d (α -helices, pale green). (d) Diagonal docking mode of a typical TCR (CDR loops colored as in (c)) with peptide–MHC. In (c) and (d) the center of mass between the $V\alpha$ and $V\beta$ domain is indicated by the black line. (Source: Borg N.A. *et al.* (2007) *Nature* **448**, 44–49. Reproduced with permission of Nature Publishing Group.)

Superantigens are extremely powerful activators of T-cells

Bacterial pyogenic toxins can activate whole families of T-cells

The variable (V) gene sequences of the T-cell receptors can be grouped together into a number of families as previously described for the immunoglobulin V genes. Thus there are approximately 50 functional human TCR $V\beta$ genes which are grouped into 23 families (several of which only have one member), with some families much more highly represented in the repertoire than others. Whereas an individual peptide complexed to MHC will react with antigen-specific T-cells that represent a relatively small percentage of the T-cell pool because of the requirement for specific binding of peptide to particular $\alpha\beta$ TCR CDR3 regions, a special class of molecule has been identified that stimulates the approximately 5–20% of the total T-cell population expressing the same TCR $V\beta$ family structure. These molecules do this regardless of the antigen specificity of the receptor. They are referred to as

superantigens and do not need to be processed by the APC, instead cross-linking the class II and $V\beta$ independently of direct interaction between MHC and TCR molecules (Figure 5.29).

The pyogenic toxin superantigen family can cause food poisoning, fever, vomiting, and diarrhea and includes *Staphylococcus aureus* enterotoxins (SEA, SEB, and several others), staphylococcal toxic shock syndrome toxin-1 (TSST-1), streptococcal superantigen (SSA), and several streptococcal pyogenic exotoxins (SPEs). Although these molecules all have a similar structure, they stimulate T-cells bearing different $V\beta$ sequences. They are strongly mitogenic (i.e., stimulate mitosis) for these T-cells in the presence of MHC class II-expressing cells. SEA is one of the most potent T-cell mitogens known, causing dramatic proliferation in the concentration range 10^{-13} to 10^{-16} M. Like the other superantigens it can cause a “cytokine storm” involving the release of excessive amounts of IL-2, IFN γ , TNF α , TNF β (lymphotoxin), and other cytokines, and of mast cell leukotrienes, which form the basis for its ability to produce toxic shock syndrome.

Other T-cell superantigens

Other T-cell superantigens, not belonging to the pyogenic toxin superantigen family, include staphylococcal exfoliative toxins (ETs), *Mycoplasma arthritidis* mitogen (MAM), and *Yersinia pseudotuberculosis* mitogen (YPM). Polyclonal activation of T-cells can also occur in response to viral superantigens such as rabies virus nucleocapsid protein.

Microbes can also provide B-cell superantigens

There are a number of superantigens that are capable of stimulating a substantial proportion of B-lymphocytes. For example, staphylococcal protein A reacts not only with the Fc γ region of IgG but also with the 15–50% of antibodies that utilize the V $_H$ 3 family. The human immunodeficiency virus (HIV) glycoprotein gp120 also reacts with immunoglobulins that utilize V $_H$ 3 family members.

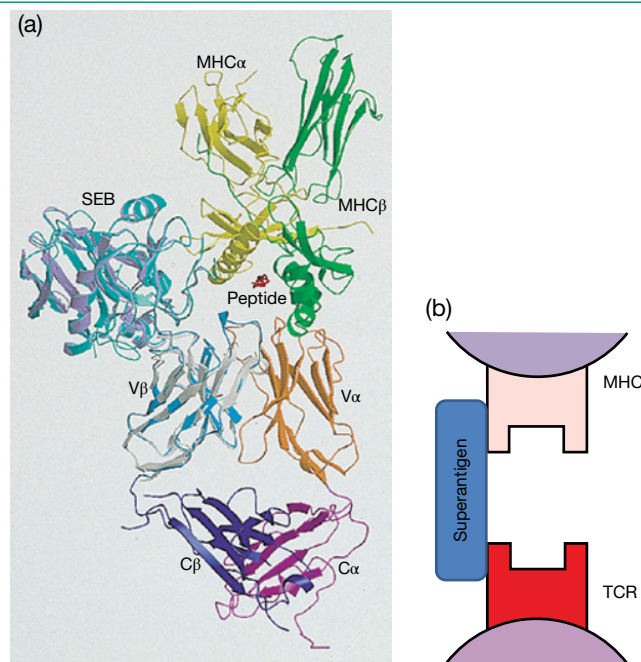


Figure 5.29 Interaction of superantigen with MHC and TCR. (a) In this composite model, the interaction with the superantigen staphylococcal enterotoxin B (SEB) involves SEB wedging itself between the T-cell receptor (TCR) V β chain and the MHC, effectively preventing interaction between the TCR and the peptide in the groove, and between the TCR β chain and the MHC. Thus direct contact between the TCR and the MHC is limited to V α amino acid residues. Other superantigens disrupt direct TCR interactions with peptide–MHC to varying extents, and in some cases (e.g., *Mycoplasma arthritidis* mitogen) there is no direct contact at all between the TCR and peptide/MHC. (Source: Li H. *et al.* (1999) *Annual Review of Immunology* 17, 435–466. Reproduced with permission of Annual Reviews.) (b) Superantigen cross-linking of MHC class II and the TCR V β .

Why do $\alpha\beta$ T-cells need to recognize antigen in such a complex way?

Antibodies combat pathogens and their products in the extracellular body fluids where they exist essentially in their native form (Figure 5.30a). Clearly it is to the host's advantage for the B-cell receptor to recognize epitopes on the *native molecules*. $\alpha\beta$ T-cells have quite a different job. In the case of cytotoxic T-cells they have to seek out and bind to the infected cells and carry out their effector function face to face with the target. The MHC molecules act as markers to tell the effector T-lymphocyte that it is encountering a cell and the processed peptide acts as a marker of infection (Figure 5.30b). Given that virtually all nucleated cells can become infected with some virus or other, it is necessary for the MHC class I cell marker to be expressed by all nucleated cells in the body because cytotoxic killing requires intimate cell contact between the effector cytotoxic CD8 $^+$ $\alpha\beta$ T-cell and the class-I-expressing target (infected) cell. In contrast, the secretion of cytokines by helper and regulatory T-cells does not require cell–cell contact between the effector and the responder cell. Thus the activation of the helper and regulatory T-cells can be handed over to designated professional APCs that, in addition to expressing MHC class I, also express the MHC class II which is required for presentation of peptides to these CD4 $^+$ $\alpha\beta$ T-cells.

A comparable situation of enforced cell contact arises when CD1 molecules present processed lipids, glycolipids, and lipoproteins to $\alpha\beta$ T-cells, $\gamma\delta$ T-cells, or NKT cells.

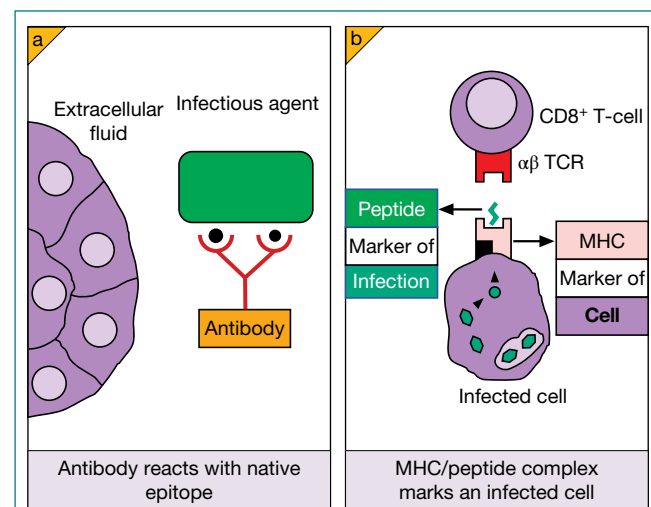


Figure 5.30 The fundamental difference between antibody and $\alpha\beta$ T-cell receptor (TCR) recognition of antigen. (a) Antibodies are formed against the native, not denatured, form of infectious agents that are attacked in the extracellular fluids. (b) Effector T-cells recognize infected cells by two surface markers: the MHC is a signal for the cell, and the foreign peptide is present in the MHC groove as it is derived from the proteins of an intracellular infectious agent. Further microbial cell surface signals can be provided by undegraded antigens and low molecular weight phosphate-containing antigens (seen by $\gamma\delta$ T-cells), and lipids and glycolipids presented by CD1 molecules.

Antibody recognition

- Antibodies recognize molecular shapes (epitopes) on antigens.
- Most protein epitopes are discontinuous, involving key residues from different parts of the linear sequence of the protein, although some are continuous and can be mimicked by linear peptides.
- The antibody-combining site forms a complementary surface to the epitope on the antigen and largely involves the CDRs of the antibody.
- Antibody-combining sites come in many shapes and sizes; antiprotein antibodies tend to have more extended recognition surfaces than antibodies to carbohydrates or peptides that are more likely to involve grooves or pockets.
- Both antibody and antigen can sometimes undergo local changes in conformation to permit interaction.

Eliciting antibodies

- Antigenicity (the ability of an antigen to be recognized by antibodies) can be distinguished from immunogenicity (the ability of an antigen (immunogen) to elicit antibodies when used to immunize an animal).
- Small molecule haptens only elicit antibodies when linked to a protein carrier molecule.
- Certain epitopes, usually those with the greatest accessibility on the surface of the protein (e.g., loops) elicit far stronger antibody responses than others.
- Many viruses, such as influenza and HIV, use the tendency of the antibody response to focus on immunodominant epitopes to “escape” antibody control.

Thermodynamics of antibody–antigen interaction

- Antibody–antigen interaction is reversible and subject to the laws of thermodynamics.
- The tendency of antibody and antigen to interact is reflected in a binding constant (K_a) and a free energy for the interaction (ΔG).
- Physiologically active antibodies mostly have binding constants of the order of $10^9/M$ (“nM binders”).
- The energetics of antibody–antigen interaction is dominated by a few “hotspots.”
- Multivalency can greatly enhance functional antibody affinity with significant physiological consequences (e.g., in toxin inactivation).
- High-affinity physiologically active antibodies generally have much lower affinities for antigens other than the target antigen (i.e., they have low cross-reactivity).

T-cell recognition

- $\alpha\beta$ T-cells see antigen in association with MHC molecules.
- The T-cells are restricted to the haplotype of the cell to which they were initially primed.

- Protein antigens are processed within cells to form small linear peptides that associate with the MHC molecules, binding to the central groove formed by the α -helices and the β -sheet floor.

Processing of antigen for presentation by class I MHC

- Endogenous cytosolic antigens such as viral proteins are cleaved by (*immuno*)**proteasomes** and the peptides so formed are **transported** to the ER by TAP1 and TAP2.
- The peptide then dissociates from the TAP molecules and forms a stable heterotrimer with newly synthesized class I MHC heavy chain and β_2 -microglobulin.
- This **peptide–MHC complex** is then transported to the cell surface for presentation to cytotoxic T-cells.

Processing of antigen for presentation by class II MHC

- The α and β chains of the **class II molecule** are synthesized in the ER and complex with membrane-bound **invariant chain (Ii)**.
- This facilitates transport of the vesicles containing class II across the Golgi and directs them to an acidified late endosome containing exogenous protein taken into the cell by endocytosis or phagocytosis.
- Proteolytic degradation of Ii in the class II enriched compartments (MIIC) leaves a peptide referred to as CLIP, which protects the MHC groove.
- Processing by endosomal proteases degrades the antigen to peptides, which replace the CLIP.
- The **class II–peptide** complex now appears on the cell surface for presentation to T-helper cells.

Cross-presentation

- Exogenous antigens can also be presented by MHC class I in dendritic cells through a pathway involving transfer into the cytosol followed by conventional proteasomal processing.
- By contrast, autophagy can transfer cytosolic peptides and proteins to the MIIC for subsequent presentation by class II.

The antigenic peptide

- Class I peptides are held in an extended conformation within the MHC groove.
- They are usually 8–10 residues in length and have two or three key **anchors**, relatively invariant residues that bind to allele-specific pockets in the MHC.
- Class II peptides are typically about 15–20 residues long, extend beyond the groove and usually have three or four anchor residues.
- The other amino acid residues in the peptide are greatly variable and are recognized by the T-cell receptor.

Complex between TCR, MHC and peptide

- The first and second hypervariable regions (CDR1 and CDR2) of each $\alpha\beta$ TCR chain mostly contact the MHC α -helices, while the CDR3s, having the greatest variability, interact with the antigenic peptide.

Some T-cells are independent of classical MHC molecules

- MHC class I-like molecules, such as murine H-2M3, are relatively nonpolymorphic and can present antigens such as bacterial *N*-formylmethionine peptides.
- The CD1 family of non-MHC class I-like molecules can present antigens such as lipid and glycolipid mycobacterial antigens.
- $\gamma\delta$ T-cells resemble antibodies in recognizing whole unprocessed molecules such as low molecular weight, phosphate-containing, nonproteinaceous molecules.

Superantigens

- These are potent mitogens that stimulate whole lymphocyte subpopulations sharing the same variable region family independently of antigen specificity.

- *Staphylococcus aureus* enterotoxins are powerful human T-cell superantigens that cause food poisoning and toxic shock syndrome.
- T-cell superantigens are not processed but cross-link MHC class II and TCR $V\beta$ independently of their direct interaction.
- Some superantigens (e.g., staphylococcal protein A) are capable of polyclonally activating B lymphocytes that utilize particular V_H family members.

Recognition of different forms of antigen by B- and T-cells

- B-cells recognize epitopes on the native antigen; this is important because antibodies react with native antigen in the extracellular fluid.
- Cytotoxic T-cells must contact infected cells and the infected cell signals itself to the T-cell by the combination of MHC class I and degraded antigen.
- Helper and regulatory T-cells also recognize antigen that has been broken down into peptides, but in this case the MHC involved is the class II molecule found only on professional antigen-presenting cells.



Now visit www.roitt.com to test yourself on this chapter.

FURTHER READING

- Adams E.J. and Luoma A.M. (2013) The adaptable major histocompatibility complex (MHC) fold: structure and function of nonclassical and MHC class I-like molecules. *Annual Review of Immunology* **31**, 529–561.
- Amigorena S. and Savina A. (2010) Intracellular mechanisms of antigen cross presentation in dendritic cells. *Current Opinion in Immunology* **22**, 109–117.
- Blum J.S., Wearsch P.A., and Cresswell P. (2013) Pathways of antigen processing. *Annual Review of Immunology* **31**, 443–473.
- Burton D.R., Pognard P., Stanfield R.L., and Wilson I.A. (2012) Broadly neutralizing antibodies present new prospects to counter highly antigenically diverse viruses. *Science* **337**, 183–186.
- Chapman H.A. (2006) Endosomal proteases in antigen presentation. *Current Opinion in Immunology* **18**, 78–84.
- Chien Y-H. (2014) $\gamma\delta$ T cells: first line of defense and beyond. *Annual Review of Immunology* **32**, 121–155.
- Crotzer V.L. and Blum J.S. (2009) Autophagy and its role on MHC-mediated antigen presentation. *Journal of Immunology* **182**, 3335–3341.
- Davies D.R. and Padlan E.A. (1990) Antibody–antigen complexes. *Annual Reviews of Biochemistry* **59**, 439–473.
- Davis S.J., Ikemizu S., Evans E.J., Fugger L., Bakker T.R., and van der Merwe P.A. (2003) The nature of molecular recognition by T-cells. *Nature Immunology* **4**, 217–224.
- De Libero G. and Mori L. (2012) Novel insights into lipid antigen presentation. *Trends in Immunology* **33**, 103–111.
- Finley D. (2009) Recognition and processing of ubiquitin-protein conjugates by the proteasome. *Annual Review of Biochemistry* **78**, 477–513.
- Fraser J.D. and Proft T. (2008) The bacterial superantigen and superantigen-like proteins. *Immunological Reviews* **255**, 226–243.
- Girardi E. and Zajonc D.M. (2012) Molecular basis of lipid antigen presentation by CD1d and recognition by natural killer T cells. *Immunological Reviews* **250**, 167–179.
- Godfrey D.I., Rossjohn J., and McCluskey J. (2008) The fidelity, occasional promiscuity, and versatility of T cell receptor recognition. *Immunity* **28**, 304–314.
- Mantegazza A.R., Magalhaes J.G., Amigorena S., and Marks M.S. (2013) Presentation of phagocytosed antigens by MHC class I and II. *Traffic* **14**, 135–152.
- Nowakowski A., Wang C., Powers D.B., et al. (2002) Potent neutralization of botulinum neurotoxin by recombinant oligoclonal antibody. *Proceedings of the National Academy of Sciences USA* **99**, 11346–11350.
- Padlan E.A. (1994) Anatomy of the antibody molecule. *Molecular Immunology* **31**, 169–217.
- Procko E., O'Mara M.L., Bennett W.F., Tieleman D.P., and Gaudet R. (2009) The mechanism of ABC transporters: general lessons from structural and functional studies of an

- antigenic peptide transporter. *The FASEB Journal* **23**, 1287–1302.
- Raghavan M., Cid N.D., Rizvi S.M., and Peters L.R. (2008) MHC class I assembly: out and about. *Trends in Immunology* **29**, 436–443.
- Roche P.A. and Furuta K. (2015) The ins and outs of MHC class II-mediated antigen processing and presentation. *Nature Reviews Immunology* **15**, 203–216.
- Rossjohn J., Pellicci D.G., Patel O., Gapin L., and Godfrey D.I. (2012) Recognition of CD1d-restricted antigens by natural killer T cells. *Nature Reviews Immunology* **12**, 845–857.
- Rudd P.M., Elliott T., Cresswell P., Wilson I.A., and Dwek R.A. (2001) Glycosylation and the immune system. *Science* **291**, 2370–2376.
- Salio M., Silk J.D., Jones E.Y., and Cerundolo V. (2014) Biology of CD1- and MR1-restricted T cells. *Annual Review of Immunology* **32**, 323–366.
- Segura E. and Amigorena S. (2015) Cross-Presentation in Mouse and Human Dendritic Cells. *Advances in Immunology* **127**, 1–31.
- Sela-Culang I., Kunik V., and Ofra Y. (2013) The structural basis of antibody-antigen recognition. *Frontiers in Immunology* **4**, 302.
- Sundberg E.J. and Mariuzza R.A. (2002) Molecular recognition in antibody–antigen complexes. *Advances in Protein Chemistry* **61**, 119–160.
- Tanaka K., Mizushima T., and Saeki Y. (2012) The proteasome: molecular machinery and pathophysiological roles. *Biological Chemistry* **393**, 217–234.
- van den Eynde B.J. and Morel S. (2001) Differential processing of class I-restricted epitopes by the standard proteasome and the immunoproteasome. *Current Opinion in Immunology* **13**, 147–153.
- Van Rhijn I., Godfrey D.I., Rossjohn J., and Moody D.B. (2015) Lipid and small-molecule display by CD1 and MR1. *Nature Reviews Immunology* **15**, 643–654.
- Vantourout P. and Hayday A. (2013) Six-of-the-best: unique contributions of $\gamma\delta$ T cells to immunology. *Nature Reviews Immunology* **13**, 88–100.
- Wearsch P.A. and Cresswell P. (2008) The quality control of MHC class I peptide loading. *Current Opinion in Cell Biology* **20**, 624–631.
- Wilson I.A. and Stanfield R.L. (1994) Antibody-antigen interactions: new structures and new conformational changes. *Current Opinion in Structural Biology* **4**, 857–867.

CHAPTER 6

The anatomy of the immune response

Key topics

■ The location of the immune system	168
■ The skin immune system	168
■ Mucosal immunity	169
■ The blood and lymphatic systems	171
■ Organized lymphoid tissue	174
■ Lymphocyte homing	175
■ Lymph nodes	177
■ Spleen	180
■ Bone marrow is a major site of antibody synthesis	180
■ The liver contains a variety of immune system cells	181
■ Immunologically privileged sites	181
■ The handling of antigen	182

Just to recap ...

Acquired immune responses are mediated by antigen-specific lymphocytes. The population frequency of each specificity is low, and therefore the relevant clones of lymphocytes are selected by antigen to be expanded up in number by extensive proliferation. Cytotoxic T-cells and most B-cells, both of which are antigen-specific, require assistance from antigen-specific helper T-cells. Furthermore, the CD4⁺ helper T-cells require antigen to be presented to them by MHC class II⁺ professional antigen-presenting cells. These stringent cellular interactions dictate that, unlike innate responses, the acquired immune responses need to be initiated in a highly structured environment.

Introduction

A fundamental difference between the immune and other body systems, such as the nervous, endocrine, and digestive systems, is that many of the cells involved in the immune response are highly motile. They use the *blood vessels* and *lymphatic vessels* in order to move into and out of organized *lymphoid tissue* and to reach the site of an infection. For an effective acquired immune response, an intricate series of cellular events must occur. Antigen must be detected and then processed by antigen-presenting cells (APCs), which subsequently make contact with and activate helper T-cells to stimulate B-cells and cytotoxic T-cell precursors. Additionally, various factors, such as cytokines, are required to support lymphocyte proliferation and bring about cellular differentiation. Memory cells for secondary responses must be formed and the whole response coordinated so that it is adequate but not excessive and is appropriate to the type of infection being dealt with. The integration of the complex cellular interactions that form the basis of the immune response takes place within the *secondary lymphoid tissue*, which consists of the *lymph nodes*, *spleen*, and the *mucosa-associated lymphoid tissue (MALT)* lining the respiratory, gastrointestinal, and genitourinary tracts.

The location of the immune system

The skin and mucosal outer surfaces of the body provide a first line of defense. If these are breached then the cells of what is conventionally referred to as the immune system will be encountered. Virtually all (the exception being the follicular dendritic cell) cells of the immune system are generated from *multipotent hematopoietic stem cells* in the *bone marrow*, and the majority of them mature within the bone marrow prior to being released into the blood circulation and subsequently entering the tissues. Cells of the innate response are found throughout the body. For example, resident tissue macrophages, mast cells in connective and mucosal tissues, NK cells in many locations, neutrophils recruited to the site of an infection, and so on. With respect to the lymphocytes of the adaptive response, although the *B-cells* become fully mature within the *bone marrow*, *T-cell* precursors must travel from

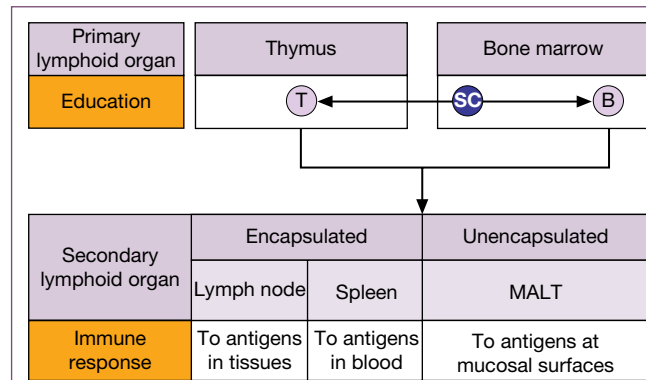


Figure 6.1 The functional organization of lymphoid tissue. Hematopoietic stem cells (SC) arising in the bone marrow differentiate into immunocompetent T- and B-cells in the primary lymphoid tissues and then colonize the secondary lymphoid tissues where immune responses are organized. The mucosa-associated lymphoid tissue (MALT), together with diffuse collections of cells in the lamina propria, produces antibodies for mucosal secretions.

the bone marrow to the *thymus* where they reach full maturity (Figure 6.1). The bone marrow and thymus are therefore referred to as the *primary lymphoid tissue* – the location where mature lymphocytes are produced. Any location in the body outside of the primary lymphoid tissues is referred to by immunologists as the “periphery.” The initiation of adaptive immune responses by lymphocytes takes place in specialized areas of the periphery – the *secondary lymphoid tissues* (MALT, lymph nodes, and spleen).

The term “leukocyte” is used to describe the white blood cells but one should remain cognizant of the fact that the blood circulation acts largely as a distribution network for these cells and that they carry out their functions mostly within the lymphoid and other body tissues. This may be a good point at which to pose the question, how does one categorize a cell as belonging to the immune system? Like many very simple questions there is no easy answer to this one. Thus, erythrocytes are perhaps not usually considered a part of the immune system despite the fact that their possession of complement receptors provides them with an important role on the clearance of immune complexes from the circulation. Likewise endothelial cells are also not normally classed as cells of the immune system despite their fundamental role in alerting leukocytes to an infection. The message here is clear: Mother Nature does not compartmentalize the different body systems in the rigid way that we sometimes try to.

The skin immune system

Pathogens will usually first be encountered at body surfaces, either the skin or the mucosae and these are therefore endowed with a variety of barriers against infection (see Figure 1.6). The outer surface of the skin is composed of *keratinocytes* which constitute a strong *physical barrier* against microorganisms.

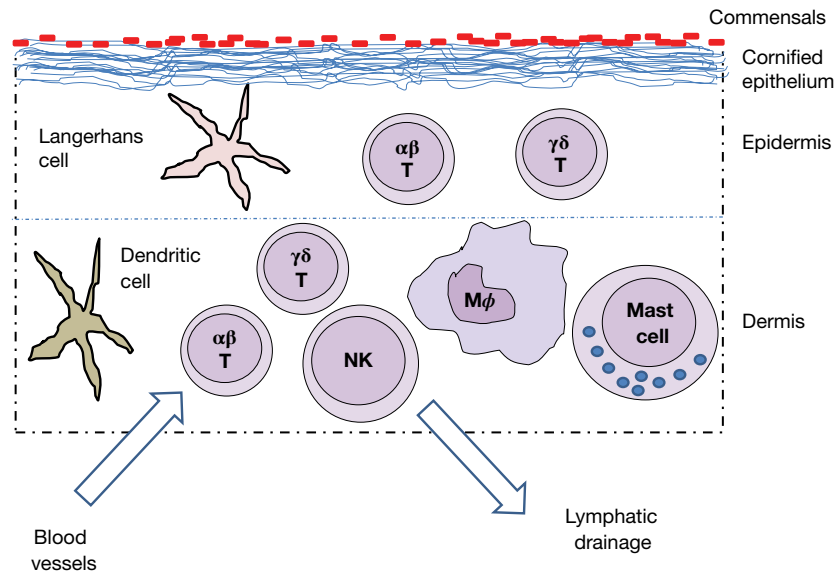


Figure 6.2 The skin immune system. Commensal organisms on the surface of the skin, together with the physical and chemical barrier function of this tissue, protect the body from infection. For those organisms that overcome these defenses both the epidermis beneath the cornified epithelium as well as the underlying dermis are well protected by cells of both the innate and the adaptive responses. The Langerhans cells in the epidermis and dermal dendritic cells share many properties but there is some evidence that the Langerhans cells may be particularly involved in the development of Th17-mediated immunity against skin pathogens such as *Staphylococcus aureus* and *Candida* and in the induction of immunological tolerance to commensal microorganisms, whereas the dermal dendritic cells are perhaps more focused on initiating protective immune responses against viruses involving Th1 cells and CD8⁺ cytotoxic T-cells.

In addition, keratinocytes express many types of **pattern recognition receptors**, including TLRs, NOD-like receptors, RIG-1-like receptors, and C-type lectins. Upon detection of pathogens, these receptors trigger the keratinocytes to produce **microbicidal compounds** such as β -defensins as well as a variety of **cytokines** (including **chemokines**, a family of molecules with chemotactic and other functions). In a normal, non-inflamed state the **epidermis** contains resident **Langerhans cells** and both $\alpha\beta$ and $\gamma\delta$ **T-cells** (Figure 6.2). The Langerhans cells can promote Th17 responses against extracellular pathogens and may also regulate the development of tolerance against nonpathogenic antigens.

The underlying **dermis** contains **dendritic cells**, **macrophages**, **T-cells** (again both $\alpha\beta$ and $\gamma\delta$), **NK cells**, and **mast cells**. About 10% of human CD4⁺ T-cells in the skin express Foxp3, indicating that these cells may function as regulatory T-cells. There is a continuous migration of leukocytes into the dermis from the blood vessels. T-cells that are directed to migrate to the skin upregulate a number of adhesion molecules, including cutaneous leukocyte antigen (CLA), CD43, and CD44, all three of which bind to E-selectin on the blood vessel endothelium in the skin. LFA-1 and Mac-1 binding to ICAM-1, and VLA-4 binding to VCAM-1, as well as CCR4 on the T-cell binding to CCL17 on the blood vessel endothelium, are also involved in this process (Figure 6.3). The T-cells can subsequently return to the circulation via the draining lymphatics and the lymph nodes. Should a pathogen provoke an inflammatory reaction in the skin, then other cells of the

immune system will fairly rapidly appear on the scene, including **neutrophils**, **monocytes**, and **eosinophils**. In diseases such as atopic eczema the number of leukocytes in the skin increases substantially.

Mucosal immunity

The other “outer” surface of the body is the mucosa. Most pathogens enter the body through mucosal surfaces, following ingestion, inhalation, or sexual transmission. The gastrointestinal, respiratory, and genitourinary tracts (Figure 6.4) are therefore heavily guarded by cells of the immune system present in the highly vascularized lamina propria (connective tissue) which lies beneath the epithelial cells (Figure 6.5). There are **diffuse collections** of T- and B-lymphocytes (Figure 6.5a) as well as antibody-secreting plasma cells (Figure 6.5b) and phagocytes. Additionally many of the lymphocytes are **organized** into **mucosa-associated lymphoid tissue (MALT)** with well-formed follicles. In humans, the MALT includes the lingual, palatine, and pharyngeal tonsils, the Peyer’s patches of the small intestine (Figure 6.5c), and the appendix.

Gut-associated lymphoid tissue is separated from the lumen of the intestine by columnar epithelium with tight junctions and a mucous layer. This epithelium is interspersed with microfold (M)-cells (Figure 6.5d and Figure 6.6). These are specialized antigen-transporting cells with short, irregular microvillae on their apical surface. They endocytose antigens that are then carried to the basal surface where they are exocytosed for the

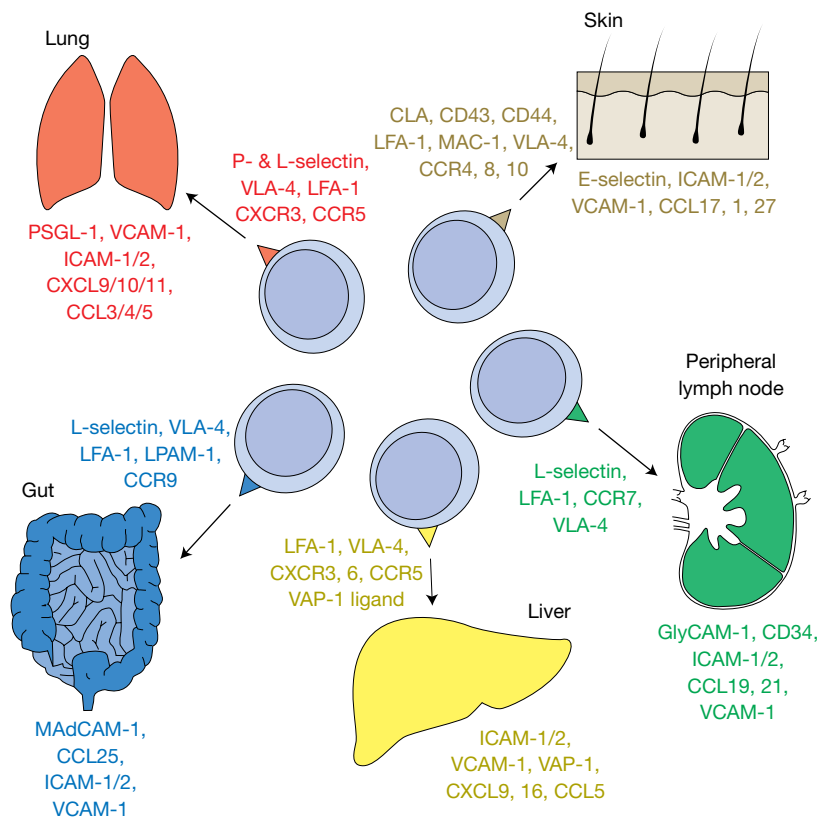


Figure 6.3 Access to tissues requires the correct address code. T-cells (and also dendritic cells) destined for various locations carry a combination code of cell surface molecules that recognize their respective ligands on the vascular endothelium at their destination. Some ligand–ligand pairs are the same irrespective of the destination tissue, such as LFA-1 binding to ICAM-1 and -2, and VLA-4 ($\alpha_4\beta_1$) integrin binding to VCAM-1. Other interactions utilize adhesion molecules that bind to ligands expressed at specific locations. For example, the recognition of E-selectin by CLA (cutaneous lymphocyte antigen), CD43 and CD44 assists in directing skin-bound lymphocytes to the correct location. L-selectin recognizes GlyCAM-1 and CD34 on peripheral lymph node endothelium but recognizes MAdCAM-1 (mucosal vascular addressin cell adhesion molecule-1) on gut endothelium. Both L- and P-selectin bind PSGL-1 (P-selectin glycoprotein ligand-1) on lung endothelium. In addition, chemokine receptors (see Table 8.2) recognize tissues displaying particular chemokines.

subsequent attention of lymphocytes, dendritic cells, and macrophages (Figure 6.6b,c). Collectively, the cells and tissues involved in mucosal immunity form an interconnected system within which lymphocytes may circulate (Figure 6.7).

Peyer's patches form the site for induction of immune responses in the gut

Foreign material, including bacteria, is taken up by M-cells and passed on to the underlying Peyer's patch APCs, which then activate the appropriate lymphocytes. Thus, the *Peyer's patches* constitute the *inductive site* for the initiation of gut immune responses. After their activation is induced, the lymphocytes travel via the lymph to the mesenteric lymph nodes where additional activation and proliferation may occur. A special feature of APCs from Peyer's patches, mesenteric lymph nodes, and the lamina propria is that they contain a population of CD103⁺ dendritic cells that express retinal dehydrogenase enzymes which convert vitamin A to retinoic acid. Why is this

relevant? Well, because it turns out that stimulation through lymphocyte retinoic acid receptors (RARs) induces T-cells to upregulate both the LPAM-1 ($\alpha_4\beta_7$) integrin and the CCR9 gut homing receptors, as well as enhancing the differentiation of Foxp3⁺ regulatory T-cells and favoring the generation of IgA-producing B-cells. The “imprinted” T-lymphocytes then move via the thoracic duct into the bloodstream and finally on to the *lamina propria* of the gut (Figure 6.7). In this *responsive site* the activated T-cells assist the IgA-forming B-cells and plasma cells that, because they are now broadly distributed, protect a wide area of the gut with antibody. Thus, superimposed upon a common mucosal immune system, lymphocytes can be directed to particular mucosal locations.

Intestinal lymphocytes

The LPAM-1 ($\alpha_4\beta_7$) integrin ligand MAdCAM-1 is present on the intestinal lamina propria postcapillary venules (Figure 6.8) and thus facilitates the arrival of the LPAM-1⁺ intestinal T-cells.

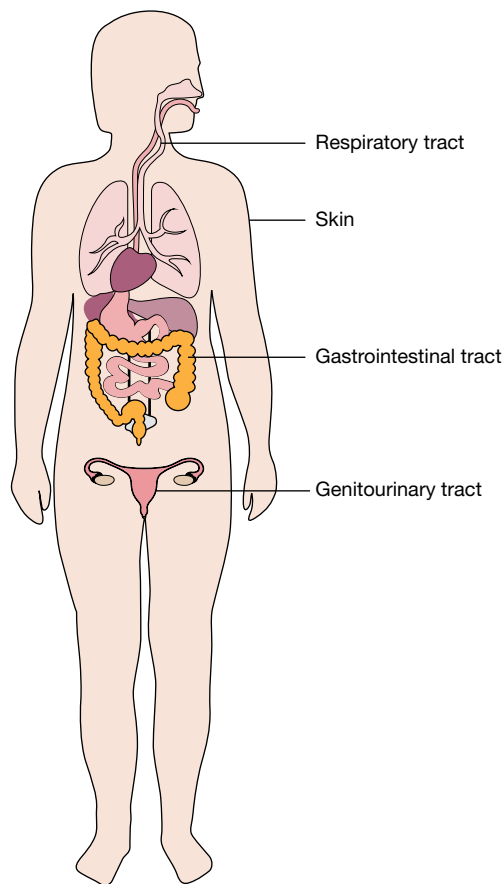


Figure 6.4 Mucosal protection. Most infectious agents enter the body via the mucosal surfaces in the respiratory, gastrointestinal, or genitourinary tracts. These locations are therefore heavily protected by the immune system.

These cells bear a phenotype roughly comparable to that of peripheral blood lymphocytes – namely >95% T-cell receptor (TCR) $\alpha\beta$ and a CD4:CD8 ratio of 7 : 3 – and seem to mainly be activated or memory cells. Unwarranted immune responses in the gut may be dampened down following the secretion of IL-10 and transforming growth factor β (TGF β) by inducible regulatory T-cells. Within the lamina propria there is also a generous sprinkling of activated B-cells and of plasma cells secreting IgA for transport by the poly-Ig receptor to the intestinal lumen (see Figure 6.5b).

Intestinal *intraepithelial lymphocytes* (IELs) are a distinctly different population. Both they and intraepithelial dendritic cells express high levels of the $\alpha_E\beta_7$ -integrin, which binds E-cadherin on the intestinal epithelial cells, thereby localizing the IELs between the epithelial cells (Figure 6.9). They are mostly T-cells, about 10% of which in humans bear a $\gamma\delta$ TCR. In other species, including mice, $\gamma\delta$ T-cells can represent up to 60% of the IEL T-cells.

Of those bearing an $\alpha\beta$ TCR, most IELs are CD8⁺ positive and in mice can be divided into two populations. One-third of

them possess the conventional form of CD8, which is a heterodimer composed of a CD8 α chain and a CD8 β chain. However, two-thirds of them instead express a **CD8 $\alpha\alpha$ homodimer**, which is almost exclusively found only on IELs. The existence of CD8 $\alpha\alpha$ TCR $\alpha\beta$ T-cell IELs in humans has only been confirmed in fetal but not in adult intestine. Those IELs that are conventional T-cells with an $\alpha\beta$ TCR and a CD8 $\alpha\beta$ heterodimer recognize peptide–MHC. However, $\alpha\beta$ TCR IELs that express CD8 $\alpha\alpha$ are efficiently generated in both class I and CD1 knockout mice and therefore do not recognize antigen presented by either of these molecules. At least some of these IELs appear to be restricted by nonclassical MHC molecules, such as TL in mice, and act as a relatively primitive first line of defense at the outer surfaces of the body.

CD8 $\alpha\alpha$ homodimer $\gamma\delta$ T-cells are present in both human and mice. The MHC class I chain-related (MIC) family members MICA and MICB are recognized by many human $\gamma\delta$ TCR IELs.

Reflect for a moment on the fact that roughly 10^{14} bacteria reside in the intestinal lumen of the normal adult human. During an infection many of these will be pathogens rather than friendly commensals. Combined with the barrier of mucus produced by goblet cells and the protective zone of secreted IgA antibodies, these collections of intestinal lymphocytes represent a crucial line of defense. Indeed, the number of IELs in the small intestine of the mouse accounts for nearly 50% of the total number of T-cells in all lymphoid organs.

Other mucosal sites

T- and B-cells appear in the lymphoid tissue of the lung and in other mucosal sites guided by the interactions of specific homing receptors with appropriate HEV addressins (Figure 6.3). Chemokines and their receptors also play an important role in this process. For example, the CXCL10 and CCL5 chemokines are expressed in the lungs and detected by CXCR3 and CCR5, respectively, on lung homing T-cells (Figure 6.3).

The blood and lymphatic systems

As mentioned already, many cells of the immune system, particularly lymphocytes, NK cells, monocytes, neutrophils, eosinophils, and basophils travel around the body in the blood and lymph. Both the blood vessels and lymphatic vessels are lined with a type of epithelial cell referred to as *endothelium*. As infectious agents can, collectively, infect any organ or tissue, this motility of the immune system is essential in order to protect the whole body. Leukocytes are carried through the blood circulation by the pumping action of the heart, and travel from the heart through the arteries to eventually reach the capillaries found throughout the tissues. The leukocytes can continue their journey in the veins, which contain internal valves to ensure the blood continues to flow in the correct direction, eventually leading back to the heart. Thus leukocytes can go around the body again and again via the blood circulation. The system of lymphatic vessels (Figure 6.10) is also distributed

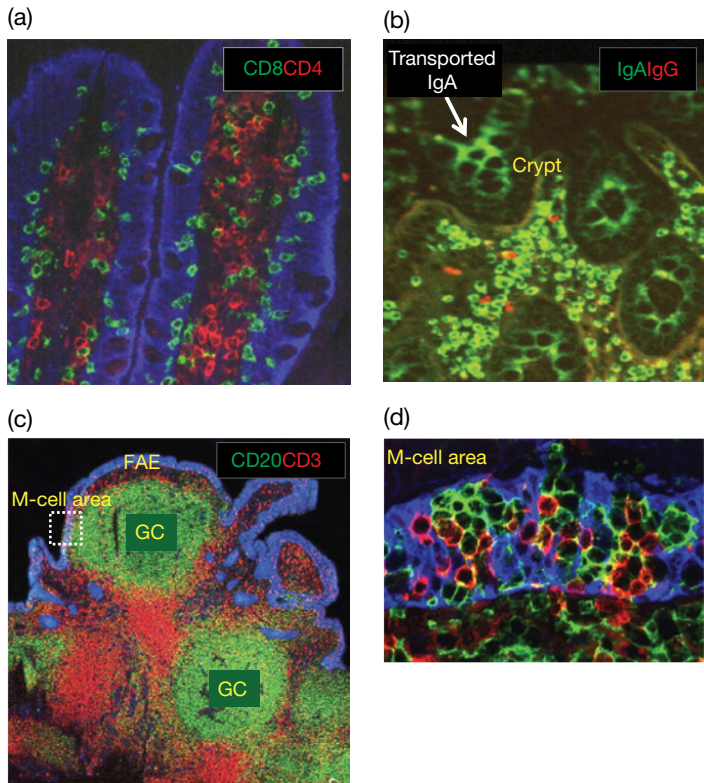


Figure 6.5 Gut-associated immunity. (a) Staining for CD8 (green) and CD4 (red) T-cells in human duodenal mucosa. The epithelium of the villi is blue (cytokeratin). The weak CD4 expression seen in the background is either macrophages or dendritic cells. (b) Staining for IgA (green) and IgG (red) in a section of human large bowel mucosa. Crypt epithelium shows selective transport of IgA. Only a few scattered IgG-producing cells are seen in the lamina propria, together with numerous IgA plasma cells (staining bright green). (c) Immunofluorescence staining indicating the B-cells (with anti-CD20, green), T-cells (with anti-CD3, red) and the follicle-associated epithelium (FAE) (with anti-cytokeratin, blue) in Peyer's patch of human small intestine. GC, germinal center; M-cell, microfold cell. (d) Details from the antigen-sampling microfold-cell (M-cell) area. (Source: Brandtzaeg P. and Pabst R. (2004) *Trends in Immunology* 25, 570–577. Reproduced with permission of Elsevier.)

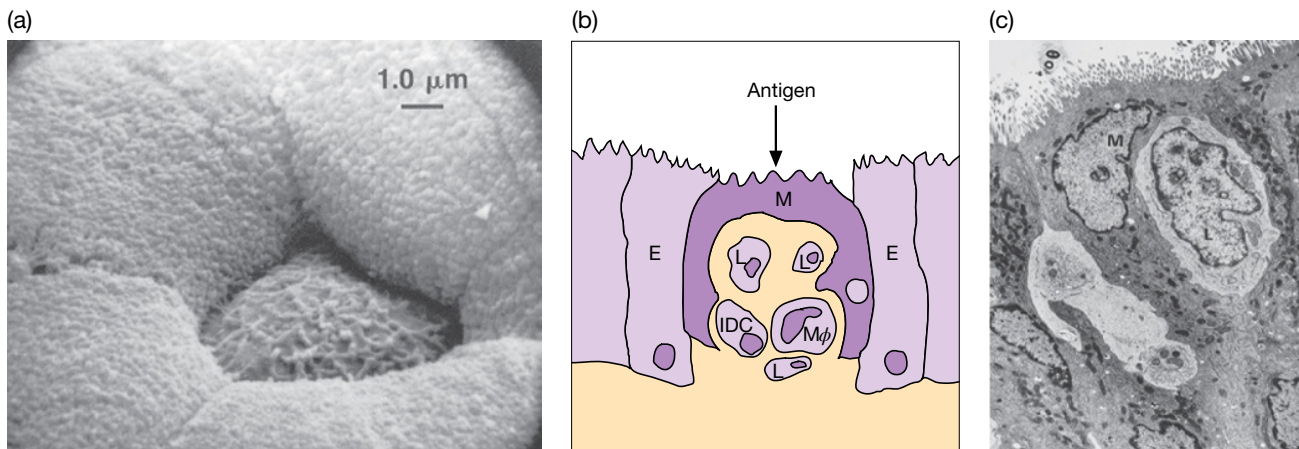


Figure 6.6 M-cell within Peyer's patch epithelium. (a) Scanning electron micrograph of the surface of the Peyer's patch epithelium. The antigen-sampling M-cell in the center is surrounded by absorptive enterocytes covered by closely packed, regular microvilli. Note the irregular and short microfolds of the M-cell. (Source: Kato T. and Owen R.L. (1999) In Ogra R. *et al.* (eds) *Mucosal Immunology*, 2nd edn. Academic Press, San Diego. Reproduced with permission.) (b) After uptake and transcellular transport by the M-cell (M), antigen is processed by macrophages and dendritic cells, which present antigen to T-cells in Peyer's patches and mesenteric lymph nodes. E, enterocyte; IDC, interdigitating dendritic cell; L, lymphocyte; Mø, macrophage. (Adapted from Sminia T. and Kraal G. (1998) In Delves P.J. and Roitt I.M. (eds.) *Encyclopedia of Immunology*, 2nd edn., p. 188. Academic Press, London.) (c) Electron photomicrograph of an M-cell (M in nucleus) with adjacent lymphocyte (L in nucleus). Note the flanking epithelial cells are both absorptive enterocytes with a typical brush border. (Lead citrate and uranyl acetate, $\times 1600$.)

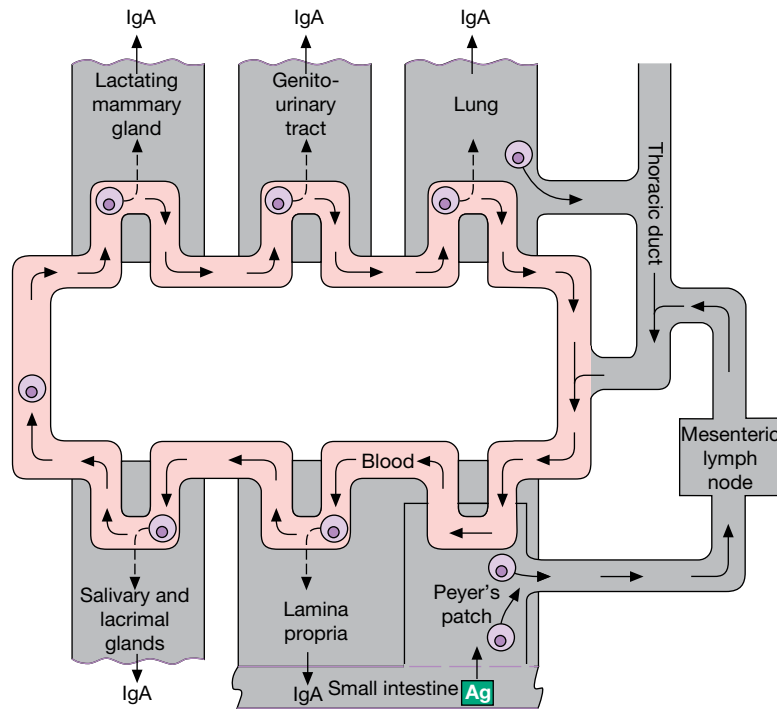


Figure 6.7 Circulation of lymphocytes within a common mucosal immune system. The different mucosal tissues are connected to each other by the blood circulation, enabling lymphocytes and other cells of the immune system to travel from one mucosal tissue to other mucosal tissues. For example, lymphocytes initially activated by antigen in the Peyer's patches of the small intestine and then subsequently activated in the mesenteric lymph nodes can colonize the lamina propria of other mucosal tissues. This connectively forms what has been described as a common mucosal immune system.

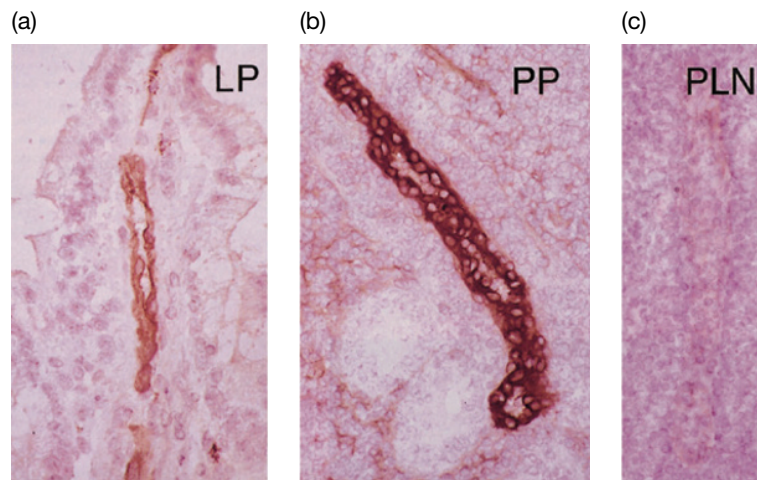


Figure 6.8 Selective expression of the mucosal vascular addressin MAdCAM-1 on endothelium involved in lymphocyte homing to gastrointestinal sites. Immunohistologic staining reveals the presence of MAdCAM-1 (a) on postcapillary venules in the small intestinal lamina propria (LP) and (b) on high-walled endothelium of the postcapillary venules (HEVs) in Peyer's patches (PP), but its absence from (c) HEV in peripheral lymph nodes (PLN). (Source: Butcher E.C. *et al.* (1999) *Advances in Immunology* **72**, 209. Reproduced with permission.)

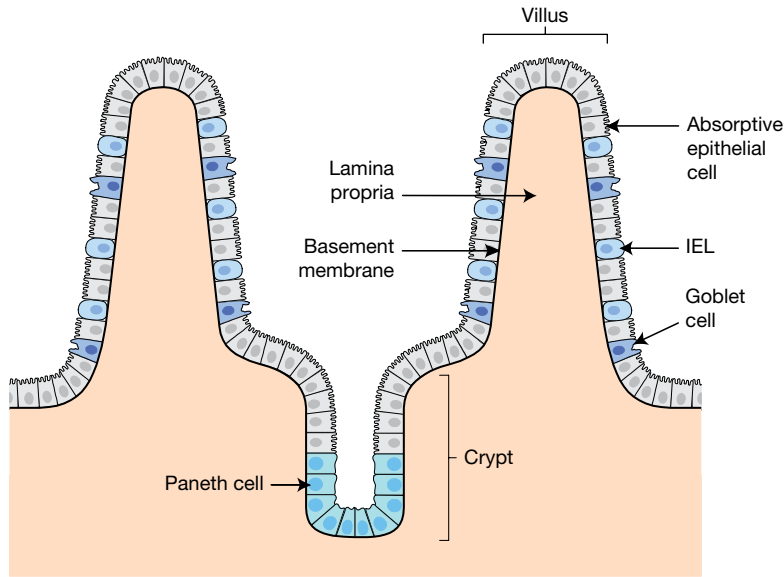


Figure 6.9 Intraepithelial lymphocytes (IELs). IELs are seen interspersed among the epithelial cells of the villi in the intestine. The absorptive cells with prominent microvilli digest and absorb nutrients, the goblet cells secrete mucus, and the Paneth cells in the crypts secrete lysozyme and defensins.

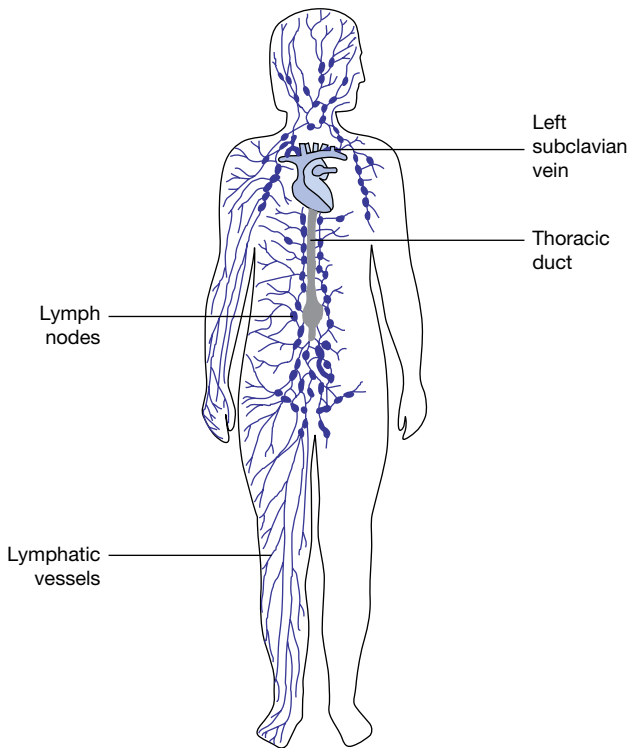


Figure 6.10 The network of lymph nodes and lymphatics. Lymph nodes occur at junctions of the draining lymphatics. The lymph finally collects in the thoracic duct and in the right lymphatic duct and thence returns to the bloodstream via the left subclavian vein or the right subclavian vein, respectively.

throughout the body and makes physical connections with the blood circulation in the thorax (the chest). Here a lymphatic vessel called the **thoracic duct** (also referred to as the left lymphatic duct) joins up with the left subclavian vein, while the **right lymphatic duct** joins to the right subclavian vein.

Small lymphatic capillaries collect interstitial fluid (the fluid that surrounds and bathes cells) and join up with each other to form the **afferent lymphatic vessels**. The various motile cells of the immune system, and any pathogens or fragments of pathogens that might be present, can also be carried with the interstitial fluid into the afferent lymphatics. The fluid is now referred to as **lymph** and moves through the lymphatic vessels because of the peristaltic activity of the vessels coupled with valves that ensure unidirectional flow. The afferent lymphatic vessels eventually enter organized lymphoid structures called **lymph nodes**. The lymph can subsequently leave the lymph nodes via the **efferent lymphatic vessels**, and will eventually mix with the blood using the connections we have described earlier.

Organized lymphoid tissue

The role of the **bone marrow** in hematopoiesis and of the **thymus** in T-cell development will be discussed in Chapter 10.

As already discussed, the **MALT** deals with antigens present at mucosal surfaces. In contrast, the **lymph nodes** receive antigen either draining directly from the tissues or carried by dendritic cells, and the **spleen** monitors the blood. The anatomical location of these lymphoid tissues is illustrated in Figure 6.11. Immunological communication between these tissues and the rest

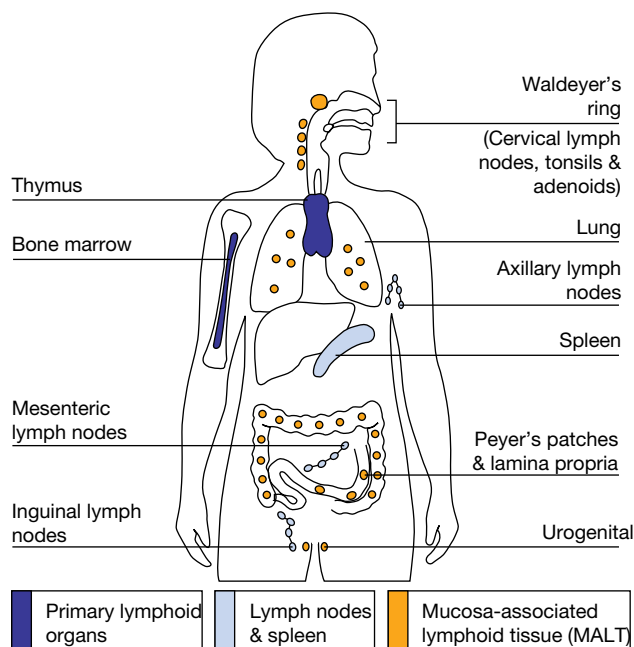


Figure 6.11 The distribution of major lymphoid tissues throughout the body.

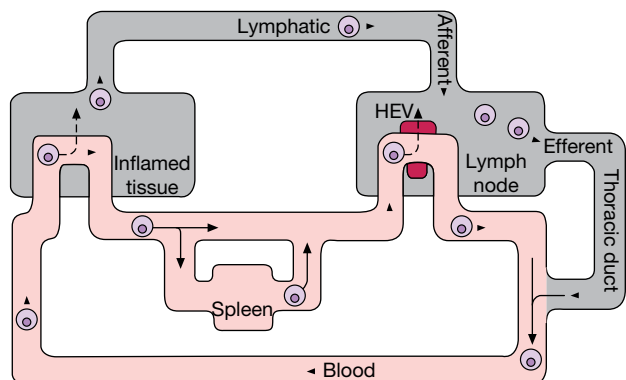


Figure 6.12 Traffic and recirculation of lymphocytes through encapsulated lymphoid tissue and sites of inflammation. Blood-borne lymphocytes enter inflamed tissues when they recognize upregulated adhesion molecules on the blood vessel endothelium and enter lymph nodes by passing through the high-walled endothelium of the postcapillary venules (HEV). They leave via the draining lymphatics. The efferent lymphatics join to form the thoracic duct, which returns the lymphocytes to the bloodstream. In the spleen, which lacks HEVs, lymphocytes enter the lymphoid area (white pulp) from the arterioles, pass to the sinusoids of the erythroid area (red pulp) and leave by the splenic vein (see Figure 6.16b). Traffic through the mucosal immune system was illustrated in Figure 6.7.

of the body is maintained by a pool of recirculating lymphocytes that, as already discussed, passes from the blood into the lymph nodes, spleen and other tissues and back to the blood by the major lymphatic channels such as the thoracic duct (Figure 6.12).

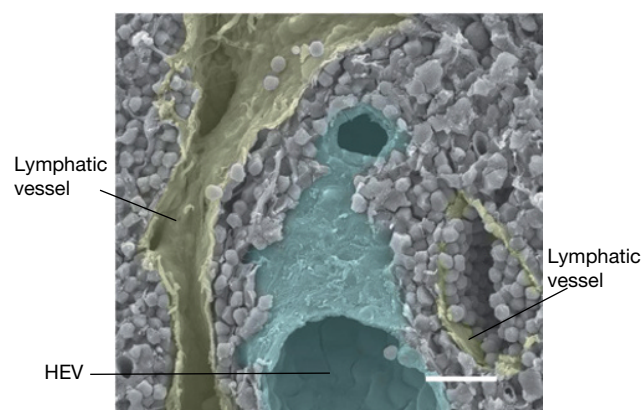


Figure 6.13 High-walled endothelial venule (HEV). Scanning electronic micrograph of rat mesenteric lymph node showing loosely packed lymphocytes around an HEV (blue) and lymphatic vessels (yellow). (The black hole at the top of the HEV is an artifact where a tributary of the HEV was lost during preparation.) The lymph node was sliced with a vibratome that removes many of the free lymphocytes from the lumen of the HEV and the lymphatic vessels. Scale bar = 20 μm . (Source: O. Ohtani. Reproduced with permission.)

Lymphocyte homing

This traffic of lymphocytes throughout the body enables these antigen-specific cells to seek “their” antigen and to be deployed to sites at which a response is required. When antigen reaches a lymph node in a primed animal, there is a dramatic fall in the output of cells in the efferent lymphatics, a phenomenon described variously as “cell shutdown” or “lymphocyte trapping.” This process involves a reduced responsiveness of lymphocytes to sphingosine 1-phosphate (S1P), a molecule that signals lymphocytes to exit the lymph node. The shutdown phase is followed by an output of activated cells that peaks at around 80 hours.

Naive lymphocytes home to lymph nodes

Naive lymphocytes can enter a lymph node either in the lymphatic fluid (lymph) draining into the node via the afferent lymphatics or by exiting from the bloodstream across the specialized **high-walled endothelium of the postcapillary venules (HEV)** (Figure 6.13). If arriving via the HEV, their entry is determined by a series of **homing receptors** on the lymphocyte that include the **integrin** superfamily member LFA-1 ($\alpha\beta_2$, Table 6.1), the selectin family member L-selectin, and the chemokine receptor CCR7. Their ligands on the endothelium act as **vascular addressins**. Thus, L-selectin recognizes Lewis^x oligosaccharide structures present on a variety of glycoproteins on the HEVs (including GlyCAM-1 and CD34) and generally referred to as peripheral node addressins (PNAd) (Figure 6.3). Chemokines presented by

Table 6.1 The integrin superfamily. In general, the integrins are concerned with intercellular adhesion and adhesion to extracellular matrix components. Various members are involved in embryogenesis, cell growth, differentiation, motility, programmed cell death, and tissue maintenance. Many of them are also involved in cell signal transduction. They are $\alpha\beta$ heterodimers selected from 18 α chains and 8 β chains, which pair to form 24 different combinations. A structure called the I (inserted) domain is present in many integrin subunits and contains the metal ion-dependent adhesion site (MIDAS) that, in the presence of Mg^{2+} , is involved in binding the Arg–Gly–Asp (RGD) motif on many of the ligands essential for cell adhesion. The $\alpha_v\beta_3$ - and $\alpha_v\beta_5$ -integrin ligand MFG-E8 is expressed by a variety of cell types, including IDC and macrophages in secondary lymphoid tissues where it plays a role in phagocytosis of apoptotic B-cells. LAP binds to, and thereby inhibits, the activity of TGF β .

Integrin	CD designation*	Expression	Ligand
$\alpha_1\beta_1$ (VLA-1)	CD49a/CD29	Widespread	CO, LM
$\alpha_2\beta_1$ (VLA-2)	CD49b/CD29	Widespread	CO, LM, THR
$\alpha_3\beta_1$ (VLA-3)	CD49c/CD29	Widespread	LM, THR
$\alpha_4\beta_1$ (VLA-4)	CD49d/CD29	Widespread	CD14, FN, MADCAM-1, OP, THR, VCAM-1
$\alpha_5\beta_1$ (VLA-5)	CD49e/CD29	Widespread	FN, OP
$\alpha_6\beta_1$ (VLA-6)	CD49f/CD29	Widespread	LM
$\alpha_7\beta_1$	–/CD29	Widespread	LM
$\alpha_8\beta_1$	–/CD29	Widespread	FN, OP, TN, VN
$\alpha_9\beta_1$	–/CD29	Widespread	OP, TN, VECAM-1
$\alpha_{10}\beta_1$	–/CD29	Widespread	CO, LM
$\alpha_{11}\beta_1$	–/CD29	Musculoskeletal	CO
$\alpha_v\beta_1$	CD51/CD29	Most leukocytes	FN, LAP-TGF β , OP
$\alpha_L\beta_2$ (LFA-1)	CD11a/CD18	Most leukocytes	ICAM-1,-2,-3,-4, JAM-1
$\alpha_M\beta_2$ (CR3 [Mac-1])	CD11b/CD18	N, Mo, M ϕ	C3bi, FG, FX, ICAM-1,-4
$\alpha_X\beta_2$ (p150, 95)	CD11c/CD18	IDC, IEL, NK, Mo, M ϕ	C3bi, CO, FG, ICAM-1,-2,-4 VCAM-1
$\alpha_D\beta_2$	CD11d/CD18	M ϕ	ICAM-3, VECAM-1
$\alpha_{IIb}\beta_3$ (GPIIb/IIIa)	CD41/CD61	Megakaryocytes, platelets	FG, FN, THR, VN, VWF
$\alpha_v\beta_3$	CD51/CD61	Widespread	BSP, DEL-1, FG, FIBRILLIN, FN, LAP-TGF β , MFG-E8, OP, PECAM-1, THR, TN, VN, VWF
$\alpha_6\beta_4$	CD49f/CD104	Epithelium, endothelium, Schwann cells, T-cells	LM
$\alpha_v\beta_5$	CD51/–	Widespread	BSP, DEL-1, MFG-E8, OP, VN
$\alpha_v\beta_6$	CD51/–	Epithelium	FN, LAP-TGF β , OP
$\alpha_4\beta_7$ (LPAM-1)	CD49d/–	T-cells, B-cells	FN, MAdCAM-1, OP, VCAM-1
$\alpha_E\beta_7$	CD103/–	IEL	E-cadherin
$\alpha_v\beta_8$	CD51/–	Neurons	LAP-TGF β

BSP, bone sialoprotein; CO, collagen; CR3, complement receptor 3; DEL-1, developmental endothelial locus-1; FG, fibrinogen; FN, fibronectin; FX, factor X; GPIIb/IIIa, integrin glycoproteins IIb and IIIa; ICAM, intercellular adhesion molecule; IDC, interdigitating dendritic cell; IEL, intraepithelial lymphocyte; JAM-1, junctional adhesion molecule-1; LAP-TGF β , latency-associated peptide – transforming growth factor- β complex; LFA, leukocyte function-associated molecule; LM, laminin; LPAM, lymphocyte Peyer's patch adhesion molecule; M ϕ , macrophage; MAdCAM, mucosal addressin cell adhesion molecule; MFG-E8, milk fat globule epidermal growth factor-8; MMP, matrix metalloproteinase; Mo, monocyte; N, neutrophil; NK, natural killer cell; NN, nephronectin; OP, osteopontin; THR, thrombospondin; TN, tenascin; VCAM, vascular cell adhesion molecule; VLA, very late antigen (although they are not all expressed late!); VN, vitronectin; VWF, von Willebrand factor.

* CD markers are explained in Table 10.1. –, no CD designation yet assigned.

vascular endothelium play a key role in triggering lymphocyte arrest, the chemokine receptors on the lymphocyte being involved both in binding to their ligand and in the functional activation of integrins.

Therefore, naive lymphocytes, and also dendritic cells, by expressing the CCR7 chemokine receptor are directed into peripheral lymph nodes because the HEVs in the nodes display the chemokines CCL19 and CCL21 (see Table 8.2) on their luminal surface. While CCL21 is produced by the endothelial cells themselves, CCL19 is secreted by the network of fibroblastic reticular cells (FRCs) within the lymph node and subsequently transferred to the HEV. The *plt/plt* mouse, which lacks expression of both of these chemokines, not unsurprisingly exhibits defective T-cell migration into peripheral lymph nodes. Chemokine activation of integrins occurs as a result of the chemokine signals facilitating their lateral mobility in the cell membrane and also by inducing structural changes in the integrins that increases their affinity for their ligands.

Passage through the HEV into the lymph node occurs in three stages

Stage 1: Tethering and rolling

In order for the lymphocyte to become attached to the HEV, it has to overcome the shear forces created by the blood flow. This is effected by the forces of attraction between the homing receptors and their ligands on the vessel wall that operates through microvilli on the leukocyte surface (Figure 6.14). After this tethering process, the lymphocyte rolls along the HEV, with L-selectin and other adhesion molecules on the lymphocyte binding to their ligands on the endothelium. The selectins generally terminate in a lectin domain (hence “selectin”), as might be expected given the oligosaccharide nature of the ligands.

Stage 2: LFA-1 activation resulting in firm adhesion

The process of tethering and rolling leads to the recruitment of the LFA-1 integrin to the nonvillous surface of the lymphocyte. This integrin undergoes structural activation in response to chemokine signals, resulting in very strong binding to ICAM-1 and -2 on the endothelial cell. The intimate contact causes the lymphocyte rolling to be arrested and a flattening of the lymphocyte.

Stage 3: Diapedesis

The flattened lymphocyte now uses the LFA-1 to additionally bind to junctional adhesion molecule-1 (JAM-1) on the endothelial cells in order to elbow its way between the endothelial cells and into the tissue in response to chemotactic signals.

Lymphocyte homing to other tissues

Homing of activated and memory lymphocytes to other tissues, such as the liver, involves a similar process but with different receptors and ligands involved (Figure 6.3). Dendritic cells from the appropriate tissue play an important role in selectively imprinting the correct address code during their activation of naive T-cells. Cells concerned in mucosal immunity are imprinted to enter Peyer's patches by binding to HEVs in this location. In other cases involving migration into normal and inflamed tissues, the lymphocytes bind to and cross nonspecialized flatter endothelia.

It is essential that once activated in secondary lymphoid tissues the lymphocytes of appropriate antigen specificity can rapidly be deployed to the site of the infection. The upregulated expression of the VLA-4 and LFA-1 integrins on these activated antigen-specific cells permits them to detect, respectively, the VCAM-1 and ICAM-1 cell adhesion molecules that become expressed on vascular endothelium in response to IL-1 production in inflamed tissues.

Lymph nodes

The encapsulated tissue of the lymph nodes acts as a filter for lymph draining the body tissues (Figure 6.15a). The lymph, which will contain any foreign antigens present in the tissues, enters the subcapsular sinus (space) via the afferent lymphatic vessels. The subcapsular sinus constitutes a continuous area beneath the capsule that surrounds the entire lymph node and, together with the trabecular sinuses which pass through the body of the lymph node, allow larger antigens to either be engulfed by the resident macrophages lining the subcapsular and medullary sinuses, or to pass unimpeded to the efferent lymphatics (Figure 6.12 and Figure 6.15b). The resident macrophages, together with dendritic cells that have taken up antigen in the tissues and arrive via the afferent lymphatics, can both act as APCs for T-cells in the lymph node.

Naive B-cells, irrespective of their antigen specificity, are able to use their complement receptors to transport immune complexes from the subcapsular sinus to specialized *follicular dendritic cells (FDCs)* for subsequent presentation to antigen-specific B-cells. The FDCs have very elongated processes that make intimate contact with B-lymphocytes. FDCs, unlike nearly all the other cells of the immune system, are not derived from bone marrow hematopoietic stem cells but instead arise from multipotent mesenchymal stem cells. They are functionally very clearly distinct from interdigitating dendritic cells, being nonphagocytic and lacking MHC class II and molecules required for T-cell co-stimulation such as CD80 and CD86.

Within the lymph node parenchyma there are extensive conduit networks composed of collagen fibers ensheathed by

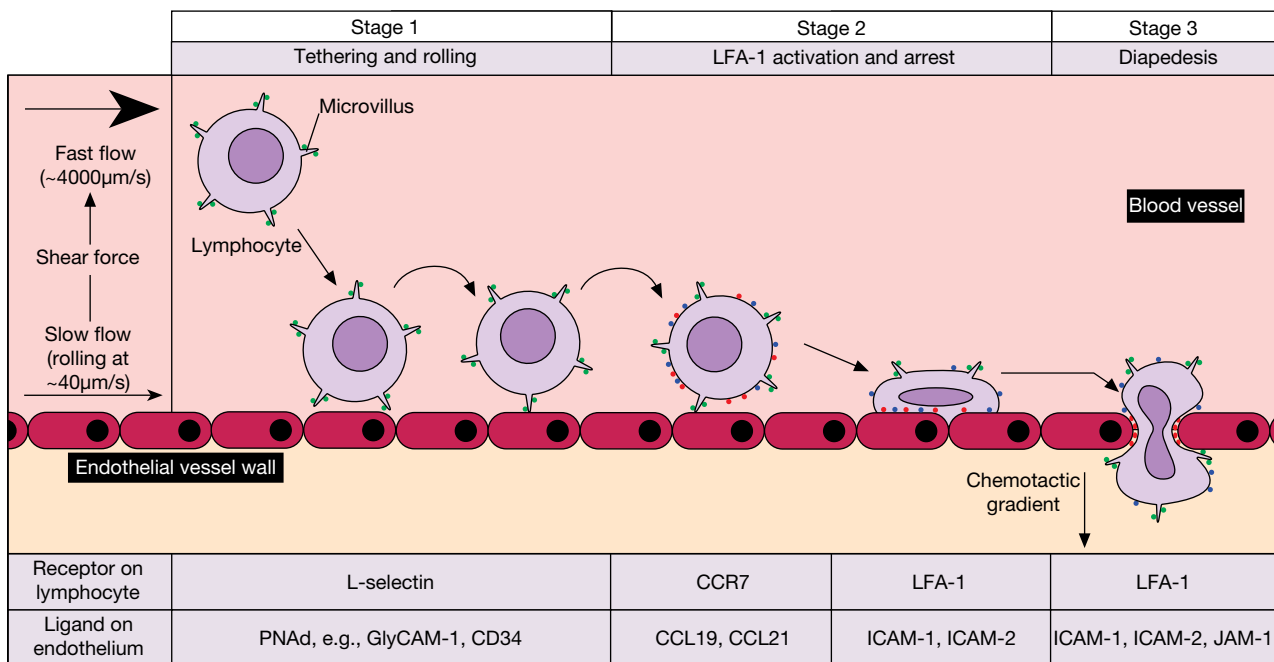


Figure 6.14 Homing and transmigration of lymphocytes into peripheral lymph nodes. Fast-moving lymphocytes are tethered (Stage 1) to the vessel walls of the tissue they are being guided to enter through an interaction between specific homing receptors, such as L-selectin (green dots) located on the microvilli of the lymphocyte, and its peripheral node addressin (PNAd) ligands on the vessel wall. PNAd comprises several molecules, including CD34 and GlyCAM-1, which possess fucosylated, sulfated and sialylated Lewis^x structures. Various chemokine receptors (red dots) are also present on these T- and B-cells. After rolling along the surface of the endothelial cells, activation of the lymphocyte LFA-1 integrin (blue dots) (see Table 6.1) occurs (Stage 2) in response to stimulation by chemokines. For T-cells this stage is mainly regulated by CCL19 and CCL21 binding to CCR7 as shown, whereas for B-cells CXCL13 binding to CXCR5 provides additional signals. Note that, because LFA-1 is absent from the microvilli, firm binding occurs by the body of the lymphocyte to its ligands, ICAM-1/2, on the endothelium. This process results in cell arrest and flattening followed by migration of the lymphocyte between adjacent endothelial cells, a process referred to as diapedesis (Stage 3), which involves LFA-1 binding not only to ICAM-1/2 but additionally to the junctional adhesion molecule-1 (JAM-1), which is present between the endothelial cells.

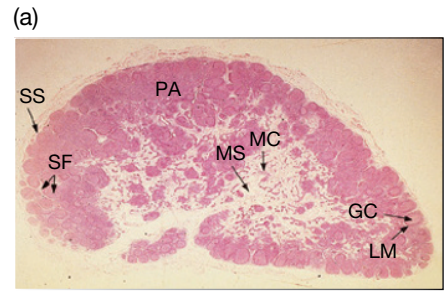
fibroblastic reticular cells (FRCs) to form 200 nm–3 μm diameter channels (Figure 6.15c). Lymph containing small antigens (below approximately 70 kDa), chemokines, and other low molecular weight substances passes through the channels of the conduit system to permeate the lymph node. Because the FRCs do not form a complete seal around the channels, both dendritic cells and lymphocytes are able to extend protuberances into the conduits, thereby both accessing the antigen-containing lymph and receiving chemokine signals. What is so striking about the organization of the lymph node is that the T- and B-lymphocytes are very largely separated into different anatomical compartments, a process directed to a large extent by chemokines. Lymph node stromal cells (and to a lesser extent interdigitating dendritic cells) secrete CCL19 and CCL21 in the paracortex that is deposited locally on the surface of the HEVs and FRCs, thereby attracting CCR7-bearing T-cells along a network of reticular fibers. In contrast, CXCL13 produced by

stromal cells in the cortex attracts CXCR5-positive B-cells, which can traffic along a network of FDC processes.

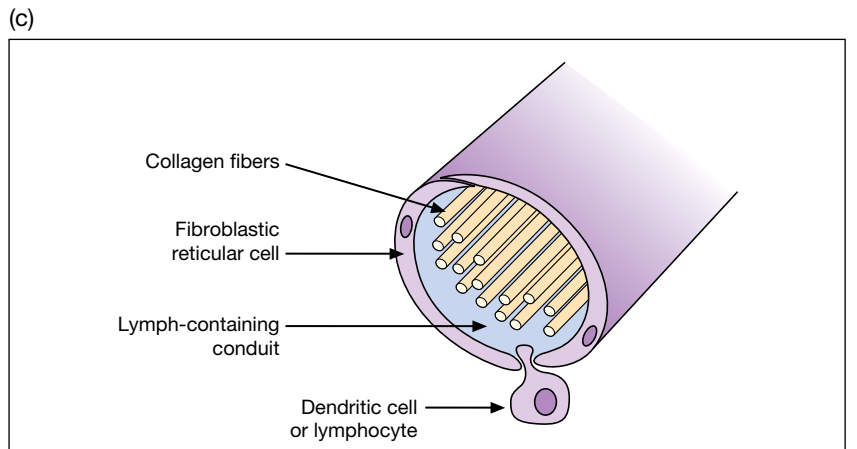
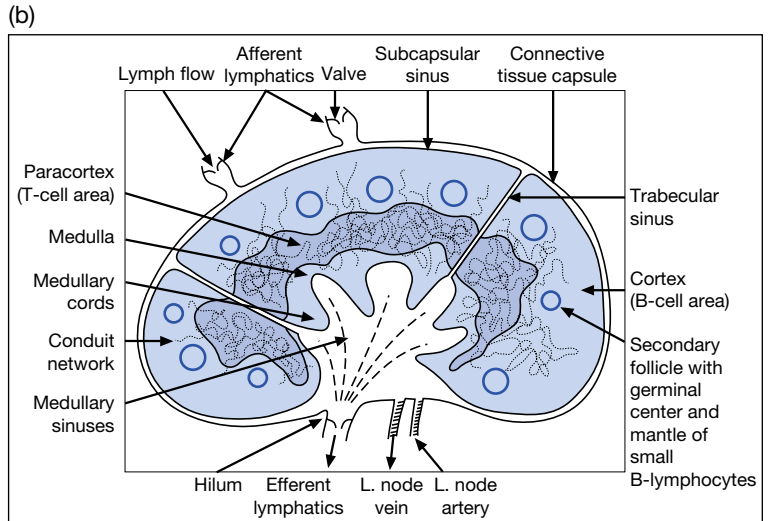
B-cell areas

The follicular aggregations of B-lymphocytes are a prominent feature of the outer cortex of the lymph node. In the unstimulated node they are present as spherical collections of cells termed *primary follicles*, but after antigenic challenge they form *secondary follicles* that consist of a corona or mantle of concentrically packed, resting, small IgM⁺ IgD⁺ B-cells surrounding a pale-staining *germinal center* (Figure 6.15d,e). This structure contains large, usually proliferating B-blasts (activated B-cells with increased amounts of cytoplasm), a minority of T-cells, scattered macrophages, and a network of FDCs. The formation of germinal centers is dependent upon B-cell expression of the Bcl-6 transcription factor which,

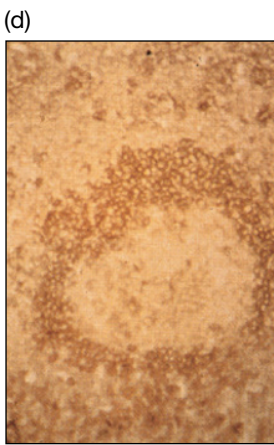
Figure 6.15 Lymph node. (a) Human lymph node, low-power view. GC, germinal center; LM, lymphocyte mantle; MC, medullary cords; MS, medullary sinus; PA, paracortex; SF, secondary follicles; SS, subcapsular sinus. (Source: P.M. Lydyard. Reproduced with permission.)



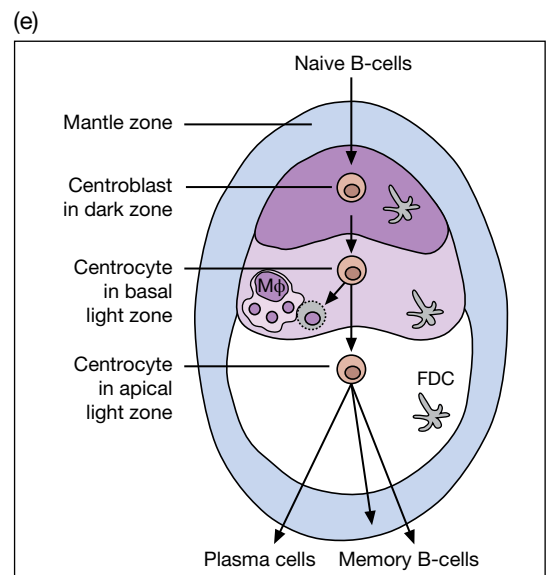
(b) Diagrammatic representation of section through a whole node. Each lymph node is served by several afferent lymphatic vessels but usually has only one efferent lymphatic vessel. (c) The conduit networks that permeate the lymph node parenchyma are composed of collagen bundles enclosed by fibroblastic reticular cells. The networks are filled with lymph and act to transport small antigens and chemokines to different areas of the lymph node. (d) Secondary lymphoid follicle showing germinal center surrounded by a mantle of small B-lymphocytes stained by anti-human IgD labeled with horseradish peroxidase (brown color). There are few IgD-positive cells in the center but both areas contain IgM-positive B-lymphocytes. (Source: K.A. MacLennan. Reproduced with permission.) (e) The differentiation of B-cells during passage through different regions of an active germinal center. Macrophages engulf apoptotic B-cells in the basal light zone. Plasma cell precursors leave the germinal center before reaching full maturity, whereas memory B-cells can either leave the germinal center or enter the mantle zone. FDC, follicular dendritic cell; Mφ, macrophage.



(d) Secondary lymphoid follicle showing germinal center surrounded by a mantle of small B-lymphocytes stained by anti-human IgD labeled with horseradish peroxidase (brown color). There are few IgD-positive cells in the center but both areas contain IgM-positive B-lymphocytes. (Source: K.A. MacLennan. Reproduced with permission.)



(e) The differentiation of B-cells during passage through different regions of an active germinal center. Macrophages engulf apoptotic B-cells in the basal light zone. Plasma cell precursors leave the germinal center before reaching full maturity, whereas memory B-cells can either leave the germinal center or enter the mantle zone. FDC, follicular dendritic cell; Mφ, macrophage.



among other roles, regulates B-cell activation and differentiation. Germinal centers constitute sites of B-cell proliferation, class switching, somatic hypermutation, and the generation of memory B-cells and the precursors of plasma cells.

On priming with a T-dependent antigen (i.e., antigen for which the B-cells require cooperation from T-helper cells), the FDC network within the germinal center becomes colonized by specific B-cells undergoing exponential growth. These proliferating cells form what is called the **dark zone** (because it stains more heavily with histological stains). This coloration is due to the dense packing of the lymphocytes with the production of around 10^4 B-cells that are referred to in this location as **centroblasts**. Recruitment of B-cells to the dark zone of the germinal center is dependent on the local production of the CXCL12 chemokine detected by CXCR4 on the B-cells. The centroblasts displace the original resting B-cells that now form the mantle that surrounds the germinal center. These highly mitotic centroblasts in the dark zone express high levels of CXCR4 and low levels of CD86. Differentiation into **centrocytes** involves transit into a less densely packed area of the germinal center called the **basal light zone**, which is where most of the FDCs are found. This differentiation is accompanied by downregulation of CXCR4 and upregulation of CD86. At this stage there is very extensive apoptotic cell death of B-cells with inappropriate specificity and/or affinity, giving rise to fragmented lymphocytes that are visible as phagocytosed “tingible bodies” within the macrophages, the disposal system for the dead cells. The higher affinity survivors undergo their final differentiation in the **apical light zone**. A proportion of those that differentiate down the **memory cell** pathway take up residence in the mantle zone; the remainder join the recirculating B-cell pool. Other germinal center B-cells in the apical light zone differentiate into a cell type called the **plasmablast** which has a well-defined endoplasmic reticulum, prominent Golgi apparatus, and cytoplasmic Ig. Plasmablasts migrate to become antibody-secreting **plasma cells** in the **medullary cords**, which project between the **medullary sinuses** (Figure 6.15b). This maturation of antibody-forming cells at a different location (i.e., in the medullary cords of the secondary follicles rather than in the germinal center itself) from that at which antigen triggering has occurred is also seen in the spleen, where plasma cells are found predominantly in the marginal zone. It is thought that this movement of cells acts to prevent the generation of high local concentrations of antibody within the germinal center, so avoiding neutralization of the antigen and premature shut-down of the immune response. We will look at germinal centers again in Chapter 8.

The remainder of the outer cortex is also essentially a B-cell area with scattered T-cells.

T-cell areas

T-cells are mainly confined to the paracortex of the lymph node (Figure 6.15a,b). Techniques such as intravital multiphoton scanning laser microscopy allow observation of lymphocyte behavior within lymphoid tissue. T-cells are seen to move rapidly and randomly within the paracortex, where they attempt to find an interdigitating dendritic cell (IDC) bearing “their” antigen. Should the TCR on the T-cell recognize the cognate MHC-peptide, a stable binding occurs that is largely cemented by LFA-1 on the T-cell binding to ICAM-1 on the IDC. An immunological synapse is generated and contact maintained for 8–24 hours in order to fully activate the T-cell. As germinal centers develop, newly activated helper T-cells can enter these structures to develop into T-follicular helper (T_{fh}) cells. These T-cells have upregulated their expression of the Bcl-6 transcription factor leading to decreased CCR7 and increased CXCR5 chemokine receptor levels. They also have high levels of the CD28 family members PD-1 and ICOS, and secrete cytokines such as IL-4 and IL-21 that direct the differentiation of germinal center B-cells.

Spleen

The spleen is divided into the **white pulp**, which includes the **periarteriolar lymphoid sheaths (PALS)** and functions as a secondary lymphoid tissue, and the macrophage-rich **red pulp**, which is responsible for the removal by phagocytosis of aging erythrocytes, platelets, and some blood-borne pathogens. The white pulp constitutes circular or elongated areas (Figure 6.16a) within the erythrocyte-containing red pulp, which possesses blood-filled venous sinusoids (channels) lined with macrophages. As in the lymph node, the T- and B-cell areas of the white pulp are segregated (Figure 6.16b). In addition to acting as a very effective blood filter removing effete (old or damaged) cells, the spleen is also important in generating immune responses against any infectious agents present in the blood. Plasmablasts and mature plasma cells are present in the area referred to as the **marginal zone** extending into the red pulp (Figure 6.16c).

Bone marrow is a major site of antibody synthesis

Although B-cells mature in the bone marrow from hematopoietic stem cells, upon maturation most naive B-cells leave for the secondary lymphoid tissues where they can encounter antigen. This release from the bone marrow may be regulated by sphingosine 1-phosphate, which is known to control the exit of lymphocytes from the thymus and lymph nodes. Activated B-cells can recirculate back to the bone marrow



and cluster around vascular sinusoids. In this location they are able to partake in the generation of antibody responses to blood-borne pathogens and their survival is maintained by bone marrow dendritic cells secreting the cytokine MIF (macrophage migration inhibitory factor). The bone marrow is known to be the major residence of long-lived plasma cells (Figure 6.17), the precursors of which are generated in the germinal centers of secondary lymphoid tissues. Thus, the bone marrow is a major source of serum Ig. Both B and T memory cells are also present.

The liver contains a variety of immune system cells

The liver is supplied with both venous blood from the intestine and arterial blood, and therefore is well placed to monitor circulating antigens. It plays an important role in innate responses, including the production of acute phase proteins and many of the complement components. Together with the spleen, it is the main location to which immune complexes are transported for their subsequent destruction. In the case of the liver this is carried out by Kupffer cells – the resident macrophages of this organ. A relatively high proportion of NK and NKT cells is present, and CD1d on dendritic cells is able to present microbial glycolipids to liver NKT cells. The human liver also contains large numbers of conventional T-cells that can be activated locally by a variety of APCs, including interdigitating dendritic cells, Kupffer cells, and liver sinusoidal endothelial cells. Nonetheless, the liver tends to be a rather tolerogenic environment owing to the presence of high levels of IL-10 and PD-L1 (programmed death-1 ligand-1) and therefore the threshold for T-cell activation is set rather high.

Immunologically privileged sites

Certain locations in the body, including the brain, anterior chamber of the eye, and testis, are referred to as *immunologically privileged sites* because antigens located within them do not provoke an immune response. For example, foreign corneal grafts are not rejected, and a number of viruses have been expanded by repeated passage through animal brain.

In general, privileged sites are protected by blood–tissue barriers and low permeability to hydrophilic compounds. Functionally insignificant levels of complement reduce the threat of acute inflammatory reactions and unusually high concentrations of immunosuppressive cytokines, such as IL-10 and TGF β , quash any unruly Th1-lymphocyte activity. Immune privilege can also be maintained by Fas (CD95)-induced apoptosis of autoaggressive cells. The immunologist

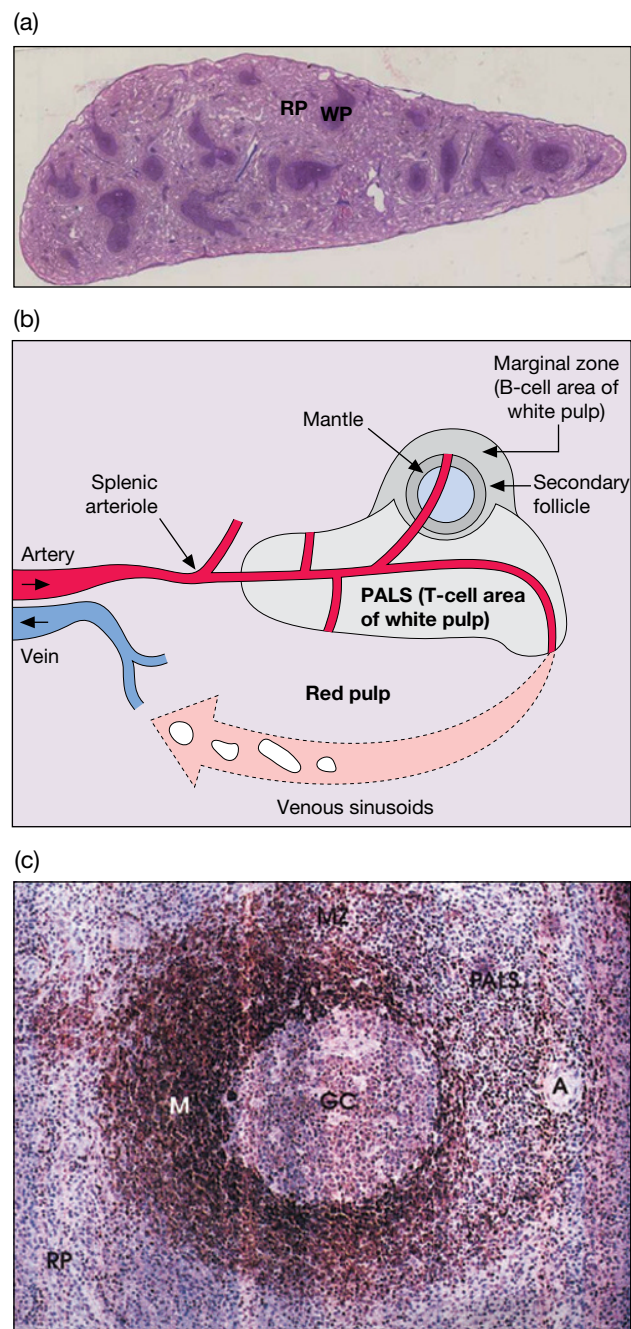


Figure 6.16 Spleen. (a) Low-power view of human spleen showing red pulp (RP) and lymphoid white pulp (WP). Mallory's triple stain. (Source: Image courtesy of G. Campbell.) (b) Diagrammatic representation of an area of white pulp surrounded by red pulp. (c) High-power view of germinal center (GC) and lymphocyte mantle (M) surrounded by marginal zone (MZ) and red pulp (RP). Adjacent to the follicle, an arteriole (A) is surrounded by the periarteriolar lymphoid sheath (PALS) predominantly consisting of T-cells. Note that the marginal zone is present only above the secondary follicle. (Source: I.C.M. MacLennan. Reproduced with permission.)

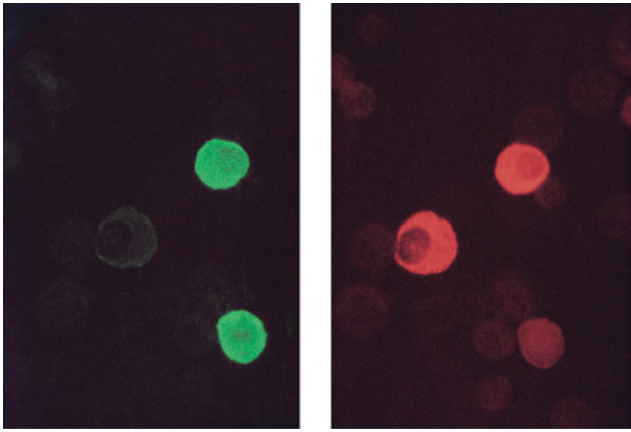


Figure 6.17 Plasma cells in human bone marrow. Cytospin preparation stained with rhodamine (orange) for IgA heavy chain and fluorescein (green) for lambda light chain. Both images are of the same field, one showing the green fluorescence, the other the orange fluorescence. Thus, one cell is IgA.λ, another IgA.non-λ and the third is non-IgA.λ positive. (Source: R. Benner, W. Hijmans, and J.J. Haaijman. Reproduced with permission.)

Lesley Brent put it rather well: “It may be supposed that it is beneficial to the organism not to turn the anterior chamber or the cornea of the eye, or the brain, into an inflammatory battlefield, for the immunological response is sometimes more damaging than the antigen insult that provoked it.”

The handling of antigen

Where does antigen go when it enters the body? If it penetrates the tissues, it will be carried by the lymph to the draining lymph nodes. Antigens that are encountered in the upper respiratory tract, intestine, or reproductive tract are dealt with by the local MALT, whereas antigens in the blood provoke a reaction in the spleen.

Macrophages are general antigen-presenting cells

Antigens draining into lymphoid tissue are taken up by macrophages. The antigens are then partially, if not completely, broken down in the phagolysosomes; some may escape from the cell in a soluble form to be taken up by other APCs such as dendritic cells, and a fraction may reappear at the surface as a processed peptide associated with MHC class II. Although

resting resident macrophages express very little if any MHC class II, antigens are usually encountered in the context of a microbial infectious agent that can activate the macrophage to express class II following engagement of pattern recognition receptors, such as TLR4 by bacterial lipopolysaccharide (LPS). Macrophages are also induced to express MHC class II following exposure to IFN γ or engagement of CD35 (complement receptor 1).

Interdigitating dendritic cells present antigen to naive T-lymphocytes

Notwithstanding the impressive ability of the mighty macrophage to present antigen, there is one function where it is deficient, namely the priming of naive T-lymphocytes. This is the role of the interdigitating dendritic cell (IDC), the *crème de la crème* of the APCs. Precursors in the blood enter the tissues and differentiate into dendritic cells with phagocytic and endocytic activity. These are sometimes described in the literature as immature dendritic cells but the reality is that they are fully able at this stage to carry out the functions required of them, primarily antigen detection and uptake. These cells include the Langerhans cells in the epidermis of the skin. Receptors involved in antigen capture, including the mannose receptor, various TLRs, and Fc receptors for both IgG and IgE, are present on these dendritic cells. The expression of cell surface MHC class II, and of adhesion and co-stimulatory molecules, is low at this early stage of the dendritic cells' life. However, as they differentiate into fully fledged APCs, they decrease their phagocytic and endocytic activity, show reduced levels of molecules involved in antigen capture, but dramatically increase their MHC class II. Co-stimulatory molecules, such as CD40, CD80 (B7.1), and CD86 (B7.2), are also upregulated. Their expression of a number of chemokine receptors, including CCR7, CCR8, and CXCR4 (see Table 8.2) means that they are attracted to and migrate into T-cell areas in lymphoid tissue.

Two separate developmental pathways for IDCs have been described: the myeloid pathway, which generates CD11c⁺ interstitial **myeloid dendritic cells** and skin Langerhans cells, and the lymphoid pathway, which produces **plasmacytoid dendritic cells** that lack or express only very low levels of CD11 and can produce large amounts of interferon- α and - β . There appear to be a number of subpopulations of myeloid dendritic cells, although this area is still somewhat shaky.

In the absence of activation, dendritic cells lack expression of co-stimulatory molecules such as CD80 and CD86. Antigen presented by these “tolerogenic” dendritic cells will

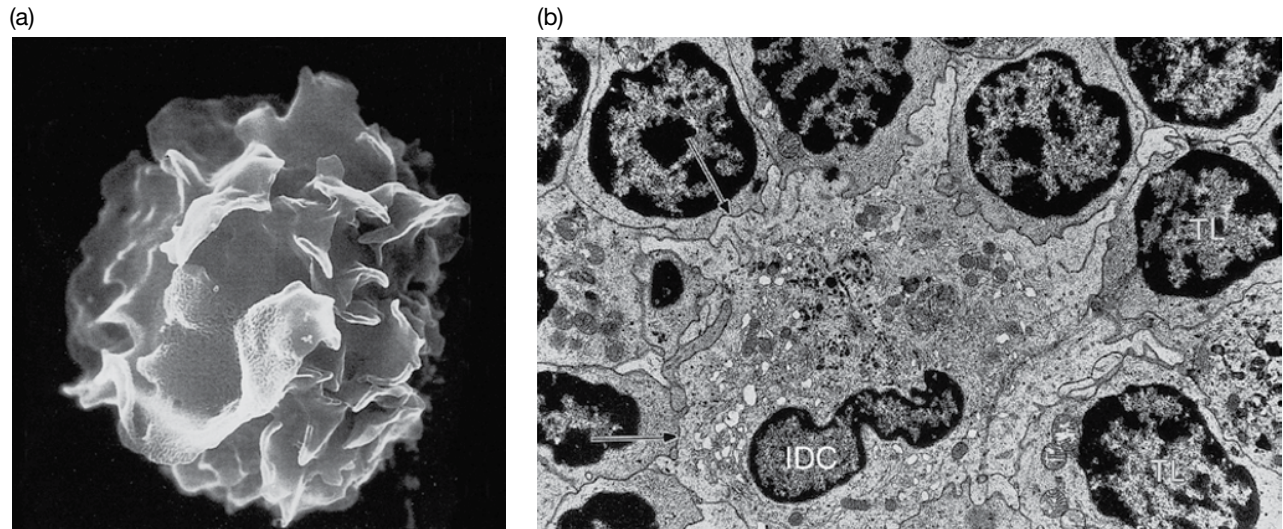


Figure 6.18 Interdigitating dendritic cells (IDCs). (a) Scanning electron micrograph of a veiled cell, the morphological form adopted by IDCs as they travel in the afferent lymph. (Source: Image courtesy of G.G. MacPherson.) (b) IDC in the thymus-dependent area of the rat lymph node. Intimate contacts are made with the surface membranes (arrows) of the surrounding T-lymphocytes (TL) ($\times 2000$). In contrast to these IDCs that present processed antigen to T-cells, the follicular dendritic cells in germinal centers present intact antigen to B-cells. (Source: Kamperdijk E.W.A. *et al.* (1980) In Van Furth R. (ed.) *Mononuclear Phagocytes*, 3rd edn. Rijhoff Publishers, The Hague. Reproduced with permission of Rijhoff Publishers.)

cause T-cell anergy or deletion owing to a lack of co-stimulation, or will induce regulatory T-cells to secrete immunosuppressive cytokines such as IL-10 and TGF β . Indeed, the dendritic cells themselves are also able to secrete these cytokines. In some circumstances dendritic cells can also exhibit a regulatory phenotype by secreting indoleamine 2,3-dioxygenase (IDO), which catalyzes the depletion of tryptophan, in the absence of which T-cells undergo apoptosis.

The scenario for T-cell priming appears to be as follows. Dendritic cells pick up and process antigen. As differentiation in response to pattern recognition receptor stimulation proceeds, they downregulate the adhesion molecule E-cadherin, upregulate certain chemokine receptors including CCR7 (which detects CCL19 and CCL21 expressed by the endothelium in peripheral lymph nodes), and produce matrix metalloproteinases to facilitate their migration. They then travel as “veiled” cells in the lymph (Figure 6.18a) before settling down as IDCs in the paracortical T-cell zone of the draining node (Figure 6.18b). There the IDC delivers the processed protein antigen in the form of peptide–MHC together with co-stimulatory signals (Figure 6.19) for potent

stimulation of naive, and subsequently of activated, specific T-cells. We will meet IDCs again in Chapter 10 when we discuss their central role within the thymus in presenting self peptides to developing autoreactive T-cells and triggering their apoptotic execution (known more gently as “clonal deletion”).

Follicular dendritic cells bind immune complexes and stimulate B-cells

The immunoglobulin receptors Fc γ RIIB and Fc ϵ RII, together with the complement receptors CR1 (CD35) and CR2 (CD21), on the surface of the nonphagocytic MHC class II-negative *follicular dendritic cells* (FDCs) enables these cells to bind immune complexes of antigen–antibody–complement very efficiently. Memory B-cells can then be stimulated by recognition of the antigen, and co-stimulated through the B-cell CD21 recognizing complement fragments on the surface of the FDC. Intact antigens can be retained as immune complexes on FDCs for many months or possibly even longer.

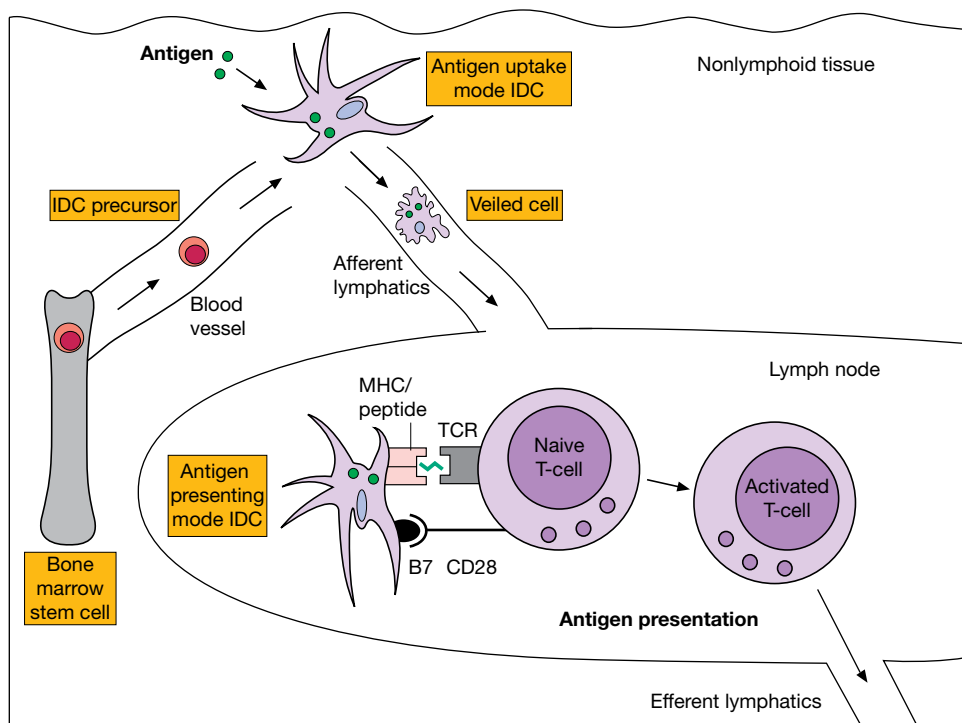


Figure 6.19 Migration of interdigitating dendritic cells (IDCs). The precursors of the IDCs are derived from bone marrow stem cells. They travel via the blood to nonlymphoid tissues. At this stage in their life these IDCs (e.g., Langerhans cells in skin) are specialized for antigen uptake. Subsequently they travel via the afferent lymphatics as veiled cells (see Figure 6.18a) to take up residence within secondary lymphoid tissues (see Figure 6.18b) where they express high levels of MHC class II and co-stimulatory molecules such as B7 (CD80 and CD86). These cells are highly specialized for the activation of naive T-cells. The activated T-cell may carry out its function in the lymph node or, after imprinting with relevant homing molecules, recirculate to the appropriate tissue.

SUMMARY

Location

- The immune system includes cells that are highly motile and able to travel around the body in the blood and lymphatic circulation.
- This motility greatly enhances the chance of an encounter with the pathogen.
- The vast majority of cell types most closely involved in immune defense are generated from multipotent hematopoietic stem cells in the bone marrow.
- Regarding lymphocytes, B-cells develop directly in the bone marrow whereas the precursors of T-cells must first travel to the thymus before developing into functional mature T-cells. The bone marrow and thymus are therefore referred to as the primary lymphoid tissues.
- Adaptive immune responses are initiated in the secondary lymphoid tissues: the mucosa-associated lymphoid tissue (MALT), lymph nodes, and spleen.

Skin

- Commensal organisms and the physical and chemical barrier afforded by the skin are important defenses against infection.

- T-cells of both the $\alpha\beta$ and $\gamma\delta$ subsets are present in the epidermis and the dermis.
- The T-cells in the skin characteristically bear cutaneous lymphocyte antigen (CLA) and the chemokine receptor CCR4.
- Approximately 10% of skin T-cells express Foxp3, indicating that they may have a regulatory function.
- Langerhans cells in the epidermis and dermal dendritic cells are closely related but may serve different functions.

Mucosal immunity

- Respiratory, gastrointestinal, and sexually transmitted infections at mucosal surfaces are dealt with by diffuse collections of T- and B-cells and by the organized MALT.
- The Peyer's patches are the location where immune responses in the gut are induced.
- Specialized antigen-transporting M-cells in the gut sample antigens and pass them to the underlying antigen-presenting cells and lymphocytes.
- The highly vascularized lamina propria beneath the epithelial surface contains activated T-cells and secretory IgA-producing plasma cells.

- LPAM-1⁺ ($\alpha_4\beta_7$ -integrin) T-cells are directed to the intestinal lamina propria due to the expression of MAdCAM-1 on the postcapillary venules at this location.
- Intraepithelial lymphocytes are mostly T-cells and include CD8 $\alpha\alpha$ -bearing cells that recognize antigens presented by nonclassical MHC molecules.

Leukocyte circulation

- Leukocytes can circulate in the blood in order to reach the lymphoid tissues or enter the site of an infection.
- Immune system cells, particularly lymphocytes and dendritic cells, also travel around the lymphatic system which joins up with the blood circulation via the thoracic duct and the right lymphatic duct.

Lymphocyte homing

- Lymphocyte recirculation between the blood and lymph nodes is guided by specialized homing molecules on the surface of the high-walled endothelium of the postcapillary venules (HEV).
- Homing molecules function as vascular addressins and are recognized by the LFA-1 integrin, by L-selectin, and by CCR7 on the lymphocyte.
- The peripheral lymph node addressins (PNAd) comprise Lewis^x oligosaccharides on certain glycoproteins, including GlyCAM-1 and CD34.
- Peripheral lymph node HEVs display the chemokines CCL19 and CCL21, which are recognized by CCR7 on both lymphocytes and dendritic cells.
- Passage through the HEV occurs in three stages: (1) tethering and rolling, (2) LFA-1 activation, and (3) diapedesis.
- Sphingosine 1-phosphate (S1P) signals for lymphocytes to leave lymph nodes.

Lymph nodes and spleen

- Lymph nodes filter and screen lymph flowing from the body tissues; the spleen filters the blood.
- B- and T-cell areas are separated under the direction of chemokines.
- Lymph nodes contain conduit networks that permit the distribution of small antigens and chemokines throughout

the node and are composed of collagen fibers surrounded by fibroblastic reticular cells.

- B-cell structures appear in the lymph node cortex as primary follicles that become secondary follicles with germinal centers after antigen stimulation.
- The germinal center consists of a dark zone, basal light zone, and apical light zone and is surrounded by a mantle of resting B-cells.
- Germinal centers with their meshwork of follicular dendritic cells expand B-cells and direct their differentiation into memory cells and the precursors of antibody-secreting plasma cells.
- The spleen is composed of red pulp and white pulp, the latter including the periarteriolar lymphoid sheaths (PALS).

Other sites

- Bone marrow is a major site of antibody production.
- The liver contains substantial numbers of lymphocytes and phagocytic cells.
- The brain, anterior chamber of the eye, and testis are privileged sites in which antigens are safely sequestered.

The handling of antigen

- Macrophages are general antigen-presenting cells for primed lymphocytes but cannot stimulate naive T-cells.
- This is effected by dendritic cells that process antigen, migrate to the draining lymph node, and settle down as MHC class II-positive professional antigen-presenting cells.
- These interdigitating dendritic cells possess high levels of co-stimulatory molecules such as CD80 and CD86, which enables them to activate naive T-cells.
- Dendritic cells are derived by both the myeloid and lymphoid pathways of hematopoietic stem cell differentiation.
- In the absence of stimulation dendritic cells lack CD80 and CD86 and are tolerogenic.
- An entirely different type of cell, the follicular dendritic cell (FDC), is derived from multipotent mesenchymal stem cells and resides in germinal centers where it displays immune complexes in order to activate B-cells.



Now visit www.roitt.com to test yourself on this chapter.

FURTHER READING

- Barclay A.N., Birkeland M.L., Brown M.H., *et al.* (1997) *The Leukocyte Antigen Facts Book*, 2nd edn. Academic Press, London.
- Bos J.D. (ed.) (2004) *Skin Immune System (SIS): Cutaneous Immunology and Clinical Immunodermatology*, 3rd edn. CRC Press, Boca Raton, FL.
- Crispe N. (2009) The liver as a lymphoid organ. *Annual Review of Immunology* **27**, 147–163.
- Gonzalez S.F., Degn S.E., Pitcher L.A., Woodruff M., Heesters B., and Carroll M.C. (2011) Trafficking of B cell antigen in lymph nodes. *Annual Review of Immunology* **29**, 215–233.

- Heath W.R. and Carbone F.R. (2013) The skin-resident and migratory immune system in steady state and memory: innate lymphocytes, dendritic cells and T cells. *Nature Immunology* **14**, 978–985.
- Hu W. and Pasare C. (2013) Location, location, location: tissue-specific regulation of immune responses. *Journal of Leukocyte Biology* **94**, 409–421.
- Masopust D. and Schenkel J.M. (2013) The integration of T cell migration, differentiation and function. *Nature Reviews Immunology* **13**, 309–320.
- Mueller S.N., Gebhardt, T., Carbone, F.R., and Heath W.R. (2013) Memory T cell subsets, migration patterns, and tissue residence. *Annual Review of Immunology* **31**, 137–161.
- Ramiscal R.R. and Vinuesa C.G. (2013) T-cell subsets in the germinal center. *Immunological Reviews* **252**, 146–155.
- Simpson E. (2006) A historical perspective on immunological privilege. *Immunological Reviews* **213**, 12–22.
- Victoria G.D. and Nussenzweig M.C. (2012) Germinal centers. *Annual Review of Immunology* **30**, 429–457.

CHAPTER 7

Lymphocyte activation

Key topics

- Clustering of membrane receptors frequently leads to their activation 188
- T-lymphocytes and antigen-presenting cells interact through several pairs of accessory molecules 189
- The activation of T-cells requires two signals 191
- Triggering the T-cell receptor complex 191
- Protein tyrosine phosphorylation is an early event in T-cell signaling 192
- Downstream events following TCR signaling 192
- CD28 co-stimulation amplifies TCR signals and blocks apoptosis 195
- Activated T-cells exhibit distinct gene expression signatures 196
- Epigenetic control of T-cell activation 199
- Activated T-cells undergo an essential metabolic shift 200
- Metabolic control of T-cell differentiation 202
- Damping T-cell enthusiasm 203
- Dynamic interactions at the immunological synapse 205
- B-cells respond to three different types of antigen 207
- The nature of B-cell activation 210
- Dynamic interactions at the BCR synapse 214

Roitt's Essential Immunology, Thirteenth Edition. Peter J. Delves, Seamus J. Martin, Dennis R. Burton, and Ivan M. Roitt.
© 2017 John Wiley & Sons, Ltd. Published 2017 by John Wiley & Sons, Ltd.
Companion website: www.roitt.com

Just to recap ...

T- and B-lymphocytes are the key effectors of adaptive immunity, using randomly generated membrane receptors to “see” antigen. In both cases, recognition of cognate antigen results in clonal expansion of the lymphocyte, which increases the numbers of cells available to mount a response and ensures that subsequent encounter with the same antigen will be met with greater force from the outset (i.e., immunological memory). Although B-cell receptors (surface IgM and IgD) can directly interact with antigen, T-cells require antigen to be presented in the context of MHC molecules. Antigen presentation to naive (i.e., not previously stimulated) T-cells takes place in lymphoid tissues and is typically carried out by mature dendritic cells (DCs) that have migrated from peripheral tissues because of exposure to a maturation stimulus, such as a pathogen-derived molecular pattern (PAMP). Mature DCs present processed antigens to T-cells by displaying peptides derived from such antigens on MHC molecules. DCs also provide essential co-stimulation to T-cells in the form of B7 family ligands (CD80/CD86) and other surface molecules; the absence of co-stimulatory molecules on the DC does not productively activate the T-cell and may lead to tolerization or death of a responding T-cell. B-cell activation also occurs within lymph nodes and other lymphoid tissues and is facilitated by specialized follicular dendritic cells that efficiently capture and concentrate antigen draining from surrounding tissues. With some exceptions, activated B-cells also require co-stimulation from T-helper cells, in the form of cytokines as well as membrane-bound CD40 ligand, to permit proliferation and differentiation. In addition to clonal expansion, activation of a B- or T-cell also results in maturation to specialized effector cells that produce antibodies (in the case of B-cells), or particular combinations of cytokines or cytotoxic molecules (in the case of T-cells).

Introduction

The adaptive immune response is initiated upon an encounter between a B- or T-lymphocyte and its specific antigen and ideally results in “activation” of the lymphocyte and a radical shift in cell behavior – from a slumbering nondividing state, to a more active proliferative one that is endowed with the ability to make lots of new proteins that contribute to immunity. This simultaneously achieves two goals: the number of cells that are capable of responding to a particular antigen are hugely multiplied via clonal expansion, and these new recruits are equipped with the ability to produce large quantities of cytokines or antibodies to help repel the intruder. However, there is a very important consideration to be taken into account before a lymphocyte encounter with antigen can be allowed to proceed to a full-blown immune response. Because of the potential dangers associated with inappropriate lymphocyte activation (to “self” or innocuous substances), signals that promote T- or B-cell activation usually require co-stimulation by other cells of the immune system. Indeed, the initiation of

an adaptive immune response is effectively conditional on presentation of the antigen by cells of the innate immune system (especially DCs) that have encountered clear and unequivocal evidence of infection in the form of pathogen-associated molecular patterns (PAMPs). Thus, cells of the innate immune system that have encountered PAMPs effectively give permission (in the form of co-stimulation) to lymphocytes of the adaptive immune system to respond to antigen presented in the appropriate context. The requirement for co-stimulation raises the threshold for lymphocyte activation and provides a very important safeguard against autoimmunity (see Chapter 17). Encounters with specific antigen in the absence of the proper co-stimulatory signals frequently results in death of the responding lymphocyte by apoptosis.

In previous chapters we learned that B- or T-cells use related, but nonetheless distinct, antigen receptors to recognize antigen. Stimulation of T- or B-cells through their respective antigen receptors initiates a cascade of *signal transduction events* within the responding lymphocyte that rely heavily upon *protein kinases*, proteins that can add phosphate groups to other proteins. Such phosphate groups, although puny in the overall context of the protein to which they are attached, either radically alter the activity of the target protein (in a positive or negative way), or create binding sites for other proteins to dock onto. In this way, activation of particular kinases acts as a switch to alter protein behavior. Ultimately, most of these signaling events culminate in the activation of multiple transcription factors that switch on new batteries of genes and permit the responding lymphocyte to make cytokines or antibodies at a prodigious rate. Thus, membrane receptors for antigen simply serve as the external switches for signals that permit T- and B-lymphocytes to be called into service at the appropriate time. Much of the complexity of T- and B-cell receptor signaling revolves around the issue of whether the switch should be turned on or not (i.e., when to respond or not).

Although there are differences in the nature of the specific kinases that relay signals from the B- and T-cell receptors, there are also many similarities. In both cases, these signal transduction events result in the activation of many of the same transcription factors, entry into the cell division cycle, and the expression of an array of new proteins by the activated lymphocyte that equips such cells with functions characteristic of effector cells.

Clustering of membrane receptors frequently leads to their activation

All cells use plasma membrane-borne receptors to extract information from their environment. This information is propagated within the cell by signaling molecules and enables the cell to make the appropriate response; whether this is reorganization of the cell cytoskeleton (to facilitate movement), expression of new gene products, increased cellular adhesiveness, or all of the above. In many instances, occupation of the receptor with its specific

ligand (whether this is a growth factor, a hormone, or an antigen) results in conformational or other changes within the receptor that promotes recruitment of cytoplasmic adaptor proteins to the portion of the receptor exposed to the cytoplasm. Because many plasma membrane receptors are protein kinases, or can recruit protein kinases upon engagement with their specific ligands, stimulation of such receptors typically results in phosphorylation of regions within the receptor in contact with the cytoplasm (i.e., the cytoplasmic tail) or of associated proteins.

In the case of the B- and T-cell receptors (BCR and TCR), the receptors themselves do not have any intrinsic enzymatic activity but are associated with invariant accessory molecules (the CD3 $\gamma\delta\epsilon$ and ζ chains in the case of the TCR, and the Ig- $\alpha\beta$ complex in the case of the BCR) that can attract the attentions of a particular class of kinases. Central to this attraction is the presence of special motifs called *ITAMs* (*immunoreceptor tyrosine-based activation motifs*) within the cytoplasmic tails of these accessory molecules (see also Chapter 4). Phosphorylation of ITAMs at tyrosine residues – in response to TCR or BCR stimulation – enables these motifs to interact with adaptor proteins that have an affinity for phosphorylated tyrosine motifs, thereby initiating signal transduction. We will deal, in turn, with the signaling events that take place upon encounter of a T-cell or a B-cell with antigen.

T-lymphocytes and antigen-presenting cells interact through several pairs of accessory molecules

Before we delve into the nuts and bolts of TCR-driven signaling events, it is important to recall that T-cells can only recognize antigen when presented within the peptide-binding groove of major histocompatibility complex (MHC) molecules. Furthermore, while the TCR is the primary means by which T-cells interact with the MHC-peptide complex, T-cells also express co-receptors for MHC (either CD4 or CD8) that define functional T-cell subsets. Recall that CD4 molecules act as co-receptors for MHC class II and are found on T-helper cell populations that provide “help” for activation and maturation of B-cells and cytotoxic T-cells (Figure 7.1). CD8 molecules act as co-receptors for MHC class I molecules and are a feature of cytotoxic T-cells that can kill virally infected or precancerous cells (Figure 7.1). Note, however, that the affinity of an individual TCR for its specific MHC-antigen peptide complex is relatively low (Figure 7.2). Thus, a sufficiently stable association with an antigen-presenting cell (APC) can only be achieved by the interaction of several complementary pairs of accessory molecules such as LFA-1/ICAM-1, CD2/LFA-3, and so on (Figure 7.3). These adhesion molecules enable T-cells to associate with DCs and other APCs for the purposes of inspecting the peptides being presented within MHC molecules (Figure 7.4). However, these molecular couplings are not necessarily concerned with intercellular adhesion alone; some of these interactions also provide the necessary co-stimulation that is essential for proper lymphocyte activation.

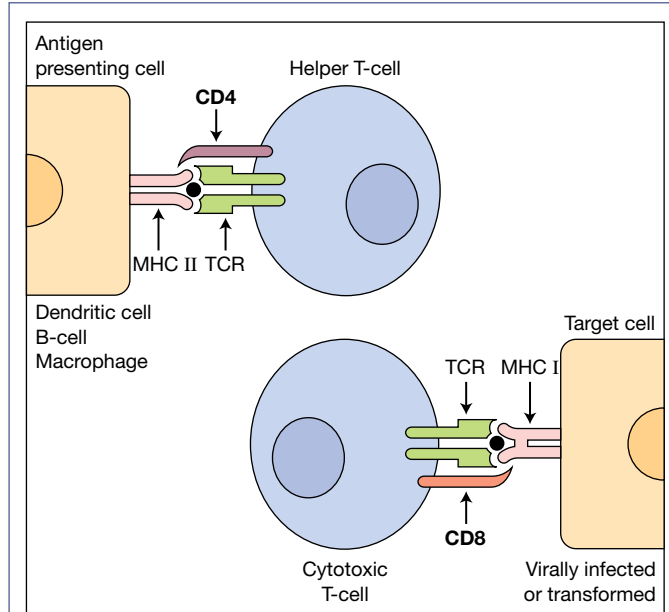


Figure 7.1 Helper and cytotoxic T-cell subsets are restricted by MHC class. CD4 on helper T-cells acts as a co-receptor for MHC class II and helps to stabilize the interaction between the TCR and peptide-MHC complex; CD8 on cytotoxic T-cells performs a similar function by associating with MHC class I.

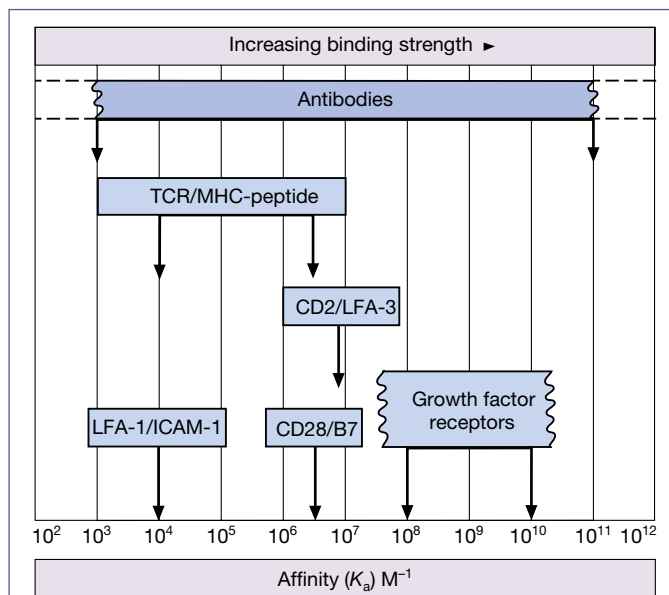


Figure 7.2 The relative affinities of molecular pairs involved in interactions between T-lymphocytes and cells presenting antigen. The ranges of affinities for growth factors and their receptors, and of antibodies, are shown for comparison. (Adapted from Davies M.M. and Chien Y.-H. (1993) *Current Opinion in Immunology* 5, 45. Reproduced with permission of Elsevier.)

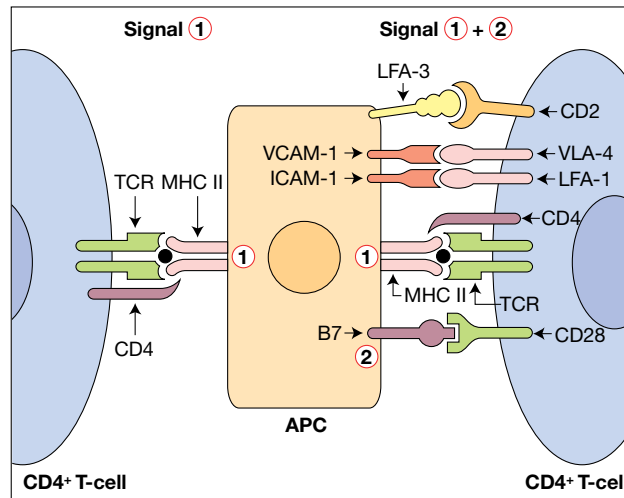


Figure 7.3 Activation of resting T-cells. Interaction of co-stimulatory molecules leads to activation of resting T-lymphocyte by antigen-presenting cell (APC) on engagement of the T-cell receptor (TCR) with its antigen–MHC complex. Engagement of the TCR signal 1 without accompanying co-stimulatory signal 2 leads to anergy. Note, a cytotoxic rather than a helper T-cell would, of course, involve coupling of CD8 to MHC class I. Signal 2 is delivered to a resting T-cell primarily through engagement of CD28 on the T-cell by B7.1 or B7.2 on the APC. ICAM-1, intercellular adhesion molecule-1; LFA-1, lymphocyte function-associated molecule-1; VCAM-1, vascular cell adhesion molecule-1; VLA-4, very late antigen-4.

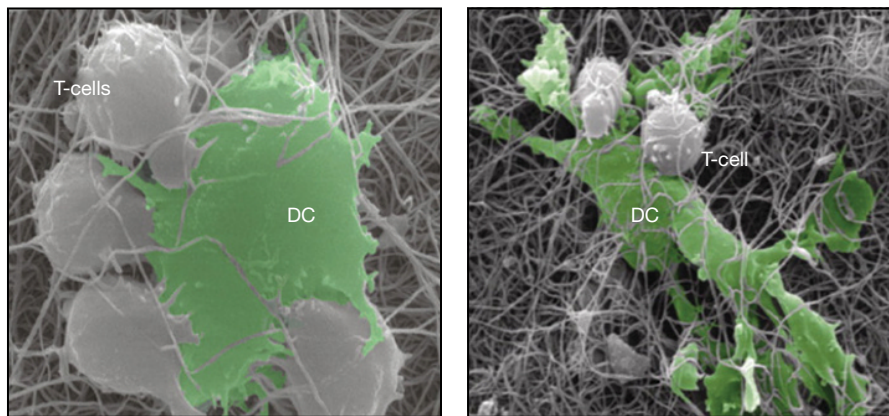


Figure 7.4 Interaction between T-cells and dendritic cells. Scanning electron microscopy analysis of DC–T-cell interactions within a 3-D collagen matrix. (Source: Gunzer M. *et al.* (2004) *Blood* **104**, 2801–2809. Reproduced with permission of American Society of Hematology.)

Unstimulated lymphocytes are typically nonadherent but rapidly adhere to extracellular matrix components or other cells (such as APCs) within seconds of encountering chemokines or antigen. Integrins such as LFA-1 and VLA-4 appear to be particularly important for lymphocyte adhesion. The ease with which lymphocytes can alter their adhesiveness seems to be related to the ability of integrins to change conformation; from a closed, low-affinity state to a more open, high-affinity one (Figure 7.5). Thus, upon encounter of a T-cell with an APC displaying an appropriate MHC–peptide complex, signals

routed through the TCR complex ensure that the affinity of LFA-1 for ICAM-1 is rapidly increased and this helps to stabilize the interaction between the T-cell and the APC. This complex has come to be known as the *immunological synapse*. Activation of the small GTPase *Rap1* by TCR stimulation appears to contribute to the rapid change in integrin adhesiveness. How *Rap1* achieves this remains somewhat uncertain, but it is likely that modification of the integrin cytoplasmic tail serves to trigger a conformational change within the integrin extracellular domains in a process that has been termed “inside-out” signaling.

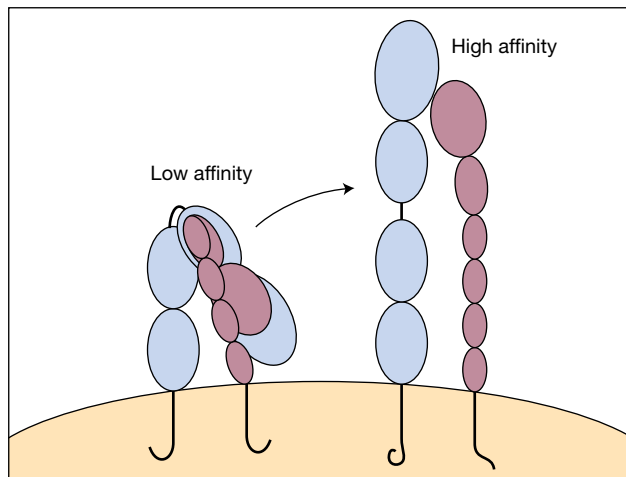


Figure 7.5 Integrin activation. Integrins such as LFA-1 can assume different conformations that are associated with different affinities. The bent head-piece conformation has a low affinity for ligand but can be rapidly transformed into the extended high-affinity conformation by activation signals that act on the cytoplasmic tails of the integrin α and β subunits; a process known as “inside-out” signaling.

The activation of T-cells requires two signals

Stimulation of the TCR by MHC–peptide (which can be mimicked by antibodies directed against the TCR or CD3 complex) is not sufficient to fully activate resting helper T-cells on their own. Upon co-stimulation via the CD28 receptor on the T-cell, however, RNA and protein synthesis is induced, the cell enlarges to a blast-like appearance, interleukin-2 (IL-2) synthesis begins and the cell moves from G0 into the G1 phase of the cell division cycle. Thus, **two signals** are required for the activation of a naive helper T-cell (Figure 7.3).

Antigen in association with MHC class II on the surface of a mature DC is clearly capable of fulfilling the requirement for both signals. Complex formation between the **TCR and MHC–peptide provides signal 1**, through the receptor–CD3 complex, and this is greatly enhanced by coupling of CD4 with the MHC. The T-cell is now exposed to a **co-stimulatory signal (signal 2)** from the mature DC. The most potent co-stimulatory molecules are the **B7 family ligands** (CD80/CD86) on the DC that interact with CD28 on the T-cell, although other molecules (such as IL-1 and ligands for ICOS, CD2, and OX40) can also serve in this capacity.

Recall from Chapter 1 that immature DCs, that have not been exposed to PAMPs or DAMPs (danger-associated molecular patterns) are incapable of productively activating T-cells. This is due to the relative absence of co-stimulatory molecules such as CD80/CD86 on the surface of immature DCs. However, a profound increase in the expression of these molecules occurs as a result of maturation of the DC

subsequent to stimulation of its pattern recognition receptors with a PAMP or a DAMP. Inflammatory cytokines (such as IL-1, GM-CSF, and TNF α) that are produced by macrophages and neutrophils in the initial stages of infection are also capable of converting immature, poorly co-stimulating DCs into mature DCs capable of providing the necessary signals. Activation of resting T-cells can be blocked by anti-B7, which renders the T-cell **anergic** (i.e., unresponsive to any further stimulation by antigen). As we shall see in later chapters, the principle that two signals activate but one may induce anergy in an antigen-specific cell provides a potential for targeted immunosuppressive therapy. However, unlike resting T-lymphocytes, **activated T-cells proliferate in response to a single signal**.

Adhesion molecules such as ICAM-1, VCAM-1, and LFA-3 are not intrinsically co-stimulatory but greatly augment the effect of other signals by up to 100-fold (Figure 7.3); this is an important distinction. Early signaling events also involve the aggregation of **lipid rafts** composed of membrane subdomains enriched in cholesterol and glycosphingolipids. The cell membrane molecules involved in activation become concentrated within these structures.

Triggering the T-cell receptor complex

Let us now consider a situation in which a T-cell has encountered a DC displaying the correct peptide–MHC combination and has engaged with the DC such that many of the TCRs on the T-cell are engaged with a similar number of high-affinity peptide–MHC molecules on the APC. Such an event will greatly stabilize the interaction between the T-cell and the DC such that the duration of the encounter (the dwell time) will be sufficient to activate the T-cell (Figure 7.4). But what is the actual activating event? Put another way, how does the TCR complex register that the switch has been thrown?

Despite much investigation, we still do not have a clear answer to this question but it appears that both aggregation of the TCR complex, as well as conformational changes within the complex, play key roles in signal initiation. Recall from Chapter 4 that the T-cell receptor complex is composed of the TCR itself and the **CD3 co-receptor complex**. The CD3 co-receptor complex contains CD3 $\gamma\delta\epsilon\zeta$, which possess the signaling motifs (ITAMs) necessary for propagation of signals into the cell (Figure 7.6). Recent evidence suggests that in a resting T-cell the cytoplasmic tails of the CD3 ϵ and CD3 ζ molecules are buried in the inner leaflet of the plasma membrane, which shields their ITAMs from the kinase, called Lck (which we will discuss in the next section), that is needed to get the signal transduction cascade going. Stable MHC–TCR interactions appear to be able to release the CD3 ϵ and CD3 ζ tails from the membrane, making them accessible to phosphorylation. As we shall shortly discuss, the signaling cascades that result from TCR stimulation can become quite complex (Figure 7.7); but take it one step at a time and a sense of order can be extracted from the apparent chaos.

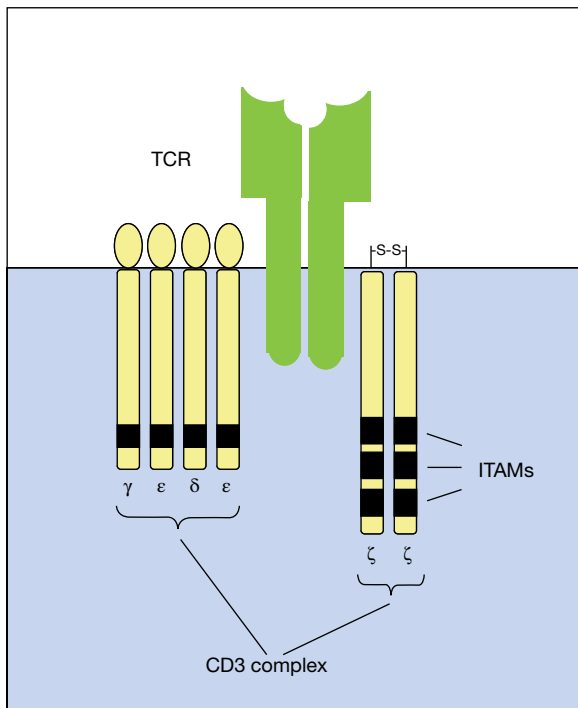


Figure 7.6 The CD3 co-receptor complex. The TCR has no intrinsic signaling activity but signals through the associated CD3 complex. Note that the CD3 complex is thought to comprise one subunit each of CD3 γ and δ , two CD3 ϵ subunits, and two disulfide-linked CD3 ζ (zeta) subunits. As depicted in the figure, all of the CD3 co-receptor subunits contain immunoreceptor tyrosine-based activation motifs (ITAMs) that can become phosphorylated by kinases activated upon TCR stimulation. Phosphorylation at such motifs creates binding sites for additional signaling molecules that can propagate T-cell activation signals.

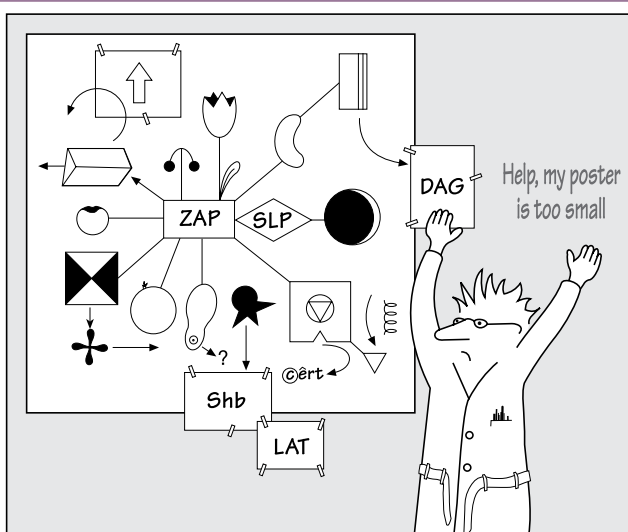


Figure 7.7 Signaling pathways can become quite complex. (Source: Zolnierowicz S. and Bollen M. (2000) *EMBO Journal* 19, 483. Reproduced with permission of Wiley.)

Protein tyrosine phosphorylation is an early event in T-cell signaling

Interaction between the TCR and MHC–peptide complex is greatly enhanced by recruitment of either co-receptor for MHC (CD4 or CD8) into the complex. Furthermore, because the cytoplasmic tails of CD4 and CD8 are constitutively associated with *Lck*, a protein tyrosine kinase (PTK) that can phosphorylate the three tandemly arranged ITAMs within the TCR ζ chains, recruitment of CD4 or CD8 to the complex results in stable association between *Lck* and its ζ -chain substrate (Figure 7.8a).

Phosphorylation of ζ chain by *Lck* creates binding sites for the recruitment of another PTK, *ZAP-70* (zeta chain-associated protein of 70 kDa), into the TCR signaling complex (Figure 7.9). Recruitment of *ZAP-70* into the receptor complex results in activation of this PTK by *Lck*-mediated phosphorylation. *ZAP-70*, in turn, phosphorylates two key adaptor proteins, *LAT* (linker for activation of T-cells) and *SLP-76* (SH2-domain containing leukocyte protein of 76 kDa) that can instigate divergent signaling cascades downstream (Figure 7.8b).

LAT plays an especially significant role in subsequent events by serving as a platform for the recruitment of several additional players to the TCR complex. *LAT* contains many tyrosine residues that, upon phosphorylation by *ZAP-70*, can bind to other adaptor proteins through motifs (called SH2 domains) that bind phosphotyrosine residues. Thus, phosphorylation of *LAT* results in recruitment of *GADS* (*GRB2-related adaptor protein*) that is constitutively associated with *SLP-76*. *SLP-76* has been implicated in cytoskeletal rearrangements owing to its ability to associate with *Vav1* and *NCK*. Thus, TCR stimulation-induced cell shape changes are most likely because of recruitment of *SLP-76* into the TCR signaling complex.

Phosphorylated *LAT* also attracts the attentions of two additional phosphotyrosine-binding proteins; the $\gamma 1$ isoform of *phospholipase C* (*PLC $\gamma 1$*), and the adaptor protein *GRB2* (*growth factor receptor-binding protein 2*). From this point on, at least two distinct signaling cascades can ensue: the *Ras–MAP kinase pathway* and the *phosphatidylinositol pathway* (Figure 7.8c).

Downstream events following TCR signaling

The Ras–MAP kinase pathway

Ras is a small G-protein that is constitutively associated with the plasma membrane and is frequently activated in response to diverse stimuli that promote cell division (Figure 7.10). It can exist in two states: GTP-bound (active) and GDP-bound (inactive). Thus, exchange of GDP for GTP stimulates Ras activation and enables this protein to recruit one of its downstream effectors, *Raf*. So how does TCR stimulation result in activation of Ras? One of the ways in which Ras activation can

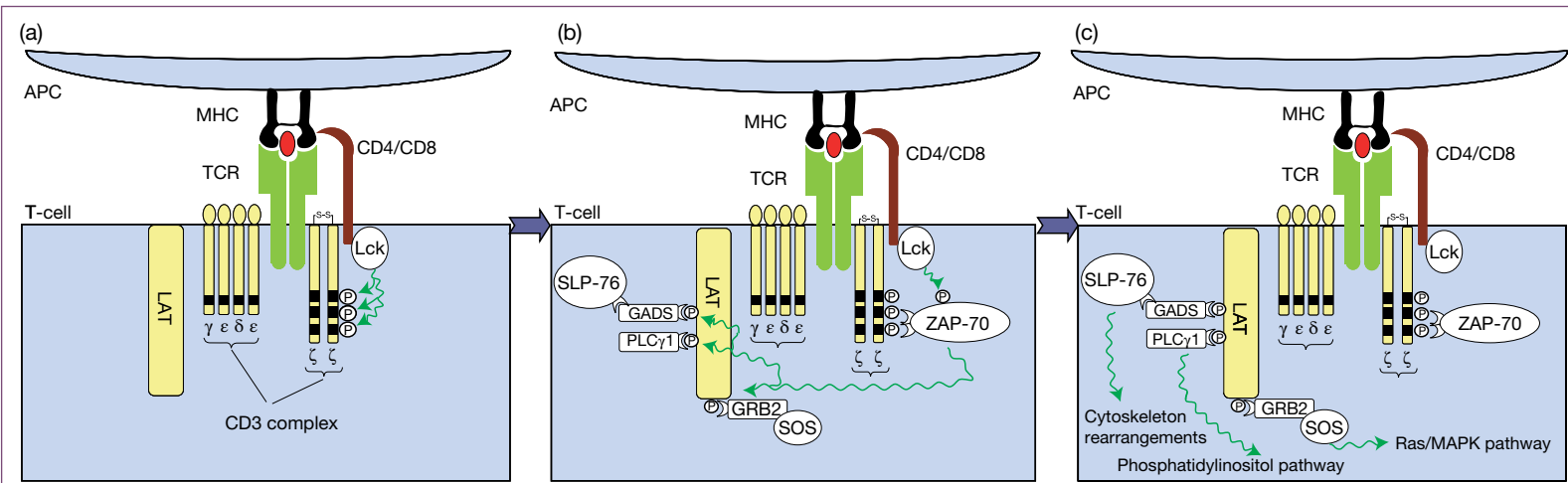


Figure 7.8 Signaling events downstream of T-cell receptor (TCR) engagement. (a) Engagement of the TCR with the correct peptide–MHC combination leads to CD4/CD8 recruitment to the TCR complex through interactions with MHC on the antigen-presenting cell (APC) (note that, for simplicity, co-stimulation between B7 and CD28 is not depicted). Because CD4 and CD8 are constitutively associated with the Lck kinase, this brings Lck into close proximity to the ITAMs within the CD3 co-receptor complex. Lck then phosphorylates CD3 ζ on multiple sites, that creates binding sites for recruitment of the ZAP-70 kinase. (b) ZAP-70 recruitment to the CD3 co-receptor complex leads to its phosphorylation and activation by Lck. Active ZAP-70 then propagates TCR signals through phosphorylation of LAT at several sites. Phosphorylated LAT serves as a platform for recruitment of multiple signaling complexes, as depicted. (c) Molecules recruited to LAT instigate three main signaling cascades, as depicted, which cooperatively achieve T-cell activation. See main text for further details.

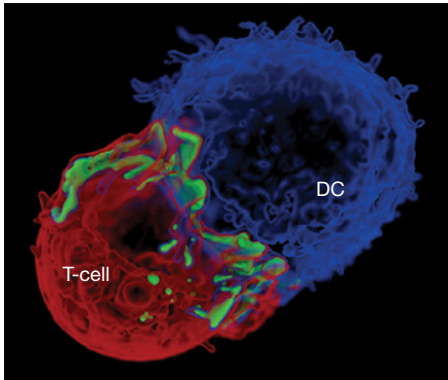


Figure 7.9 Interaction between T-cell and DC. Upon interaction with a DC, T-cell signaling occurs by the recruitment of ZAP-70 (green) to the interface between the two cells. (Source: James R.J. and Vale, R.D. (2012) *Nature* **487**, 64–69. Reproduced with permission of Nature Publishing Group.)

be achieved is through the activity of *GEFs* (*guanine-nucleotide exchange factors*) that promote exchange of GDP for GTP on Ras. One such GEF, SOS (son of sevenless), is recruited to phosphorylated LAT via the phosphotyrosine-binding protein GRB2 (Figure 7.8). Thus, phosphorylation of LAT by ZAP-70 leads directly to the recruitment of the GRB2/SOS complex to the plasma membrane where it can stimulate activation of Ras through promoting exchange of GDP for GTP.

In its GTP-bound state, Ras can recruit a kinase, *Raf* (also called *MAPKKK*, *mitogen-associated protein kinase kinase kinase*!), to the plasma membrane that then sets in motion a series of further kinase activation events culminating in phosphorylation of the transcription factor Elk1, in addition to many other transcription factors. Elk1 phosphorylation permits translocation of this protein to the nucleus and results in the expression of Fos, yet another transcription factor. The appearance of Fos results in the formation of heterodimers with Jun to form the AP-1 complex that has binding sites on the IL-2 promoter as well as on many other genes (Figure 7.11). Deletion of AP-1 binding sites from the IL-2 promoter abrogates 90% of IL-2 enhancer activity.

The phosphatidylinositol pathway

Phosphorylation of LAT by ZAP-70 not only promotes docking of the GRB2/SOS complex on LAT, but also stimulates recruitment of the $\gamma 1$ isoform of *phospholipase C* (*PLC γ 1*) (Figure 7.8b). PLC γ 1 plays a crucial role in propagating the cascade further. Phosphorylation of PLC γ 1 activates this lipase thereby enabling it to hydrolyze the membrane phospholipid *phosphatidylinositol bisphosphate* (*PIP $_2$*) into diacylglycerol (DAG) and inositol trisphosphate (*IP $_3$*) (Figure 7.11). Interaction of *IP $_3$* with specific receptors in the endoplasmic reticulum triggers the release of Ca^{2+} into the cytosol that also triggers an influx of extracellular calcium (Figure 7.12). The

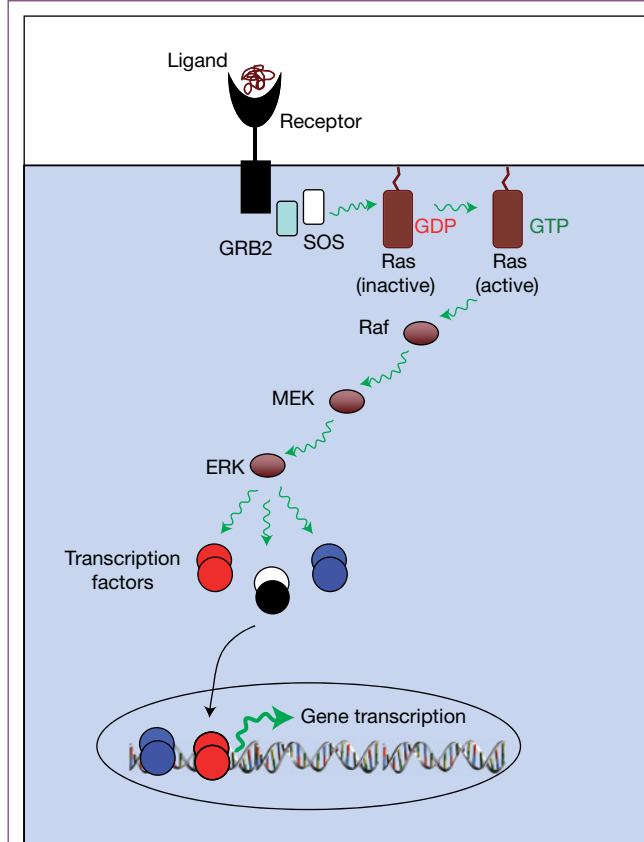


Figure 7.10 The Ras–MAP kinase pathway. Regulation of Ras activity controls kinase amplification cascades. A number of cell surface receptors signal through Ras-regulated pathways. Ras cycles between inactive Ras–GDP and active Ras–GTP, regulated by guanine nucleotide exchange factors (GEFs) that promote the conversion of Ras–GDP to Ras–GTP, and by GTPase-activating proteins (GAPs) that increase the intrinsic GTPase activity of Ras. Upon ligand binding to receptor, receptor tyrosine kinases recruit adaptor proteins (e.g., Grb2) and GEF proteins, such as Sos (“son of sevenless”), to the plasma membrane. These events generate Ras–GTP, which can now recruit the Raf kinase (also known as mitogen activated protein kinase, MAPK) to the plasma membrane, where it becomes activated by another membrane-associated kinase. Activation of Raf then leads to a cascade of further kinase activation events downstream, culminating in the activation of a battery of transcription factors, including Elk1. The Ras–MAPK cascade is frequently invoked by growth factors and other stimuli that trigger proliferation.

raised Ca^{2+} concentration within the T-cell has at least two consequences. First, it synergizes with DAG to activate *protein kinase C* (*PKC*); second, it acts together with *calmodulin* to increase the activity of *calcineurin*, a protein phosphatase that can promote activation of an important transcription factor (NFAT) required for IL-2 production.

The Ca^{2+} -dependent activation of PKC by DAG is instrumental in the activation of yet another transcription factor, NF κ B. NF κ B is actually a family of related transcription

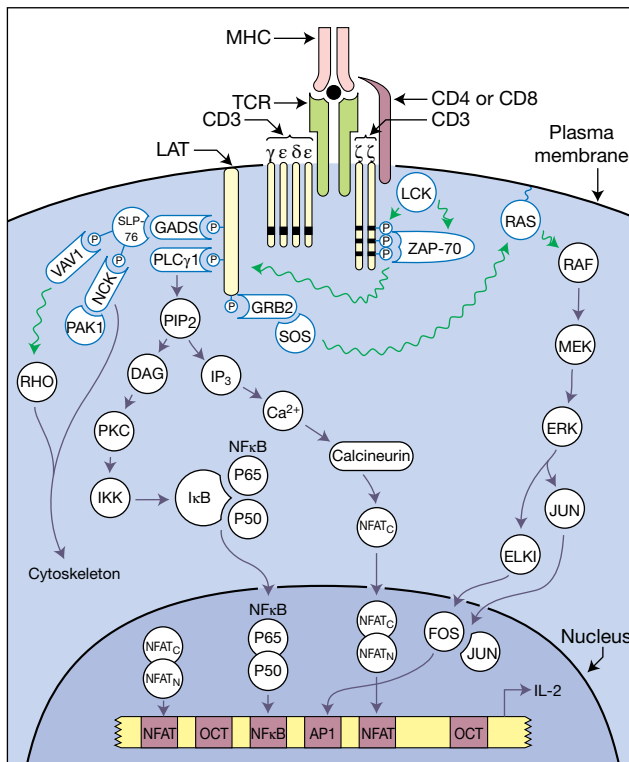


Figure 7.11 Overview of TCR-based signaling. Signals through the MHC–antigen complex (signal 1) and B7 molecules (signal 2) initiate a cascade of protein kinase activation events and a rise in intracellular calcium, thereby activating transcription factors that control entry in the cell cycle from G0 and regulate the expression of IL-2 and many other cytokines. Stable recruitment of CD4 or CD8 to the TCR complex initiates the signal transduction cascade through phosphorylation of the tandemly arranged ITAM motifs within the CD3 ζ chains, which creates binding sites for the ZAP-70 kinase. Subsequent events are marshaled through ZAP-70-mediated phosphorylation of LAT; recruitment of several signaling complexes to LAT results in triggering of the Ras–MAPK and PLC γ 1 signaling pathways. The latter pathways culminate in activation of a range of transcription factors including NF κ B, NFAT, and Fos/Jun heterodimers. Note that other molecules can also contribute to this pathway but have been omitted for clarity. See main body of text for further details. DAG, diacylglycerol; ERK, extracellular signal regulated kinase; IP $_3$, inositol trisphosphate; LAT, linker for activated T-cells; NF κ B, nuclear factor κ B; NFAT, nuclear factor of activated T-cells; OCT-1, octamer-binding factor; Pak1, p21-activated kinase; PIP $_2$, phosphatidylinositol diphosphate; PKC, protein kinase C; PLC, phospholipase C; SH2, Src-homology domain 2; SLP-76, SH2-domain containing leukocyte-specific 76 kDa phosphoprotein; ZAP-70, ζ chain-associated protein kinase.

factors that are involved in the regulation of transcription of many genes, including cytokines (such as IL-2), as well as genes that can promote cell survival by blocking signals that promote apoptosis.

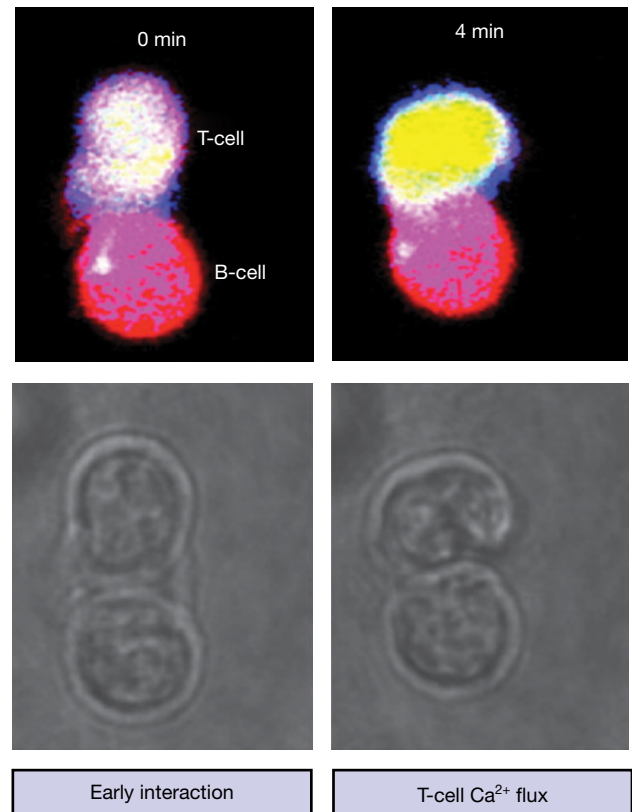


Figure 7.12 An activated T-cell undergoes calcium flux. A T-cell receives a calcium signal (yellow glow) upon cognate interaction with a naive B-cell. (Source: Gunzer M. *et al.* (2004) *Blood* **104**, 2801–2809. Reproduced with permission of the American Society of Hematology.)

CD28 co-stimulation amplifies TCR signals and blocks apoptosis

As we have frequently noted, naive T-cells typically require two signals for proper activation: one derived from TCR ligation (signal 1) and the other provided by simultaneous engagement of CD28 on the T-cell (signal 2) by CD80 (B7.1) or CD86 (B7.2) on the DC (Figure 7.3). Indeed, T-cells derived from CD28-deficient mice, or cells treated with anti-CD28 blocking antibodies, display severely reduced capacity to proliferate in response to TCR stimulation *in vitro* and *in vivo*. Moreover, CD28 deficiency also impairs T-cell differentiation and the production of cytokines required for B-cell help. Similar effects are also seen when CD80 or CD86 expression is interfered with. So what does tickling the CD28 receptor do that is so special?

Well, the simple answer is that we do not really know what kind of signal CD28 co-stimulation produces that is radically different from the signals produced upon stimulation of the TCR complex, as several of the same signaling pathways are triggered. CD28 is expressed on the plasma membrane of naive as well as activated T-cells as a 44 kDa homo-dimer, the

cytoplasmic domain of which lacks any intrinsic enzyme activity. The cytoplasmic tail of CD28 does, however, contain tyrosine-based motifs that, upon phosphorylation at these residues, recruit *phosphatidylinositol 3-kinase (PI3K)* and *Grb2*. Thus, upon CD28 cross-linking, signals are propagated via PI3K that can impact upon multiple signaling pathways, including cell survival, cell metabolism, and protein synthesis.

CD28-mediated activation of PI3K is important for the suppression of apoptosis, which appears to be achieved via the downstream target of this pathway, the PkB/Akt kinase. The latter kinase regulates transcription factors that result in increased expression of the anti-apoptotic Bcl-x_L protein. By upregulating Bcl-x_L, CD28 stimulation blocks TCR-mediated signals that would otherwise result in apoptosis (a process called *activation-induced cell death (AICD)*) (see Videoclip 2). PI3K has also been implicated in phosphorylating I κ k, which in turn can phosphorylate PLC γ , which, as we discussed earlier, has an important role in IP₃ generation downstream of TCR stimulation. Thus, PI3K activation via CD20 co-stimulation may synergize with the TCR to promote PLC γ activation.

Grb2 docks onto the same motif within the cytoplasmic tail of CD28 as PI3K and can activate the Ras pathway via its associated guanine-nucleotide exchange factor SOS, as discussed earlier.

Although early studies suggested that CD28 stimulation might result in *qualitatively* different signals to those that are generated through the TCR, many studies suggest that this might not be the case. Instead, these studies suggest that while CD28 engagement might activate pathways within the T-cell that TCR stimulation alone does not, the primary purpose of co-stimulation through CD28 may be to *quantitatively* amplify or stabilize signals through the TCR by converging on similar transcription factors such as NF κ B and NFAT, which are critical for IL-2 production. In support of this view, microarray analyses of genes upregulated in response to TCR ligation alone, versus TCR ligation in the presence of CD28 co-stimulation, found, rather surprisingly, that essentially the same cohorts of genes were expressed in both cases. Although signals through CD28 enhanced the expression of many of the genes switched on in response to TCR ligation, no new genes were expressed. This indicates that CD28 co-stimulation may be required in order to cross signaling thresholds that are not achievable via TCR ligation alone. One is reminded here of the choke that earlier generations of cars were supplied with to provide a slightly more fuel-rich mixture to help start a cold engine. CD28 co-stimulation of naive T-cells may serve a similar purpose, with the CD28 “choke” no longer needed when these cells have warmed up as a result of previous stimulation.

The requirement for two signals for T-cell activation is a very good way of minimizing the likelihood that T-cells will respond to self antigens. Because T-cell receptors are generated randomly and can, in principle, recognize almost any short peptide, the immune system needs a way of letting a T-cell know that particular (i.e., nonself) peptides should be

responded to whereas others (i.e., derived from self) should not. The fact that CD80/CD86 molecules are only upregulated on APCs that have been stimulated with a PAMP provides quite a clever way of ensuring that only APCs that have encountered microorganisms are able to properly present peptides to T-cells. Once again, we see the guiding hand of the innate immune system helping to qualify what represents “danger” and what does not. So, let us now turn to the issue of what happens downstream of a successful T-cell activation event.

Activated T-cells exhibit distinct gene expression signatures

Because there are a multitude of infectious agents, running the gamut from viruses, intracellular bacteria, large parasitic worms, extracellular bacteria, yeast, and other fungi, the reader will not be too surprised to learn that *activated T-cells become specialized* towards dealing with the particular class of infectious agent that caused them to be woken from their slumber. This process, called *T-cell polarization*, will be dealt with more fully in Chapter 8, but we will introduce it here because it is inextricably linked to T-cell activation. Because of the diversity of intra- and extracellular pathogens, activated T-cells must *differentiate into distinct types of effector T-cells*, specifically tailored to tackle a particular class of invader. As we have mentioned in previous chapters, activated T-cells can undergo differentiation into at least three distinct subclasses: T-helper (Th) cells, cytotoxic T-cells (CTLs), and regulatory T-cells (Treg). CD4⁺ T-cells coordinate immune responses by differentiating into distinct *T-helper subsets* that tailor the immune response towards the particular infectious agent. T-helper cells achieve this by releasing powerful *inflammatory cytokines*, which direct the subsequent responses of CD8⁺ T-cells, B-lymphocytes, and cells of the innate immune system such as macrophages. Recent studies have suggested that during the clonal expansion phase, the differentiation process starts as early as the second cell doubling, and in this context, activation and differentiation can be viewed as two halves of the same coin. Cumulatively, T-cell activation and differentiation promotes the upregulation of a myriad of genes and we will now consider the most important of these (Figure 7.13).

Integrated signals from the TCR, co-receptors, and cytokines promote distinct gene expression programs

The classical type 1 response to infection with intracellular pathogens is driven by *CD4⁺ Th1 cells*, which secrete IFN γ to direct the activation of CD8⁺ CTLs and phagocytic cells, such as macrophages (Figure 7.14). *CD4⁺ Th2* cells secrete IL-4, IL-5, and IL-13 to activate the B-cell-mediated antibody response against multicellular parasites such as helminths, while *CD4⁺ Th17* cells secrete IL-17, required for effective neutrophil and B-cell-driven immune responses against fungi and extracellular bacteria. Coordination of a particular T-cell immune response is directed by signals from the TCR/CD28



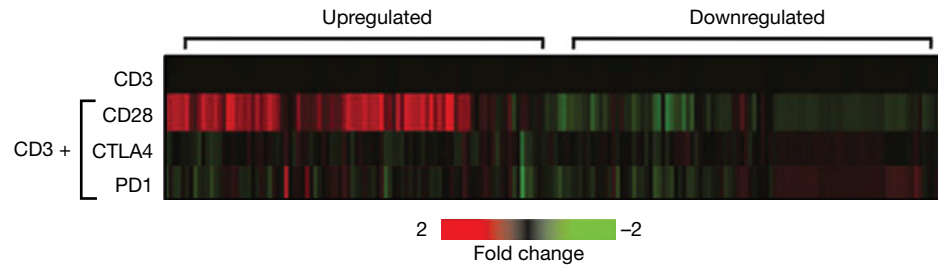


Figure 7.13 Gene expression analysis in T-cells after TCR/co-receptor engagement. CD4⁺ splenocytes were stimulated with anti-CD3 alone or together with antibodies specific for various co-stimulatory receptors. The heat map indicates fold change over CD3 stimulation alone.

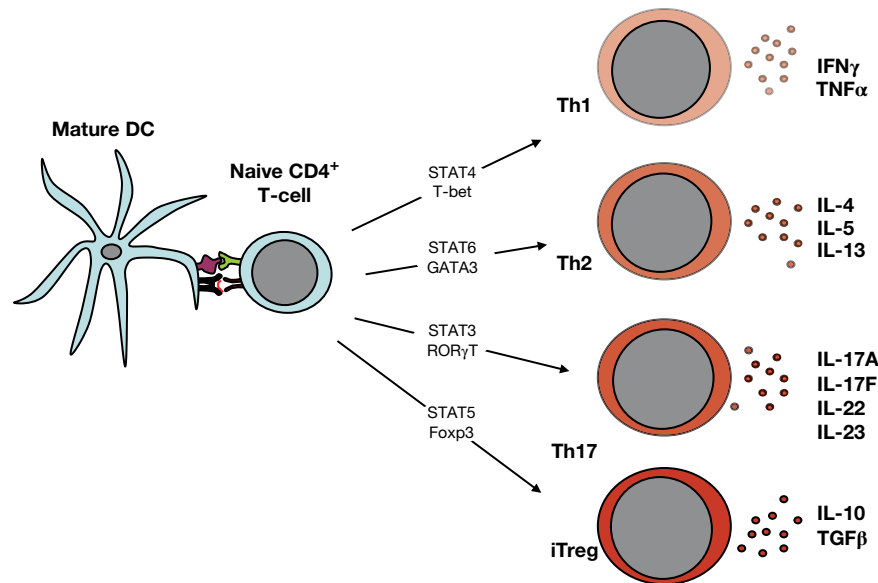


Figure 7.14 Regulation of T-cell differentiation by transcription factors. Specific T-cell lineages are produced by the action of key transcription factors, promoting differentiation and the secretion of a specific set of cytokines that subsequently modulate the immune response.

complex (i.e., signals 1 and 2), together with **key exogenous cytokines (signal 3) supplied by APCs and innate immune cells** that have been activated by a particular pathogen. Although TCR/CD28 stimulation provides signals to initiate and sustain T-cell proliferation, it is the accompanying innate immune cell-delivered cytokines that direct T-cell differentiation and thus shape the particular nature of the immune response. Collectively, these powerful signaling events promote activation of a number of key transcription factors, with associated expression of a myriad of proinflammatory genes that shape the outcome of T-cell activation (Figure 7.14).

Upon antigen stimulation, TCR/CD28 stimulation promotes the activation of three transcription factors, NF κ B, NFAT, and the AP-1 complex, which promote cell cycle entry, proliferation, and survival through activation of a host of target genes. Transcription of IL-2 is one of the key events in preventing the signaled T-cell from lapsing into anergy and is controlled by multiple binding sites for transcriptional factors in the promoter

region (Figure 7.11). Under the influence of calcineurin, the cytoplasmic component of the nuclear factor of activated T-cells (NFAT) becomes dephosphorylated and this permits its translocation to the nucleus where it forms a binary complex with NFAT_n, its partner, which is constitutively expressed in the nucleus. The NFAT complex binds to two different IL-2 regulatory sites (Figure 7.11). Note here that the calcineurin effect is blocked by the anti-T-cell drugs cyclosporine and tacrolimus (see Chapter 15). PKC- and calcineurin-dependent pathways synergize in activating the multisubunit I κ B kinase (IKK), which phosphorylates the inhibitor I κ B, thereby targeting it for ubiquitination and subsequent degradation by the proteasome. Loss of I κ B from the I κ B-NF κ B complex exposes the nuclear localization signal on the NF κ B transcription factor, which then swiftly enters the nucleus. In addition, the ubiquitous transcription factor **Oct-1** interacts with specific octamer-binding sequence motifs. As well as secreting IL-2, activated T-cells also increase expression of the IL-2R to sustain IL-2 signaling.

Differentiation of activated T-cells is controlled by different master regulators of transcription

Expression of *T-bet* directs polarization to Th1 cells

Although endogenous signals such as IL-2 expression initiate and help to sustain proliferation, specific cytokines delivered by innate immune cells **direct differentiation of CD4⁺ T-cells** into specific types of effectors: Th1, Th2, and Th17 cells. In response to infection with virus or intracellular bacteria, or by phagocytosing infected cells, macrophages and DCs are activated and stimulated to secrete the Th1 polarizing cytokine IL-12. Naive CD4⁺ T-cells that recognize pathogen-derived peptide–MHC complexes presented to them by these activated DCs will also be exposed to copious amounts of IL-12, which binds to and activates the IL-12R on T-cell surfaces. Signal transducer and activator of transcription (STAT) proteins play an essential role in connecting signals from activated cell membrane cytokine receptors with intracellular pathways leading to gene induction. Accordingly, IL-12-induced activation of STAT4 is important for the induction of the Th1 master regulator *T-bet*. This transcription factor activates T-cell expression of the key **Th1 cytokines IFN γ and TNF α** , while simultaneously upregulating cell surface expression of the IL-12R, directing Th1 immune responses against intracellular pathogens and reinforcing the Th1 phenotype (Figure 7.14).

Expression of *GATA3* directs polarization to Th2 cells

In contrast, differentiation of Th2 cells is initiated by IL-4. Although the initial source of IL-4 is not entirely clear, stimulation of naive T-cells by this cytokine triggers the activation of STAT6, which turns on the **Th2 master transcription factor *GATA3***, required to promote gene expression and secretion of the **Th2 cytokines IL-4, IL-5, and IL-13** from activated Th2 cells. The role of GATA3 in Th2 cell differentiation is highlighted by the complete failure of GATA3-deficient mice to generate a Th2 response. IL-2 mediated STAT5 activation also plays a major role in IL-4 gene induction in Th2 cells, by binding to and enhancing expression at the IL-4 gene locus. Activated Th2 cells subsequently coordinate the response to extracellular pathogens by promoting IL-4-induced activation of B-cells to secrete IgE, IL-5-induced recruitment of eosinophils, IL-3- and IL-4-dependent activation of mast cells, and the alternative activation of macrophages through IL-4 and IL-13. Interestingly, GATA3 can also inhibit Th1 responses by down-regulating expression of the IL-12R, thereby reinforcing the Th2 response.

Expression of *Roryt* directs polarization to Th17 cells.

Th17 cells direct the immune response against extracellular bacteria and fungi and are activated by IL-6 and TGF β , which in turn, promote STAT3-mediated activation of the **master**

regulator of IL-17 differentiation, *Roryt*. This transcription factor promotes expression of the **Th17 cytokines IL-17A, IL17F, IL-22, and IL-23** in Th17-differentiated T-cells, which in turn activate many types of nonimmune cells, such as endothelial cells, to secrete inflammatory mediators which recruit and activate neutrophils at sites of infection. Additionally, STAT3 activation inhibits expression of the T-regulatory cell (Treg) master transcription factor Foxp3, thus sustaining Th17 polarization over Treg generation.

Expression of *Foxp3* directs polarization to Treg cells.

Tregs are a distinct type of T-lymphocyte that play an essential role in controlling the adaptive immune responses orchestrated by effector T-cells. While “natural” or thymic-derived Tregs are thought to be functionally differentiated cells that are released from the thymus, inducible Tregs (iTregs) can be differentiated from naive T-cells after antigen stimulation. iTregs are induced by stimulation with TGF β and IL-2 and are characterized by activation of ***Foxp3***. Activation of this master transcription factor promotes the expression of **TGF β and IL-10** cytokines in Tregs, which suppress effector T-cell responses in particular contexts (Figure 7.14).

CD8⁺ T-cell differentiation is under the control of *T-bet*

CD8⁺ cytotoxic T-cells (CTLs) play a central role in the response to intracellular pathogens. These cells are differentiated from naive CD8⁺ T-cells after peptide:MHC binding in the presence of a range of cytokines including IL-2, IL-12, IFN γ , IL-27, and IL-23. The concerted action of TCR/co-receptor triggering, together with these cytokines, promotes the proliferation, differentiation, and survival of CTLs together with the expression of the cytotoxic molecules **perforin and granzymes**, which CTLs use to rapidly kill virus-infected or tumorigenic cells. Similar to Th1 cells, the master regulator, T-bet, plays an important role in CTL differentiation. Once an infection has been cleared, CTL numbers contract by apoptosis, but a small percentage survive to differentiate into CD8⁺ memory T-cells. Memory T-cells are extremely long-lived, providing immunological memory perhaps as long as the life of the organism, and these cells are characterized by IL-7R expression, equipping them to respond rapidly to reinfection after stimulation with IL-7. What determines the switch from CD8⁺ CTL to memory CD8⁺ T-cell? Although CD8⁺ CTLs rely on ***T-bet***, memory CD8⁺ T-cells preferentially express a related master regulator, ***Eomes***, which may be important in driving the T-memory phenotype. Genetic ablation of *Eomes* had a profound effect on the generation of memory responses to viral infection while having little impact on cytotoxic CTL numbers.

Although the picture we have portrayed here is a relatively linear one, recent developments in single-cell analysis have revealed that T-cell activation towards a particular fate may be a relatively plastic process, with T-cell subsets that were once

thought of as terminally differentiated cell types, retaining an ability to redifferentiate to a different phenotype depending on the cytokine milieu and infection environment. We will delve deeper into the topic of T-cell effector generation in Chapter 8. Although we have concentrated on a relatively small number of genes that shape the outcome of T-cell activation, more than 70 genes are newly expressed within 4 hours of activation, leading to proliferation and the synthesis of several cytokines and their receptors (see Chapter 8). In addition, TCR stimulation promotes the expression of a range of metabolic genes that drive a radical change in the metabolism of activated T-cells, which we will address more closely towards the end of this chapter. Although the triggering of TCR complexes in response to cognate peptide:MHC binding may be the first step towards T-cell activation, it is clear that signals from the TCR and co-receptor complex, together with pathogen-specific information from external cytokines, trigger a gene expression program in naive T-cells that not only promotes proliferation but also coordinately transforms the outcome of activation to meet the challenges of a specific infection.

Epigenetic control of T-cell activation

Epigenetic control of gene expression regulates T-cell activation and differentiation

Activation and differentiation of T-cells into the correct effector subsets is fundamental to generating an immune response capable of fighting a specific infection. Accordingly, the genes controlling T-cell activation and differentiation are tightly controlled. Nuclear DNA is normally wrapped around proteins called **histones**, which act as spools around which DNA winds, allowing the cell to compact and order a large amount of genetic information into the relatively small confines of the nucleus. Importantly, histones act as guardians of genetic information by shielding genes from activating transcription factors and as such, histone modification introduces a important layer of regulation of gene expression. For example, posttranslational modifications of histones at specific amino acids may directly change the conformation of histone at that site and effectively loosen or tighten its grip on DNA, thereby making it more or less accessible for transcription factor binding and gene activation. This can also occur indirectly, where **histone modification** creates a binding site for chromatin-modifying factors, which can then change the structure of chromatin to activate or repress gene transcription at a particular locus. ChIP-sequencing (Chip-Seq) is an experimental technique that combines chromatin immunoprecipitation with large-scale DNA sequencing to detect binding sites between proteins and DNA on a genome-wide scale. This technology has uncovered many important histone modifications, including trimethylation of histone H3 at lysine 4 (**H3K4me3**), which promotes an active chromatin arrangement at particular genes, and **H3K27me3**, which may tighten chromatin and repress gene transcription. In addition, direct methylation of DNA at CpG sites may render genes less transcriptionally active and this can play an important role in gene regulation.

Epigenetic factors controlling T-cell polarization

Binding of DNA methyltransferases promotes the transfer of a methyl group to DNA CpG islands, which can act as a platform for binding of **methyl-CpG-binding domain proteins (MBDs)**. These proteins play an important role in gene regulation by recruiting chromatin remodeling factors that can compact the chromatin around a particular gene, thereby suppressing gene induction. Repressive regulation at the *I14* gene locus appears to play an important role in shaping the outcome of differentiation. Binding of the DNA methyltransferase Dnmt-1 to the *I14* locus recruits MBD2 to compact chromatin around the *I14* gene, blocking transcription factor access. Accordingly, genetic deletion of either of these factors leads to aberrant, GATA3-independent *I14* expression in non-Th2 subsets. The *I14* locus is further repressed by H3K27me3 in Th1 cells, while Th2 cells have activating H3K4Me3 at the *I14* gene, thus promoting *I14* transcription and the Th2 phenotype. Supporting Th1 polarization, activating H3K4Me3 modifications have been found at the *Ifng* locus in Th1 cells, which promote binding of the Th1 master regulator T-bet, with associated *Ifng* gene transcription. Conversely, transcription of *Ifng* in Th2 cells is repressed through DNA methylation, and trimethylation of histone H3K27me3, thus preferentially skewing towards Th2 differentiation in the presence of Th2 cytokines. Epigenetic control also extends to Th17 and Treg cells, which display activating H3K4Me3 at the *Roryt* and *Foxp3* genes respectively, together with repressive H3K27me3 marks at both gene loci in non-expressing Th types. In this regard, deacetylation of histones and subsequent repression of gene activity at the *Foxp3* locus seems to play an important role in regulating Treg numbers, as mice deficient in the *Foxp3* deacetylase sirtuin 1 have increased numbers of Tregs and enhanced immunosuppression.

Epigenetic regulation is controlled by cytokines

As might be expected, transcription of the master regulators of Th1 and Th2 programming, T-bet and GATA3 also appear to be regulated by strong activating H3K4Me3 marks in each respective subtype, with the absence of inactivating H3K27me3 at these loci. Interestingly, together with inactivating H3K27me3, the *T-bet* and *Gata3* loci are also decorated with a small amount of activating H3K4Me3 in non-expressing subtypes. Decoration of histones with both activating and inactivating marks at the same gene is indicative of bivalent genes and indicates that these master regulators may be “poised” to undergo expression in non-expressing lineages when the occasion arises. This creates the intriguing possibility that activating and inhibitory histone modifications act as a switch to enhance the degree of plasticity of differentiation that has been observed between Th subtypes.

Enhancer elements are noncoding regions of genes that recruit transcription factors to turn on gene expression. These important determinants of cell type specificity have proved elusive to experimentally locate but recent developments in chromatin signature identification have facilitated genome-wide mapping of

gene enhancers. H3K4Me1 marks have been identified as an activating enhancer signature, as has the binding of acetyltransferase p300, both of which open up the enhancer region for transcription factor binding. A key question in T-cell biology has been how signals from the external and intracellular environment modulate the enhancer landscape, and thus activation, of master genes. Recent work has elegantly addressed this issue by using p300 and H3K4Me1 as probes in a genome-wide screen of enhancer regulators during CD8⁺ T-cell differentiation. While STAT-induced T-bet and GATA3 have been assumed to activate key Th1 and Th2 genes in a linear fashion, it now appears that STATs have a greater role to play than simply activating these master regulators. STATs have been found to promote binding of p300 to key Th1 and Th2 enhancers, and this was largely required to make the enhancer accessible for subsequent binding and activation by T-bet or GATA3, with H3K4Me1 playing a lesser role. Importantly, induced expression of T-bet or GATA3 was insufficient to activate expression of Th1 or Th2 genes in STAT-deficient cells, suggesting that in addition to activating key transcription factors, STAT proteins may act as “pioneer” factors that open up the enhancer landscape required for gene expression and differentiation (Figure 7.15).

Activated T-cells undergo an essential metabolic shift

Metabolic reprogramming drives T-cell activation and effector differentiation

It should now be apparent that lymphocyte activation triggers a myriad of signaling pathways that radically transform resting T-cells in preparation for effector function, and recent developments have uncovered a crucial role for specific metabolic pathways in not only fueling these changes, but in directing the outcome of T-cell differentiation into specific effector subtypes. Activated T-cells not only differ metabolically from their quiescent counterparts, differentiation into the various effector populations cannot proceed without distinct *metabolic reprogramming*.

Naive T-cells are constantly on the move, migrating through lymphoid tissues to patrol for signs of infection by endlessly sampling MHC–peptide complexes displayed by antigen-presenting cells. This dynamism, driven by constant cytoskeletal reorganization, is extremely energy demanding and requires an efficient method of ATP generation while at the same time necessitating minimal new biosynthesis. Resting T-cells use the highly efficient ATP-generating process of *oxidative phosphorylation* (OXPHOS) to supply their energy requirements. In simple terms, glucose is first broken down to pyruvate in the cytoplasm in a separate process called glycolysis, which also generates 2 molecules of ATP (Figure 7.16). Pyruvate is then converted into acetyl-CoA, the apical factor in a series of chemical reactions in the mitochondria called the *tricarboxylic acid (TCA) cycle*. The endpoint of the TCA

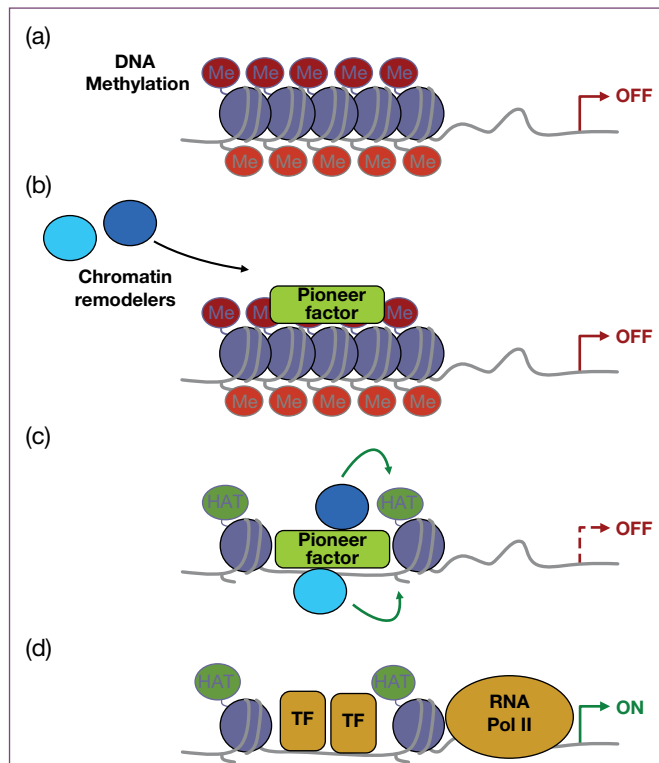


Figure 7.15 “Pioneer” factors can establish an enhancer landscape to facilitate gene expression. (a) Prior to T-cell activation, chromatin around gene enhancer regions remains in a conformation that is closed for gene transcription. (b) Following stimulation, “pioneer” transcription factors are recruited to enhancer regions. (c) Pioneer factors can displace the chromatin directly or recruit histone-modifying enzymes such as histone acetyltransferases (HAT) for this purpose, creating an open conformation for gene transcription. (d) Transcription factors (TF) can now bind and activate RNA polymerase II-mediated gene transcription.

cycle is the generate NADH for use as an electron donor in the mitochondrial electron transport chain, the oxygen-dependent process of OXPHOS, which produces up to 34 additional molecules of ATP from a single glucose molecule. In addition, fatty acids and certain amino acids can be catabolized to supply acetyl-CoA to drive the TCA cycle and supply the electron transport chain. Therefore, resting T-cells use the OXPHOS pathway to convert the majority of their nutrient supply, in the form of sugar, fatty acids, and protein, into ATP.

In low oxygen conditions, cells can make do with the less efficient glycolysis pathway to generate their energy needs, where instead of being used as an intermediate to drive the TCA cycle, glucose-derived pyruvate is converted to lactate to generate NAD⁺ to restart the glycolytic process, yielding a meagre 2 molecules of ATP per molecule of glucose (Figure 7.16). It may come as a surprise then, that activated T-cells primarily use glycolysis to generate ATP even in the presence of oxygen, in a process termed *aerobic glycolysis*. While counterintuitive at first, an appreciation of what T-cell activation sets out to

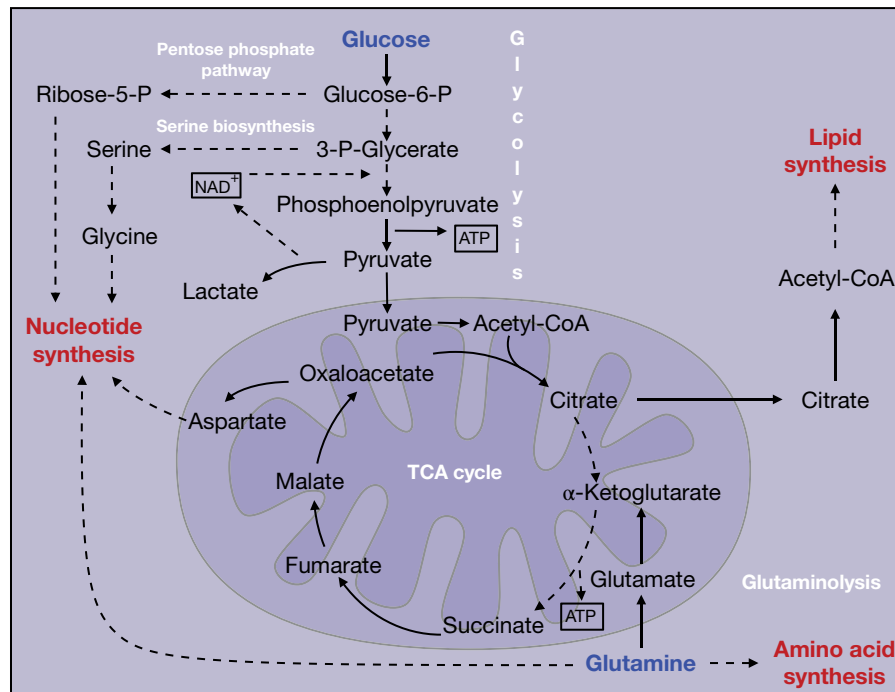


Figure 7.16 Metabolic pathways driving growth and proliferation. Glycolysis and the tricarboxylic acid (TCA) cycle function separately and in combination to generate ATP and biosynthesis-promoting metabolites. Glucose is first broken down into pyruvate, which can then be converted to NAD^+ and used to re-start glycolysis. A small amount of pyruvate can also be used as a source of acetyl-CoA to drive the TCA cycle in mitochondria. Intermediates from the glycolysis pathway can be siphoned off and used by the pentose phosphate pathway to produce ribose-5P and by the serine biosynthesis pathway to generate serine, both of which can be used to make nucleotides. Citrate can be removed from the TCA cycle and used to regenerate acetyl-CoA for lipid biosynthesis. To keep the TCA cycle moving in the absence of citrate, glutamine is converted to glutamate through glutaminolysis, and then to α -ketoglutarate, to re-enter the cycle. Oxaloacetate can also be used to generate aspartate for nucleotide synthesis.

achieve sheds light on this strange choice of energy-producing system. In contrast to quiescent T-cells, which require abundant energy but only minimal levels of new biosynthesis, activated T-cells must rapidly proliferate and differentiate into effector T-cells to meet the challenge of infection, a process that not only requires energy but also considerable **new biosynthesis to generate daughter cells and inflammatory cytokines**. While generating a low yield of ATP, glycolysis produces a wealth of metabolites essential for building new cells and proteins. Importantly, derivatives from glycolysis can be siphoned off and used in the pentose phosphate and serine biosynthesis pathways to produce an abundant supply of metabolic precursors for nucleotide and fatty acid synthesis (Figure 7.16). During aerobic glycolysis, most pyruvate is converted to lactate but a small amount is shunted into a modified TCA cycle, where citrate is extracted and used to synthesize lipids crucial for building cell membranes, while fatty acid catabolism is actively inhibited. To keep this improvised TCA cycle moving, glutamine is converted to glutamate and then to α -ketoglutarate in a process called glutaminolysis, which replaces the α -ketoglutarate that would otherwise have been generated by citrate. In summary, activated T-cells turn the majority of their nutrient supply

into biomass to build an army of antigen-specific daughter cells and crucial inflammatory mediators with which to fight an infection (Figure 7.16).

Signals from the TCR, co-stimulatory molecules, and cytokines coordinate the metabolism of activated T-cells

Although many cell types tailor their metabolic profile based on the nutrients available to them, the transition of antigen-stimulated T-cells to aerobic glycolysis is driven by signals propagated directly by the TCR complex, maintained by CD28 co-stimulation, and fine-tuned by inflammatory cytokines. TCR stimulation directly controls the switch from OXPHOS, where nutrients are consumed to generate ATP, to a **glycolytic, biomass-generating metabolism** to support the biosynthesis needed for daughter cells and inflammatory mediators. TCR triggering transmits these signals through serine-threonine kinases, which turn on a range of transcription factors and crucial regulators that together coordinate an increase in glucose and amino acid uptake essential for driving glycolysis while at the same time, **blocking the oxidation of lipids** to favor fatty acid synthesis to build cell membranes.

The transcription factor *c-Myc* is activated early on TCR stimulation by RAS-activated ERK1 and ERK2, and plays a crucial role in regulating glycolysis. *c-Myc* promotes the expression of essential glycolytic genes, including the cell membrane glucose transporter Glut1; glutaminase, which drives glutaminolysis; lactate dehydrogenase, essential for converting pyruvate into lactate to replenish the glycolytic cycle; and a number of glutamine transporters (Figure 7.16). The importance of glycolysis for T-cell activation is illustrated by the fate of *c-Myc*-deficient T-cells, which are completely incompetent for glycolysis and glutaminolysis and fail to proliferate on antigen stimulation.

TCR triggering also induces the expression of L-amino acid transporters on the cell membrane, promoting the influx of leucine, critical for activation of another important glycolysis regulator, the *mTORC1* complex. Increased intracellular leucine shunts mTORC1 to the lysosomal membrane, where it can be activated by RAS homolog enriched in brain (RHEB). Importantly, activation of the CD28 co-receptor complex is required for mTORC1 activation as CD28-induced activation of PI3K, in collaboration with *mTORC2*, facilitates AKT-mediated inactivation of the mTORC1 repressor TSC2, leading to mTORC1 activation. mTORC1 has multiple effects on T-cell activation, by increasing the rate of protein translation and by blocking fatty acid oxidation through SREBP2-mediated inhibition of CPT1a, a protein required for supplying the mitochondria with fatty acids to burn during OXPHOS. mTORC1 also activates *hypoxia-inducible factor 1 α* (*HIF1 α*), a transcription factor well known for promoting the expression of genes required for survival in oxygen-deprived environments. HIF1 α induces many of the genes required for glycolysis, and while the mTORC1/HIF1 α axis is not required for activating glycolysis at the early stages of TCR stimulation, their activation is essential for promoting the sustained glycolysis required for full T-cell activation. As CD28 triggering also activates glutamine transporters required for glutaminolysis, co-receptor stimulation through mTORC1/HIF1 α activation and glutamine import plays a crucial role in sustaining T-cell activation long enough for proliferation to occur, a point further illustrated by the action of the immunosuppressant drug rapamycin, which directly inhibits the mTORC1 complex, leading to a state of T-cell anergy. Thus, the coordinated efforts of *c-Myc*, the mTOR complex and HIF1 α trigger a switch to a glycolytic metabolism essential for fueling biosynthesis of antigen-specific daughter cells and inflammatory cytokines required to fight infection.

Conversely, activation of the glycolysis pathway is opposed by the cytosolic nutrient sensor *AMPK*, which blocks the activation of mTORC1, inhibiting glycolysis, and facilitating the accumulation of CPT1a, which promotes lipid oxidation in mitochondria, thus blocking lipid biosynthesis. AMPK is activated by an increased ratio of AMP:ATP, which indicates a drop in cellular ATP levels. In a finely tuned system of regulation, sufficient cellular ATP levels allow ATP to bind to and block an activating phosphorylation site on AMPK, preventing its phosphorylation by the AMPK-activating kinase LBK1. When the

cellular energy level drops and the AMP:ATP ratio increases, AMP can displace ATP from binding AMPK, thereby facilitating its activation by LBK1, and the promotion of OXPHOS and ATP generation over glycolysis and biosynthesis.

Metabolic control of T-cell differentiation

It should now be clear that metabolic reprogramming plays a crucial role in T-cell activation. However, the regulation does not end there. Specific metabolic programs are not only essential for the immune-stimulatory function of particular T-cell subsets, the individual nature of the metabolic signal also plays a crucial role in determining differentiation to the extent that inhibiting one metabolic signal over another is sufficient to shunt T-cell differentiation towards a different outcome. Genetic studies have revealed an essential role for the mTOR pathway in promoting Th1, Th2, and Th17 differentiation, with stimulation of mTOR-deficient cells leading mainly to differentiation of Tregs, which outlines a crucial role for mTOR in promoting effector T-cell (Teff) differentiation (Figure 7.17). Indeed, the layers of mTOR regulation extend to individual effector Th populations, with deletion of the mTORC1 activator Rheb biasing toward the Th2 effector cell phenotype while deletion of RICTOR, an essential component of the mTORC2 complex, favors generation of mainly Th1 and Th17 effectors (Figure 7.17). Thus, mTORC1 activation directs differentiation towards Th1 and Th17, while mTORC2 promotes Th2 production. While mTOR activation can skew towards Th1 or Th2 phenotypes, HIF1 α has a particularly important role in the differentiation of Th17 cells by activating the Th17-specific master transcription factor ROR γ t. In addition, HIF1 α can also bind the Treg-specific master regulator Foxp3, promoting its degradation and the inhibition of Treg differentiation. As such, genetic deletion of HIF1 α blocks Th17 responses and skews differentiation to Treg cells.

The reliance of Teff cell differentiation on the mTOR pathway indicates that these cells depend heavily on glycolysis and this makes sense as Teffs must rapidly proliferate to combat infection. In contrast, Treg and memory T-cells have a lower requirement for proliferation and as such, these cells rely mainly on fatty acid oxidation for energy, with minimal dependence on glycolysis. Indeed, Tregs display increased levels of AMPK, which represses mTOR activation and glycolysis. Whereas CD8⁺ T-cells mimic CD4⁺ effectors for a reliance on aerobic glycolysis to fuel rapid proliferation, CD8⁺ memory T-cells are long-lived cells that patrol the lymphatic tissues looking for signs of a recurrence of infection. As such, these cells rely less on biosynthesis and more on energy production and use fatty acid oxidation for their ATP generation requirements. This is reflected by increased expression of AMPK to repress glycolysis and CPT1a to drive lipid oxidation in mitochondria. Accordingly, deletion of TRAF6, which seems to be required for AMPK expression in memory CD8⁺ T-cells, has been found to severely blunt the memory response after initial infection.

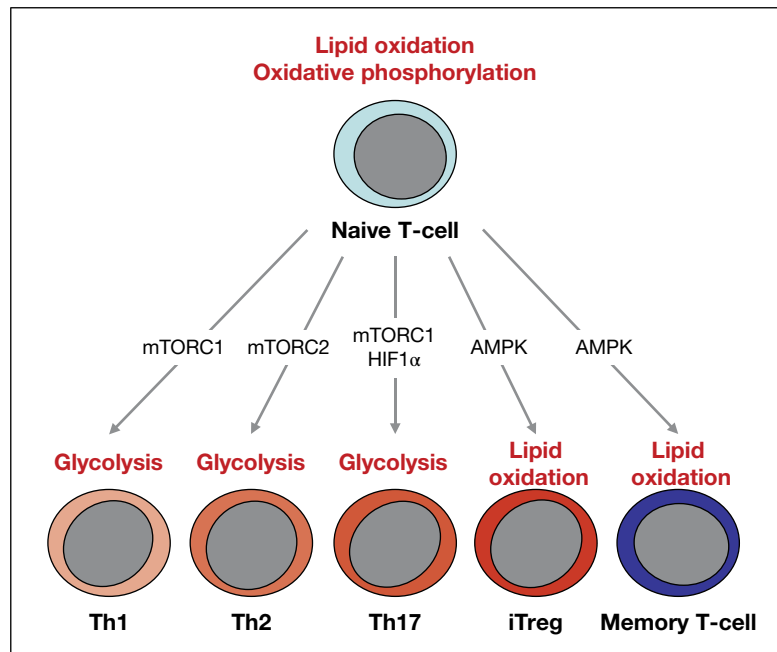


Figure 7.17 Regulation of T-cell differentiation and metabolism by transcription factors. T-cell specific metabolic signatures essential for function, and maintenance of T-cell subset, are driven by the action of key transcription factors.

Damping T-cell enthusiasm

We have frequently reiterated the premise that no self-respecting organism would permit the operation of an expanding enterprise such as a proliferating T-cell population without some sensible controlling mechanisms. There are some similarities here with regulations governing corporate takeovers in the business world, where it has been deemed prudent to ensure that no single enterprise is permitted to completely dominate the marketplace. Such monopoly practices, if allowed to occur in an unregulated way, would eventually eliminate all competition. Not a good thing for diversity or overall fitness.

In a similar vein, in order to preserve immunological diversity and the capacity to rapidly respond to new challenges of an infectious nature, it is necessary to ensure that T-cells specific for particular epitopes are not allowed to proliferate indefinitely and ultimately dominate the immune compartment. This would inevitably reduce the probability that responses to freshly encountered antigens would ever get off the ground, as naive T-cells would have to compete for access to DCs with overwhelming numbers of previously activated T-cells, with inevitable disastrous consequences for immunological fitness. For these reasons, our highly adapted immune systems have evolved ways of maintaining healthy competition between T-cells, which is achieved through downregulating immune responses upon clearance of a pathogen, along with culling of the majority of recently expanded T-cells. This is also necessary because the immune compartment is of a relatively finite size and cannot accommodate an infinite number of lymphocytes.

Damping down T-cell responses occurs via a number of mechanisms, some of which operate at the level of the activated T-cell itself, while others operate via additional T-cell subsets (*regulatory T-cells*) that use a variety of strategies to rein in T-cell responses, some of which are directed at the T-cell while others are directed at DCs. Regulatory T-cells will be discussed at length in Chapter 8, so here we will focus primarily on molecules present on activated T-cells that serve as “off switches” for such T-cells. Such molecules represent important immunological checkpoints, helping to keep T-cell responses within certain limits.

Signals routed through CTLA-4 downregulate T-cell responses

Cytotoxic T-lymphocyte antigen-4 (CTLA-4) is structurally related to CD28 and also binds B7 (CD80/CD86) ligands. However, whereas CD28–B7 interactions are co-stimulatory, CTLA-4–B7 interactions act in an opposite fashion and contribute to the termination of TCR signaling (Figure 7.18). Whereas CD28 is constitutively expressed on T-cells, ***CTLA-4 is not found on the resting cell but is rapidly upregulated within 3–4 hours following TCR/CD28-induced activation.*** CTLA-4 has a 10- to 20-fold higher affinity for both B7.1 and B7.2 and can therefore compete favorably with CD28 for binding to the latter even when present at relatively low concentrations. The mechanism by which CTLA-4 suppresses T-cell activation has been the subject of lively debate, as this receptor appears to recruit a similar repertoire of proteins (such as PI3K)

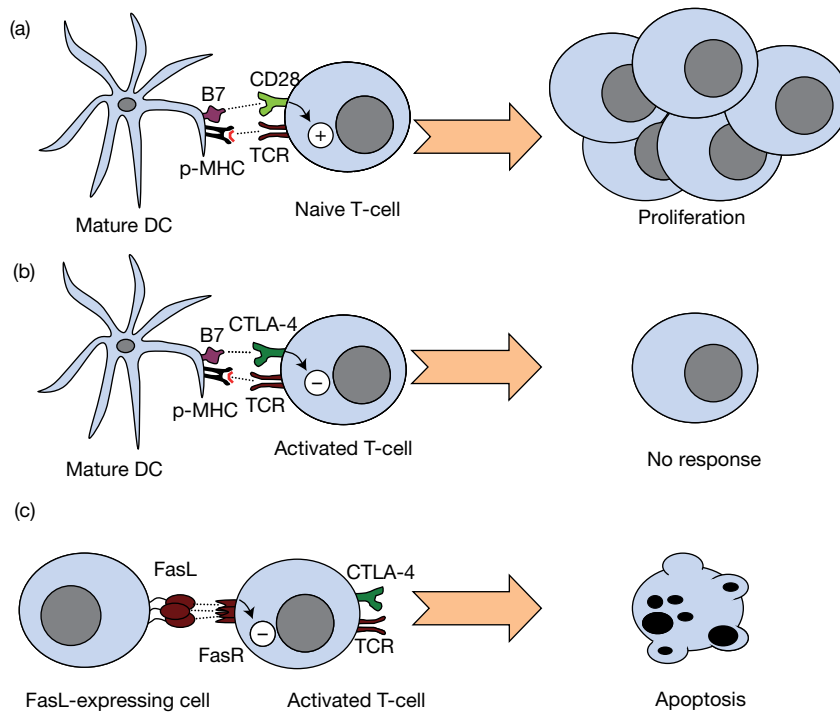


Figure 7.18 Downregulation of T-cell responses. (a) Antigen presentation by a mature dendritic cell (DC) provides effective antigenic stimulation via peptide–MHC (signal 1) and B7 ligands (signal 2) that engage the T-cell receptor (TCR) complex and CD28 on the T-cell, respectively. (b) Antigen presentation to a previously activated T-cell that is bearing surface CTLA-4 (a CD28-related molecule that can also interact with B7 ligands) can lead to T-cell unresponsiveness owing to inhibitory signals delivered through CTLA-4 co-stimulation (see main text for further details). (c) Whereas naive T-cells bearing surface Fas receptor are typically resistant to ligation of this receptor, activated T-cells acquire sensitivity to Fas receptor (FasR) engagement within a week or so of activation. Engagement of FasR on susceptible cells results in activation of the programmed cell death machinery as a result of recruitment and activation of caspase-8 within the FasR complex. Active caspase-8 propagates a cascade of further caspase activation events to kill the cell via apoptosis.

to its intracellular tail as CD28 does. A number of mechanisms have been proposed to account for the inhibitory effect of CTLA-4 on T-cell activation. One mechanism is by **simple competition with CD28 for binding of CD80/CD86 molecules on the DC**. Another is through recruitment of SHP-1 and SHP-2 protein tyrosine phosphatases to the TCR complex, which may contribute to the termination of TCR signals by dephosphorylating proteins that are required for TCR signal propagation. CTLA-4 may also antagonize the recruitment of the TCR complex to lipid rafts, which is where many of the signaling proteins that propagate TCR signals reside.

Although conventional T-cells require CTLA-4 expression to be induced after antigen engagement, Tregs constitutively express this receptor and this appears to play an important role in Treg-mediated immune suppression. Tregs can use CTLA-4 to bind CD80/CD86 on APCs, promoting trans-endocytosis and removal of B7 ligands from the APC cell surface, thereby downregulating immune responses. While this cell-extrinsic function of CTLA-4 is becoming widely recognized, it should be mentioned that Tregs also suppress immune responses in CTLA-4 independent ways (as will be discussed in Chapter 8). Irrespective of its mechanism of action, CTLA-4 is undoubtedly

critical for keeping T-cells under control and in this regard is also important for preventing responses to self antigen. CTLA-4-deficient mice display a profound hyperproliferative disorder and die within 3 weeks of birth as a result of massive tissue infiltration and organ destruction by T-cells.

PD-1 also represents an important T-cell checkpoint molecule

Another potent T-cell inhibitory receptor, **programmed death 1 (PD-1)**, is currently creating quite a stir because of the emerging clinical success of antitumor therapies that seek to block its action and reactivate the immune response against tumors expressing CTL-inhibitory PD-1 ligands on their surface. Similar to CTLA-4, PD-1 also belongs to the CD28 family of co-receptors, and mediates its inhibitory effect subsequent to antigen binding through recruitment of the phosphatase SHP-2, which dephosphorylates and inactivates proximal signaling adaptors such as ZAP-70 in T-cells and Syk in B-cells. Prior to antigen stimulation, T-cell PD-1 expression is upregulated then triggered by either of its two receptors: PD-L1, which is expressed mainly on nonlymphoid cells, and PD-L2, expressed on APCs.

Thus, like CTLA-4, PD-1 is involved in the suppression of T-cell-driven immune responses. Unlike CTLA-4 however, deficiency of which leads to fatal autoimmune disease in mice, loss of PD-1 has a less drastic outcome, resulting in the development of a range of different autoimmune diseases depending on the genetic background of the mice. This difference between PD-1 and CTLA-4 function seems to reflect a propensity for PD-1 activation to drive responses only in PD-1-expressing cells (cell intrinsic responses), whereas CTLA-4 responses are more far-reaching, not only through intrinsic processes but also through cell extrinsic T-cell-driven CTLA-4-mediated down-regulation of CD28 on APCs and effector T-cells.

Importantly, PD-L1 is expressed at significantly high levels on many tumor types, which is correlated with poor clinical prognosis. This indicates that **tumor cells may aggressively express PD-L1 on their surface to block CTL-mediated killing**. Indeed, preclinical animal studies using blocking antibodies directed against either PD-1 or PD-L1 have shown promising effects in re-stimulating the T-cell-mediated immune response to promote tumor regression. Many **PD-1/PD-L1 blocking therapies** are now in advanced phase clinical trials and have shown impressive clinical responses in multiple tumor types, including a 38% response rate by the anti-PD-1 drug MK-3475 in patients with advanced melanoma. Because PD-1 action is primarily cell intrinsic, immune-associated side-effects with PD-1-blocking therapies have been considerably less severe than with CTLA-4-inhibitory therapies, which have also proved successful in the clinic. Therapies designed at re-stimulating T-cell-mediated antitumor immunity are particularly desirable, as activating the adaptive immune system to target tumors not only offers an exquisite layer of precision, because of the generation of highly specific antigen receptors against tumor antigens, but also generates long-lived memory, which may significantly lessen the chances of tumor relapse.

Cbl family ubiquitin ligases restrain TCR signals

A number of other molecules have been identified that may be involved in reigning in T-cell activation and these include the **Cbl family** of proteins: c-Cbl, Cbl-b, and Cbl-c. Members of the Cbl family are **protein ubiquitin ligases** that can catalyze the degradation of proteins through attaching polyubiquitin chains to such molecules, thereby targeting them for destruction via the **ubiquitin-proteasome pathway**. The ζ chain of the CD3 co-receptor complex has been identified as a target for c-Cbl-mediated ubiquitination and this can result in internalization and degradation of the TCR complex. Thus, c-Cbl proteins may raise the threshold for TCR-induced signals through destabilizing this complex. Mice doubly deficient in c-Cbl and Cbl-b (which appear to exert somewhat redundant functions) exhibit hyperresponsiveness to TCR-induced signals, resulting in excessive proliferation and cytokine production in naive as well as differentiated effector T-cells; such mice die from autoimmune disease as a consequence. This appears to be due to a defect in downmodulation of the TCR complex in

activated T-cells. Whereas TCR complexes are normally internalized and degraded after stimulation via cognate peptide-MHC complexes (an event which contributes to the termination of TCR signals), TCR complexes fail to be internalized in c-Cbl/Cbl-b-deficient cells, leading to greatly extended TCR signaling and runaway T-cell expansion.

Cbl family proteins can also exert their influence on TCR signaling in other ways and may have an especially important role in maintaining the requirement for CD28 co-stimulation for proper T-cell activation. Surprisingly, mice deficient in Cbl-b lose the normal requirement for CD28 co-stimulation (i.e., signal 2) for T-cell proliferation; such cells make large amounts of IL-2 and proliferate vigorously in response to TCR stimulation alone. This implies that Cbl-b plays a major role in maintaining the requirement for signal 2 for activation of naive T-cells. Although it is not yet clear exactly how this operates, activation of Vav, which occurs downstream of TCR as well as CD28 receptor stimulation, appears to be suppressed by Cbl-b in wild-type cells. Thus, for effective Vav activation, signals 1 and 2 are normally required. However, in the absence of Cbl-b, a sufficient amount of Vav activation is achieved through TCR stimulation alone, bypassing the need for CD28 co-stimulation.

T-cell death occurs through stimulation of membrane Fas receptors

Another important way of standing down T-cells from active duty is to kill such cells through programmed cell death (Figure 7.18). Naive T-cells, as well as recently activated T-cells, express the membrane Fas (CD95) receptor, but are insensitive to stimulation via this receptor as these cells contain an endogenous inhibitor (FLIP) of the proximal signaling molecule caspase-8 that is activated as a result of stimulation through the Fas receptor. However, upon several rounds of stimulation, experienced T-cells become sensitive to stimulation via their Fas receptors, most likely owing to loss of FLIP expression, and this situation results in apoptosis of these cells. Mice defective in expression of either Fas or FasL manifest a lymphoproliferative syndrome that results in autoimmune disease due to a failure to cull recently expanded lymphocytes.

Dynamic interactions at the immunological synapse

As we have described above, successful TCR triggering involves a multitude of signal transduction events that culminate in T-cell activation. But what is the probability of this occurring in an *in vivo* setting? T-cells need to be highly efficient at finding their cognate antigen and discriminating between activating and non-activating peptide-MHC complexes for several reasons.

First, the numbers of T-cells bearing the correct TCRs for productive engagement with peptide-MHC are typically small; 1 in 100 000 or fewer cells being capable of responding to a particular peptide-MHC combination is not unusual. Therefore, T-cells need to be able to efficiently recognize the

correct peptide–MHC combination in a veritable sea of self peptide–MHC and non-activating peptide–MHC molecules. Because of the need to search for the correct peptide–MHC combination, **naive T-cells are in continual motion within a lymph node**, scanning at speeds that enable them to visit up to 5000 DCs in 1 hour; quite the social networkers! Because of this ferocious rate of movement, TCR–peptide–MHC interactions are very fleeting, as cells brush past each other at high speed. When an activating TCR–peptide–MHC interaction does occur, as few as 10 peptide–MHC complexes can persuade a T-cell to stop and linger, forming a more stable interaction that leads to the productive assembly of the **immunological synapse** (described below). Of course, the reader will understand that the T-cell needs to be pretty certain that this is the correct peptide–MHC complex to respond to, for if an error is made, the consequences are potentially calamitous and can result in autoimmunity.

The behavior of a T-cell within a lymph node as it searches for the correct peptide–MHC combination can be divided into several phases. Whereas T-cell movement is rapid during the seeking phase (phase I), encounter with agonistic peptide–MHC leads to stable T-cell–DC interactions lasting approximately 12 hours (phase II), during which cytokines such as IL-2 are produced. This is followed by a return to rapid movement involving further transient DC interactions (phase III), during which the T-cell divides a number of times and exits the lymph node.

A serial TCR engagement model for T-cell activation

We have already commented that the major docking forces that conjugate the APC and its T-lymphocyte counterpart must come from the complementary accessory molecules such as ICAM-1/LFA-1 and LFA-3/CD2, rather than through the relatively low-affinity TCR–MHC plus peptide links (Figure 7.3). Nonetheless, cognate antigen recognition by the TCR remains a *sine qua non* for T-cell activation. Fine, but how can as few as 10 MHC–peptide complexes on a DC, through their low-affinity complexing with TCRs, effect the Herculean task of sustaining a raised intracellular calcium flux for the 60 minutes required for full cell activation? Any fall in calcium flux, as may be occasioned by adding an antibody to the MHC, and NFAT_c dutifully returns from the nucleus to its cytoplasmic location, so aborting the activation process.

Surprisingly, Salvatore Valitutti and Antonio Lanzavecchia have shown that as few as 100 MHC–peptide complexes on an APC can downregulate 18 000 TCRs on its cognate T-lymphocyte partner. They suggest that each MHC–peptide complex can *serially* engage up to 200 TCRs. In their model, conjugation of a MHC–peptide dimer with two TCRs activates signal transduction, phosphorylation of the CD3-associated ζ chains with subsequent downstream events, and then downregulation of those TCRs. Intermediate affinity binding favors dissociation of the MHC–peptide, freeing it to engage and trigger another

TCR, so sustaining the required intracellular activation events. The model for **agonist** action would also explain why peptides giving interactions of lower or higher affinity than the optimum could behave as **antagonists** (Figure 7.19). The important phenomenon of modified peptides behaving as **partial agonists**, with differential effects on the outcome of T-cell activation, is addressed in the legend to Figure 7.19.

The immunological synapse

Experiments using peptide–MHC and ICAM-1 molecules labeled with different fluorochromes and inserted into a planar lipid bilayer on a glass support have provided evidence for the idea that T-cell activation occurs in the context of an immunological synapse. These and other imaging studies have revealed that the immunological synapse between the T-cell and the

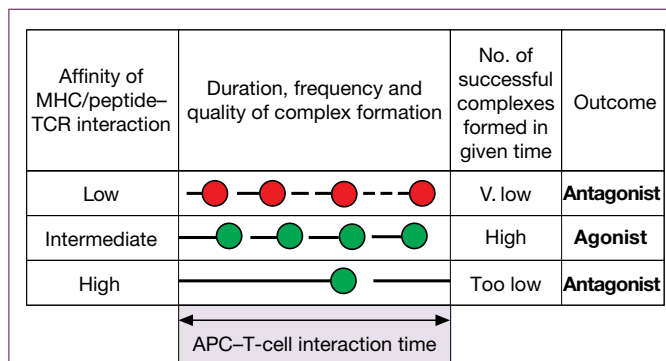


Figure 7.19 Serial triggering model of T-cell receptor (TCR) activation. Intermediate-affinity complexes between MHC–peptide and TCR survive long enough for a successful activation signal to be transduced by the TCR, and the MHC–peptide dissociates and fruitfully engages another TCR. A sustained high rate of formation of successful complexes is required for full T-cell activation. Low-affinity complexes have a short half-life that either has no effect on the TCR or produces inactivation, perhaps through partial phosphorylation of ζ chains. Green dots denote successful TCR activation; red dots denote TCR inactivation; and a dash denotes no effect. The length of the horizontal bar indicates the lifetime of that complex. Being of low affinity, they recycle rapidly and engage and inactivate a large number of TCRs. High-affinity complexes have such a long lifetime before dissociation that insufficient numbers of successful triggering events occur. Thus modified peptide ligands of either low or high affinity can act as antagonists by denying the agonist access to adequate numbers of vacant TCRs. Some modified peptides act as partial agonists in that they produce differential effects on the outcomes of T-cell activation. For example, a single residue change in a hemoglobin peptide reduced IL-4 secretion 10-fold but completely knocked out T-cell proliferation. The mechanism presumably involves incomplete or inadequately transduced phosphorylation events occurring through a truncated half-life of TCR engagement, allosteric effects on the MHC–TCR partners, or orientational misalignment of the peptide within the complex. (Source: Valitutti S. and Lanzavecchia A. (1995) *The Immunologist* 3, 122. Reproduced with permission of Hogrefe & Huber Publishers.)

DC has a “bull’s eye” pattern with a central cluster of TCR–peptide–MHC, known as the *cSMAC* (*central supramolecular activation complex*), surrounded by a ring of the integrin LFA-1 interacting with its cognate ligand ICAM-1 on the DC (Figure 7.20). Initially unstable TCR–MHC interactions occur outside of the integrin ring, followed by transit of the peptide–

MHC molecules into the *cSMAC*, changing places with the adhesion molecules that now form the outer ring (Figure 7.20). It has been suggested that the generation of the immunological synapse only occurs after a certain initial threshold level of TCR triggering has been achieved, its formation being dependent upon cytoskeletal reorganization and leading to potentiation of the signal. LFA-1 engagement with ICAM-1 is essential for formation of immunological synapses for a number of reasons. In the early stages of synapse formation, these molecules serve in a predominantly adhesive capacity to tether the opposing cells to facilitate TCR and peptide–MHC interactions, thereby allowing the T-cell to scan the peptide–MHC complex on offer.

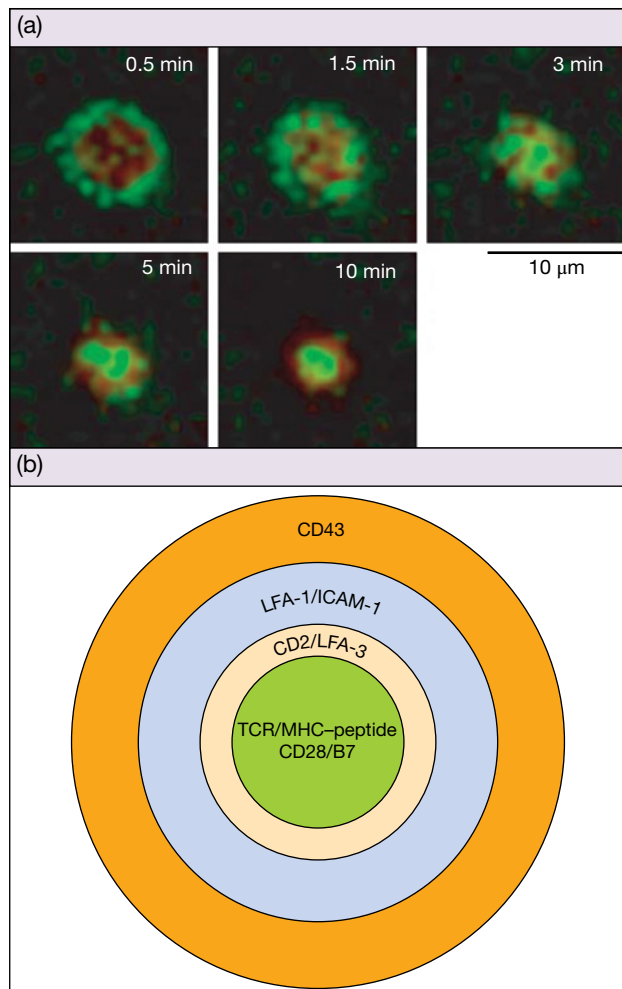


Figure 7.20 The immunological synapse. (a) The formation of the immunological synapse. T-cells were brought into contact with planar lipid bilayers and the positions of engaged MHC–peptide (green) and engaged ICAM-1 (red) at the indicated times after initial contact are shown. (Source: Grakoui A. *et al.* (1999) *Science* **285**, 221. Reproduced with permission of AAAS.) (b)

Diagrammatic representation of the resolved synapse in which the adhesion molecule pairs CD2/LFA-3 and LFA-1/ICAM-1, which were originally in the center, have moved to the outside and now encircle the antigen recognition and signaling interaction between TCR and MHC–peptide and the co-stimulatory interaction between CD28 and B7. The CD43 molecule has been reported to bind to ICAM-1 and E-selectin, and upon ligation is able to induce IL-2 mRNA, CD69, and CD154 (CD40L) expression and activate the DNA-binding activity of the AP-1, NFκB, and NFAT transcription factors.

B-cells respond to three different types of antigen

There are three main types of B-cell that respond to infection by secreting antibodies that target specific classes of microbes, with the particular function of each B-cell subset generally determined by their location. **Follicular B-cells** (also called B2 cells) express highly specific monoreactive B-cell receptors (BCRs), are present in the lymphoid follicles of the spleen and lymph nodes, and typically require T-cells in order to generate high-affinity antibodies, and to undergo class switching (Figure 7.21). However, as we shall discuss below, certain types of antigens (called T-independent antigens) can promote B-cell activation without the help of T-cells. The antibodies thus formed are typically of low affinity and do not undergo class switching or somatic hypermutation but provide rapid protection from certain microorganisms and buy time for T-dependent B-cell responses to be made. Such rapid antibody responses are mediated by the “innate like” B-cells; **B1** and **marginal zone (MZ) B-cells**, which express polyreactive BCRs that are of broad specificity and enable them to recognize multiple different kinds of evolutionarily conserved microbial antigens. In this way, they are similar to the Toll-like receptors (TLRs) expressed on conventional innate immune cells. Indeed, innate-like B-cells also express TLRs and can be directly activated by PAMPs, act as APCs, and secrete cytokines, which places them at the interface between the innate and adaptive immune systems. Importantly, this innate-like B-cell response is positioned at strategic areas that are sensitive to microbial invasion, such as the skin, mucosa, and the marginal zone of the spleen, where the lymphatic and circulatory systems converge.

1. Type 1 thymus-independent antigens

Certain antigens, such as bacterial lipopolysaccharides, when present at a sufficiently high concentration have the ability to activate a substantial proportion of the B-cell pool polyclonally (i.e., without reference to the antigen specificity of the surface receptor hypervariable regions). They do this through binding to surface molecules, such as TLRs as discussed in Chapter 1,

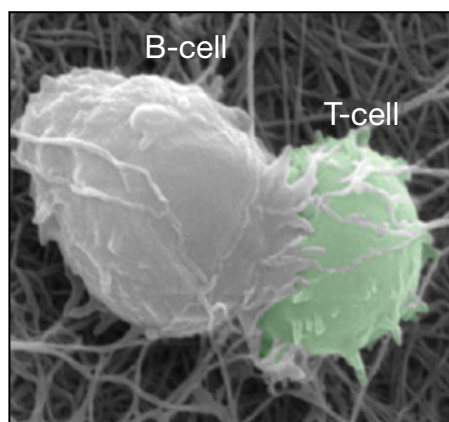


Figure 7.21 Interaction between B-cells and T-cells. Scanning electron microscope analysis of a cognate B-cell/T-cell pair, embedded in 3-D collagen matrix. (Source: Gunzer M. *et al.* (2004) *Blood* **104**, 2801–2809. Produced with permission of the American Society of Hematology.)

which bypasses the early part of the biochemical pathway mediated by the specific antigen receptor. At concentrations that are too low to cause polyclonal activation through unaided binding to these mitogenic bypass molecules, the B-cell population with Ig receptors specific for these antigens will selectively and passively focus them on their surface, where the resulting high local concentration will suffice to drive the activation process (Figure 7.22a).

2. Type 2 thymus-independent antigens

Certain linear antigens that are not readily degraded in the body and that have an appropriately spaced, highly repeating determinant – *Pneumococcus* polysaccharide, Ficoll, D-amino acid polymers, and polyvinylpyrrolidone, for example – are also thymus-independent in their ability to stimulate B-cells directly without the need for T-cell involvement. Such antigens persist for long periods on the surface of follicular DCs located at the subcapsular sinus of the lymph nodes and the splenic marginal zone, and can bind to antigen-specific B-cells with great avidity through their multivalent attachment to the complementary Ig receptors that they cross-link (Figure 7.22b).

In general, the thymus-independent antigens give rise to predominantly low-affinity IgM responses, some IgG3 in the mouse, and relatively poor, if any, memory. Neonatal B-cells do not respond well to type 2 antigens and this has important consequences for the efficacy of carbohydrate vaccines in young children.

This innate, T-cell-independent detection of microbial antigen is mediated by two types of B-cell: marginal zone (MZ) B-cells and B1 B-cells. MZ B-cells are located in the marginal zone of the spleen. This specialized area, located at the interface between the circulatory and lymphatic system, acts as a type of filter for blood-borne pathogens and MZ B-cells there constantly monitor the circulating levels of PAMP. In contrast, B1

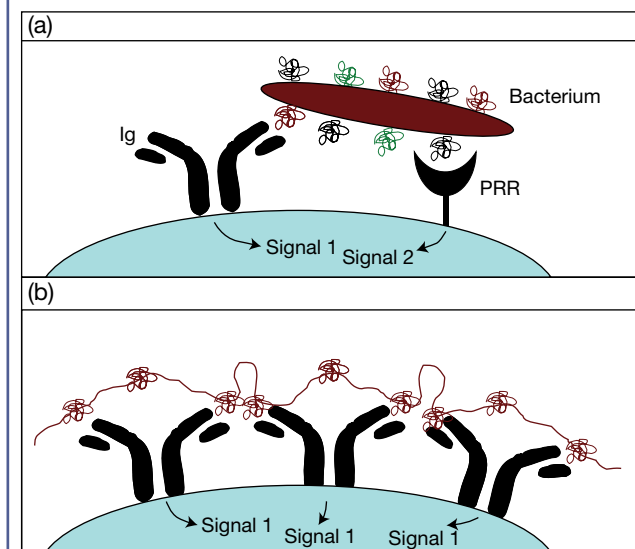


Figure 7.22 B-cell recognition of (a) type 1 and (b) type 2 thymus-independent antigens. The complex gives a sustained signal to the B-cell because of the long half-life of this type of molecule.

B-cells are found in the skin and mucosal surfaces, areas continually under siege from pathogens, and act as a rapid first line of defense against microbial invasion. Importantly, activation of both of these innate B-cell types by simultaneous trigger of BCR and TLRs not only promotes a strong IgM and IgG3 response, but also presents antigen to T-cells, thus quickly activating the adaptive immune response. Mice specifically deficient in B-cell Myd88, an essential signal transducer for TLRs, show strong defects in their ability to mount an antibody-mediated response to many types of infection, suggesting an important role for intrinsic TLR signaling in B-cell function.

3. Thymus-dependent antigens

The need for collaboration with T-helper cells

Many antigens are thymus-dependent in that they provoke little or no antibody response in animals that have been thymectomized at birth and therefore have few T-cells (Milestone 7.1). Such antigens cannot fulfill the molecular requirements for direct stimulation: they may be univalent with respect to the specificity of each determinant; they may be readily degraded by phagocytic cells; and they may lack mitogenicity. If they bind to B-cell receptors, they will sit on the surface just like a hapten and do nothing to trigger the B-cell (Figure 7.23). Cast your mind back to the definition of a hapten – a small molecule such as dinitrophenyl (DNP) that binds to preformed antibody (e.g., the surface receptor of a specific B-cell) but fails to stimulate antibody production (i.e., stimulate the B-cell). Remember also that haptens become immunogenic when coupled to an appropriate carrier protein. Building on the knowledge that both T- and B-cells are necessary for antibody responses to thymus-dependent

antigens (Milestone 7.1), we now know that the carrier functions to stimulate T-helper cells that cooperate with B-cells to enable them to respond to the hapten by providing accessory signals (Figure 7.23). It should also be evident from Figure 7.23 that, while one determinant on a typical protein antigen is behaving as a hapten in binding to the B-cell, the other determinants subserve a carrier function in recruiting T-helper cells.

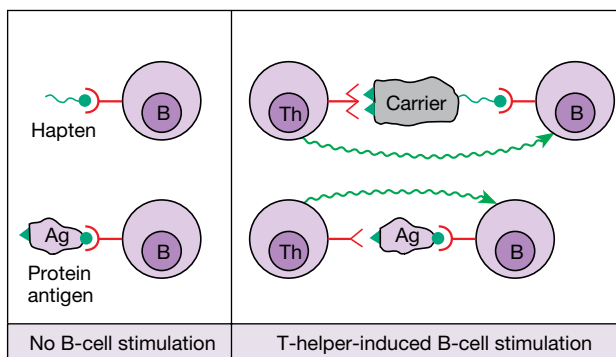


Figure 7.23 T-helper cells cooperate through protein carrier determinants to help B-cells respond to hapten or equivalent determinants on antigens (Ag) by providing accessory signals. (For simplicity we are ignoring the MHC component and epitope processing in T-cell recognition, but we won't forget it.)

Antigen processing by B-cells

The need for *physical linkage of hapten and carrier* strongly suggests that T-helpers must recognize the carrier determinants on the responding B-cell in order to provide the relevant accessory stimulatory signals. However, as T-cells only recognize processed membrane-bound antigen in association with MHC molecules, the T-helpers cannot recognize native antigen bound simply to the Ig receptors of the B-cell as naively depicted in Figure 7.23. All is not lost, however, as *primed B-cells can present antigen to T-helper cells* (Figure 7.24) – in fact, they work at much lower antigen concentrations than conventional presenting cells because they can focus antigen through their surface receptors. Antigen bound to surface Ig is internalized in endosomes that then fuse with vesicles containing MHC class II molecules with their invariant chain. Processing of the protein antigen then occurs as described in Chapter 5 (see Figure 5.16) and the resulting antigenic peptide is recycled to the surface in association with the class II molecules, where it is available for recognition by specific T-helpers (Figure 7.25 and Figure 7.26). The need for the physical union of hapten and carrier is now revealed; the hapten leads the carrier to be processed into the cell, which is programmed to make anti-hapten antibody and, following stimulus by the T-helper-recognizing processed carrier, it will carry out its program and ultimately produce antibodies that react with the hapten (is there no end to the wiliness of nature?).



Milestone 7.1 T-B collaboration for antibody production

In the 1960s, as the mysteries of the thymus were slowly unraveled, our erstwhile colleagues pushing back the frontiers of knowledge discovered that neonatal thymectomy in the mouse abrogated not only the cellular rejection of skin grafts, but also the antibody response to some but not all antigens (Figure M7.1.1). Subsequent investigations showed that both thymocytes and bone marrow cells were needed for optimal antibody responses to such *thymus-dependent antigens* (Figure M7.1.2). By carrying out these transfers with cells from animals bearing a recognizable chromosome marker (T6), it became evident that the antibody-forming cells were derived from the bone marrow inoculum, hence the nomenclature “T” for thymus-derived lymphocytes and “B” for antibody-forming cell precursors originating in the bone marrow. This convenient nomenclature has stuck even though bone marrow contains embryonic T-cell precursors, as the immunocompetent T- and B-cells differentiate in the thymus and bone marrow, respectively (see Chapter 10).




Thymectomy	Ag injected	Antibody response
Sham	Tetanus toxoid or Pneumococcal polysaccharide SIII 	+++
Neonatal	Tetanus toxoid 	-
Neonatal	Pneumococcal polysaccharide 	+++

Figure M7.1.1 The antibody response to some antigens is thymus dependent and, to others, thymus independent. The response to tetanus toxoid in neonatally thymectomized animals could be restored by the injection of thymocytes.





Cells injected	None	Thymocytes (T)	Bone marrow (B)	Thymocytes & Bone marrow
X-irradiated recipient inj. with thymus-dependent Ag				
Production of Ab	-	-	+	+++

Figure M7.1.2 The antibody response to a thymus-dependent antigen requires two different lymphocyte populations. Different populations of cells from a normal mouse histocompatible with the recipient (i.e., of the same H-2 haplotype) were injected into recipients that had been X-irradiated to destroy their own lymphocyte responses. They were then primed with a thymus-dependent antigen such as sheep red blood cells (i.e., an antigen that fails to give a response in neonatally thymectomized mice; Figure M7.1.1) and examined for the production of antibody after 2 weeks. The small amount of antibody (Ab) synthesized by animals receiving bone marrow alone is due to the presence of thymocyte precursors in the cell inoculum that differentiate in the intact thymus gland of the recipient.

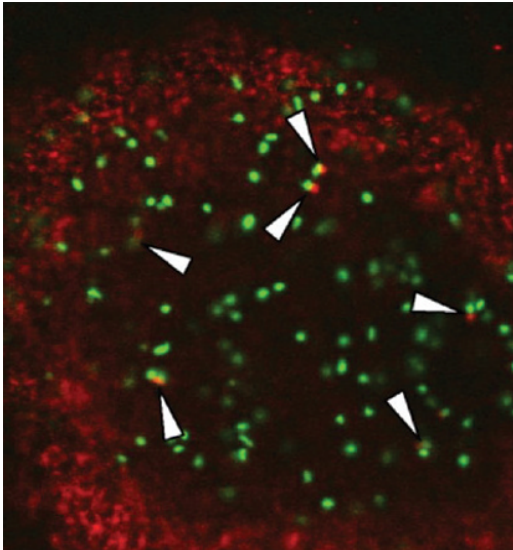


Figure 7.24 T- and B-cell interaction in a B-cell follicle. Multiple T-cell (red) and B-cell (green) pairs form at the T zone border within a B-cell follicle (arrowheads). (Source: Gunzer M. *et al.* (2004) *Blood* **104**, 2801–2809. Produced with permission of the American Society of Hematology.)

The nature of B-cell activation

Similar to T-cells, naive or resting B-cells are nondividing and activation through the BCR drives these cells into the cell cycle. As is the case for the TCR, the BCR (surface Ig) does not possess any intrinsic enzymatic activity. Once again, it is the accessory molecules associated with the antigen receptor that propagate activation signals into the B-cell. It was noted in Chapter 4 that the BCR complex is composed of membrane-anchored immunoglobulin that is associated with a disulfide-linked Ig- α and Ig- β heterodimer, the cytoplasmic tails of which each contain a single ITAM motif (see Figure 4.4). As we will now discuss in more detail, antigen-driven cross-linking of the BCR results in the initiation of a

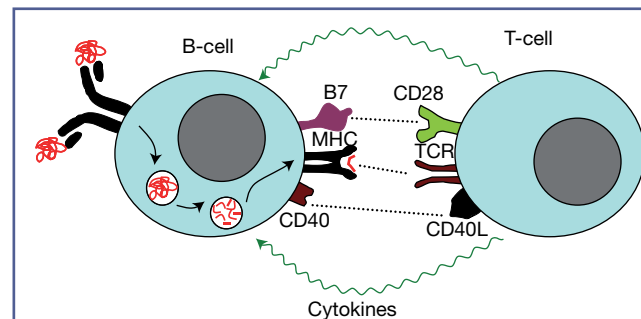


Figure 7.25 B-cell handling of a thymus-dependent antigen and presentation to an activated T-cell. Antigen captured by the surface Ig receptor is internalized within an endosome, processed, and expressed on the surface of the B-cell with MHC class II (see Figure 5.16). Co-stimulatory signals through the CD40–CD40L (CD154) interaction are required for the activation of the resting B-cell by the T-helper cell. In addition to CD40L-based co-stimulation, helper T-cells also provide additional stimulation to the B-cell in the form of cytokines such as IL-4.

PTK-driven signaling cascade, seeded by the Ig- α/β ITAMs that awaken a panoply of transcription factors from their cellular slumber.

B-cells are stimulated by cross-linking surface Ig

B-cell activation begins with interaction between antigen and surface immunoglobulin. Recruitment of the BCR to lipid rafts is thought to play an important role in B-cell activation as surface Ig is normally excluded from lipid rafts but becomes rapidly recruited to rafts within minutes of Ig cross-linking (Figure 7.27); this event probably serves to bring the PTK *Lyn* into close proximity with the ITAMs within the cytoplasmic tails of the BCR-associated Ig- α/β heterodimer as *Lyn* is constitutively associated with lipid rafts. Upon recruitment, *Lyn* then adds phosphate groups to the tyrosine residues within the ITAMs of the cytoplasmic tails of the Ig- α/β complex. This is rapidly followed by binding of the PTK *Syk* to the ITAMs along with another kinase *Btk*

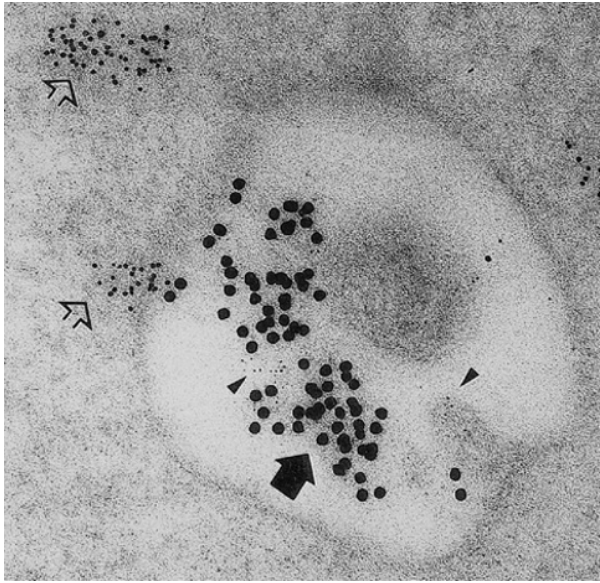


Figure 7.26 Demonstration that endocytosed B-cell surface Ig receptors enter cytoplasmic vesicles geared for antigen processing. Surface IgG was cross-linked with goat anti-human Ig and rabbit anti-goat Ig conjugated to 15 nm gold beads (large, dark arrow). After 2 minutes, the cell sections were prepared and stained with anti-HLA-DR invariant chain (2 nm gold; arrowheads) and an antibody to a cathepsin protease (5 nm gold; open arrows). Thus the internalized IgG is exposed to proteolysis in a vesicle containing class II molecules. The presence of invariant chain shows that the class II molecules derive from the endoplasmic reticulum and Golgi, not from the cell surface. Note the clever use of differently sized gold particles to distinguish the antibodies used for localizing the various intravesicular proteins, etc. (Source: Guagliardi L.E. *et al.* (1990) *Nature* **343**, 133. Reproduced with permission of Nature Publishing Group.)

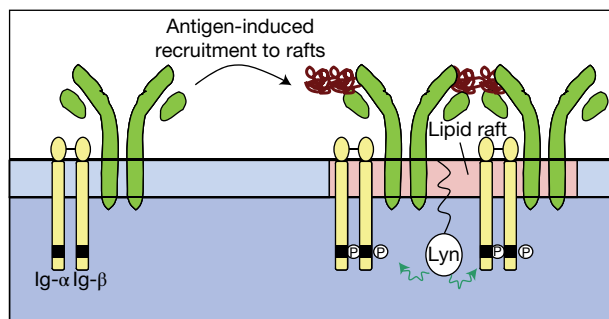


Figure 7.27 Receptor cross-linking recruits the BCR to lipid rafts. Antigen-induced receptor cross-linking recruits the BCR, which is normally excluded from membrane cholesterol-rich lipid raft domains, to membrane lipid rafts where signaling proteins such as the protein tyrosine kinase Lyn reside. Stable recruitment of the BCR to rafts facilitates Lyn-mediated phosphorylation of ITAMs within the cytoplasmic tails of the Ig- α and Ig- β accessory molecules that initiate the BCR-driven signaling cascade.

(*Bruton's tyrosine kinase*). Active Lyn also phosphorylates residues on CD19, a component of the B-cell co-receptor complex (discussed in detail in the next section) that reinforces signals initiated by the BCR (Figure 7.28).

Syk fulfills a critical role within the B-cell activation process; disruption of the gene encoding Syk in the mouse has profound effects on downstream events in B-cell signaling and results in defective B-cell development. In this respect, Syk serves a similar role in B-cells to that served by ZAP-70 in T-cells. Active Syk phosphorylates and recruits *BLNK* (B-cell linker; also called SLP-65, BASH, and BCA) to the BCR complex. Upon phosphorylation by Syk, BLNK provides binding sites for *phospholipase C γ 2* (PLC γ 2), Btk, and *Vav*. Recruitment of Btk in close proximity to PLC γ 2 enables Btk to phosphorylate the latter and increase its activity. Just as in the

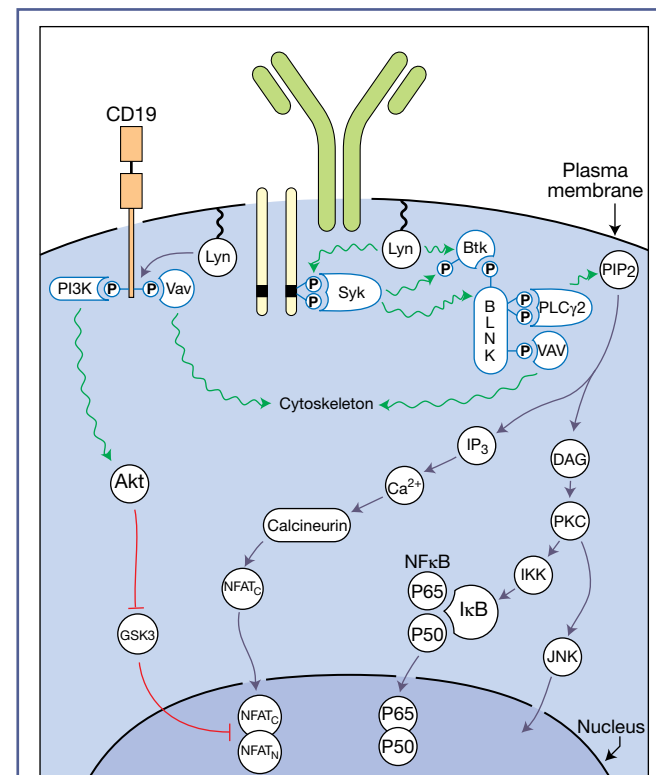


Figure 7.28 Signaling cascade downstream of antigen-driven B-cell receptor (BCR) ligation. Upon interaction with antigen, the BCR is recruited to lipid rafts where ITAMs within the Ig- α / β heterodimer become phosphorylated by Lyn. This is followed by recruitment and activation of the Syk and Btk kinases. Phosphorylation of the B-cell adaptor protein BLNK creates binding sites for several other proteins, including PLC γ 2 that promotes PIP $_2$ hydrolysis and instigates a chain of signaling events culminating in activation of the NFAT and NF κ B transcription factors. The CD19 co-receptor molecule is also phosphorylated by Lyn and can suppress the inhibitory effects of GSK3 on NFAT through the PI3K/Akt pathway. BCR stimulation also results in rearrangement of the cell cytoskeleton via activation of Vav that acts as a guanine nucleotide exchange factor for small G-proteins such as Rac and Rho.

T-cell signaling pathway, activated PLC γ 2 initiates a pathway that involves hydrolysis of PIP $_2$ to generate diacylglycerol and inositol trisphosphate and results in increases in intracellular calcium and PKC activation (Figure 7.28). PKC activation, in turn, results in activation of the *NF κ B* and *JNK* transcription factors and increased intracellular calcium results in *NFAT* activation, just as it does in T-cells.

The Vav family of guanine nucleotide exchange factors consists of at least three isoforms (Vav-1, -2, and -3) and is known to play a crucial role in B-cell signaling through activation of Rac1 and regulating cytoskeletal changes after BCR cross-linking; Vav-1-deficient B-cells are defective in proliferation associated with cross-linking of the BCR (Figure 7.27).

The BCR cross-linking model seems appropriate for an understanding of stimulation by type 2 thymus-independent antigens, as their repeating determinants ensure strong binding to, and cross-linking of, multiple Ig receptors on the B-cell surface to form aggregates that persist owing to the long half-life of the antigen and sustain the high intracellular calcium needed for activation. On the other hand, type 1 T-independent antigens, such as the T-cell polyclonal activators, probably bypass the specific receptor and act directly on downstream molecules such as diacylglycerol and protein kinase C, as Ig- α and Ig- β are not phosphorylated.

B-cells require co-stimulation via the B-cell co-receptor complex for efficient activation

Similar to T-cells, B-cells also require *two forms of co-stimulation* to mount efficient effector responses. One form of co-stimulation takes place at the point of initial encounter of the BCR with its cognate antigen and is provided by the **B-cell co-receptor complex** that is capable of engaging with molecules such as complement that may be present in close proximity to the specific antigen recognized by the BCR. The other form of co-stimulation required by B-cells takes place after the initial encounter with antigen and is provided by T-cells in the form of membrane-associated **CD40 ligand that engages with CD40** on the B-cell. This form of co-stimulation requires that the B-cell has internalized antigen, followed by processing and presentation on MHC class II molecules to an appropriate T-cell. If the B-cell is displaying an MHC-peptide combination recognized by the T-cell, the latter will be stimulated to produce cytokines (such as IL-4) as well as provide co-stimulation to the B-cell in the form of CD40L. We will consider the nature of the co-stimulatory signals provided by the B-cell co-receptor complex here and deal with CD40L-based co-stimulation in a separate section below.

The mature B-cell co-receptor complex (Figure 7.29) is composed of four components: CD19, CD21 (complement receptor type 2, CR2), CD81 (TAPA-1), and CD225 (LEU13, interferon-induced transmembrane protein 1). CR2 is a receptor for the C3d breakdown product of complement and its presence within the BCR co-receptor complex enables a component of the innate immune response (complement) to

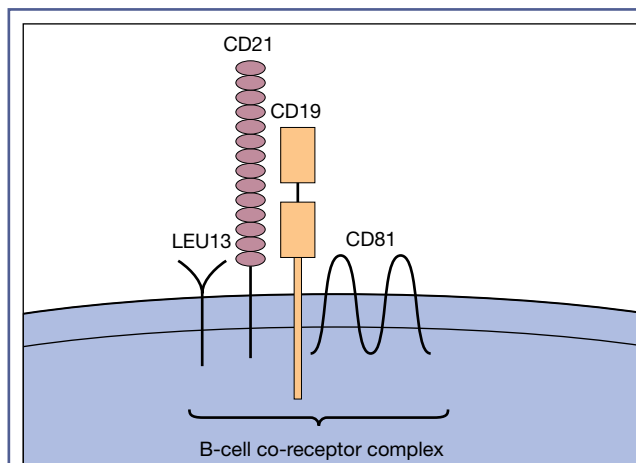


Figure 7.29 The B-cell co-receptor complex provides co-stimulatory signals for B-cell activation through recruitment of a number of signaling molecules, including phosphatidylinositol 3-kinase and Vav, which can amplify signals initiated through the B-cell receptor. On mature B-cells, CD19 forms a tetrameric complex with three other proteins: CD21 (complement receptor type 2), CD81 (TAPA-1), and CD225 (interferon-induced transmembrane protein 1) (LEU13). See also Figure 4.6.

synergize with the BCR to productively activate B-cells. Imagine a bacterium that has activated complement and has become coated with the products of complement activation, including C3d. If the same bacterium is subsequently captured by the BCR on a B-cell, there is now an opportunity for CR2 within the BCR co-receptor complex to bind C3d, which effectively means that the B-cell now receives two signals simultaneously. Signal 1 comes via the BCR and signal 2 via the co-receptor complex. So how does simultaneous engagement of the co-receptor complex and the BCR lead to enhanced B-cell activation?

Well, the answer is that we don't know for sure, but it is clear that CD19 plays an especially important role in this process. **CD19** is a B-cell-specific transmembrane protein that is expressed from the pro-B-cell to the plasma-cell stage and possesses a relatively long cytoplasmic tail containing nine tyrosine residues. Upon B-cell receptor stimulation, the cytoplasmic tail of CD19 undergoes phosphorylation at several of these tyrosine residues (by kinases associated with the BCR) that creates binding sites on CD19 for several proteins, including the tyrosine kinase Lyn, Vav, and phosphatidylinositol 3-kinase (PI3K). CD19 plays a role as a platform for recruitment of several proteins to the BCR complex (Figure 7.28), much in the same way that LAT functions in TCR activation.

Vav is recruited to CD19 upon phosphorylation of the latter by Lyn and, along with PI3K that is also recruited to CD19 as a result of Lyn-mediated phosphorylation (Figure 7.28), plays a role in the activation of the serine/threonine kinase *Akt*; the latter may also enhance NFAT activation through neutralizing the inhibitory effects of *GSK3*

(*glycogen synthase kinase 3*) on NFAT. Because GSK3 can also phosphorylate and destabilize Myc and cyclin D, which are essential for cell cycle entry, Akt activation also has positive effects on proliferation of activated B-cells.

Similar to the role that CD28 plays on T-cells, the B-cell co-receptor amplifies signals transmitted through the BCR approximately 100-fold. As we have discussed above, because CD19 and CR2 (CD21) molecules enjoy mutual association, this can be brought about by bridging the Ig and CR2 receptors on the B-cell surface by antigen–C3d complexes bound to the surface of APCs. Thus, antigen-induced clustering of the B-cell co-receptor complex with the BCR lowers the threshold for B-cell activation by bringing kinases that are associated with the BCR into close proximity with the co-receptor complex. The action of these kinases on the co-receptor complex engages signaling pathways that reinforce signals originating from the BCR.

B-cells also require co-stimulation from T-helper cells

Just as T-cells require co-stimulatory signals from DCs in the form of B7 ligands for productive activation (Figure 7.3), T-dependent B-cells also require co-stimulation from T-helper cells in order to cross the threshold required for clonal expansion and differentiation to effector cells (Figure 7.24). The sequence of events goes much like this. Upon encountering cognate antigen through direct binding to a microorganism,

the BCR undergoes the initial activation events described above. This culminates in the internalization of the BCR, along with captured antigen, which is then processed and presented on MHC class II molecules (Figure 7.30). To continue the process of maturation to either a plasma cell or a memory cell, the B-cell must now encounter a T-cell capable of recognizing one of the antigenic peptides the B-cell is now presenting from the antigen it has internalized. Note that this need not be the same epitope recognized by the B-cell to undergo initial activation. Upon encountering a T-cell with the appropriate TCR, the B-cell provides stimulation to the T-cell in the form of MHC–peptide as well as co-stimulatory B7 signals (Figure 7.30). In turn, the T-cell upregulates CD40 ligand (CD40L) that can provide essential co-stimulation to the B-cell, enabling the latter to become fully activated and undergo clonal expansion and class switching. If CD40L help is not forthcoming, B-cells rapidly undergo apoptosis and are eliminated. This help is provided by a special class of T-cell called a follicular helper T-cell, a distinct branch of CD4⁺ T-cells that express the cell surface receptor CXCR5, which targets them to B-cell follicles in the secondary lymphoid organs. Thus, B-cells and T-cells provide mutual co-stimulation as a means of reinforcing their initial activation signals (Figure 7.30). In effect, the B-lymphocyte is acting as an APC and, as mentioned above, it is very efficient because of its ability to concentrate the antigen by focusing onto its surface Ig. Nonetheless, although a preactivated T-helper can mutually

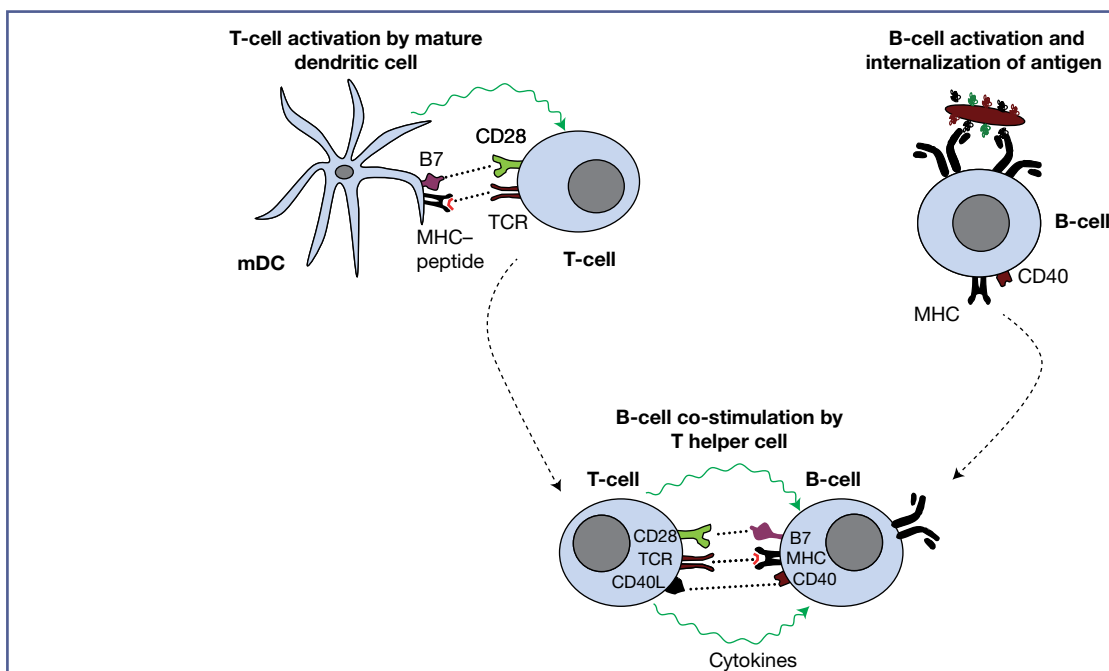


Figure 7.30 CD40–CD40L-dependent B-cell co-stimulation by a T-helper cell. Independently activated T- and B-cells can interact if the B-cell is presenting the correct peptide–MHC complex sufficient for stimulation of the T-cell. Successful antigen presentation by a B-cell to an activated T-helper cell results in CD40L-dependent co-stimulation of the B-cell as well as the provision of cytokines, such as IL-4, by the T-cell that are essential for class switching, clonal expansion and differentiation to effector cells.

interact with and stimulate a resting B-cell, a *resting* T-cell can only be triggered by a B-cell that has acquired the B7 co-stimulator and this is only present on activated, not resting, B-cells.

Presumably the immune complexes on follicular DCs in germinal centers of secondary follicles can be taken up by the B-cells for presentation to T-helpers, but, additionally, the complexes could cross-link the sIg of the B-cell blasts and drive their proliferation in a T-independent manner. This would be enhanced by the presence of C3 in the complexes as the B-cell complement receptor (CR2) is co-mitogenic.

Damping down B-cell activation

We have already discussed how T-cell enthusiasm for antigen can be dissipated by engaging CTLA-4; similar mechanisms also operate to damp down signals routed through the BCR. Several cell surface receptors, including FcγRIIB, CD22, and PIRB (paired immunoglobulin-like receptor B), have been implicated in antagonizing B-cell activation through recruitment of the protein tyrosine phosphatase SHP-1 to ***ITIMs*** (***immunoreceptor tyrosine-based inhibitory motifs***) in their cytoplasmic tails. SHP-1 impairs BCR signaling by antagonizing the effects of the Lyn kinase on Syk and Btk; by dephosphorylating both of these proteins SHP-1 blocks recruitment of PLCγ2 to the BCR complex. Co-ligation of the BCR with any of these receptors is therefore likely to block B-cell activation. CD22 appears to be constitutively associated with the BCR in resting B-cells and in this way may raise the threshold for B-cell activation. Successful formation of a B-cell receptor synapse may physically exclude CD22 from the BCR complex.

Dynamic interactions at the BCR synapse

Just as TCRs form immunological synapses during contact with specific peptide–MHC, B-cell receptors have also been found to exhibit similar behavior, particularly when antigen is presented on a membrane surface. Although B-cells can be stimulated by soluble antigen, it is now widely accepted that ***the primary form of antigen that triggers B-cell activation in vivo is localized to membrane surfaces***. The most likely culprits here are the follicular DCs that are resident within lymph nodes, as well as macrophages and DCs that migrate there bearing gifts of antigen. Antigens can be immobilized on cell surfaces by complement or Fc receptors as immunocomplexes, or through direct binding to various scavenger receptors. An encounter between a B-cell and membrane-associated antigen provides the opportunity for the B-cell membrane to spread along the opposing membrane, gathering sufficient antigen to trigger B-cell activation, as well as providing an opportunity for other contacts to be made, such as those that can be provided by membrane integrins. This spreading response is driven by BCR engagement of antigen at the leading edge of the B-cell and, apart from increasing the number of BCR–antigen

contacts that are then available to trigger B-cell activation, the spreading response ***also increases the amount of antigen that is ultimately concentrated and internalized by the B-cell***, leading to more efficient antigen presentation to activated T-cells when the B-cell subsequently goes looking for T-cell help (Figure 7.30).

Cell spreading in response to engagement of the BCR with specific antigen is triggered in response to signals propagated via the BCR, with Lyn and Syk playing especially important roles in this process. Clearly, spreading along an antigen-bearing surface requires extensive reorganization of the cytoskeleton. Although this is not fully understood at present, activation of Vav, which as discussed earlier is involved in the regulation of the cytoskeleton via Rac and Rho, is essential here.

There is evidence that BCRs within resting B-cells are not scattered randomly within the plasma membrane but are confined to certain zones, with free diffusion restricted by contacts with the underlying actin-based cytoskeleton. In line with this, disruption of the actin network in B-cells has been shown to lead to spontaneous BCR-dependent calcium signaling, possibly owing to the spontaneous formation of ***BCR microclusters***. Thus, the cytoskeleton appears to play an important role in restricting the surface distribution and behavior of BCRs in a resting B-cell. Binding of multivalent antigen to the BCR can disrupt the arrangement of BCRs in the resting B-cell, resulting in the formation of BCR microclusters containing 50–500 BCRs, the formation of which also depends on an intact cytoskeleton. Indeed, the actin network within activated B-cells has been found to encircle or corral BCR microclusters within the plasma membrane.

Spreading of the B-cell across the antigen-bearing surface increases the number of BCR microclusters and eventually engages sufficient numbers of BCRs to permit crossing of the threshold for B-cell activation. Similar to T-cells, mature B-cells also express high levels of the LFA-1 and VLA-4 integrins. Interaction of these adhesion molecules with their cognate ligands, ICAM-1 and VCAM-1/fibronectin, on the cell that is displaying the immobilized antigen also promote B-cell adhesion and facilitate cell spreading along the target surface. Following spreading across an antigen-bearing surface, B-cells undergo a prolonged contraction phase that culminates in a major rearrangement of the BCR microclusters within the membrane that coalesce to form an immunological synapse, similar to that seen with T-cells (Figure 7.21). The mature BCR immunological synapse contains a central ring (cSMAC) enriched in BCR–antigen complexes, with an outer ring (pSMAC) enriched in integrins (Figure 7.31). Not only do the integrin contacts promote spreading and adhesion between the interacting cell pairs, but recent evidence also suggests that such contacts lower the threshold for B-cell activation by lowering the concentration of antigen required to form a stable synapse and trigger the B-cell.

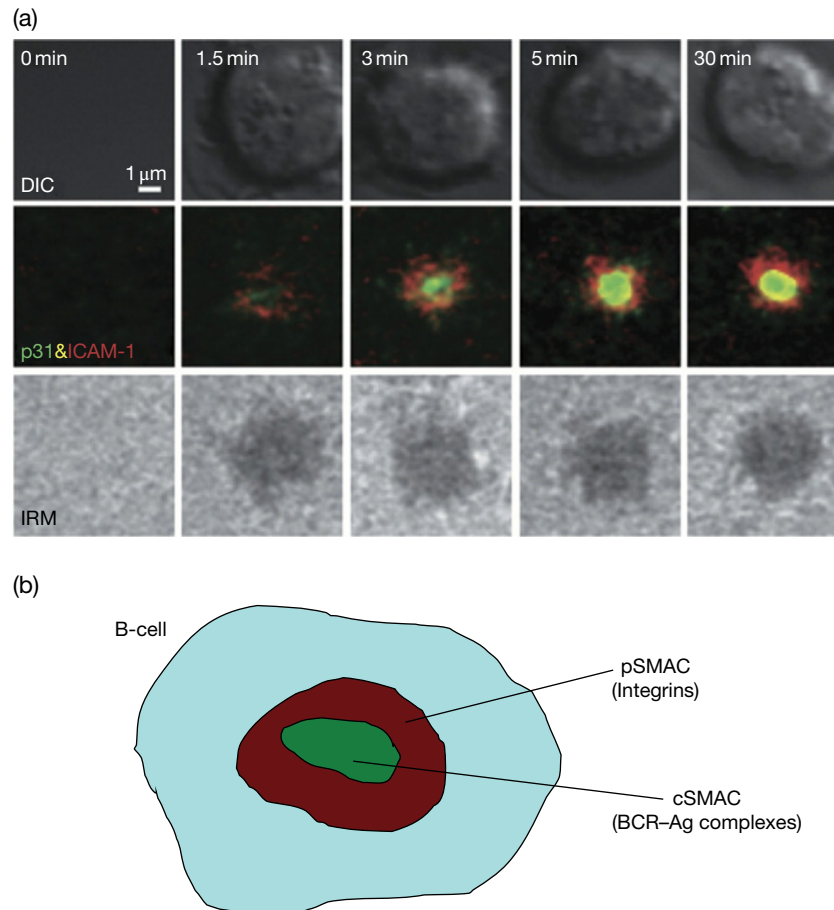


Figure 7.31 The B-cell receptor (BCR) immunological synapse. (a) Imaging of the BCR immunological synapse. Real-time quantification of antigen and ICAM-1 recruitment to the B-cell synapse. naive B-cells were settled onto planar lipid bilayers containing glycosylphosphatidylinositol (GPI)-linked ICAM-1 (red) and p31 antigen (green). Central panels show the accumulation of the antigen p31 (green) and ICAM-1 (red) in the pattern of a mature synapse at the specified time points. Top and bottom panels show differential interference contrast and interference reflection microscopy images of the same time points. (Source: Carrasco Y.R. *et al.* (2004) *Immunity* **20**, 589–599. Reproduced with permission of Elsevier.) (b) Schematic representation of the BCR immunological synapse, depicting the central supramolecular activation complex (cSMAC) that is enriched in BCR–Ag microclusters, and the surrounding peripheral supramolecular activation complex (pSMAC) that is enriched in integrins such as LFA-1/ICAM-1.

Immunocompetent T- and B-cells differ in many respects

- The antigen-specific receptors, TCR/CD3 on T-cells and surface Ig on B-cells, provide a clear distinction between these two cell types.
- T- and B-cells differ in their receptors for C3d, IgG, and certain viruses.
- There are distinct polyclonal activators of T-cells (PHA, anti-CD3) and of B-cells (anti-Ig, Epstein–Barr virus).

T-lymphocytes and antigen-presenting cells interact through pairs of accessory molecules

- The docking of T-cells and APCs depends upon strong mutual interactions between complementary molecular pairs on their surfaces: MHC II–CD4, MHC I–CD8,

VCAM-1–VLA-4, ICAM-1–LFA-1, LFA-3–CD2, B7–CD28 (and CTLA-4).

- B7–CTLA-4 interactions are inhibitory, whereas B7–CD28 interactions are stimulatory. CTLA-4 may antagonize the recruitment of the TCR to lipid rafts where many membrane-associated signaling proteins reside.

Activation of T-cells requires two signals

- Two signals activate T-cells, but one alone produces unresponsiveness (anergy) or death via apoptosis.
- Signal 1 is provided by the low-affinity cognate TCR–MHC plus peptide interaction.
- The second co-stimulatory signal (signal 2) is mediated through ligation of CD28 by B7 (CD80/CD86) and greatly amplifies signals generated through TCR–MHC interactions.

- Previously stimulated T-cells require only one signal, through their TCRs, for efficient activation.

T-cell receptor activation

- The TCR does not possess any intrinsic enzymatic activity but is associated with accessory proteins (the CD3 co-receptor complex) that can recruit protein tyrosine kinases (PTKs).
- The TCR signal is transduced and amplified through a protein tyrosine kinase enzymic cascade.
- Recruitment of CD4 or CD8 to the TCR complex leads to phosphorylation of ITAM sequences on CD3-associated ζ chains by the CD4-associated Lck PTK. The phosphorylated ITAMs bind and then activate the ZAP-70 kinase.

Downstream events following TCR signaling

- Non-enzymic adaptor proteins form multimeric complexes with kinases and guanine nucleotide exchange factors (GEFs).
- Hydrolysis of phosphatidylinositol diphosphate by phospholipase $C\gamma 1$ or $C\gamma 2$ produces inositol trisphosphate (IP_3) and diacylglycerol (DAG).
- IP_3 mobilizes intracellular calcium.
- DAG and increased calcium activate protein kinase C.
- The raised calcium together with calmodulin also stimulates calcineurin activity.
- Activation of Ras by the guanine nucleotide exchange factor Sos sets off a kinase cascade operating through Raf, the MAP kinase kinase MEK and the MAP kinase ERK. CD28 through PI3 kinase can also influence MAP kinase.
- The transcription factors Fos and Jun, NFAT, and NF κ B are activated by MAP kinase, calcineurin, and PKC, respectively, and bind to regulatory sites in the IL-2 promoter region.
- Integrated signals from the TCR, CD28, and exogenous cytokines, drive gene specific expression programs that synchronize T cell activation and differentiation.
- Differentiation of activated T-cells is controlled by the expression of different master regulators of transcription.
- Gene expression controlling T-cell activation and differentiation is under strong epigenetic control.
- A small number of MHC-peptide complexes can serially trigger a much larger number of TCRs thereby providing the sustained signal required for activation.
- Initial binding of integrins facilitates the formation of an immunological synapse, the core of which exchanges integrins for TCR interacting with MHC-peptide.

- Inhibitory co-receptor CTLA-4 is an important regulator of T-cell activation.
- PD-1-mediated T-cell inhibition facilitates tumor growth.
- Cbl family adaptor molecules are involved in negative signaling pathways.
- The phosphatase domains on CD45 are required to remove phosphates at inhibitory sites on kinases.

Activated T-cells undergo an essential metabolic shift

- Naive T-cells generate ATP through OXPHOS, whereas activated effector T-cells switch to using aerobic glycolysis to generate metabolites and to aid proliferation and cytokine production.
- Signals from the TCR, CD28, and cytokines drive specific metabolic programs.
- Particular metabolic programs are required for T-cell differentiation into effector subsets.

B-cells respond to three different types of antigen

- Type 1 thymus-independent antigens are polyclonal activators focused onto the specific B-cells by sIg receptors.
- Type 2 thymus-independent antigens are polymeric molecules that cross-link many sIg receptors and, because of their long half-lives, provide a persistent signal to the B-cell.
- Thymus-dependent antigens require the cooperation of helper T-cells to stimulate antibody production by B-cells.
- Antigen captured by specific sIg receptors is taken into the B-cell, processed, and expressed on the surface as a peptide in association with MHC class II.
- This complex is recognized by the T-helper cell that activates the resting B-cell.
- The ability of protein carriers to enable the antibody response to haptens is explained by T-cell-B-cell collaboration, with T-cells recognizing the carrier and B-cells the hapten.

The nature of B-cell activation

- Cross-linking of surface Ig receptors (e.g., by type 2 thymus-independent antigens) activates B-cells.
- T-helper cells activate resting B-cells through TCR recognition of MHC II-carrier peptide complexes and co-stimulation through CD40L-CD40 interactions (analogous to the B7-CD28 second signal for T-cell activation).
- B-cell co-stimulation is also provided by the B-cell co-receptor complex consisting of CD19, CD21, CD81, and LEU13.
- B-cell receptors (BCRs) also form immunological synapses composed of numerous BCR microclusters and integrins.



Now visit www.roitt.com to test yourself on this chapter.

FURTHER READING

- Abraham R.T. and Weiss A. (2004) Jurkat T-cells and development of the T-cell receptor signalling paradigm. *Nature Reviews Immunology* **4**, 301–308.
- Acuto O. and Michel F. (2003) CD28-mediated costimulation: a quantitative support for TCR signalling. *Nature Reviews Immunology* **3**, 939–951.
- Batista F.D. and Harwood N.E. (2009) The who, how and where of antigen presentation to B-cells. *Nature Reviews Immunology* **9**, 15–27.
- Buday L. and Downward J. (2008) Many faces of Ras activation. *Biochimica Biophysica Acta* **1786**, 178–187.
- Chang J.T., Wherry E.J., and Goldrath A.W. (2014) Molecular regulation of effector and memory T-cell differentiation. *Nature Immunology* **15**, 1104–1115.
- Dustin M.L. and Depoli D. (2011) New insights into the T-cell synapse by single molecule techniques. *Nature Reviews Immunology* **11**, 672–684.
- Fooksman D.R., Vardhana S., Vasiliver-Shamis G., *et al.* (2010) Functional anatomy of T-cell activation and synapse formation. *Annual Review of Immunology* **28**, 1–27.
- Harwood N.E. and Batista F.D. (2010) Early events in B-cell activation. *Annual Review of Immunology* **28**, 185–210.
- Huang F. and Gu H. (2008) Negative regulation of lymphocyte development and function by the Cbl family of proteins. *Immunological Reviews* **224**, 229–238.
- Iwasaki A. and Medzhitov R. (2015) Control of adaptive immunity by the innate immune system. *Nature Immunology* **19**, 343–353.
- Jenkins M.K., Khoruts A., Ingulli E., *et al.* (2001) *In vivo* activation of antigen-specific CD4 T-cells. *Annual Review of Immunology* **19**, 23–45.
- Kinashi T. (2005) Intracellular signaling controlling integrin activation in lymphocytes. *Nature Reviews Immunology* **5**, 546–559.
- Kurosaki T. (2002) Regulation of B-cell signal transduction by adaptor proteins. *Nature Reviews Immunology* **2**, 354–363.
- Mueller D.L. (2010) Mechanisms maintaining peripheral tolerance. *Nature Immunology* **11**, 21–27.
- MacIver N.J., Michalek R.D., and Rathmell J.C. (2013) Metabolic regulation of T lymphocytes. *Annual Review of Immunology* **31**, 259–283.
- Nihiro H. and Clark E.A. (2002) Regulation of B-cell fate by antigen-receptor signals. *Nature Reviews Immunology* **2**, 945–956.
- Nutt, S.L., Hodgkin P.D., Tarlinton D.M., and Corcoran L.M. (2012) The generation of antibody-secreting plasma cells. *Nature Reviews Immunology* **160**, 160–172.
- Okazaki T., Chikuma S., Iwai Y., Fagarasan S., and Honjo T. (2013) A rheostat for immune responses: the unique properties of PD-1 and their advantages for clinical application. *Nature Immunology* **12**, 1212–1218.
- Rudd C.E., Taylor A., and Schneider H. (2009) CD28 and CTLA-4 coreceptor expression and signal transduction. *Immunological Reviews* **229**, 12–26.
- Smith-Garvin J.E., Koretzky G.A., and Jordan M.S. (2009) T-cell activation. *Annual Review of Immunology* **27**, 591–619.
- Yokosuka T. and Saito T. (2009) Dynamic regulation of T-cell costimulation through TCR–CD28 microclusters. *Immunological Reviews* **229**, 27–40.

CHAPTER 8

The production of effectors

Key topics

- Effector mechanisms of innate and adaptive immunity 220
- Cytokines influence the generation and function of effectors within the adaptive immune system 223
- Cytokines act as intercellular messengers 224
- Chemokines also play important roles in orchestrating immune responses 229
- Cytokines and chemokines act through distinct classes of cell surface receptors 234
- Cytokine receptor signal transduction cascades 234
- Cytokine activities are fine-tuned through a variety of mechanisms 240
- Activated T-cells proliferate in response to cytokines 242
- Different T-cell subsets can make different cytokine patterns 243
- Cells of the innate immune system shape the Th1/Th2/Th17/Tfh response 247
- Policing the adaptive immune system 248
- CD8⁺ T-cell effectors in cell-mediated immunity 251
- Proliferation and maturation of B-cell responses are mediated by cytokines 255
- What is going on in the germinal center? 256
- The synthesis of antibody 258
- Immunoglobulin class switching occurs in individual B-cells 258
- Factors affecting antibody affinity in the immune response 261
- Memory cells 262

Roitt's Essential Immunology, Thirteenth Edition. Peter J. Delves, Seamus J. Martin, Dennis R. Burton, and Ivan M. Roitt.
 © 2017 John Wiley & Sons, Ltd. Published 2017 by John Wiley & Sons, Ltd.
 Companion website: www.roitt.com

Just to recap ...

The adaptive immune response works in tandem with an ongoing innate immune response and, as we shall see, **amplifies and reinforces the innate immune response through the provision of cytokines, antibodies, and cytotoxic T-cells capable of executing virally infected cells**. Activated T-cells differentiate into **effector cells** capable of secreting diverse patterns of cytokines or cytotoxic molecules; similarly, activated B-cells differentiate into plasma cells capable of secreting different antibody classes. Cells of the innate immune system in general, and DCs in particular, play a key role in shaping the particular flavor of adaptive immune response that is mounted in response to antigenic stimulation. This is achieved **through the secretion of different patterns of cytokines** in response to the initial infection. These cytokines, in turn, influence the nature of the T- and B-cell effectors that are produced. Cytokines can also stimulate production of additional innate immune cells, such as macrophages and neutrophils, can increase the production of acute phase proteins, and promote dilation of local blood vessels to facilitate migration of immune cells to the site of infection.

As the reader will hopefully recall from earlier chapters, **cytokines are soluble cell–cell communication molecules** that enable cells of the immune system to “talk” to other immune cells, instructing the recipients of these signals to switch on particular functions. Cytokines that are important for the initiation and/or amplification of immune responses can also be released from barrier tissues, such as skin keratinocytes or intestinal epithelium, thus enabling these nonimmune cells to

play a role in the initiation and shaping of immune responses. We shall now look at the various classes of cytokines that are important within the immune system, how their production is regulated, how they convey their messages intracellularly, and how the various cytokines and cytokine combinations influence the various effector functions of the T- and B-lymphocytes of the adaptive immune system.

Introduction

Recall from Chapter 1 that **immune responses are instigated by two major classes of stimuli, pathogen-associated molecular patterns (PAMPs) and danger-associated molecular patterns (DAMPs)**, which are encountered by cells of the innate immune system either due to infection (PAMPs) or injury (DAMPs). As the astute reader will know well by now, PAMPs engage the various classes of pattern recognition receptor (TLRs, RLRs, NLRs, and so on) present on macrophages and dendritic cells (DCs), the activation of which will instigate the production of cytokines and chemokines that collaborate to get an inflammatory response up and running (Figure 8.1). As we also learned in Chapter 1, the nature of the infectious agent (whether viral, bacterial, or yeast, etc.) as well as the site of detection (extracellular, intracellular) will dictate the repertoire of PAMP receptors that are engaged in response to a particular infection. Thus, the **cells of the innate immune system decode the type of infection that they are dealing with through its unique PAMP signature**. The combined outputs of the PAMP receptors that are engaged, in addition to inputs from the surrounding tissue, will produce

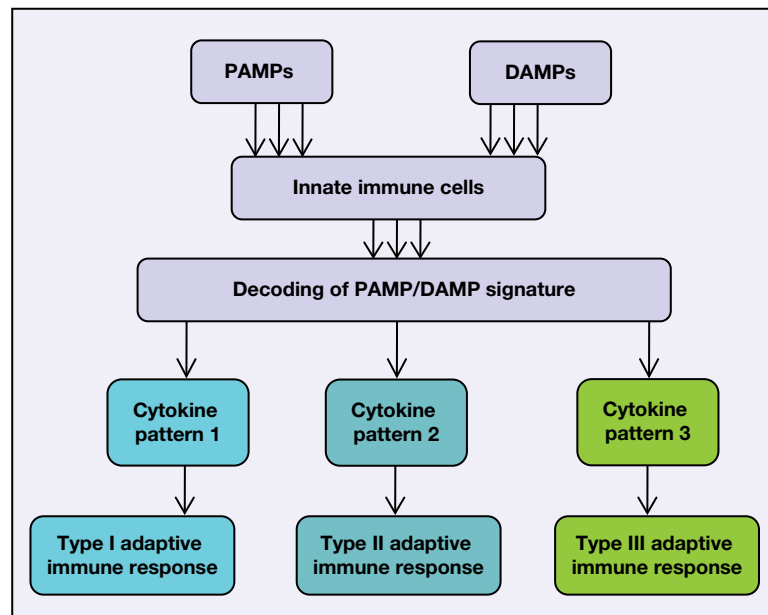


Figure 8.1 Cells of the innate immune system shape adaptive immunity through sensing PAMPs and DAMPs. Individual PAMP/DAMP combinations are sensed by DCs (using a battery of PRRs and specific receptors for DAMPs) as well as other cells of the innate immune system (such as macrophages, mast cells, granulocytes) and are then translated into unique cytokine signatures that elicit the appropriate T- and B-cell effector responses downstream.

a distinct cytokine pattern (Figure 8.1). This sets the ball rolling in terms of tailoring the innate as well as the subsequent adaptive immune response towards what is most useful for a particular infectious agent. The input from the surrounding tissue (in the form of cytokines as well as molecules that can influence DC and macrophage function) will also help to tailor the response towards what is best for that particular tissue. As we shall see, lots of DC-derived IL-12 and IFN γ will elicit CTLs and other T-cells that produce cytokines (such as IFN γ and TNF) useful for clearance of intracellular viral and bacterial infections; IL-4 from locally activated mast cells or basophils will elicit T-cells specialized in giving help for production of B-cell-derived antibodies for clearance of extracellular bacterial infections and large worm parasites; in contrast, the combination of IL-6/TGF β ultimately produces Th17 cells adept at secreting cytokines to promote neutrophil recruitment for dealing with bacterial infections in the skin and mucosal surfaces.

In the absence of infection, cell death, leading to the release of DAMPs from the local tissue, initiates the process of sterile inflammation, which is more concerned with wound healing rather than dealing with infectious agents. Members of the extended IL-1 family (which includes IL-1 α , IL-1 β , IL-18, IL-33, and three IL-36 cytokines) represent the best examples of DAMPs that we know of, as these are all leaderless cytokines that are only released upon triggering necrosis. As we shall see, another class of T-cells, called Tregs, can directly respond to DAMPs by promoting the production of wound-healing cytokines, such as amphiregulin, which promotes proliferation of local cells to replace tissue lost through injury. Macrophages and other cell types, such as fibroblasts, also respond to DAMPs to promote wound healing.

Of course infection also frequently leads to tissue injury. Thus DAMPs released through necrosis in the context of an infection will frequently combine with the pathogen-associated PAMPs to amplify and shape the PAMP-driven cytokine signature (Figure 8.1).

Thus, ***unique combinations of PAMPs and DAMPs fine-tune the nature of the effector responses that are generated by the adaptive immune system.*** These PAMP/DAMP combinations are translated into ***unique cytokine signatures that elicit the appropriate T- and B-cell effector responses*** downstream. As we shall see throughout this chapter, ***particular cytokine combinations trigger the differentiation of T- and B-cell populations into distinct effector classes.***

Effector mechanisms of innate and adaptive immunity

The innate immune system utilizes a number of different effector mechanisms to combat infection

In Chapter 1 we learned that ***the innate immune system uses a variety of strategies*** to deal with microorganisms that have successfully breached the physical barriers of the skin and mucosal surfaces. The first line of defense involves the cells and

soluble factors of the innate immune system that take immediate action upon detection of nonself in the form of PAMPs. The steps taken by the innate immune system in dealing with a nascent infection include ***direct binding of soluble pattern recognition receptors (PRRs)***, such as complement, lysozyme, antimicrobial peptides, and mannose-binding lectin, to orchestrate immediate destruction of a pathogen or to enhance ***phagocytic uptake by macrophages and neutrophils***. Macrophages and neutrophils also directly recognize and engulf pathogens via their cell-associated pattern recognition receptors. As we also learned in Chapter 1, neutrophils can release their cytotoxic enzymes into the extracellular space through ***degranulation***, and can even deploy their chromatin as ***extracellular traps*** for microorganisms, attacking and killing infectious agents through destructive proteases and carbohydrases.

Other options at the disposal of the innate immune system involve the ***deployment of mast cells and basophils***, both of which use their granule enzymes to combat large extracellular parasites. Let us also not forget ***natural killer (NK) cells that are adept at killing host cells displaying signs of viral infection*** or other evidence of trouble within. As we shall see later in this chapter, NK cells may also use their granule proteases to attack intracellular and extracellular bacteria via a slightly modified delivery system for these enzymes. We also discussed the role of ***DCs as sentinels of the innate immune system***, serving to alert T-cells to an ongoing infection by presenting antigen within the context of appropriate co-stimulatory signals (i.e., ligands of the B7 family). To summarize these effector mechanisms, the innate immune system can utilize one or more of the following strategies:

- Direct lysis of pathogens via soluble PRRs (e.g., complement, antimicrobial peptides)
- Opsonization of pathogens by soluble PRRs followed by phagocytosis
- Direct phagocytosis of pathogens via cell-associated PRRs
- Destruction of microbes and large parasites through release of granulocyte (i.e., neutrophil, basophil, eosinophil) and mast cell enzymes into the extracellular space
- Deployment of extracellular chromatin traps by granulocytes and macrophages
- NK cell-mediated attack of infected cells or extracellular bacteria
- DC and macrophage-mediated production of chemokines and cytokines to coordinate immune responses
- DC and macrophage-mediated antigen presentation and co-stimulation of T-cells to promote adaptive immunity.

All told, the innate immune system has a truly impressive armory of highly effective weapons that can be deployed in pursuit of defending the body against infection. Nonetheless, the innate immune system frequently requires assistance to deal with well-adapted pathogens that have evolved an equally impressive array of immune evasion strategies to frustrate all of the above efforts. The cavalry comes in the form of the adaptive immune response.

The innate immune system plays a critical role in triggering and shaping the effector mechanisms deployed by the adaptive immune system

Although the hard-wired pattern recognition receptors (PRRs) used by the innate immune system to detect PAMPs are highly reliable in terms of discriminating self from nonself, they lack the specificity required to home in on a pathogen that has managed to survive the initial onslaught. For the most part, the effector mechanisms of the innate immune system also lack memory of previous encounters with regular visitors (although recent discoveries suggest that innate immunity does have some capacity for memory) and have to start from scratch each time a new infection occurs. Because the adaptive immune system uses receptors (i.e., T-cell receptors and antibodies) that are generated de novo through random genetic recombination in response to each infectious agent, these receptors can be exquisitely tailored to recognize essentially any pathogen. Moreover, stockpiles of particularly useful T- and B-cells can also be generated through clonal expansion and maintained for many years as memory cells. The latter cells can be deployed rapidly when regular guests come calling, giving a considerable advantage over an unsuspecting pathogen. However, there is a very troublesome fly in the immune ointment that cannot be overlooked. Because the

gene shuffling mechanism used to generate diversity among TCRs and BCRs can all too easily end up recognizing self (thereby triggering autoimmunity), the cells of the adaptive immune system require instruction by cells of the innate system as to whether an immune response should be mounted towards a particular antigen (or not). This is a critical role of the innate immune system and its importance cannot be overstated. What qualifies an antigen as nonself to a T- or B-lymphocyte, and therefore safe to attack, is its presentation in the context of co-stimulation, which requires the detection of PAMPs by cells (predominantly DCs) of the innate immune system. Thus, cells of the innate immune system, in effect, give permission to cells of the adaptive immune system to respond to antigen.

Furthermore, as we have noted earlier, *the precise nature of the PRRs that are engaged on cells of the innate immune system in the initial stages of an infection dictate the type of adaptive immune response that is warranted* (i.e., whether dominated by antibody-producing B-cells, or alternatively, by CTLs that kill intracellular viruses and transformed cells). This is achieved through the production of specific cytokines and chemokines during the priming phase of an adaptive immune response, the influence of which instructs the correct type of adaptive immune response (Figure 8.2).

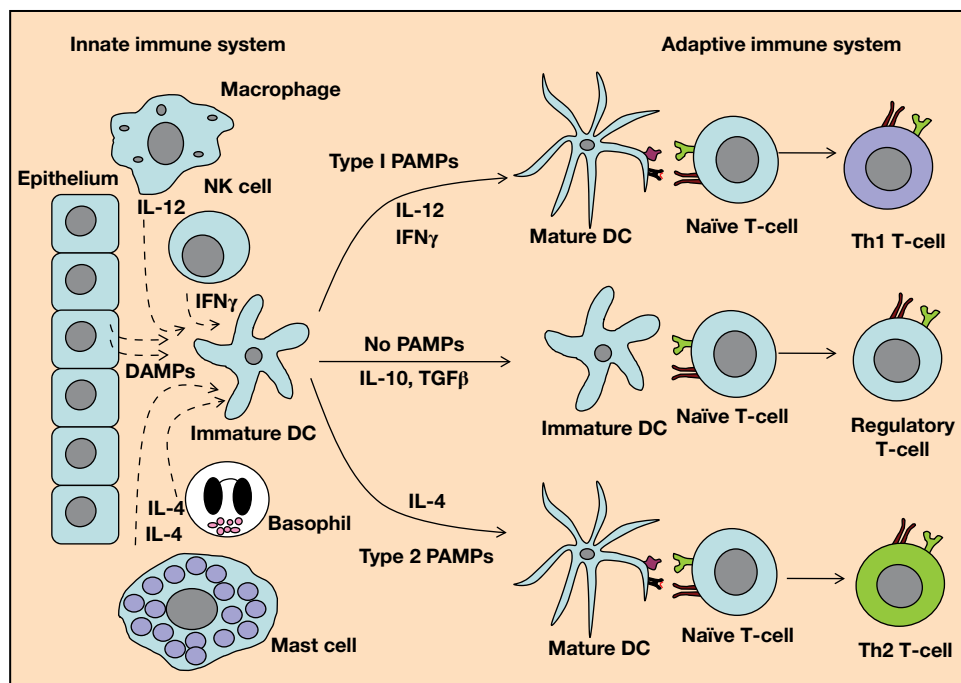


Figure 8.2 Dendritic cell (DC) polarization is influenced by the nature of the infectious agent (i.e., PAMPs) as well as the tissue location. DC polarization is influenced by the type of microorganism that is recognized and the site of activation. Immature DCs can be polarized by type 1, type 2, and regulatory-type pathogen-associated molecular patterns (PAMPs) or tissue factors to become mature effector DCs that promote the development of naive T-cells into different classes of effector T-cells. Note that the designation of PAMPs as type 1 and type 2 is not exhaustive as DCs will tailor their cytokine output towards the specific PAMP/DAMP combination detected.

Adaptive immunity also employs a range of effector mechanisms

Just as the innate immune system employs a range of strategies to subdue infectious agents (see Chapter 1), the adaptive immune system, made up of T- and B-lymphocytes, also has a number of weapons at its disposal. In Chapter 2 we discussed the role of B-cell-derived antibodies as a means of coating microorganisms for the purposes of enhancing complement-mediated lysis via the classical pathway, or enhancing their uptake by phagocytosis via specific Fc receptors on macrophages and neutrophils, or indeed by simply aggregating infectious agents and impeding their further incursion into tissues. Antibodies can also be used to the advantage of NK cells to focus their cytotoxic actions via antibody-dependent cellular cytotoxicity (ADCC). T-cells also employ a range of strategies to defend the body from infectious agents (Figure 8.3). Recall that T-cells can be grouped into two major subdivisions: helper (Th) and cytotoxic (Tc or CTL) T-cells, that are selected to recognize antigen presented in the context of MHC class II or MHC class I molecules, respectively. Whereas T-helper cells function to help B-cells make antibodies or to activate the killing function of macrophages or NK cells, Tc cells are endowed with the ability to engage and kill virally infected cells. As we shall discuss in more detail in this chapter, *T-helper cells can*

be further subdivided into Th1, Th2, Th17, and Tfh cells on the basis of the cytokine profiles that these cells secrete, as this confers different effector functions on such cells. We shall also discuss other subdivisions of T-cells (*regulatory T-cells [Tregs]*), that also differ in the cytokine profile produced, as these cells serve important regulatory functions and help to safeguard the body against inappropriate T-cell responses that are directed against self, as well as excessive or inappropriate responses directed towards nonself.

So, to recap, adaptive immunity can involve one or more of the following responses:

- Antibody-mediated aggregation of pathogens, thereby impeding tissue invasion
- Antibody-mediated opsonization of pathogens, followed by phagocytosis
- Antibody-mediated opsonization of pathogens, followed by complement activation
- Enhancement of NK-mediated killing via ADCC
- T-cell-mediated killing of virally infected cells
- T-cell-mediated killing of transformed cells
- Production of cytokines by T-cells to enhance macrophage killing
- Production of cytokines by T-cells to promote granulocyte recruitment

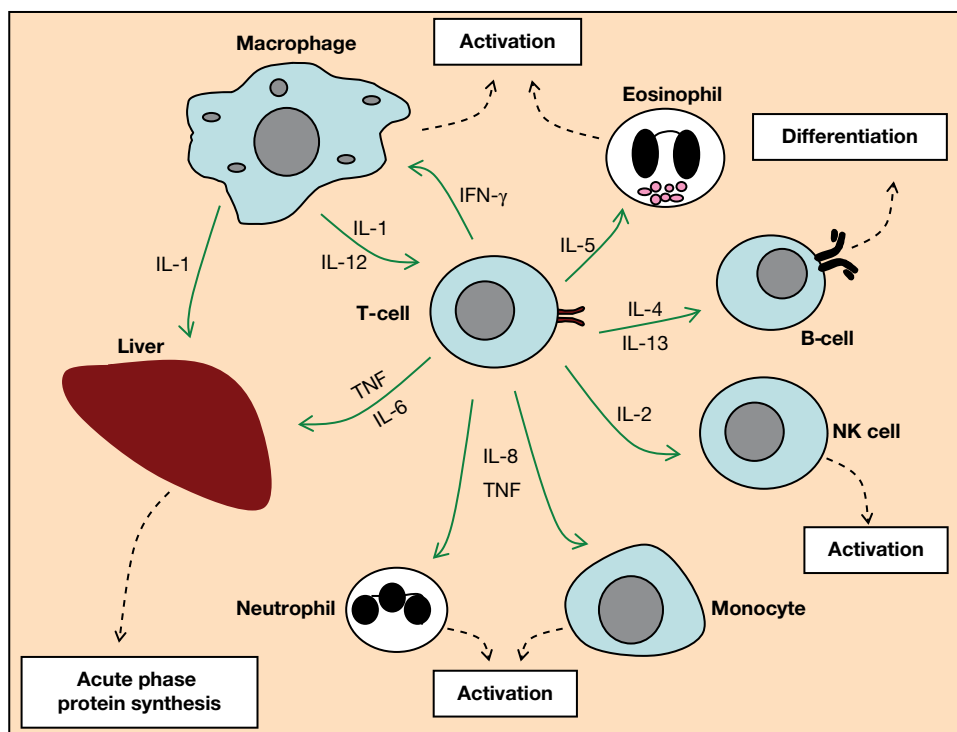


Figure 8.3 T-cells can regulate diverse elements of the immune system through the production of different cytokines. This illustrates some, but by no means all, of the interactions that activated T-cells can have with other elements of the immune system through the directed secretion of specific cytokines. Note that not all T-cells are capable of secreting all of the cytokines indicated. Rather, specific T-cell subsets are generated that are skewed towards secretion of particular subsets of the cytokines shown.

- Production of cytokines by T-cells to promote antibody production by B-cells
- Production of cytokines by T-cells to promote wound healing.

Cytokines influence the generation and function of effectors within the adaptive immune system

As noted above, the production of various cytokines in response to the detection of pathogens by the innate immune system is central to both the maturation as well as the specific effector functions of B- and T-cells. We have already referred to the diverse roles of cytokines throughout the previous chapters and have alluded to their properties as *messenger molecules that enable the disparate elements of the immune system to communicate with each other and also to trigger differentiation to particular effector cell types*. Communication between cells of the innate and adaptive immune system underpins the amplification of immune responses (Figure 8.1 and Figure 8.2), and is also instrumental in marshalling the appropriate response (i.e., whether predominantly antibody-mediated or cell-mediated) depending on the nature of the infectious agent as well as its route of entry into the body. Here, we will go into more detail concerning the different categories of cytokines, how these molecules act upon their target cells, and the spectrum of responses they initiate. All of these issues are central to how the effector cells of the adaptive immune system are generated and the nature of the responses they engage in. Whereas many of the elements of the innate immune system are poised to strike with little delay upon detection of a PAMP, *the actions of T- and B-lymphocytes are heavily influenced by the cytokine environment accompanying their initial exposure to specific antigen*.

Dendritic cells and other cells of the innate immune system play a central role in the generation of effectors

A major influence on the type of effector cells generated in response to a pathogenic challenge is wielded by dendritic cells, which, in addition to presenting antigen (signal 1) and providing co-stimulatory signals (signal 2) to T-cells, also exert significant control over the type of T-cell response that is generated. *DCs achieve this by providing additional input in the form of cytokines (signal 3)* that shape the nature of the effector T-cells that are thus generated (Figure 8.4). The particular cocktail of cytokines elaborated by DCs during the initial round of T-cell stimulation in a lymph node influences whether the response will be dominated by the generation of T-cell effectors that provide help for B-cells (Th2), or alternatively, result in the generation of T-cells that activate macrophages and assist CTL function (Th1 cells). The generation of other Th subsets (e.g., Th17 cells, Tfh cells), characterized by particular patterns of cytokines, has also been recognized.

The pattern of cytokines secreted by differentiated effector T-cells can be further influenced by local macrophages, mast cells, NK cells, basophils and other cells of the innate immune system encountered by activated T-cells that migrate to sites of infection. Once again, this is through the provision of cytokines that trigger or reinforce the development of different T-cell effector subsets.

As we noted earlier, it is the nature of the PAMPs and DAMPs that propel DCs into action in the first place, as well as cytokines elaborated by the other cells of the innate immune system upon encountering an infectious agent, that influence the cytokine profile adopted by an activated DC (Figure 8.1 and Figure 8.2). Recall from Chapter 1 that the *innate immune system effectively decodes the type of infectious agent* that is encountered (whether it is bacterial, viral, fungal, or parasitic) through detection of the unique combination of PAMPs associated with the intruder, and also conveys important

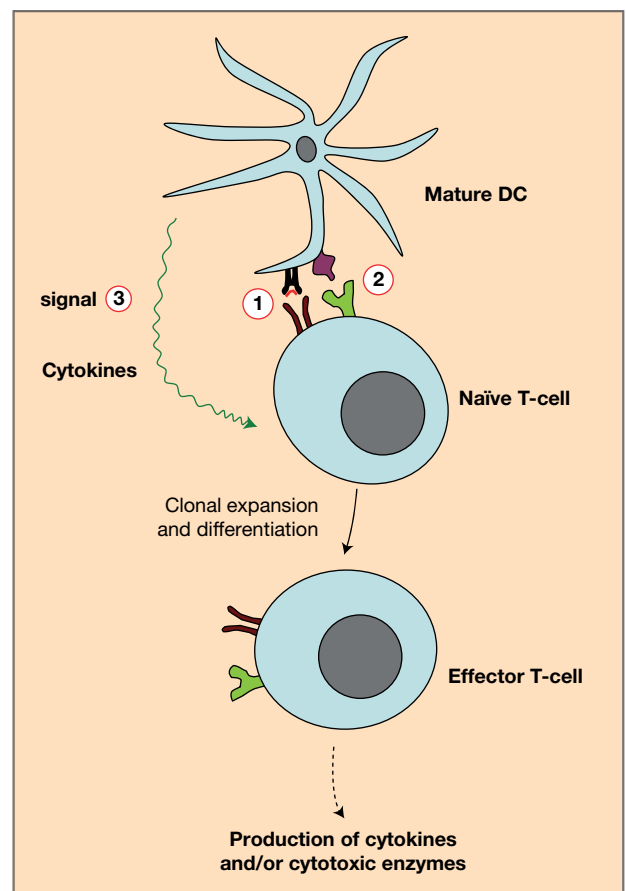


Figure 8.4 Generation of effector T-cells is influenced by the cytokine environment experienced by the T-cell at the point of initial activation. MHC–peptide recognition by the TCR represents signal 1, co-stimulation of CD28 by B7 ligands represents signal 2, and cytokines produced by the DC represents signal 3. Note that the cytokine environment upon re-stimulation of a T-cell within an infected tissue will also influence the nature of the effector response made by the T-cell.

information concerning the site of infection (whether intracellular or extracellular). **This information is translated, via the actions of the multiplicity of pattern recognition receptors, into a unique cytokine signature** that is instrumental in shaping the type of immune response that is initiated to deal with the particular infection.

Macrophages can undergo polarization into different subpopulations that make different cytokine combinations

There is much evidence that macrophages, which are highly abundant in most tissues as we discussed in Chapter 1, can also undergo polarization to express distinct cytokine combinations. At a minimum, two major macrophage populations have been identified, designated M1 (or classically activated) and M2 (or alternatively activated) macrophages. M1 macrophages are generated under the influence of $\text{IFN}\gamma$ or microbial PAMPs and exhibit antimicrobial proinflammatory properties through production of high levels of $\text{TNF}\alpha$, IL-1, IL-6, IL-12, and IL-23 among other cytokines. M1 macrophages also exhibit high surface expression of MHC class II molecules. In contrast, M2 macrophages express low levels of MHC class II and IL-12 and are generated under the influence of IL-4, IL-10, or IL-13 and favor a more anti-inflammatory, wound-healing-type response through production of IL-10 and arginase (which antagonizes T-cell proliferation through depletion of local arginine) among other factors. The presence of polarized macrophages populations within tissues can skew adaptive immune responses towards eliciting T-cell populations that favor cytotoxic T-cell responses, or those that give help for B-cell-mediated production of IgE, or through suppressing the development of such responses.

However, it really cannot be overemphasized that the separation of macrophages into sharply defined M1/M2

subsets is a gross oversimplification. The real situation is much more akin to a color palette, with each shade of the color spectrum representing distinct macrophage types expressing distinct subsets of cytokines, chemokines, antimicrobial peptides, and other effector molecules. Macrophage populations are highly diverse and there is a growing body of evidence to suggest that this diversity is underpinned by the unique tissue environment experience by individual macrophages. As a consequence, there are large differences between the phenotypes and functional properties of macrophages from different tissues, such as Kupffer cells in the liver, alveolar macrophages of the lung, peritoneal macrophages, microglial cells in the brain, and so on. The nature of the factors that trigger macrophage polarization are only now being identified, but retinoic acid, tissue osmolarity, prostaglandins, and lactic acid are some of the factors that have been shown to activate distinct transcription factor programs that promote macrophage polarization.

Before we discuss the various T- and B-lymphocyte effector cell types, let us now take a closer look at the diversity of the cytokine family and how these important cell–cell communication molecules exert their effects at a molecular level.

Cytokines act as intercellular messengers

Cytokines are structurally diverse polypeptides that function as **messenger molecules** that can communicate signals from one cell type to another and, among other things, they can instruct the cell receiving the signal to proliferate, differentiate, secrete additional cytokines, migrate, or die (Figure 8.5). Cytokines signal via plasma membrane-borne receptors, to which they bind with very high affinity, and generally show very high specificity towards their receptors. As a result of the very high affinity for their cognate receptors, cytokines are frequently biologically active at very low concentrations, typically in the nanomolar (10^{-9}) or even picomolar (10^{-12}) range. Cytokines send instructions

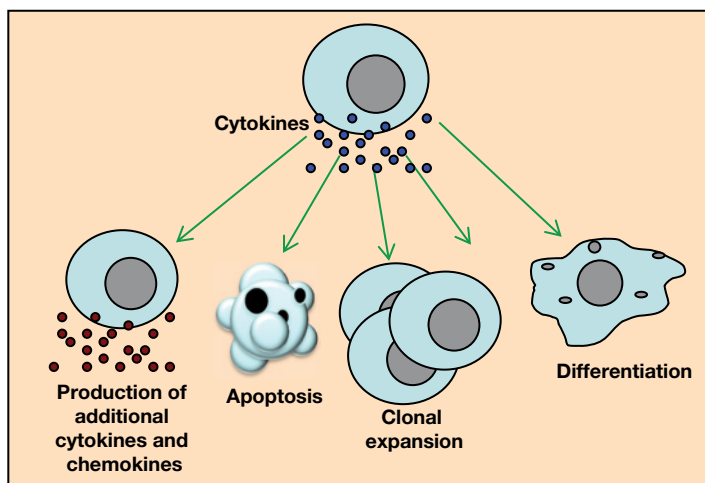


Figure 8.5 Cytokines can have multiple biological effects. Cytokines can promote cell division, can trigger the production of additional cytokines, chemokines, and antimicrobial peptides; others can promote cell death or cell differentiation. Cytokines also exhibit pleiotropic effects, eliciting one response in a specific cell type and a completely different response in another.

between cells, to switch on, or off, specific effector functions or to initiate the process of differentiation from one cell state to another. In most cases, *this is achieved through initiating the transcription of a new cohort of genes within the cell, the products of which endow the cell with new or enhanced capabilities* (Figure 8.6). For example, IL-2 triggers a transcriptional program within T-cells that enables these cells to proliferate upon receipt of this signal, whereas TNF induces the transcriptional upregulation of well over 50 different cytokines, chemokines, antibacterial proteins/peptides as well as other immune response molecules within responsive target cells. TNF can also trigger activation of neutrophils and local endothelium to upregulate integrins that facilitate extravasation of immune cells and plasma proteins (containing complement and other acute phase reactants) into tissues.

To date, many different cytokines have been described and no doubt some remain to be discovered (Table 8.1). One of the most important cytokine groupings, to the immunologist's way of thinking, is the interleukin family as this contains cytokines that act as communicators between leukocytes. Members of the interleukin family are very diverse, belonging to different protein structural classes (Figure 8.7), because the primary qualification for membership of this family is biological (i.e., evidence of activity on leukocytes) rather than sequence or structural homology. Indeed, although additional homologs of the interleukin family are known, their status as interleukins awaits evidence that these proteins exert functional effects

upon leukocytes. Approximately 37 interleukins have been described to date (IL-1 to IL-38).

Other cytokine families have been established on the basis of their ability to support proliferation of hematopoietic precursors (colony-stimulating factors), or cytotoxic activity towards transformed cell types (tumor necrosis factors), or the ability to interfere with viral replication (interferons). It is important to note, however, that *cytokines frequently have pleiotropic effects*, doing much more than their somewhat descriptive (and often misleading) names would suggest. Indeed, the response that many of these molecules elicit depends, to a large extent, on the context in which the cytokine signal is delivered (i.e., whether the cell is receiving concurrent signals from other cytokines and/or PAMPs), as well as the cell type receiving the signal. Other factors, such as the differentiation stage of the cell, its position within the cell cycle (whether quiescent or proliferating), and the simultaneous presence of other cytokines, can all influence the response made to a particular cytokine.

Cytokine action is transient and usually short range

Cytokines are typically low molecular weight (15–25 kDa) secreted proteins that mediate cell division, inflammation, cytotoxicity, differentiation, migration, and repair. Because they regulate the amplitude and duration of the immune-inflammatory responses, cytokines must be produced in a

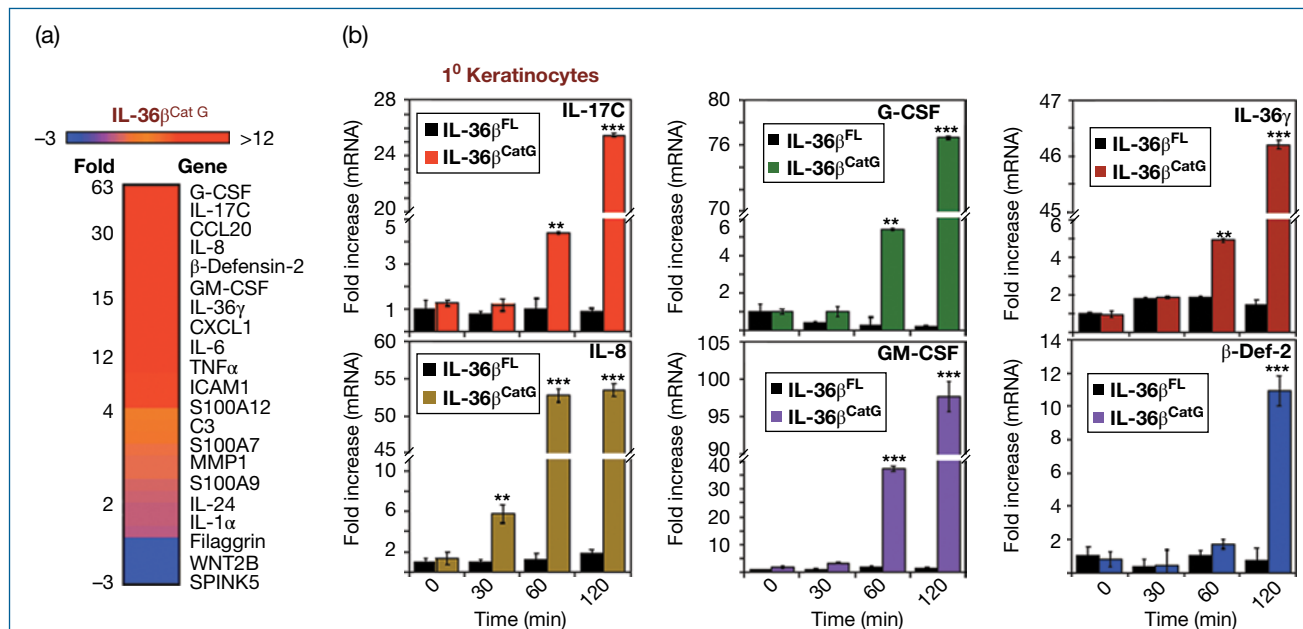


Figure 8.6 Cytokines can trigger batteries of new gene expression. Apical or upstream cytokines, such as TNF or members of the extended IL-1 family, can promote the expression of dozens or hundreds of new gene expression events, many of which encode other cytokines, chemokines, antimicrobial peptides, proteins, and complement factors. In this example, primary human keratinocytes have been treated with the IL-1 family member IL-36β, followed by analysis of (a) genes upregulated in response to this cytokine by gene expression array analysis and (b) quantitation of cytokine production by ELISA. (Source: Henry C.M. *et al.* (2016) *Cell Reports* 14, 708–722. Reproduced with permission of Elsevier.)

Table 8.1 Cytokines: their origin and function.

Cytokine	Source	Effector function
Interleukins		
IL-1 α , IL-1 β	Mono, M ϕ , DC, NK, B, Endo	Co-stimulates T activation by enhancing production of cytokines including IL-2 and its receptor; enhances B proliferation and maturation; NK cytotoxicity; induces IL-1, IL-6, IL-8, TNF, GM-CSF, and PGE ₂ by M ϕ ; proinflammatory by inducing chemokines and ICAM-1 and VCAM-1 on endothelium; induces fever, APP, bone resorption by osteoclasts
IL-2	Th1	Induces proliferation of activated T-and B-cells; enhances NK cytotoxicity and killing of tumor cells and bacteria by monocytes and M ϕ
IL-3	T, NK, MC	Growth and differentiation of hematopoietic precursors; MC growth
IL-4	Th2, Tc2, NK, NKT, $\gamma\delta$ T, MC	Induces Th2 cells; stimulates proliferation of activated B, T, MC; upregulates MHC class II on B and M ϕ , and CD23 on B; downregulates IL-12 production and thereby inhibits Th1 differentiation; increases M ϕ phagocytosis; induces switch to IgG1 and IgE
IL-5	Th2, MC	Induces proliferation of Eosino and activated B; induces switch to IgA
IL-6	Th2, Mono, M ϕ , DC, BM stroma	Differentiation of myeloid stem cells and of B into plasma cells; induces APP; enhances T proliferation. Important for Th17 and Tfh polarization
IL-7	BM and thymic stroma	Induces differentiation of lymphoid stem cells into progenitor T and B; activates mature T cells
IL-8/CXCL8	Mono, M ϕ , Endo	Mediates chemotaxis and activation of Neutro
IL-9	Th	Induces proliferation of thymocytes; enhances MC growth; synergizes with IL-4 in switch to IgG1 and IgE
IL-10	Th (Th2 in mouse), Tc, B, Mono, M ϕ	Inhibits IFN γ secretion by mouse, and IL-2 by human, Th1 cells; downregulates MHC class II and cytokine (including IL-12) production by Mono, M ϕ , and DC, thereby inhibiting Th1 differentiation; inhibits T proliferation; enhances B differentiation
IL-11	BM stroma	Promotes differentiation of pro-B and megakaryocytes; induces APP
IL-12	Mono, M ϕ , DC, B	Critical cytokine for Th1 differentiation; induces proliferation and IFN γ production by Th1, CD8 ⁺ and $\gamma\delta$ T and NK; enhances NK and CD8 ⁺ T cytotoxicity
IL-13	Th2, MC	Inhibits activation and cytokine secretion by M ϕ ; co-activates B proliferation; upregulates MHC class II and CD23 on B and Mono; induces switch to IgG1 and IgE; induces VCAM-1 on Endo
IL-15	T, NK, Mono, M ϕ , DC, B	Induces proliferation of T-, NK and activated B and cytokine production and cytotoxicity in NK and CD8 ⁺ T-cell; chemotactic for T-cell; stimulates growth of intestinal epithelium
IL-16	Th, Tc	Chemoattractant for CD4 T, Mono and Eosino; induces MHC class II
IL-17	T	Proinflammatory; stimulates production of cytokines including TNF, IL-1 β , IL-6, IL-8, G-CSF
IL-17A	Th17, NK, Neutro	Proinflammstory; stimulates production of cytokines including TNF, IL-1 β , IL-6, IL-8, G-CSF by epithelial cells, endothelial cells, and fibroblasts.
IL-17F	Th17, NK, Neutro	Similar effects to IL-17A
IL-18	M ϕ , DC	Induces IFN γ production by T; enhances NK cytotoxicity
IL-19	Mono	Modulation of Th1 activity
IL-20	Mono, keratinocytes	Regulation of inflammatory responses to skin
IL-21	Th	Regulation of hematopoiesis; NK differentiation; B activation; T co-stimulation, Tfh polarization, and survival
IL-22	T	Inhibits IL-4 production by Th2

Table 8.1 (Continued)

Cytokine	Source	Effector function
IL-23	DC	Proliferation and IFN γ production by Th1; induces expansion and survival of Th17 cells. induction of proinflammatory cytokines such as IL-1, IL-6, TNF by macrophages
IL-24	Th2, Mono, M ϕ	Induction of TNF, IL-1, IL-6, antitumor activity
IL-25	Th1, M ϕ , Mast	Induction of IL-4, IL-5, IL-13, and Th2-associated pathologies
IL-26	T, NK	Enhanced production of IL-8 and IL-10 by epithelium
IL-27	DC, Mono	Induction of Th1 responses; enhanced IFN γ production
IL-28	Mono, DC	Type 1 IFN-like activity, inhibition of viral replication
IL-29	Mono, DC	Type 1 IFN-like activity, inhibition of viral replication
IL-30	APCs	P28 subunit of IL-27 heterodimer. Regulates IL-12 responsiveness of naive T-cells. Synergizes with IL-12 to induce IFN γ
IL-31	T	Promotes inflammatory responses in skin
IL-32	NK, T	Promotes inflammation. Role in activation-induced T-cell apoptosis
IL-33	Stroma, DC	Induction of Th2 cytokines; mediates chemotaxis of basophils and mast cells
IL-34	Stroma	Stimulates Mono proliferation and formation of macrophage progenitors
IL-35	Tregs	Immunosuppressive effects on Th1, Th2, and Th17 cells. Stimulates proliferation of Tregs
IL-36 α IL-36 β IL-36 γ	Keratinocytes, other barrier tissues, Neutro	Activates Mono, macrophages, keratinocytes to produce multiple proinflammatory cytokines. Co-stimulation of T-cells
IL-37	Unknown	Anti-inflammatory, possibly IL-18R antagonist. Not present in mouse
IL-38	Unknown	Anti-inflammatory, IL-36Ra homolog, possibly IL-36 receptor antagonist
Colony-stimulating factors		
GM-CSF	Th, M ϕ , Fibro, MC, Endo	Stimulates growth of progenitors of Mono, Neutro, Eosino, and Baso; activates M ϕ
G-CSF	Fibro, Endo	Stimulates growth of Neutro progenitors
M-CSF	Fibro, Endo, Epith	Stimulates growth of Mono progenitors
SLF	BM stroma	Stimulates stem cell division (<i>c-kit</i> ligand)
Tumor necrosis factors		
TNF (TNF α)	Th, Mono, M ϕ , DC, MC, NK, B	Tumor cytotoxicity; cachexia (weight loss); induces cytokine secretion; induces E-selectin on Endo; activates M ϕ ; antiviral
Lymphotoxin (TNF β)	Th1, Tc	Tumor cytotoxicity; enhances phagocytosis by Neutro and M ϕ ; involved in lymphoid organ development; antiviral
Interferons		
IFN α	Leukocytes	Inhibits viral replication; enhances MHC class II
IFN β	Fibroblasts	Inhibits viral replication; enhances MHC class II
IFN γ	Th1, Tc1, NK	Inhibits viral replication; enhances MHC class I and II; activates M ϕ ; induces switch to IgG2a; antagonizes several IL-4 actions; inhibits proliferation of Th2
Others		
TGF β	Th3, B, M ϕ , MC	Proinflammatory by, e.g., chemoattraction of Mono and M ϕ but also anti-inflammatory by, e.g., inhibiting lymphocyte proliferation; induces switch to IgA; promotes tissue repair

(Continued on p. 228)

Table 8.1 (Continued)

Cytokine	Source	Effector function
LIF	Thymic epith, BM stroma	Induces APP
Eta-1	T	Stimulates IL-12 production and inhibits IL-10 production by M ϕ
Oncostatin M	T, M ϕ	Induces APP

APP, acute phase proteins; B, B-cell; Baso, basophil; BM, bone marrow; Endo, endothelium; Eosino, eosinophil; Epith, epithelium; Fibro, fibroblast; GM-CSF, granulocyte–macrophage colony-stimulating factor; IL, interleukin; LIF, leukemia inhibitory factor; M ϕ , macrophage; MC, mast cell; Mono, monocyte; Neutro, neutrophil; NK, natural killer; SLF, steel locus factor; T, T-cell; TGF β , transforming growth factor- β .

Note that there is no interleukin-14. This designation was given to an activity that, upon further investigation, could not be unambiguously assigned to a single cytokine. IL-30 also awaits assignment. IL-8 is a member of the chemokine family. These cytokines are listed separately in Table 8.2.

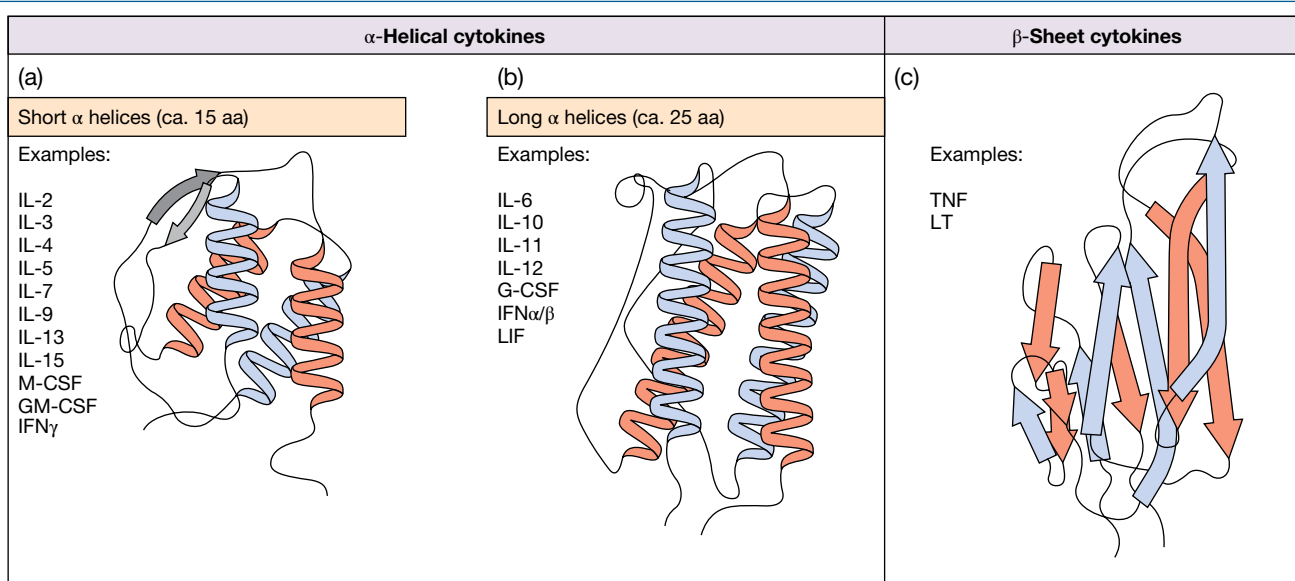


Figure 8.7 Cytokine structures. Cytokines can be divided into a number of different structural groups. Illustrated here are three of the main types of structure and some named examples of each type: (a) four short (~15 amino acids) α -helices, (b) four long (~25 amino acids) α -helices, and (c) a β -sheet structure. (Source: Michal G. (ed.) (1999) *Biochemical Pathways: An Atlas of Biochemistry and Molecular Biology*. John Wiley & Sons, New York. Reproduced with permission of Wiley.)

transient manner tightly coupled to the presence of foreign material (i.e., PAMPs) or tissue injury (DAMPs). For these reasons, the AU-rich sequences in the 3'-untranslated regions of the mRNA of many cytokines prime these mRNAs for rapid degradation, thereby ensuring that cytokine production rapidly declines in the absence of appropriate stimulation. Unlike endocrine hormones, *the majority of cytokines normally act locally in a paracrine or even autocrine fashion* (Figure 8.8).

Thus cytokines derived from lymphocytes rarely persist in the circulation, but nonlymphoid cells, such as endothelial cells and fibroblasts, can be triggered by bacterial products to release cytokines that may be detected in the bloodstream, often to the detriment of the host. Septic shock, for example,

is a life-threatening condition that largely results from massive overproduction of cytokines such as tumor necrosis factor (TNF) and IL-1 in response to bacterial infection and highlights the necessity to keep a tight rein on cytokine production. Certain cytokines, such as TNF, also exist as membrane-anchored forms and can exert their stimulatory effects without becoming soluble. As we shall see later, *cytokine production and downstream effector function are kept under tight control at multiple levels*, transcriptional, translational, as well as through use of decoy receptors (which bind cytokines but do not signal) and cytokine receptor antagonists (which compete with cytokines for binding to their cognate receptors).

Alternative functions of cytokines

Although cell–cell communication is the primary function of cytokines, emerging reports suggest that certain cytokines may also have direct effector functions as antimicrobial proteins. For example, IL-26, an IL-10-like cytokine that is primarily involved in the enhancement of IL-8 and IL-10 expression by epithelial cells, has also been reported to possess antibacterial properties through binding to bacterial membranes and disrupting these via an amphipathic region within the N-terminus of this cytokine. Furthermore, polymeric forms of IL-26 have also been reported to bind to DNA released from lysed bacteria, thereby enhancing uptake of the latter by macrophages. Although this aspect of cytokine function may be rare, it is worth bearing in mind that certain cytokines may have dual roles, just as complement factors

(such as C5) can have direct antibacterial effects as well as serving as chemotactic factors for neutrophils and activators of mast cells.

Cytokines act in hierarchical cascades

Before we get into the specifics of individual cytokines, it is important to bear in mind that these molecules act in hierarchical cascades (Figure 8.9), with *some cytokines exerting powerful systemic effects* (e.g., TNF, IL-1 family cytokines) that can lead to the production of numerous additional cytokines, chemokines, complement factors, antimicrobial peptides, and other proinflammatory proteins, while *other cytokines have more restricted effects* (e.g., IL-2, IL-4, IL-12) with their activities confined to specific cell types and their downstream effects on the production of additional cytokines and chemokines being much more limited (Figure 8.9). Thus, although all cytokines and chemokines are important in their own way, *some cytokines act as apical or upstream regulators* of many additional inflammatory factors, while *others act in a more distal or downstream role*.

Chemokines also play important roles in orchestrating immune responses

Although cytokines, especially those of the interleukin family, play the dominant role in shaping the nature of adaptive immune responses, chemokines (i.e., chemotactic cytokines) also play important roles in ensuring that cells of the innate as well as the adaptive immune system get to where they need to be. Chemokines (derived from the Greek *kinos*, movement) are small polypeptides (~8–10 kDa) *specialized in coordinating the movement of immune cells into tissues*. They play important roles in inflammation, lymphoid organ development, cell trafficking, cellular compartmentalization within lymphoid tissues, angiogenesis, and wound healing.

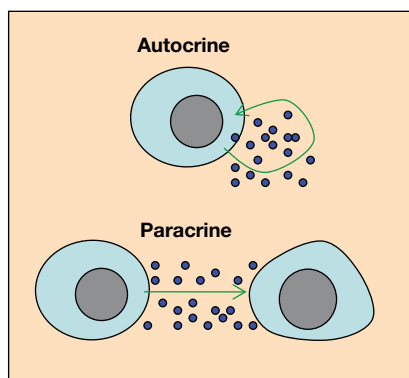


Figure 8.8 Cytokines act locally in an autocrine or paracrine manner. Cytokine actions are usually short range and can affect the cell producing the cytokine (autocrine effect) or cells in the locality (paracrine effect).

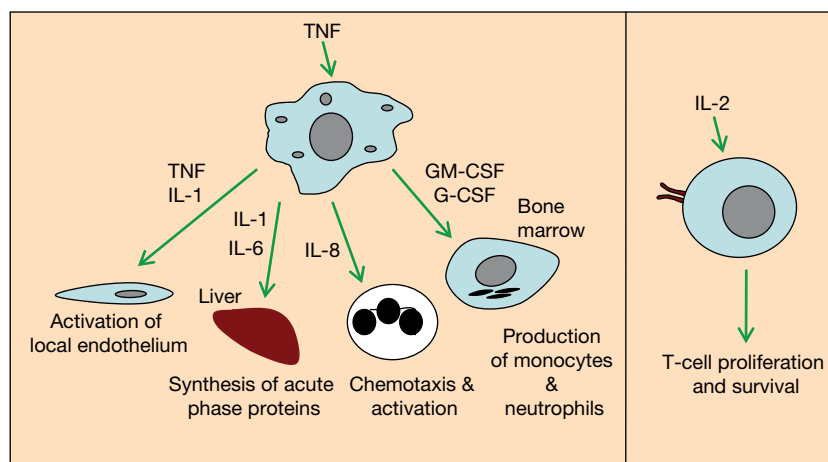


Figure 8.9 Some cytokines are broad acting whereas others can have more specific effects. Some cytokines exert global, broad-acting effects on multiple cell types (e.g., TNF, IL-1 family members), promoting the expression of multiple cytokines, chemokines, and proinflammatory factors, whereas other cytokines promote more specific localized effects on a relatively restricted cell type (e.g., IL-2).

Chemokines fall into two main functional classes: inflammatory and homeostatic

There are two broad functional classes of chemokines, **inflammatory chemokines** and **homeostatic chemokines**, with the former much more numerous and rapidly evolving than the latter. Inflammatory chemokines are typically inducibly expressed by cells of the innate immune system in response to infection and injury (i.e., PAMPs and DAMPs), with constitutive expression of these chemokines normally low. **Inflammatory chemokines act to guide cells of the innate and adaptive immune system, especially monocytes and neutrophils, to sites of active infection**, thereby helping to amplify immune responses that are already underway. For example, CXCL8 (which was unfortunately originally given the designation IL-8) is a chemokine par excellence for the recruitment of neutrophils to inflammatory sites, whereas MCP-1 (also called CCL2) is specialized at recruitment of macrophages. In humans, the inflammatory chemokines are localized predominantly in two large clusters on chromosome 4 (the CXC chemokines) and chromosome 17 (the CCL chemokines), reflecting their origin through recent gene duplication events (Figure 8.10). Inflammatory chemokines show a great deal of diversity and are undergoing rapid evolution, presumably due to the rapidly changing pathogen environment that humans have encountered over time. The latter chemokines can typically bind to multiple chemokine receptors, acting as agonists for some and as antagonists for others.

In contrast to the high degree of sequence diversity displayed by inflammatory chemokines, homeostatic chemokines are evolutionarily highly conserved, are constitutively produced, and are **involved in the deployment of cells of the immune system to the correct locations throughout the body** in noninfectious situations. Thus, homeostatic chemokines guide T-cells to lymph nodes, macrophages to the skin, B-cells to the lymph node follicles, and so on. Some chemokines exhibit properties of inflammatory and homeostatic chemokines and are therefore called dual-function chemokines. Homeostatic chemokines are localized singly or in miniclusters scattered throughout the genome (Figure 8.10). Because of their high degree of sequence conservation, homeostatic chemokines show a much greater degree of functional conservation between mice and humans and typically bind to a single receptor (although there are exceptions to this).

Chemokines comprise a diverse and large family

Chemokines can be produced by a variety of cell types and are divided into four families based on the disposition of the first (N-terminal) two of the four canonical cysteine residues (Table 8.2). CXC chemokines have one amino acid and CX3C have three amino acids between the two cysteines. CC chemokines have adjacent cysteines at this location, whereas C chemokines lack cysteines 1 and 3 found in other

chemokines. Chemokines bind to G-protein-coupled seven transmembrane receptors (Figure 8.11 and Figure 8.12). Despite the fact that a single chemokine can sometimes bind to more than one receptor, and a single receptor can bind several chemokines, many chemokines exhibit a strong tissue and receptor specificity.

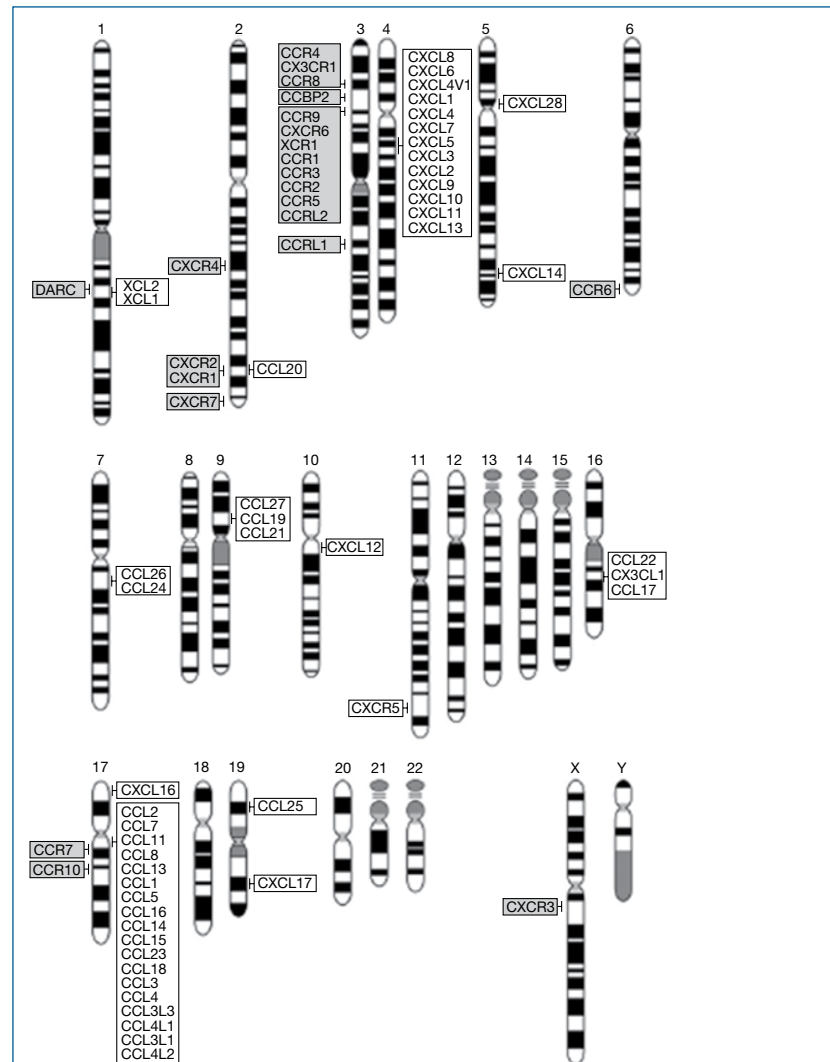


Figure 8.10 Chromosomal locations of human chemokines and their receptors. Chemokines (white boxes) and their receptors (gray boxes) are distributed over many chromosomes in humans. Inflammatory chemokines are found in two major clusters on chromosomes 5 (CXCL cluster) and 17 (CCL cluster), whereas the homeostatic chemokines are scattered throughout the genome singly or in pairs. Inflammatory chemokines are highly divergent and undergoing rapid evolution, presumably from pathogen-mediated selective pressure. Chemokine receptors are found predominantly on chromosomes 2 and 3. (Source: Zlotnik A. and Yoshie O. (2012) *Immunity* 36, 705–716. Reproduced with permission of Elsevier.)

Table 8.2 Chemokines and their receptors.

Family	Chemokine	Alternative names	Chemotaxis	Receptors
CXC	CXCL1	GRO α /MGSA α	Neutro	CXCR2 > CXCR1
	CXCL2	GRO β /MGSA β	Neutro	CXCR2
	CXCL3	GRO γ /MGSA γ	Neutro	CXCR2
	CXCL4	PF4	Eosino, Baso, T	CXCR3-B
	CXCL5	ENA-78	Neutro	CXCR2
	CXCL6	GCP-2/(CK α -3)	Neutro	CXCR1, CXCR2
	CXCL7	NAP-2	Neutro	CXCR2
	CXCL8	IL-8	Neutro	CXCR1, CXCR2
	CXCL9	Mig	T, NK	CXCR3-A, CXCR3-B
	CXCL10	IP-10	T, NK	CXCR3-A, CXCR3-B
	CXCL11	I-TAC	T, NK	CXCR3-A, CXCR3-B
	CXCL12	SDF-1 α/β	T, B, DC, Mono	CXCR4
	CXCL13	BLC/BCA-1	B	CXCR5
	CXCL14	BRAC/Bolekine	?	DC, Mono
	CXCL15	Lungkine	Neutro	?
	CXCL16	None	T, NKT	CXCR6
	CXCL17	DMC	DC, Mono	?
C	XCL1	Lymphotactin/SCM-1 α /ATAC	T	XCR1
	XCL2	SCM-1 β	T	XCR1
CX3C	CX3CL1	Fractalkine/Neurotactin	T, Nk, Mono	CX3CR1
CC	CCL1	I-309/(TCA-3/P500)	Mono	CCR8
	CCL2	MCP-1/MCAF	T, NK, DC, Mono, Baso	CCR2
	CCL3	MIP-1 α /LD78 α	T, NK, DC, Mono, Eosino	CCR1, CCR5
	CCL4	MIP-1 β	T, NK, DC, Mono	CCR5
	CCL5	RANTES	T, NK, DC, Mono, Eosino, Baso	CCR1, CCR3, CCR5
	(CCL6)	(C10/MRP-1)	Mono, M ϕ , T, Eosino	CCR1
	CCL7	MCP-3	T, NK, DC, Mono, Eosino, Baso	CCR1, CCR2, CCR3
	CCL8	MCP-2	T, NK, DC, Mono, Baso	CCR3
	(CCL9/10)	(MRP-2/CCF18/MIP-1 γ)	T, Mono	CCR1
	CCL11	Eotaxin-1	T, DC, Eosino, Baso	CCR3
	(CCL12)	(MCP-5)	T, NK, DC, Mono, Baso	CCR2
	CCL13	MCP-4	T, NK, DC, Mono, Eosino, Baso	CCR2, CCR3
	CCL14	HCC-1/HCC-3	T, Mono, Eosino	CCR1
	CCL15	HCC-2/Leukotactin-1/MIP-1 δ	T	CCR1, CCR3
	CCL16	HCC-4/LEC/(LCC-1)	T	CCR1
	CCL17	TARC	T, DC, Mono	CCR4
	CCL18	DCCK1/PARC/AMAC-1	T, DC	?
	CCL19	MIP-3 β /ELC/Exodus-3	T, B, DC	CCR7

(Continued on p. 232)

Table 8.2 (Continued)

Family	Chemokine	Alternative names	Chemotaxis	Receptors
	CCL20	MIP-3 α /LARC/Exodus-1	DC	CCR6
	CCL21	6Ckine/SLC/Exodus-2/(TCA-4)	T, DC	CCR7
	CCL22	MDC/STCP-1/ABCD-1	T, DC, Mono	CCR4
	CCL23	MPIF-1	T	CCR1
	CCL24	MPIF-2/Eotaxin-2	T, DC, Eosino, Baso	CCR3
	CCL25	TECK	T, DC, Mono	CCR9
	CCL26	SCYA26/Eotaxin-3	T	CCR3
	CCL27	CTACK/ALP/ESkine	T	CCR10
	CCL28	MEC	T, B, Eosino	CCR3/CCR10

The chemokines are grouped according to the arrangement of their cysteines (see text). The letter L designates ligand (i.e., the individual chemokine), whereas the letter R designates receptor. Names in parentheses refer to the murine homologs of the human chemokine where the names of these differ, or the murine chemokine alone if no human equivalent has been described.

B, B-cell; Baso, basophil; DC, dendritic cell; Eosino, eosinophil; MEC, mucosal epithelial chemokine; Mono, monocyte; Neuro, neutrophil; NK, natural killer; T, T-cell.

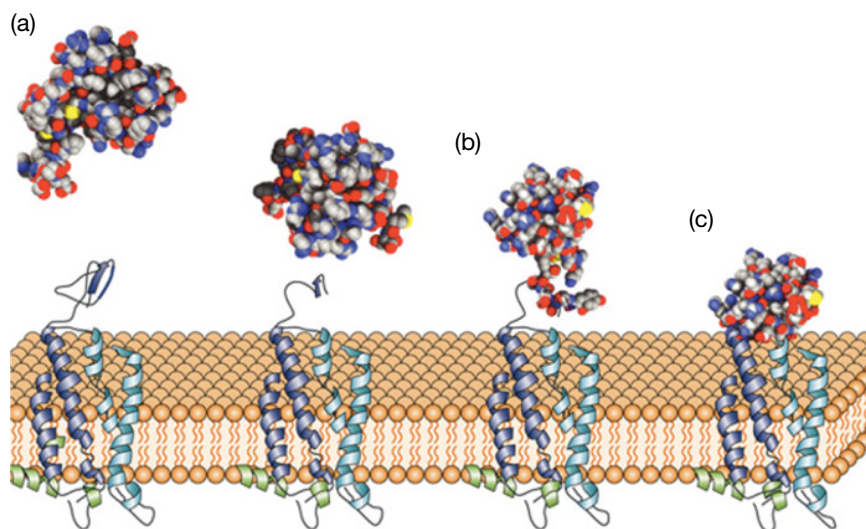


Figure 8.11 Model of RANTES docking with its receptor CCR5. The approach of the chemokine (a) is initially driven by electrostatic interactions between the negatively charged extracellular loops of the receptor and the positively charged surface of the chemokine. Following the initial docking (b), conformational changes occur in the amino terminus of the ligand, and other residues nearby, this results in (c) stabilization of the active conformation of the receptor. (Source: Schwarz M.K. and Wells T.N.C. (2002) *Nature Reviews Drug Discovery* 1, 347–358. Reproduced with permission of Nature Publishing Group.)

Inflammatory chemokines are relatively promiscuous and can bind to more than one receptor

Unlike cytokines, inflammatory chemokines typically bind to more than one chemokine receptor and each inflammatory chemokine receptor can bind more than one chemokine. To make matters even more complex, human and mouse inflammatory

chemokines are highly diverged, most likely because of distinct pathogen pressures on each organism, and the functionally equivalent chemokines in each organism are often difficult to ascertain. Thus, studies on mouse inflammatory chemokines are not readily translatable to the human context. Homeostatic chemokines are much more highly conserved between mouse and human and are far less promiscuous, typically binding to just a single receptor.

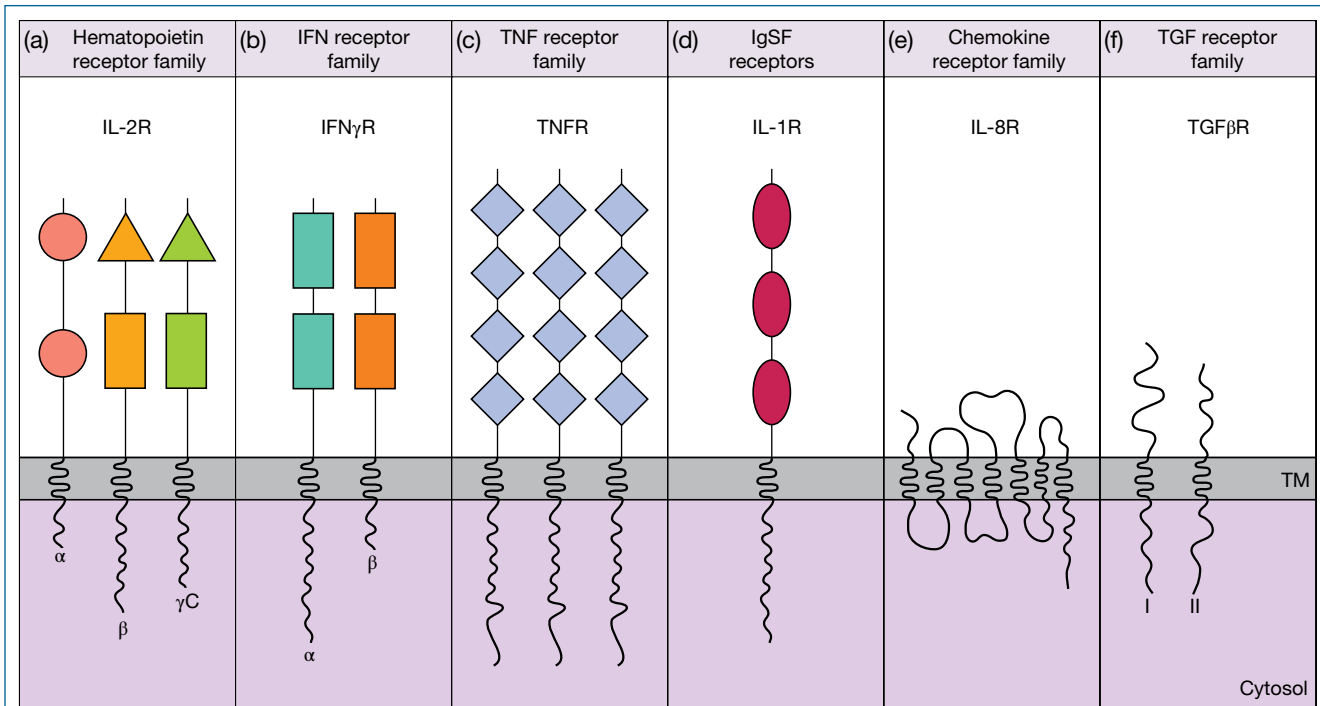


Figure 8.12 Cytokine receptor families. One example is shown for each family. (a) The hematopoietin receptors operate through a common subunit (γ^C , β c, or gp130, depending on the subfamily) that transduces the signal to the interior of the cell. In essence, binding of the cytokine to its receptor must initiate the signaling process by mediating hetero- or homodimer formation involving the common subunit. In some cases the cytokine is active when bound to the receptor either in soluble or membrane-bound form (e.g., IL-6). The IL-2 receptor is interesting with respect to its ligand binding. The α chain (CD25, reacting with the Tac monoclonal) of the receptor possesses two complement control protein structural domains and binds IL-2 with a low affinity; the β chain (CD122) has a membrane proximal fibronectin type III structural domain and a membrane distal cytokine receptor structural domain, and associates with the common γ chain (CD132) that has a similar structural organization. The β chain binds IL-2 with intermediate affinity. IL-2 binds to and dissociates from the α chain very rapidly but the same processes involving the β chain occur at two or three orders of magnitude more slowly. When the α , β , and γ chains form a single receptor, the α chain binds the IL-2 rapidly and facilitates its binding to a separate site on the β chain from which it can only dissociate slowly. As the final affinity (K_d) is based on the ratio of dissociation to association rate constants, then $K_d = 10^{-4} \text{ s}^{-1}/10^7 \text{ M}^{-1} \text{ s}^{-1} = 10^{-11} \text{ M}$, which is a very high affinity. The γ chain does not itself bind IL-2 but contributes towards signal transduction. (b) The interferon receptor family consists of heterodimeric molecules each of which bears two fibronectin type III domains. (c) The receptors for TNF and related molecules consist of a single polypeptide with four TNFR domains. The receptor trimerizes upon ligand binding and, in common with a number of other receptors, is also found in a soluble form that, when released from a cell following activation, can act as an antagonist. (d) Another group of receptors contains varying numbers of Ig superfamily domains, whereas (e) chemokine receptors are members of the G-protein-coupled receptor superfamily and have seven hydrophobic transmembrane domains. (f) The final family illustrated are the TGF receptors that require association between two molecules, referred to as TGFR type I and TGFR type II, for signaling to occur.

In humans, there are 23 chemokine receptors, largely localized to chromosome 3 (Figure 8.10), but five of these receptors are atypical (CXCR7, CCBP2, CCRL1, CCRL2, and DARC) and do not signal for chemotaxis, instead acting as antagonists of chemokine actions through acting as sinks for multiple chemokines.

Chemokines can act as agonists of one receptor and antagonists of another

Chemokines can also act to antagonize or suppress the actions of other chemokines. Indeed, because of their promiscuous receptor-binding behavior, many chemokines will act as agonists for some receptors while acting as antagonists for others. For example, chemokines that act as agonists for CXCR3 (CXCL9, CXCL10, CXCL11) are natural antagonists for CCR3, whereas

the CCR3 agonist CCL11 is a natural antagonist for CXCR3 (Figure 8.13). Furthermore, certain chemokine receptors (such as DARC and CXCR7) are atypical receptors that do not appear to signal but instead act to scavenge or recycle chemokines. DARC binds to multiple chemokines (e.g., CXCL1, CXCL2, CXCL3, CXCL7, CXCL8, and several CCL family chemokines) and may act as a sink for chemokines to downregulate their function.

Chemokines also have additional functions

In addition to their role as chemotactic factors, a number of chemokines have also been reported to have direct antimicrobial effects (i.e., the ability to directly lyse bacteria) and several also have roles as pro-angiogenic agents (especially CXCL8/IL-8), capable of triggering growth of new blood vessels to facilitate wound healing after infection. As we shall see in

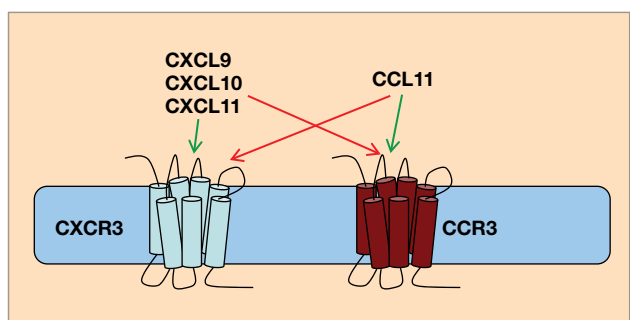


Figure 8.13 Chemokines can act as agonists of one receptor while acting as antagonists of another. Inflammatory chemokines are relatively promiscuous molecules that can bind to multiple chemokine receptors, as depicted. However, receptor binding can have agonistic as well as antagonistic effects.

Chapter 16, the pro-angiogenic (i.e., the ability to stimulate the growth of new blood vessels) properties of certain chemokines can also be exploited by solid cancers for their own ends. Finally, chemokines have also been implicated in the activation of neutrophils and macrophages, but mainly when received in combination with other stimuli.

Cytokines and chemokines act through distinct classes of cell surface receptors

Cytokines are highly potent, often acting at picomolar (10^{-12} M) concentrations, combining with small numbers of high-affinity cell surface receptors to produce changes in the pattern of RNA and protein synthesis in the cells they act upon. This is achieved through cytokine receptor-mediated activation of signal transduction cascades that culminate in the activation of transcription factors that direct the synthesis of batteries of new gene products, or increases the level of existing ones, within the cell (Figure 8.6). The end result is a *change in the behavior or functionality* of the cell as a result of these gene expression changes. *Cytokine receptors typically possess specific protein–protein interaction domains or phosphorylation motifs within their cytoplasmic tails to facilitate recruitment of appropriate adaptor proteins upon receptor stimulation.* These motifs serve as molecular velcro, enabling downstream signaling molecules to become associated with the receptor and become activated upon receptor engagement. A recurring theme in cytokine receptor activation pathways is the *ligand-induced dimer- or trimerization of receptor subunits*; this facilitates signal propagation into the cell through the interplay of the transiently associated receptor cytoplasmic tails. There are six major cytokine receptor structural families (Figure 8.12).

Hematopoietin receptors

This is the largest family of cytokines, sometimes referred to simply as the cytokine receptor superfamily, and members are named after the first member of this family to be defined – the hematopoietin receptor. These receptors generally consist of

one or two polypeptide chains responsible for cytokine binding and an additional shared (common or “c”) chain involved in signal transduction. The γ_c (CD132) chain is used by the IL-2 receptor (Figure 8.12a) and IL-4, IL-7, IL-9, IL-15, and IL-21 receptors; a β_c (CDw131) chain is shared by IL-3, IL-5, and granulocyte–macrophage colony-stimulating factor (GM-CSF) receptors; and gp130 (CD130) is shared by the IL-6, IL-11, IL-12, IL-27, oncostatin M, ciliary neurotrophic factor, and leukemia inhibitory factor (LIF) receptors.

Interferon receptors

These consist of two polypeptide chains and, in addition to the IFN α , IFN β , and IFN γ receptors (Figure 8.12b), this family includes the IL-10 receptor.

TNF receptors

Members of the TNF receptor superfamily possess cysteine-rich extracellular domains and exist as trimers that undergo a conformational change in their intracellular domains upon ligand binding. They include the tumor necrosis factor (TNF) receptor (Figure 8.12c) and the related Fas (CD95/APO-1) and TRAIL (DR4/DR5) receptors. This family also contains the lymphotoxin (LT) and nerve growth factor (NGF) receptors, as well as the CD40 receptor, which plays an important role in co-stimulation of B-cells and dendritic cells by activated T-cells.

IgSF cytokine receptors

Immunoglobulin superfamily members are broadly utilized in many aspects of cell biology and include the IL-1 receptor (Figure 8.12d), and the macrophage colony-stimulating factor (M-CSF) and stem cell factor (SCF/c-kit) receptors.

Chemokine receptors

Chemokine receptors comprise a family of approximately 20 different G-protein-coupled, seven transmembrane segment polypeptides (Figure 8.12e). As discussed earlier, each receptor subtype is capable of binding multiple chemokines within the same family (Figure 8.13). For example, CXC receptor 2 (CXCR2) is capable of binding seven different ligands within the CXC ligand (CXCL) family.

TGF receptors

Receptors for transforming growth factors such as the TGF β receptor (Figure 8.12f) possess cytoplasmic signaling domains with serine/threonine kinase activity.

Cytokine receptor signal transduction cascades

The ligand-induced homo- or heterodimerization of cytokine receptor subunits represents a common theme for signaling by cytokines. Numerous cytokines signal via the Janus kinase

(JAK)–STAT pathway, with several others activating the NF κ B pathway and the Ras–MAP kinase pathway. We have already discussed the details of the Ras–MAP kinase pathway in Chapter 7 (see Figure 7.10) so here we will focus on the JAK–STAT and the NF κ B activation pathways.

Signal transduction via the JAK–STAT pathway

Let us now look at the general strategy behind cytokine receptor-driven JAK–STAT activation. However, at the outset we should caution that the specific details will vary from cytokine receptor to cytokine receptor as there are four different JAKs and seven different STATs, which are engaged in distinct

combinations depending on the specific cytokine–cytokine receptor combination involved.

Members of the cytokine receptor superfamily (hematopoietin receptors) lack catalytic domains but are constitutively associated with one or more JAKs (Figure 8.14). There are four members of the mammalian JAK family: JAK1, JAK2, JAK3, and Tyk2 (tyrosine kinase 2) and all phosphorylate their downstream substrates at tyrosine residues. Genetic knockout studies have shown that the various JAKs have highly specific functions and produce lethal or severe phenotypes relating to defects in lymphoid development, failure of erythropoiesis, and hypersensitivity to pathogens.

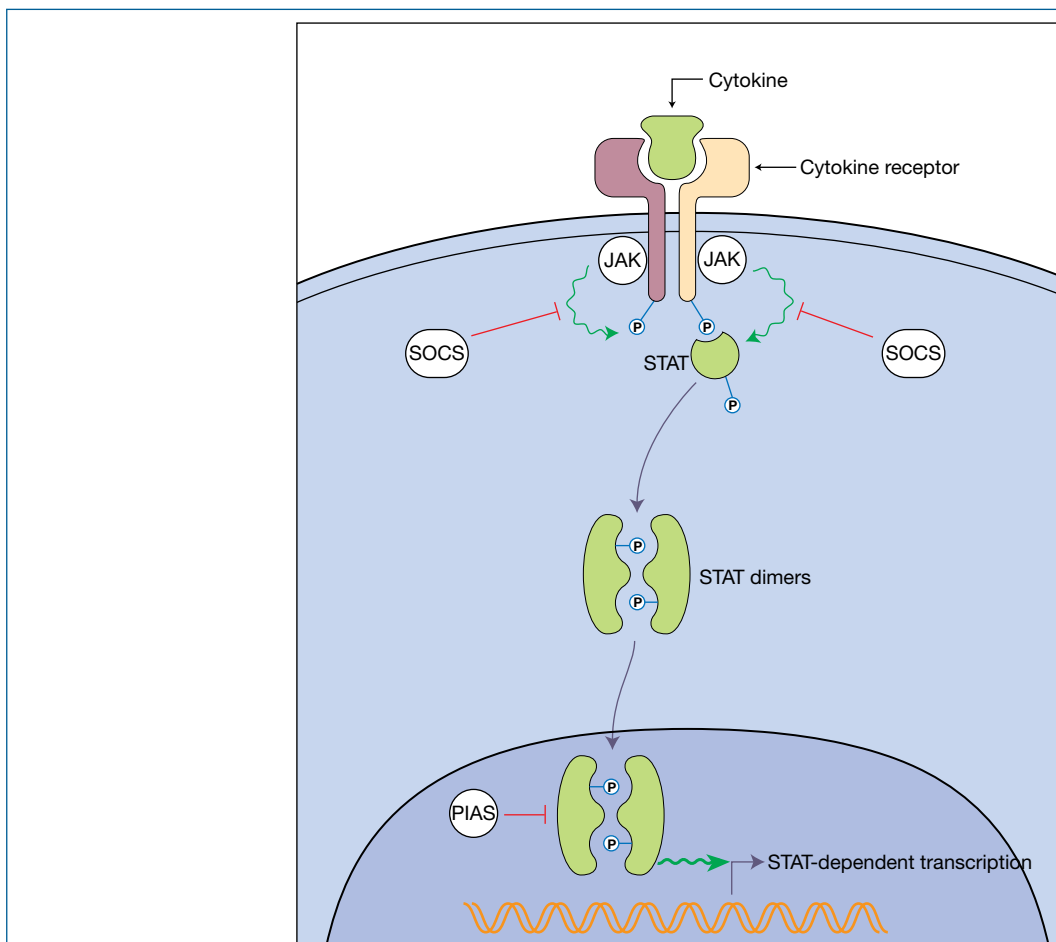


Figure 8.14 Cytokine receptor-mediated pathways for JAK–STAT-dependent gene transcription. Cytokine-induced receptor oligomerization activates JAK kinases that are constitutively associated with the receptor cytoplasmic tails. Upon activation, JAK kinases phosphorylate tyrosine residues within the receptor tails, thereby creating binding sites for STAT transcription factors that then become recruited to the receptor complex and are, in turn, phosphorylated by JAKs. Phosphorylation of STATs triggers their dissociation from the receptor and promotes the formation of STAT dimers that translocate to the nucleus to direct transcription of genes that have the appropriate binding motifs within their promoter regions. Members of the SOCS family of inhibitors can suppress cytokine signaling at several points, either through inhibition of JAK kinase activity directly or by promoting polyubiquitination and proteasome-mediated degradation of JAKs. The PIAS family of STAT inhibitors can form complexes with STAT proteins that either result in decreased STAT binding to DNA or recruitment of transcriptional corepressors that can block STAT-mediated transcription. Cytokine receptors can also recruit additional adaptor proteins such as Shc, Grb2, and Sos, that can activate the MAP kinase (see Figure 7.10) and PI3 kinase signaling cascades, but these have been omitted for clarity.

Upon cytokine-induced receptor dimerization or multimerization, JAKs are brought into close enough proximity to reciprocally phosphorylate each other, which leads to their activation. Active JAKs then phosphorylate specific tyrosine residues on the receptor cytoplasmic tails to create docking sites for members of the **STAT** (signal transducers and activators of transcription) family of SH2 domain-containing transcription factors. STATs reside in the cytoplasm in an inactive state but, upon recruitment to cytokine receptors (via their SH2 domains), become phosphorylated by JAKs and undergo dimerization and dissociation from the receptor. The dimerized STATs then translocate to the nucleus where they play an important role in pushing the cell through the mitotic cycle by activating transcription of various genes (Figure 8.14). Seven mammalian STATs have been described and each plays a relatively nonredundant role in distinct cytokine signaling pathways. Individual cytokines usually employ more than one type of STAT to exert their biological effects; this is because the hematopoietin receptors are composed of two different receptor chains that are capable of recruiting distinct STAT proteins. Further complexity is achieved as a result of the ability of STATs to form heterodimers with each other, with the result that a single cytokine may exert its transcriptional effects via a battery of STAT combinations. JAKs may also act through src family kinases to generate other transcription factors via the Ras–MAP kinase route (see Figure 7.10). Some cytokines also activate phosphatidylinositol 3-kinase (PI3K) and phospholipase C (PLC γ).

Downregulation of JAK–STAT signaling is achieved by proteins that belong to the SOCS (suppressor of cytokine signaling) and PIAS (protein inhibitor of activated STAT) families (Figure 8.14). SOCS proteins are induced in a STAT-dependent manner and therefore represent a classical feedback inhibition mechanism where cytokine signals induce expression of proteins that dampen down their own signaling cascades. The SOCS family contains eight members (namely CIS and SOCS1–SOCS7), and these proteins utilize two distinct mechanisms to downregulate cytokine signals. On the one hand, SOCS proteins can interact with JAKs, as well as other signaling proteins such as Vav, and target these proteins for degradation by the ubiquitin proteasome pathway (see Chapter 5). Alternatively, SOCS family proteins can interact with SH2-domain binding sites found within the activation loop of the JAK kinase domains, thereby blocking access of JAKs to their downstream substrates (Figure 8.14). Some SOCS family members, such as CIS (cytokine-inducible src homology domain 2 [SH2]-containing), can also directly interact with the STAT-binding SH2 domains found on cytokine receptors and by doing so can block recruitment of STAT molecules to the receptor complex. Targeted deletion of SOCS genes in the mouse has revealed the importance of these proteins for normal cytokine signaling. *SOCS1*-deficient mice display marked growth retardation and lymphocytopenia and die from inflammation-associated multi-organ failure within 3 weeks of birth.

Consistent with the role of SOCS proteins as negative regulators of cytokine signaling, lymphocytes derived from *SOCS1*-deficient mice undergo spontaneous activation even in pathogen-free conditions. *SOCS1*-deficient mice generated on a *RAG2*-deficient background do not display any of the phenotypes observed on a normal genetic background, confirming that SOCS1 exerts its effects primarily within the lymphocyte compartment.

The PIAS family consists of four members (PIAS1, PIAS3, PIASX, and PIASY) and can act to repress STAT-induced transcriptional activity by interacting with these proteins to either restrict their ability to interact with the DNA promoter elements they associate with, or alternatively, by recruiting transcriptional co-repressor proteins such as histone deacetylase to the STAT transcriptional complexes (Figure 8.14).

JAK–STAT pathways can also be regulated by other mechanisms such as protein tyrosine phosphatase-mediated antagonism of JAK activity, for example.

How is cytokine specificity achieved?

Given the multiplicity of cytokine receptors that utilize a relatively small pool of four JAKs and seven STATs, in addition to shared receptor signaling chains (e.g., β c, gp130), ***relatively minor differences in posttranslational modifications of the signaling participants (i.e., the JAKs and STATs themselves) is likely to lead to significant differences in the outputs of each receptor.*** These different modifications are initiated by cytokine-specific receptor chains that shape the signaling output of the common receptor chain. For example, although the GM-CSF, IL-3, and IL-5 receptors all share a common signaling β -chain, the ligand-specific α -chains will modify the β -chain signaling outputs.

Furthermore, ***different responses to even the same cytokine are seen in different cell types,*** at least in part due to epigenetic changes in chromatin that will make certain gene promoters inaccessible in particular cell types. For example, certain cell types (e.g., intestinal epithelium) respond to TNF by undergoing apoptosis, while others (e.g., macrophages) mount a strong proinflammatory gene expression program. Thus, the lineage of a cell activating a particular STAT combination may greatly influence the response seen. In other words, activation of the same STAT in a macrophage, versus a T-cell, for example, will undoubtedly result in different cohorts of gene expression events in either cell type owing to the epigenetic landscape (which affects accessibility of gene promoters) being radically different between these cell types.

Moreover, ***the context in which a cytokine signal is received will also greatly influence the response seen.*** Thus, the response observed towards cytokine B, preceded by cytokine A, is likely to be different from that seen towards cytokine B alone, because of upregulation of genes by cytokine A. Similarly, the response seen towards cytokine A and B simultaneously is likely to be very different to that seen towards A or B alone.

Let us now examine how GM-CSF, a cytokine which signals via the JAK–STAT pathway, promotes activation of its receptor and can result in divergent biological outcomes at low versus high ligand concentrations.

Activation of the GM-CSF receptor

The GM-CSF receptor is a heterodimer comprised of a ligand-binding α -chain that bears much of the responsibility for initial GM-CSF binding (GMR α) and a signaling β -chain (β c) subunit (Figure 8.15). The closely related IL-3 and IL-5 receptors share β c with the GM-CSF receptor but utilize ligand-specific α -chains. Similar to many other cytokine receptors, the GM-CSF receptor can signal a variety of cellular functions, including promoting cell division, suppression of apoptosis, commitment to myelopoiesis, and activation of mature monocytes and neutrophils. **Although the β c subunit is absolutely required for signaling in cells expressing GM-CSF, IL-3, and IL-5 receptors, the functional specificity of signaling is fine-tuned by the presence of the different α -chains.** Thus GM-CSF receptor engagement preferentially induces differentiation, whereas the IL-3R largely promotes proliferation. The cytoplasmic tail of the GM-CSF receptor is differentially phosphorylated at varying ligand concentrations and this is associated with distinct functional outcomes. The latter observation suggests that cytokine pleiotropy may be due to differences in posttranslational modifications of the receptor in response to different concentrations of GM-CSF.

The crystal structure of GM-CSF in complex with its receptor reveals a hexameric complex consisting of two GM-CSF molecules, two GMR α chains, and two β c chains, where

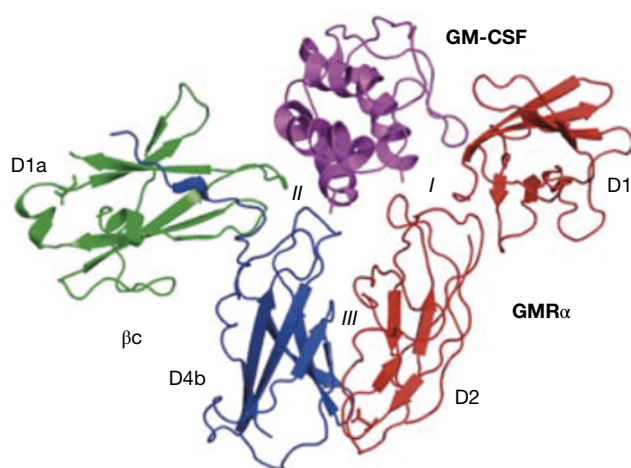


Figure 8.15 GM-CSF in complex with its receptor. The cytokine is shown in magenta, while the receptor subunits are colored according to the order in which they bind cytokine: red for the first subunit (GMR α chain) and blue and green for the second subunit (β c). Note that only part of the highly extended β c subunit is shown. (Source: Hercus T.R., *et al.* (2009) *Blood* **114**, 1289–1298. Reproduced with permission of the American Society of Hematology.)

the two β c chains are highly intertwined in an extended configuration (Figure 8.16). Similar to many other cytokine receptors, the GM-CSF receptor does not have intrinsic tyrosine kinase activity, but associates with the tyrosine kinase JAK2 that is required for β c transphosphorylation and the initiation of signaling. The cytoplasmic domains of both GMR α and β c are essential for receptor activation, but only β c associates with JAK2. The extended configuration of the intertwined β c chains keeps their cytoplasmic domains and associated JAK2 molecules more than 100 Å apart, a separation that likely prevents transphosphorylation and activation of the receptor. However, analysis of the crystal lattice of the GM-CSF receptor reveals a dodecamer complex consisting of two hexameric complexes which associate in a head-to-head orientation, bringing neighboring β c and GMR α chains into close proximity (Figure 8.17). The latter event permits dimerization and transphosphorylation of the receptor and initiation of signal transduction. Assembly of the dodecamer complex also facilitates the interaction of two GMR α chains that are essential for signal transduction. IL-3 receptor activation appears to proceed along similar lines.

Thus GM-CSF receptor activation occurs in a stepwise manner, with GM-CSF binding to GMR α chain forming a binary complex, which is then recruited to preformed β c dimers to generate a 2:2:2 arch-like hexameric complex (Figure 8.17). This is followed by the association of two hexameric complexes to form a dodecameric double-arch structure, leading to signal transduction (Figure 8.17). This mode of receptor activation raises the interesting possibility that the intermediate forms of receptor assembly (i.e., hexameric versus dodecameric) exhibit different biological activities. There is also some evidence that different residues in the receptor β c chains are phosphorylated at low versus high GM-CSF concentrations, resulting in distinct biological outcomes. This may explain reports that GM-CSF can selectively promote cell survival at very low (fM) cytokine concentrations in the absence of proliferation. In contrast, at high ligand concentrations (>10 pM) GM-CSF promotes both survival and proliferation. Different receptor conformations, or oligomeric states, at low versus high cytokine concentrations could explain the distinct biological outcomes.

Cytokine signal transduction via the NF κ B pathway

A number of important cytokines signal via the NF κ B activation pathway, including all of the members of the extended IL-1 family (IL-1 α , IL-1 β , IL-18, IL-33, IL-36 α , IL-36 β , IL-36 γ) and TNF α , as well as other members of the TNF superfamily (Fas, TRAIL, RANKL). **NF κ B is a transcription factor that is normally tethered in the cytoplasm through association with its inhibitor I κ B** (inhibitor of NF κ B). Degradation of I κ B, which occurs through phosphorylation of the latter by the IKK (I κ B kinase) complex, is central to NF κ B activation (Figure 8.18). **Phosphorylation of**

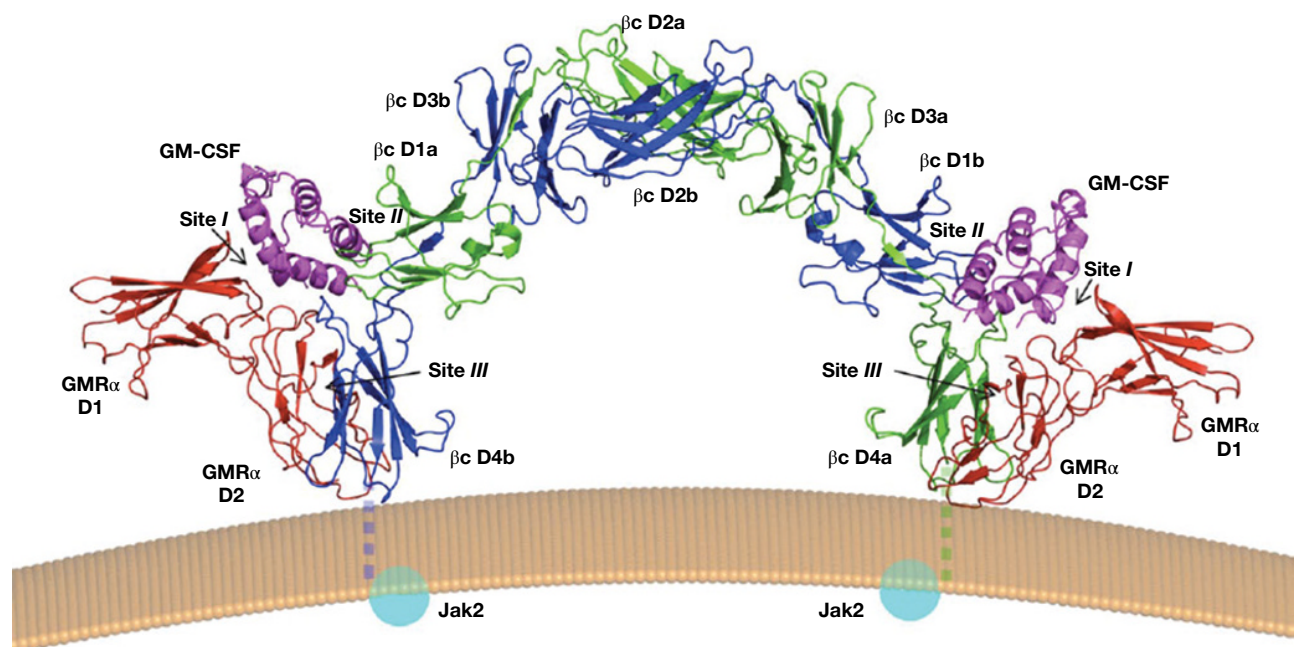


Figure 8.16 Crystal structure of the GM-CSF receptor ternary complex. Cartoon depicting the hexamer complex as it would sit on a cell surface. One monomer of βc is shown in green (chain a) and the other in dark blue (chain b). GM-CSF is shown in magenta, and GMR α in red. Labels denote the protein domains, whereas the location of the interacting surfaces (sites I–III) is indicated. The transmembrane regions, missing in the structure, are shown stylistically as dashed lines. JAK2 molecules, which are attached to the cytoplasmic tails of the receptor βc subunits, are shown as blue spheres. (Source: Hercus T.R., *et al.* (2009) *Blood* **114**, 1289–1298. Reproduced with permission of the American Society of Hematology.)

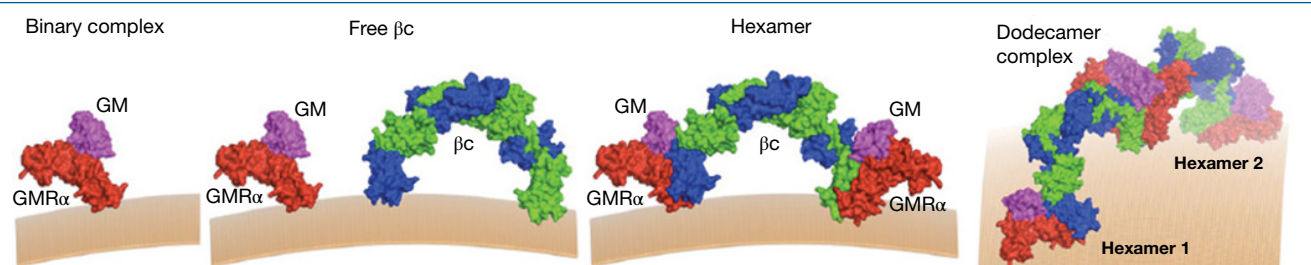


Figure 8.17 Model of GM-CSF receptor activation. The low-affinity binary complex consists of GM-CSF (magenta) bound to GMR (red). Interaction with free βc (blue and green) forms the high-affinity hexamer complex. Dodecamer (or higher order) complexes form by lateral aggregation of hexamer complexes to form a fully competent signaling complex. JAK2 associated with βc is able to dimerize and transphosphorylate in the dodecamer complex, but not in the hexamer complex. (Source: Hercus T.R., *et al.* (2009) *Blood* **114**, 1289–1298. Reproduced with permission of the American Society of Hematology.)

I κ B* by the IKK complex results in degradation of *I κ B via the ubiquitin proteasome pathway, which results in the unmasking of a nuclear localization signal on NF κ B that permits its entry into the nuclear compartment to bind its specific promoters (Figure 8.18). Another kinase, TAK1, is also involved in NF κ B activation in certain contexts. NF κ B activation can result in the expression of literally hundreds of genes, many of which are cytokines, chemokines, antimicrobial peptides, and proinflammatory factors that are centrally involved in the regulation of immune responses. NF κ B activation also results in the transcription of multiple genes (such as IAPs and FLIP, as well as

members of the Bcl-2 family) that can promote cell survival and enhance the viability of cells that activate this transcription factor.

The IKK complex is composed of three subunits – IKK α , IKK β , and the regulatory subunit IKK γ (also called NEMO) – and is activated through recruitment to polyubiquitin chains that are attached to upstream signaling molecules. These become associated with cell surface receptors (e.g., TNFR, IL-1R, IL-33R, IL-36R, FasR) that engage the NF κ B pathway owing to binding of their cognate cytokine. Association with polyubiquitin chains most likely changes the

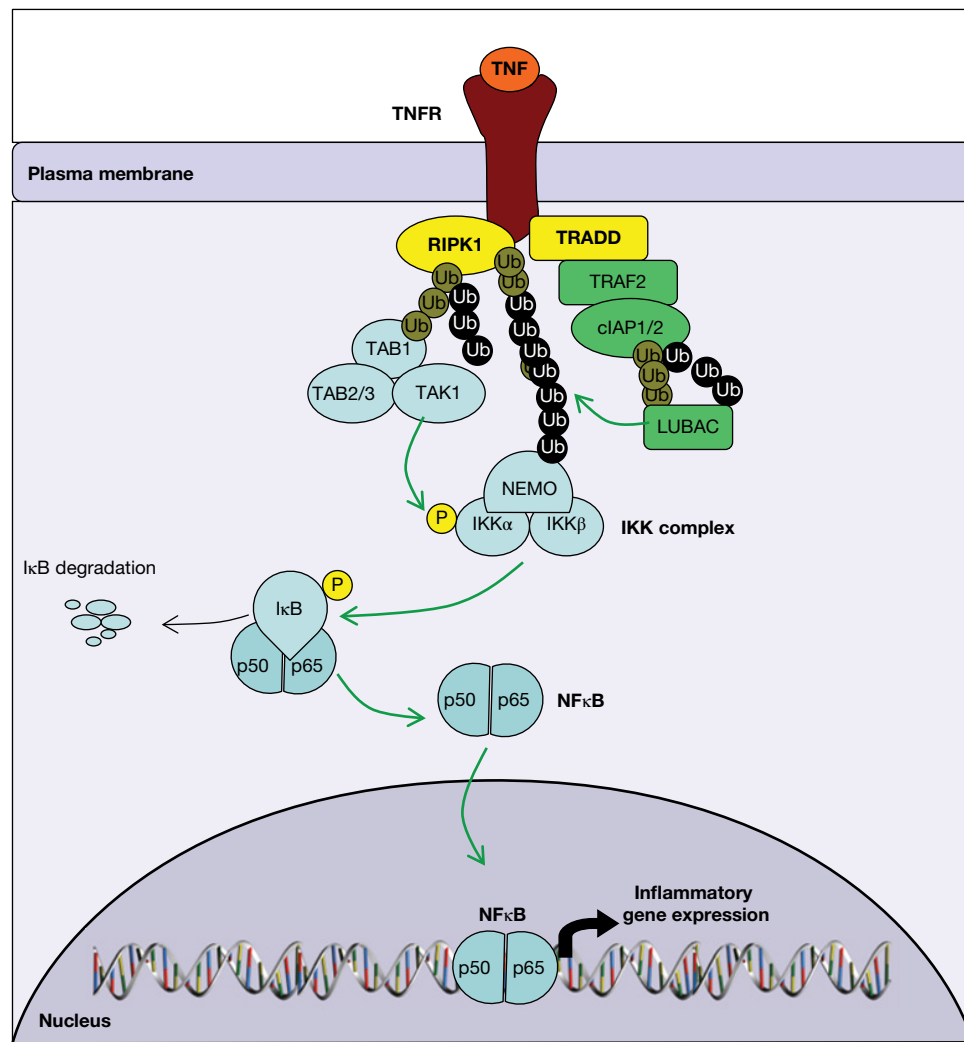


Figure 8.18 TNF receptor signal transduction. TNF-induced receptor trimerization triggers recruitment of TRADD, RIPK1, and TRAF2 to the receptor complex. TRAF2 and associated molecules, cIAP-1/c-IAP-2, promote ubiquitination of each other (green Ub symbols), as well as RIPK1, which facilitates recruitment of the linear chain ubiquitination complex (LUBAC). LUBAC adds linear ubiquitin chains (black Ub symbols) to RIPK1, which permits recruitment of the IKK complex (as well as the TAB/TAK complex in certain cell types). IKK phosphorylates the NFκB inhibitory molecule, IκB, which triggers its degradation via the proteasome, thereby liberating NFκB to translocate to the nucleus and activate numerous promoters.

conformation of the IKK complex regulatory subunit NEMO and permits it to activate the complex. To illustrate the sequence of events, we will use the TNF receptor as an example (Figure 8.18).

TNF: a cytokine that induces inflammation via the NFκB activation pathway

TNF is an important cytokine that is produced very early in response to tissue stress or encounter with PAMPs or DAMPs and is one of the most apical cytokines produced in response to infection. TNF promotes the production of numerous proinflammatory molecules and its overproduction can lead to autoimmune diseases such as rheumatoid arthritis, inflammatory

bowel disease, or psoriasis. As a consequence, neutralization of TNF using soluble receptor antagonists or neutralizing anti-TNF antibodies has led to dramatic improvements in the treatment of the latter conditions. TNF receptors are expressed on diverse cell types including monocytes, macrophages, DCs, T-cells, endothelial cells lining blood vessels, skin keratinocytes, and many other cells. TNF also activates local endothelium to permit neutrophil and monocyte extravasation and promotes the synthesis of numerous chemokines and cytokines from many nonimmune cell types.

In response to trimerization of the TNFR by TNF, an adaptor protein called TRADD is recruited to the cytoplasmic tails of the TNFR complex and this in turn recruits the RIPK1 kinase to the receptor (Figure 8.18). Several additional signaling

molecules are also recruited to this signaling complex, including the ubiquitin ligases TRAF2, cIAP-1 and -2 and the linear ubiquitination (LUBAC) complex (made up of the subunits HOIL and HOIP). The ubiquitin ligase activities of TRAF2/cIAP-1/cIAP-2 and the LUBAC complex modify RIPK1 (as well as each other) in a manner that permits the IKK complex to associate with RIPK1, leading to its activation. The activated IKK complex then phosphorylates I κ B, leading to NF κ B activation downstream (Figure 8.18).

TNFR signaling is negatively regulated by the deubiquitinases A20 and CYLD, which function by removing the ubiquitin chains from RIPK1, as well as other ubiquitinated molecules in the complex, thereby attenuating receptor activation. Members of the extended IL-1 cytokine family also signal via NF κ B, although the upstream kinases involved in the process are different, but the mechanisms are broadly similar.

Cytokines often have multiple effects

In general, cytokines are *pleiotropic* (i.e., exhibit multiple effects on a variety of cell types) (Table 8.1), and there is considerable overlap and redundancy between them with respect to individual functions, partially accounted for by the sharing of receptor components (as discussed in the preceding section) and the utilization of common transcription factors. For example, many of the biological activities of IL-4 overlap with those of IL-13 and a similar redundancy exists with respect to the biological activity of IL-1 α and IL-1 β , as well as the three members of the IL-36 family. However, it should be pointed out that virtually all cytokines have at least some unique properties. It is also highly relevant to note that cells will rarely if ever experience a single cytokine in isolation. Rather, *it is the additive and synergistic signals produced by particular cytokine combinations that conspire to produce the desired response*. In the case of T- and B-lymphocytes, signals received via cytokine receptors will also be combined with signals received via the TCR and BCR to produce different effector responses.

The cytokines produced at the initial stages of T- and B-cell activation critically influence the subsequent developmental fate of the cell on the receiving end. Their roles in the generation of T- and B-cell effectors, and in the regulation of chronic inflammatory reactions (Figure 8.3), will be discussed later in this chapter. We should also note here the important role of cytokines in the control of hematopoiesis (Figure 8.19). The differentiation of stem cells to become the formed elements of blood within the environment of the bone marrow is carefully nurtured through the production of cytokines by the stromal cells. These include GM-CSF, G-CSF (granulocyte colony-stimulating factor), M-CSF, IL-6 and -7, and LIF (Table 8.1), and many of them are also derived from T-cells and macrophages. It is not surprising, therefore, that during a period of chronic inflammation the cytokines that are produced recruit new precursors into the hematopoietic differentiation pathway – a useful exercise in the circumstances. One of the

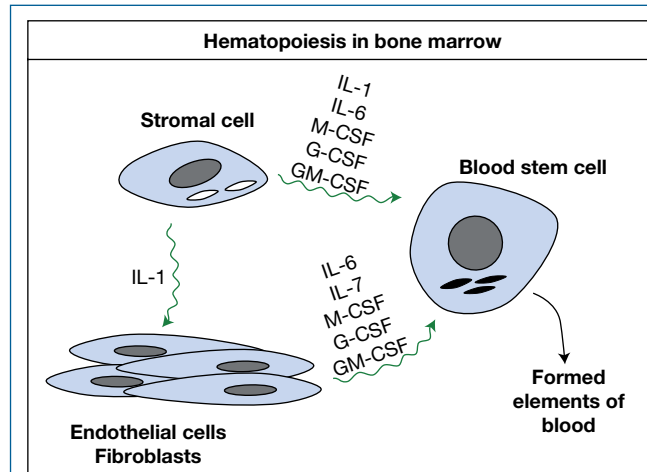


Figure 8.19 Multiple cytokines produced by effector T-cells and other cells of the immune system can influence hematopoiesis.

cytokines, IL-3, should be highlighted for its exceptional ability to support the early cells in this pathway, particularly in synergy with IL-6 and G-CSF (Figure 8.19).

Network interactions

The complex and integrated relationships between the different cytokines are mediated through cellular events. The genes for IL-3, -4, and -5 and GM-CSF are all tightly linked on chromosome 5 in a region containing genes for M-CSF and its receptor and several other growth factors and receptors. Interaction may occur through a cascade in which one cytokine induces the production of another, through transmodulation of the receptor for another cytokine and through synergism or antagonism of two cytokines acting on the same cell (Figure 8.20). Because of the number of combinations that are possible and the almost yearly discovery of new cytokines, the means by which target cells integrate and interpret the complex patterns of stimuli induced by these multiple soluble factors is only slowly unfolding.

Cytokine activities are fine-tuned through a variety of mechanisms

Because cytokines are powerful molecules, it is very important that their activities can be rapidly reined in, or that their effects can be felt only above certain concentration thresholds. Indeed, many autoimmune and autoinflammatory disorders, such as Crohn's disease, rheumatoid arthritis, and psoriasis are a consequence of deregulated cytokine production above normal levels. However, the good news is that many of these conditions are now treatable using monoclonal antibodies directed against specific cytokines or their cognate receptors (such as TNF or IL-17A) that neutralize the actions of such cytokines and damp down the inflammation they cause. So what are the strategies utilized by the immune system to fine-tune cytokine activities?

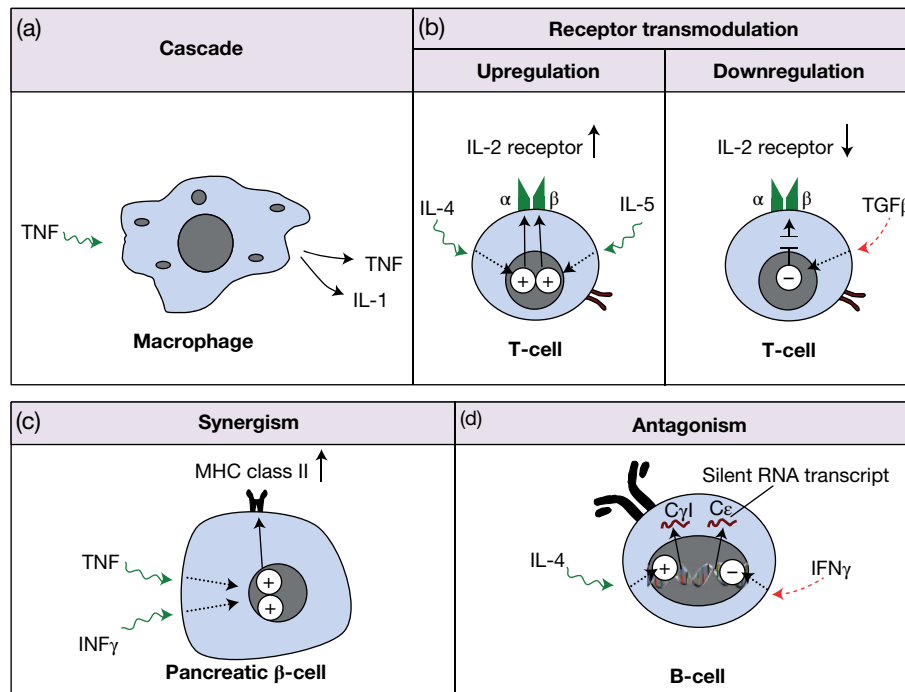


Figure 8.20 Network interactions of cytokines. (a) Cascade: in this example TNF induces secretion of IL-1 and of itself (autocrine) in the macrophage. (Note that all diagrams in this figure are simplified in that the effects on the nucleus are due to messengers resulting from the combination of cytokine with its surface receptor.) (b) Receptor transmodulation showing upregulation of each chain forming the high affinity IL-2 receptor in an activated T-cell by individual cytokines and downregulation by TGF β . (c) Synergy of TNF and IFN γ in upregulation of surface MHC class II molecules on cultured pancreatic insulin-secreting cells. (d) Antagonism of IL-4 and IFN γ on transcription of silent (“sterile”) mRNA relating to isotype switch (see Figure 8.24).

There are a number of mechanisms employed, including the use of *nonsignaling decoy receptors* that can bind cytokines but not respond. A good example of the latter is TNFR2 (TNF receptor 2), which can bind TNF but does not have a cytoplasmic signaling tail to allow it to propagate signals into the cell. Thus, TNFR2 effectively lowers the concentration of TNF available to TNFR1 (which does have a productive cytoplasmic signaling domain) by binding TNF but failing to propagate productive signals into the cell interior. Another means of antagonizing cytokine action involves the production of *cytokine receptor antagonists* (e.g., IL-1 receptor antagonist [IL-1Ra]), which are very closely related to cytokines, but do not activate the receptors they bind to. The latter molecules act as competitive inhibitors for cytokine receptor binding and set a threshold for cytokine activity, below which the natural cytokine cannot signal even if present. Several receptor antagonists have been identified within the extended IL-1 family, including IL-1Ra and IL-36Ra. Of note, individuals with deficiencies of the latter antagonists have been identified and these individuals typically present with a range of autoinflammatory conditions, including DIRA (deficiency in IL-1 receptor antagonist) and generalized pustular psoriasis, which can be life threatening. Yet another regulatory ploy involves the *production of soluble cytokine receptors*, such as soluble IL-2 receptor, soluble IL-4 receptor,

soluble IL-6 receptor, and others. These soluble receptors damp down cytokine activities through acting as a sink for excess cytokine.

In addition to decoy receptors and receptor antagonists, cytokine activities are also *fine-tuned through proteolysis* that can either enhance or disable their activities. A very well-known example of the former can be seen within members of the extended IL-1 family (which includes IL-1 α , IL-1 β , IL-18, IL-33, and IL-36) and many of these cytokines are initially produced as inactive pro-cytokines that require proteolytic processing for their activation. For example, IL-1 β and IL-18 are synthesized as completely inactive precursors and require processing by caspase-1 to achieve biological activity. Caspase-1 is activated in response to the detection of intracellular or extracellular pathogens that initiate the assembly of intracellular inflammasome complexes that promote the activation of caspase-1 (see Figure 1.20). In this way, the maturation of IL-1 β and IL-18 are closely coupled with the detection of pathogens, leading to their maturation via caspase-1-dependent proteolysis. Neutrophils, which are frequently the first responder cells of the immune system, are also a source of a number of proteases (such as elastase, cathepsin G, and proteinase-3) that are contained within their secondary granules and can be released into the extracellular space upon encounter with large pathogens, immune aggregates, or strong activation

stimuli (see Figure 1.9 and Figure 1.30). Emerging evidence also indicates that neutrophil-derived proteases can also process multiple members of the extended IL-1 family to enhance the activity of the latter cytokines, thereby serving as a means of escalating inflammation.

A final class of molecules that fine-tune the effects of cytokines are **intracellular antagonists of cytokine signaling pathways**, which interfere with the signal transduction pathways downstream from cytokine receptors. A good example of this is represented by the SOCS (suppressor of cytokine signaling) family proteins, which act downstream of many cytokines that activate the JAK–STAT pathway, discussed earlier in this chapter. Another example is A20, which deubiquitinates cytokine signaling molecules downstream of TNF signaling.

In summary, cytokine activities are regulated through the following mechanisms:

- Nonsignaling decoy receptors can bind cytokines but do not signal.
- Cytokine receptor antagonists can compete with cytokines for receptor binding.
- Soluble cytokine receptors can act as a “sink” for cytokines.
- Some cytokines (e.g., IL-1 family members) require proteolysis for activation.
- Intracellular molecules (e.g., SOCS, A20) can serve as antagonists of cytokine receptor signaling.

Activated T-cells proliferate in response to cytokines

As we learned in Chapter 7, having crossed the threshold required for activation, a T-cell enters the cell division cycle and undergoes clonal proliferation and differentiation to effectors. A succession of genes is upregulated upon T-cell activation. Within the first 30 minutes, nuclear transcription factors such as Fos/Jun and NFAT, which regulate IL-2 expression and the cellular proto-oncogene *c-myc*, are expressed, but the next few hours see the synthesis of a range of cytokines and their specific receptors. Much later we see molecules such as the transferrin receptor related to cell division and very late antigens such as the adhesion molecule VLA-1 that enables activated T-cells to bind to vascular endothelium at sites of infection. Collectively, these events equip activated T-cells with new functional properties, which include the ability to activate macrophages, provision of cytokine-mediated help for antibody production by B-cells, and the ability to eliminate virally infected targets by inducing apoptosis in such cells.

In so far as T-cells are concerned, clonal proliferation following activation is critically dependent upon IL-2 (Figure 8.21). This cytokine is a single peptide of molecular weight 15.5 kDa that acts only on cells that express high-affinity IL-2 receptors (Figure 8.12a). These receptors are not present on resting T-cells, but are synthesized within a few

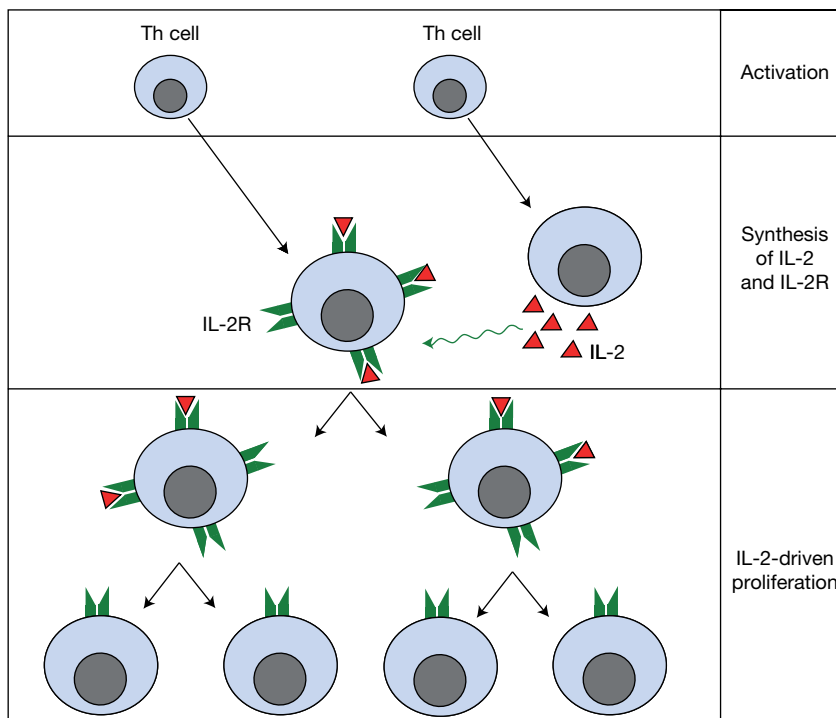


Figure 8.21 Activated T-blasts expressing surface receptors for IL-2 proliferate in response to IL-2. Produced by itself or by another T-cell subset. Expansion is controlled through downregulation of the IL-2 receptor by IL-2 itself. The expanded population secretes a wide variety of biologically active cytokines of which IL-4 also enhances T-cell proliferation.

hours after activation. Activated T-cells divide rapidly for 4–5 days, in an IL-2-dependent manner, and then differentiate into various effector subsets as we shall discuss below.

Separation of an activated T-cell population into those with high- and low-affinity IL-2 receptors showed clearly that an adequate number of high-affinity receptors were mandatory for the mitogenic action of IL-2. The numbers of these receptors on the cell increase under the action of antigen and of IL-2 and, as antigen is cleared, so the receptor numbers decline and, with that, the responsiveness to IL-2. It should be appreciated that although IL-2 is an immunologically nonspecific T-cell growth factor, it only functions appropriately in specific responses because unstimulated T-cells do not express high-affinity IL-2 receptors.

As we shall see, activated T-cells also produce an impressive array of other cytokines, and the proliferative effect of IL-2 is reinforced by the action of IL-4 and, to some extent, IL-6, which react with corresponding receptors on the dividing T-cells.

Different T-cell subsets can make different cytokine patterns

We have previously encountered the idea that different types of T-cells can be generated (Figure 8.1). Aside from the major subsets of CD4- and CD8-restricted T-cells, further *subfunctionalization of T-cells can be detected on the basis of the patterns*

of cytokines that these cells express. As we have noted earlier, the particular pattern of cytokines secreted by an activated T-cell is influenced by the nature of the cytokines it is exposed to upon initial encounter with antigen presented by a mature DC within the secondary lymphoid organs. **T-cell polarization** (i.e., further differentiation to a particular Th subset) can be further reinforced by cytokine signals that are encountered upon trafficking of the primed T-cell to the site of infection or site of further re-stimulation with antigen. In this way, T-cell responses can become tailored to the nature of the pathogen that instigated activation of the immune system in the first place. However, before we get further into the details of T-cell polarization, ***we would caution the reader not to think of this process as a rigidly constraining one***, but rather as a continuum of responses that can display particularly distinct patterns at specific points within the spectrum. Furthermore, T-cell polarization may not be an irreversible fate as there is evidence that polarized T-cells can adopt different polarized states unless repeatedly re-stimulated under particular polarization conditions.

Th cell polarization

Helper T-cell clones can be divided into four main subsets—Th1, Th2, Th17, and Tfh—with each displaying distinct cytokine secretion profiles (Figure 8.22), which in turn, influences the range of effector functions carried out by each subset. A further

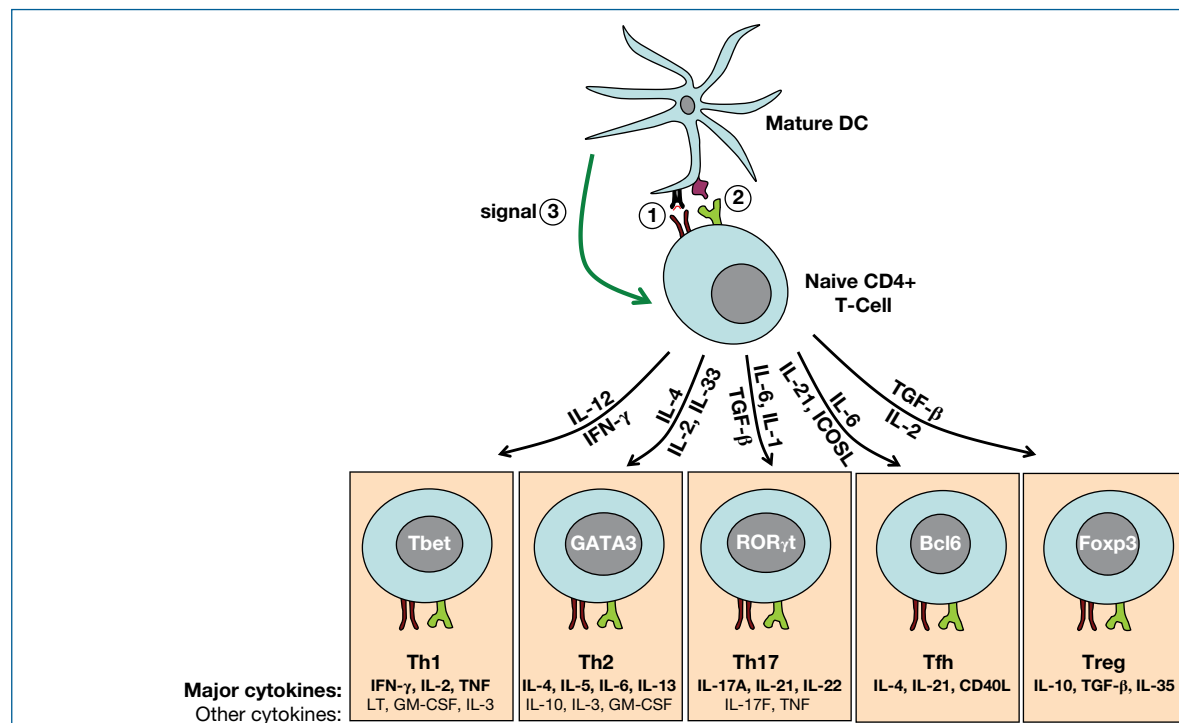


Figure 8.22 T-cells can undergo polarization to distinct subsets that secrete different cytokine combinations. Naive T-cells can undergo activation and polarization to distinct Th subsets. Cytokines produced by dendritic cells (DCs) or other innate immune cells, representing signal 3, dictate the differentiation fate of the T-cell, as shown. The master regulators of Th cell differentiation (Tbet, GATA3, ROR γ t, Bcl6, and Foxp3), which are switched on in the corresponding Th classes, are depicted.

subset of CD4⁺ T-cells has also been identified that exerts control over the other T-cell subsets by inhibiting their effector function; such cells are called regulatory T-cells or Tregs. Let us consider some of the properties that these cytokine profiles confer on their T-cell subsets.

Th1 cells coordinate responses to intracellular pathogens

Th1 cells secrete cytokine profiles skewed towards coordinating responses to **intracellular bacterial and viral infections** (Figure 8.22). This is achieved largely through activating macrophages and assisting the expansion of cytotoxic T-lymphocytes (Tc). Because they produce high amounts of IFN γ , Th1 cells are adept at activating macrophages, which is particularly important where macrophages have become infected with intracellular bacteria that actively antagonize macrophage function. When a Th1-polarized effector cell arrives at a site of infection, it can be re-stimulated by local macrophages that are either infected with intracellular bacteria or that have internalized bacterial fragments. Presentation of specific antigen via MHC class II molecules on the macrophage leads to directed secretion of IFN γ by the Th1 cell to activate the macrophage (Figure 8.23). However, in the absence of other signals, macrophages are not very responsive to IFN γ . This problem is also solved by the Th1 cell in the form of CD40L, which engages

CD40 on the macrophage and greatly increases its sensitivity to IFN γ . Th1 cells can also enhance the microbicidal functions of the macrophage to extracellular bacteria that are engulfed via phagocytosis (Figure 8.23). Recall from Chapter 1 that macrophages greatly increase their microbicidal properties upon activation, and IFN γ as well as TNF α is a very good way of achieving this. IFN γ -stimulated macrophages also produce IL-12 that leads to reinforcement of the Th1 phenotype.

Th1 cells also secrete high levels of IL-2 (Figure 8.22), which is able to support the expansion of CD8-positive cytotoxic T-cells, professional killers of virus-infected cells; we shall discuss how they kill later in this chapter. This can occur where activated T-cells have migrated to a site of infection and a Th1 cell engages an infected macrophage or DC (via MHC class II/peptide-TCR interactions) simultaneously with a CTL, which is engaged with the antigen-presenting cell (APC) via MHC class I/peptide-TCR interactions. This creates the circumstances where a CTL can be induced to clonally expand to swell its numbers because of IL-2 produced by the Th1 cell. We will see later in this chapter that a Th1 cell can also “license” a DC for stimulation of a Tc cell after the Th1 cell has already departed.

Other cytokines secreted by Th1 cells, such as IL-3 and GM-CSF, have more distant effects on bone marrow precursors and induce the production of neutrophils and macrophages to swell the ranks of these cells, as required, during an ongoing infection.

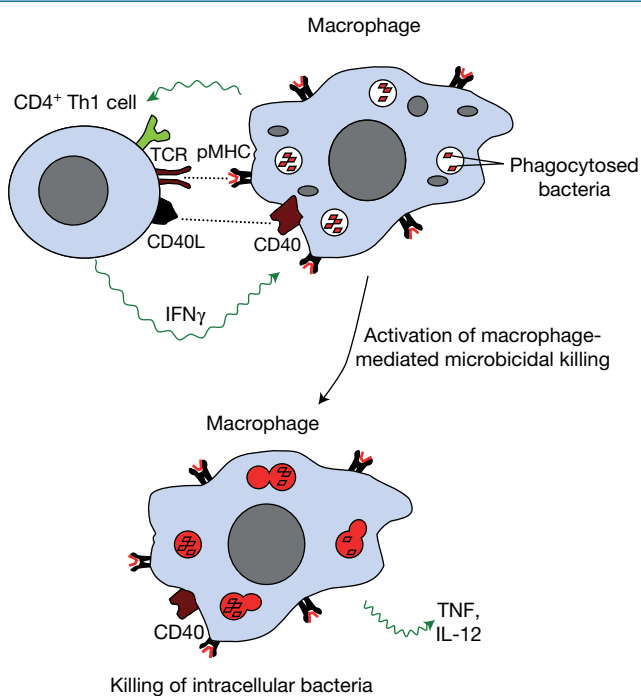


Figure 8.23 Th1 cells activate the microbicidal killing activity of macrophages. IFN γ derived from Th1 cells is important for the activation of macrophages and can enhance the microbicidal activity of such cells to kill phagocytosed bacteria. IFN γ can also induce the secretion of IL-12 and TNF by macrophages as shown.

Th2 cells coordinate responses to extracellular pathogens

Because of their ability to generate IL-4, IL-5, and IL-13 (Figure 8.22), all of which support B-cell proliferation, class switching and differentiation to effectors (Figure 8.24), Th2 cells are very good helpers for B-cells and would seem to be adapted for defense against parasites and other **extracellular pathogens** that are vulnerable to IL-4-switched IgE, IL-5-induced eosinophilia, and IL-3/4-stimulated mast cell proliferation. However, as we shall see, the generation of affinity-matured B-cells in germinal centers requires a different Th cell population, called T follicular helper (Tfh) cells, that collaborate with B-cells and follicular dendritic cells in the germinal center to select B-cells that have undergone somatic hypermutation to increase the affinity of their BCRs for antigen. Similar to Th1 cells, Th2 cells also produce IL-3 and GM-CSF to induce the production of neutrophils and macrophages from bone marrow precursors. IL-5 also acts at a distance and is particularly important for production of eosinophils (Figure 8.3), which, as we discussed in Chapter 1, are particularly well adapted towards combating large extracellular parasites such as parasitic worms. Owing to their physical size, these infectious agents cannot be readily phagocytosed by macrophages or neutrophils. To deal with this problem, eosinophils are equipped with specialized granules containing a range of cytotoxic molecules that are released onto the surface of the

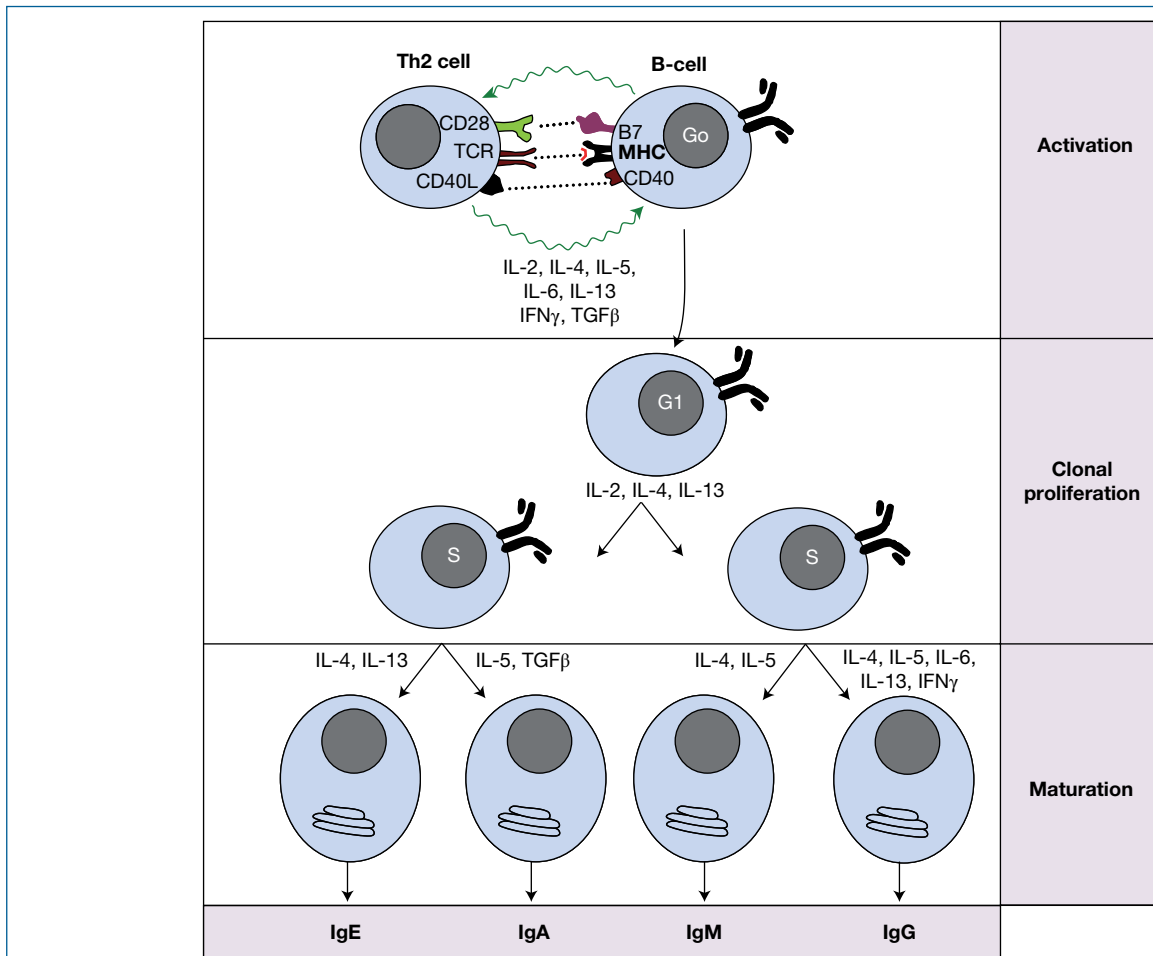


Figure 8.24 B-cell response to thymus-dependent (TD) antigen: clonal expansion and maturation of activated B-cells under the influence of T-cell-derived soluble factors. Co-stimulation through the CD40L–CD40 interaction is essential for primary and secondary immune responses to TD antigens and for the formation of germinal centers and memory. *c-myc* expression, which is maximal 2 hours after antigen or anti- μ stimulation, parallels sensitivity to growth factors; transfection with *c-myc* substitutes for anti- μ .

parasite upon engagement of the complement C3b receptors on the eosinophil with C3b-opsonized parasites.

Th17 cells promote acute inflammatory responses and recruit neutrophils

Th17 cells are IL-17A-producing cells that also secrete IL-17F, IL-21, and IL-22 (Figure 8.22). These cells appear to be specialized towards mounting massive inflammatory responses towards *extracellular bacterial and fungal infections*, particularly in the skin and at mucosal interfaces. This appears to be achieved through production of IL-17A, IL-17F, and IL-22, which have broad effects on many nonimmune cell types, such as endothelial and epithelial cells, and elicit the production of proinflammatory cytokines and chemokines by such cells to promote neutrophil recruitment to the site of inflammation. These cytokines also induce the secretion of antimicrobial peptides, by keratinocytes for example, which strengthens their barrier function towards infection. Th17 cells

also have a propensity to be involved in autoimmune reactions when the actions of these cells get out of control.

Tfh cells trigger the formation and maintenance of germinal centers

Although the existence of Th1, Th2, and Th17 cells has been known for some time, follicular helper T cells (Tfh) are a relatively recent addition to the Th cell ranks (Figure 8.22). *Tfh cells also give help to B-cells, but are specialized in the formation and maintenance of germinal centers within B cell follicles* of secondary lymphoid organs. Follicular helper T cells are mature CD4-positive T-cells that constitutively express the B-cell follicle homing receptor CXCR5 and are found within the B-cell regions of lymph nodes, spleen, and Peyer's patches, where they play a key role in the formation and maintenance of B-cell follicles through provision of CD40L, as well as secretion of IL-4 and IL-21. B-cell follicles are critically dependent on the continued presence of Tfh cells, as these cells provide a

multiplicity of signals (including CD40L, IL-4, IL-21, and a number of other signals that increase the dwell time between Tfh and B-cells) that are required for B-cell affinity maturation and differentiation to plasma cells. Tfh cells are also involved in weeding out (via FasL) B-cells that have unsuccessfully rearranged their BCR and no longer recognize antigen efficiently.

Cross-regulation of Th1, Th2, and Th17 subsets

Not only do the particular cytokines secreted by Th1, Th2, and Th17 cells enable them to elicit distinct biological functions, these cytokines also help to reinforce the same pattern of cytokine production, as well as inhibiting polarization to the alternative Th subset, a feature that is sometimes exploited to the benefit of certain pathogens. The ability of IFN γ , the characteristic Th1 cytokine, to inhibit the proliferation of Th2 clones, and of Th2-derived IL-4 and IL-10 to block both proliferation and cytokine release by Th1 cells, would seem to put the issue beyond reasonable doubt (Figure 8.25). Similarly, development of the Th1 or Th2 phenotype appears to be antagonistic to the development of Th17 cells.

Studies on the infection of mice with the pathogenic protozoan *Leishmania major* demonstrated that intravenous or intraperitoneal injection of killed promastigotes leads to protection against challenge with live parasites associated with

high expression of IFN γ mRNA and low levels of IL-4 mRNA; the reciprocal finding of low IFN γ and high IL-4 expression was made after subcutaneous immunization that failed to provide protection. Furthermore, nonvaccinated mice infected with live organisms could be saved by injection of IFN γ and anti-IL-4. These results are consistent with the preferential expansion of a population of protective IFN γ -secreting Th1 cells by intraperitoneal or intravenous immunization, and of nonprotective Th2 cells producing IL-4 in the subcutaneously injected animals.

Stability versus plasticity of Th subsets

The original Mosmann–Coffman classification into Th1 and Th2 subsets was predicated on data obtained with clones that had been maintained in culture for long periods and might have been artifacts of conditions *in vitro*. The use of cytokine-specific monoclonal antibodies for intracellular fluorescent staining, and of ELISPOT assays for the detection of the secreted molecules, has demonstrated that the Th1 and Th2 phenotypes are also apparent in freshly sampled cells and thus also applies *in vivo*. Nonetheless, it is perhaps best not to be too rigidly constrained in one's thinking by the Th1/Th2/Th17/Tfh paradigm, but rather to look upon activated T-cells as potentially producing a whole spectrum of cytokine profiles

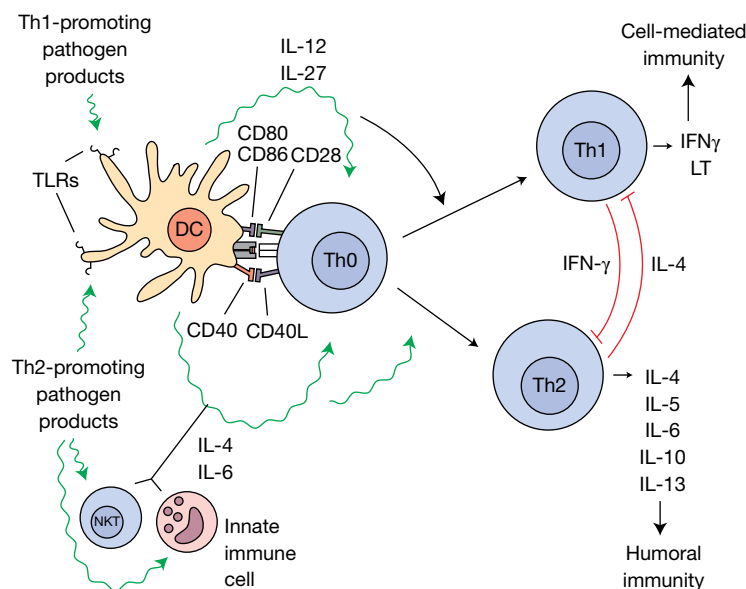


Figure 8.25 The generation of Th1 and Th2 CD4 subsets. Following initial stimulation of T-cells, a range of cells producing a spectrum of cytokine patterns emerges. Depending on the nature of the pathogen and the response of cells of the innate immune system during the initial stages of infection, the resulting T-helper cell population can be biased towards two extremes. Th1-promoting pathogen products (such as LPS) engage Toll-like receptors (TLRs) on dendritic cells (DCs) or macrophages and induce the secretion of Th1-polarizing cytokines such as IL-12 and IL-27. The latter cytokines promote the development of Th1 cells that produce the cytokines characteristic of cell-mediated immunity. IL-4, possibly produced by interaction of microorganisms with the lectin-like NK1.1⁺ receptor on NKT-cells or through interaction of Th2-promoting pathogen products with TLRs on DCs, skews the development to the production of Th2 cells whose cytokines assist the progression of B-cells to antibody secretion and the provision of humoral immunity. Cytokines produced by polarized Th1 and Th2 subpopulations are mutually inhibitory. LT, lymphotoxin (TNF β); Th0, early helper cell producing a spectrum of cytokines; other abbreviations as in Table 8.1.

(Th0, Figure 8.25), with possible skewing of the responses towards particular patterns depending on the nature of the antigen stimulus. Thus, other subsets may also exist, in particular the transforming growth factor β (TGF β) and IL-10-producing Th3/Tr1 (T-regulatory 1) cells, which are of interest because these cytokines can mediate immunosuppressive effects and may be involved in the induction of mucosally induced tolerance.

It is very likely that further T-cell subsets will be identified in the coming years and current evidence suggests that rather than each subset representing highly committed and distinct T-cell “lineages,” it seems that there is considerable plasticity in the spectrum of cytokines that differentiated T-cells can secrete. Furthermore, it is also apparent that *reprogramming of effector T-cells can occur*, converting differentiated T-cell subsets from one type to another.

Cells of the innate immune system shape the Th1/Th2/Th17/Tfh response

We have already introduced the concept that the cytokine milieu that becomes established by cells of the innate immune system during the early stages of infection has a major influence on the adaptive immune response (Figure 8.1 and Figure 8.2). In the initial stages of an infection, the innate immune responses hold the line as T-lymphocytes require priming by DCs to initiate clonal expansion and maturation to effectors. Upon migration of antigen-specific T-cells to lymph nodes where they come in contact with mature DCs fresh from their encounters with microbial pathogens, the pathogen products encountered by the DC will have polarized the latter in favor of secreting particular cytokines, as we have discussed above (Figure 8.1 and Figure 8.22). Polarization of T-cells towards a Th1, Th2, or other fate is achieved via signal 3 and the nature of this signal is strongly influenced by the conditions under which the DC is primed (Figure 8.4).

Th1 polarization

IL-12 and its relatives, IL-23 and IL-27, are instrumental in polarizing towards a Th1 cell phenotype (Figure 8.22). Invasion of phagocytic cells by intracellular pathogens induces copious secretion of IL-12, which in turn stimulates IFN γ production by NK cells. Engagement of many of the known Toll-like receptors (TLRs) on DCs by microbial products (such as LPS, dsRNA, and bacterial DNA) triggers DC maturation and induces IL-12 production, thereby favoring Th1 responses. Bacterial priming also induces CD40 receptor expression on DCs and induces responsiveness to CD40L, expressed by activated T-cells, for optimal IL-12 synthesis. IL-12 is also particularly effective at inducing IFN γ by activated T-cells and secretion of the latter by the T-cell further enhances IL-12 production and secretion by DCs; this acts as a classical positive feedback loop for enhancement of IL-12 production and further skews the response towards Th1. As we noted in Chapter 7, IL-12-induced activation of STAT4

is important for the induction of the Th1 master transcriptional regulator T-bet. This transcription factor activates T-cell expression of the key Th1 cytokines IFN γ and TNF α , while simultaneously upregulating cell surface expression of the IL-12R.

Th2 polarization

IL-4 is pivotal for the production of a Th2 cell phenotype. While IL-12 and IFN γ promote a Th1 response, these cytokines also inhibit Th2 responses (Figure 8.22). However, IL-4 effects appear to be dominant over IL-12 and therefore the amounts of IL-4 relative to the amounts of IL-12 and IFN γ will be of paramount importance in determining the differentiation of Th0 (i.e., unpolarized) cells into Th1 or Th2. IL-4 downregulates the expression of the IL-12R β_2 subunit necessary for responsiveness to IL-12, further polarizing the Th2 dominance. Stimulation of naive T-cells by IL-4 triggers the activation of STAT6, which turns on the *Th2 master transcription factor GATA3*, required to promote gene expression and secretion of the *Th2 cytokines IL-4, IL-5, and IL-13* from activated Th2 cells. It is still unclear whether signals from the innate immune system drive T-cells in the direction of a Th2 response or whether this is a default differentiation pathway for Th cells unless suppressed by Th1-polarizing signals such as IL-12 or IFN γ . A special cell population, the NKT cells bearing the NK1.1⁺ marker, rapidly releases an IL-4-dominated pattern of cytokines on stimulation. These cells have many unusual features. They may be CD4⁺CD8⁻ or CD4⁺CD8⁺ and express low levels of T-cell $\alpha\beta$ receptors with an invariant α chain and very restricted β , many of these receptors recognizing the nonclassical MHC-like CD1 molecule. Their morphology and granule content are intermediate between T-cells and NK cells. Although they express TCR $\alpha\beta$, there is an inclination to classify them on the fringe of the “innate” immune system with regard to their primitive characteristics and possession of the lectin-like NK1.1 receptor that may be involved in the recognition of microbial carbohydrates.

Th17 polarization

IL-6 and IL-1 in combination with TGF β are instrumental in the generation of Th17 cells, reinforced by IL-23, which appears to be important for expansion and stabilization of these cells (Figure 8.22). Naive T-cells do not express IL-23 receptors, but upregulate these upon productive activation, which is also enhanced by IL-6. Thus, the role of IL-23 in differentiation to Th17 cells is one of reinforcement rather than initiation. Although TGF β in combination with IL-6 and IL-1 influences the generation of Th17 cells, TGF β alone polarizes T-cells towards a Treg fate, as we shall discuss later. However, TGF β does not appear to play an instructive role for the production of Th17 cells, rather, it appears to act by suppressing the development of either the Th1 or Th2 phenotypes, which are antagonistic to the Th17 fate. IL-6 and TGF β promote STAT3-mediated activation of the transcription factor *Ror γ t*,

which is the master regulator of IL-17 differentiation. Ror γ t promotes expression of the *Th17* cytokines *IL-17*, *IL-22*, and *IL-23* in differentiated Th17 cells.

Tfh polarization

Although it is known that upregulation of the transcription factor Bcl6, which in turn upregulates the B-cell follicle homing chemokine receptor CXCR5, is critical for the development of Tfh cells, the events leading to expression of this lineage commitment factor are still being elucidated. CXCR5 expression on Tfh cells confers responsiveness to the chemokine CXCL13 and permits localization to follicles. Expression of Bcl-6 also represses the expression of transcription factors T-bet, GATA3, Ror γ t, and Foxp3 that are required for differentiation to Th1, Th2, Th17, and Treg cells, respectively. IL-6 and IL-21 appear to be important for development of Tfh cells, with IL-21 important for their continued survival (Figure 8.22). Upon expression of CXCR5, Tfh cells home to B-cell follicles where they receive co-stimulation (via inducible co-stimulator ligand [ICOSL]) by B-cells presenting antigen and this appears to further reinforce Tfh differentiation. Tfh cells are lost in ICOSL^{-/-} mice, or in mice treated with anti-ICOSL neutralizing antibodies. Furthermore, Tfh cells also require the continued presence of B-cells, suggesting that commitment to this Th fate is initiated by DCs but requires continuous reinforcement by B-cell-derived stimulation, most likely via ICOSL.

Further thoughts on Th polarization

Although there is a certain amount of evidence indicating the existence of subpopulations of dendritic cells specialized for the stimulation of either Th1, Th2, Th17, or Tfh populations, it seems that DCs are relatively plastic and can adopt a Th1-, Th2-, Th17-, or Tfh-polarizing phenotype depending on the priming signals they encounter from microbial and tissue-derived sources. However, it should be obvious from the discussion that the cytokines produced in the immediate vicinity of the T-cell will be important.

Policing the adaptive immune system

In addition to the effector T-cell subsets that we have already discussed, there is also much evidence that T-cells can also differentiate into cells that play a *suppressive or regulatory role* in immune responses (Figure 8.22). That is to say, these cells appear to police the actions of the other classes of T-cells, stepping in to quell immune responses when this appears necessary. Such cells are called regulatory T-cells, or Tregs, and there appear to be two different categories of such cells: *thymus-derived* and *peripherally derived Tregs*. These cells play a role in suppressing responses to self antigens, as well as inappropriate or undesirable responses to nonself antigens (such as commensal bacteria or food in the gut); indeed, it is now believed that Tregs control almost every adaptive immune

response. The strategy adopted by Tregs in stifling nascent autoimmune responses would appear to be to shadow other T-cells by clustering around DCs and other APCs. If the Tregs receive strong TCR signals from the same DC as a T-cell showing signs of activation (due to production of IL-2), the Treg can employ a range of strategies to suppress the development of full-blown effector function of nearby autoimmune T-cells (Figure 8.26). As we shall see later, Tregs can smother emerging autoreactive T-cell responses through secretion of IL-10, secretion of IL-35, depletion of IL-2, inhibition of co-stimulation by CTLA-4 and even through direct killing of the T-cell or the APC itself. Recent evidence suggests that Tregs also play an important role in promoting tissue-repair after injury through the production of tissue repair cytokines such as amphiregulin. We shall look at thymus-derived Tregs first as these appear to be the most abundant type.

Thymus-derived Tregs

Thymus-derived Tregs (also called natural Tregs) are a population of Foxp3⁺CD25⁺CD4⁺ T-cells that can suppress immune responses of autoreactive T-cells by mechanisms that are still not entirely understood, but appear to involve several distinct and possibly overlapping strategies. The current view is that these self-antigen-reactive T-cells develop in the thymus and are released as functionally mature cells that can act to dominantly suppress the activation of other self-reactive T-cells that escape negative selection in the thymus, possibly through competition for self-antigens presented by DCs or through CTLA-4-mediated signals from the Treg to the DC. Expression of the transcription factor Foxp3, which is upregulated in

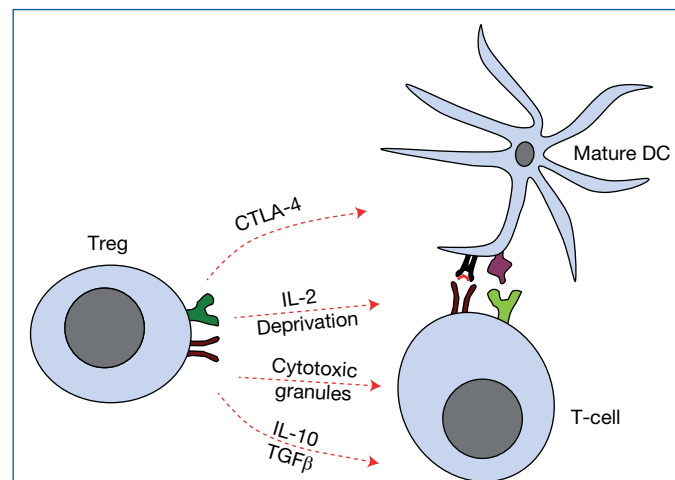


Figure 8.26 Diversity of mechanisms of Treg-mediated suppression. Regulatory T-cells (Tregs) may exert their regulatory functions on T-cells through the secretion of immunosuppressive cytokines, cytotoxic enzymes, or CTLA-4 cell-contact-dependent effects. These effects may act upon the T-cell undergoing regulation or on dendritic cells (DCs) or other antigen-presenting cells (APCs) presenting antigen to naive T-cells. See main text for further details.

response to TGF β and IL-2, induces the expression of cytokines, such as IL-10, that play a role in Treg function.

Thymus-derived Tregs (tTregs) constitute 5–10% of CD4-positive T-cells and their development is critically dependent on the induction of Foxp3, a transcription factor that can repress the transcription of Th1-, Th2-, and Th17-type cytokines. Loss-of-function mutations in the *Foxp3* gene result in a variety of inflammatory and autoimmune defects characterized by massive overproduction of Th1- and Th2-type cytokines, which is ultimately fatal. Tregs appear to be essential for the ongoing suppression of autoreactive T-cells, as their depletion results in the spontaneous development of autoimmune disease in otherwise normal mice. In humans, the equivalent condition resulting from mutations in the gene encoding Foxp3 is known as immune dysregulation, polyendocrinopathy, enteropathy, X-linked (IPEX). Autoimmune disease can also be provoked by adoptive transfer of Treg-depleted splenocytes from normal adult mice to syngenic recipients lacking T-cells. *In vitro* stimulation of Foxp3⁺ Treg-depleted cells from peripheral blood of healthy individuals has revealed that T-cells reactive towards multiple self-antigens are frequently present, but proliferation of these autoreactive T-cells can be readily suppressed by adding back Tregs. Such experiments argue that self-reactive T-cells that are not anergic probably exist in all individuals. Thus Tregs most likely exist to counter the actions of such cells and to prevent spontaneous autoimmunity from developing.

IL-2 is also crucial for the maintenance of thymus-derived Tregs as these T-cells are incapable of making their own IL-2, unlike activated T-cells, and rely fully on paracrine IL-2 for their survival. Consequently, the number of such cells is drastically reduced in *IL-2* and *IL-2R* knockout mice, with the result that these mice develop lymphoproliferation followed by lethal autoimmunity. The source of IL-2 for the maintenance of Tregs is unresolved but is now thought to come from autoreactive or antigen-activated T-cells that are interacting on the same DCs as the Treg. Thus, Tregs effectively steal IL-2 from nearby T-cells that have become activated on the same DC as a Treg and thus are likely to share the same antigen specificity (thus defining them as autoreactive). This simultaneously permits the Treg to expand as well as to deprive the potentially autoreactive T-cell of IL-2 which is critical for clonal expansion (Figure 8.21).

Peripherally derived Tregs

In contrast to thymus-derived Tregs, “peripherally derived” (also called inducible or adaptive) Tregs (pTregs) are generated from naive T-cells in the periphery after encounter with antigen presented by DCs. These regulatory T-cells are a diverse group, although it is not yet clear whether these peripherally derived Treg cell populations are truly distinct.

Th3 cells represent one subset of pTregs that have been found in mucosa and secrete IL-4, IL-10, and TGF β . Such cells seem to be important for oral tolerance and Th3 cells may

generally intervene to maintain tolerance towards the beneficial commensal microorganisms that populate our intestinal tract.

Tr1 cells have been described upon activation of T-cells in the presence of high concentrations of IL-10 *in vitro*. Tr1 cells secrete TGF β and may be induced by immature DCs presenting antigen in the absence of appropriate co-stimulatory ligands.

Foxp3⁺-inducible Tregs have been described where TCR activation occurs in the presence of TGF β and IL-2. Foxp3 pTreg cell differentiation also appears to be favored in particular tissue environments; gut-associated lymphoid tissues (GALT) being particularly amenable to the generation of such cells.

Tregs exert their effects through multiple mechanisms

As noted earlier, Tregs have been reported to exert their suppressive effects via a number of different strategies (Figure 8.26). Some Tregs appear to stifle T-cell responses through the **production of immunosuppressive cytokines** such as IL-10, TGF β , or IL-35. IL-10 suppresses T-cell responses by inhibiting the production of IL-2, IL-5, and TNF β and also through inhibiting the upregulation of MHC class II as well as B7 co-stimulatory ligands on DCs and macrophages. The latter effect has the consequence of antagonizing effective antigen presentation and co-stimulation of T-cells. TGF β also blocks cytokine production by T-cells, as well as cytotoxicity and proliferation. It is currently unclear how IL-35 suppresses T-cell function but it may act to suppress T-cell proliferation.

Treg-mediated **killing of APCs or effector T-cells** has also been reported. In this scenario, recognition of specific antigen by a Treg precipitates a cytotoxic T-cell killing reaction in which the Treg induces apoptosis in the APC presenting the Treg antigen, or in a nearby T-cell communicating with the same APC. Killing in this situation has been reported to be dependent on granzyme B and perforin expression by the Treg. Later in this chapter we will explore the detailed mechanism of granzyme B/perforin-mediated killing.

As noted earlier, competition for IL-2 with activated T-cells has also been implicated as an effector mechanism of Tregs, as such cells can utilize but do not make their own IL-2. The strategy here appears to be that the Treg competes for IL-2 made by nearby effector cells on the same DC, thereby reducing expansion of activated T-cells that are critically dependent on this cytokine for clonal proliferation.

Last, but by no means least, **CTLA-4**, the alternative receptor for B7 co-stimulatory ligands has been consistently reported to be important for Treg functions. Tregs bearing surface CTLA-4 could exert inhibitory effects on T-cell activation by a number of mechanisms. One way is through simple competition with T-cells for B7 ligands on APCs, another is by delivering negative signals to DCs via CTLA-4, which downregulates B7 ligands (i.e., CD80 and CD86) on the latter, rendering such cells incapable of productively activating naive T-cells. Indeed, Tregs have been observed to form aggregates around DCs and to suppress the upregulation of B7 ligands; such cells may also inhibit

cytokine production by DCs. Importantly, Treg-specific deletion of CTLA-4 results in the spontaneous development of systemic lymphoproliferation and fatal disease in mice.

It is likely that one or more of the above mechanisms operate concurrently, depending on the context. However **a core mechanism that may be common to all Tregs appears to operate via CTLA-4**, particularly with regard to natural Tregs, as such cells express high levels of this receptor. Let us take a look at the evidence. Blockade of CTLA-4 by monoclonal antibodies provokes organ-specific autoimmune disease and inflammatory bowel disease in otherwise healthy animals. Foxp3, along with other transcription factors, upregulates CTLA-4 via promoter-dependent effects. Mice lacking *CTLA-4*, specifically in thymus-derived Tregs, succumb to a variety of autoimmune diseases in a manner similar to *Foxp3*-deficient mice.

Irrespective of the precise mechanism of action, all are agreed that Tregs are extremely important for policing the activities of potentially autoreactive T-cells, as well as for limiting excessive responses to nonself antigens. As a consequence, failure to mount effective Treg responses frequently results in autoimmune disease.

A TCR-independent role for Tregs in promoting tissue repair

In addition to their TCR-dependent role in suppressing responses of activated T-cells through one or more of the mechanisms described above, recent evidence suggests that

Tregs can also exert TCR-independent effects and can mount a tissue-protective response through secretion of wound-healing proliferation-inducing cytokines such as amphiregulin, a member of the EGF family. This tissue-protective role is induced through release of DAMPs, such as IL-18 and IL-33, from dead cells that promotes expansion of local Tregs and increased expression of amphiregulin, which appears to be critical for promoting repair of damaged tissue (Figure 8.27). Consequently, conditional knockout of amphiregulin in $CD4^+Foxp3^+$ Tregs led to marked increases in acute lung damage in response to influenza infection. Importantly, amphiregulin production by Tregs does not appear to require TCR stimulation but appears to be induced directly via IL-18 and IL-33-mediated effects on Tregs. Thus, Tregs can play anti-inflammatory tissue protective roles in two distinct ways: by suppressing effector T-cell responses that can increase recruitment of damaging neutrophil and macrophage responses, and through production of tissue-repair cytokines such as amphiregulin that can directly promote wound healing.

A subset of DCs may also have cytotoxic effects on T-cells to downregulate immune responses

Although DCs are known primarily for their ability to present antigen for the purpose of eliciting T-cell activation, recent evidence also suggests that a subset of DCs express perforin, a pore-forming molecule that is most often found within cytotoxic T-cells and NK cells. It appears that perforin-expressing DCs present self-antigens to T-cells, apparently as a strategy to lure

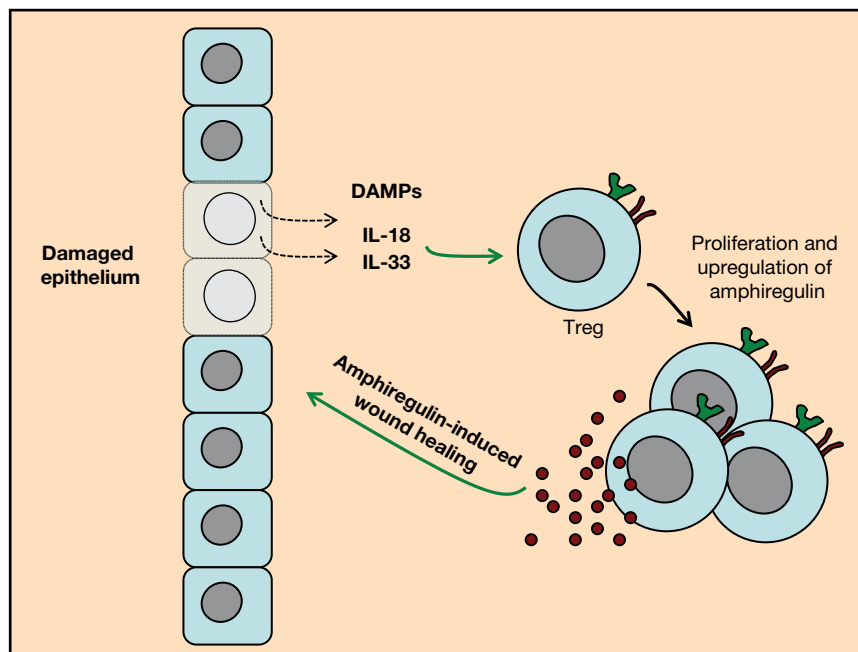


Figure 8.27 Tregs play a TCR-independent role in wound healing. Regulatory T-cells (Tregs) can respond to DAMPs released in response to tissue injury through proliferation (in a TCR-independent manner) followed by secretion of the EGF-like cytokine amphiregulin which can promote proliferation of local epithelium to facilitate wound healing.

these cells out of the woodwork, followed by killing of responding T-cells rather than provision of co-stimulation. Depletion of these perforin-expressing DCs permits the survival of autoreactive T-cells in certain models of autoimmunity. Goodness, is there just no place for an autoreactive T-cell to hide?

CD8⁺ T-cell effectors in cell-mediated immunity

CD8⁺, MHC class I-restricted, cytotoxic T-cells (Tc), also referred to as cytotoxic T-lymphocytes (CTLs), represent the other major arm of the cell-mediated immune response and are of strategic importance in the killing of virally infected cells and also contribute to the surveillance mechanisms against cancer cells. Emerging evidence also suggests that CTL and NK cells may also exert cytotoxic effects against intra- and extracellular bacteria. Although some CD4⁺ T-cells are also capable of cytotoxic killing, the majority of CTL-killing is derived from the CD8⁺ T-cell population.

The generation of cytotoxic T-cells

CTL precursors recognize antigen on the surface of cells in association with class I MHC molecules and, like B-cells, they usually require help from T-cells. The mechanism by which help is proffered may, however, be quite different to how Th2 cells stimulate B-cell proliferation and differentiation to effectors. As explained earlier, effective T-cell–B-cell collaboration is usually “cognate” in that the collaborating cells recognize two epitopes that are physically linked (usually on the same molecule). If we may remind the reader without causing offense, the reason for this is that the surface Ig receptors on the B-cell capture native antigen, process it internally, and present it to the Th as a peptide in association with MHC class II. Although it has been shown that linked epitopes on the antigen are also necessary for cooperation between Th and the cytotoxic T-cell precursor (Tcp), the nature of T-cell recognition prevents native antigen being focused onto the Tcp by its receptor for subsequent processing, even if that cell were to express MHC II, which in its resting state it does not. It seems most likely that Th and Tcp bind to the same APC, for example a dendritic cell, which has processed viral antigen and displays processed viral peptides in association with both class II (for the Th cell) and class I (for the Tcp) on its surface; one cannot exclude the possibility that the APC could be the virally infected cell itself. Cytokines from the triggered Th will be released in close proximity to the Tcp, which is engaging the antigen–MHC signal and will be stimulated to proliferate and differentiate into a Tc under the influence of IL-2 and IL-6 (Figure 8.28a). However, interaction of the APC with the Th and the Tc cell can be temporally separated and, in this case, it appears that the helper T-cell “licenses” the dendritic cell for future interaction with the cytotoxic T-cell. It does this by activating the DC through CD40, thereby upregulating co-stimulatory molecules and cytokine production, in particular IL-12, by the DC (Figure 8.28b). An entirely

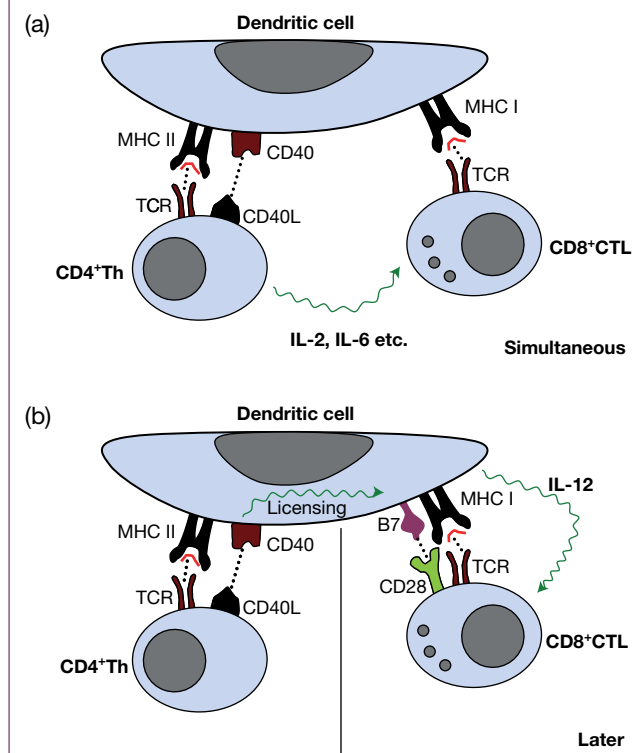


Figure 8.28 T-helper cell activation of cytotoxic T-cells. Activation of the CD4⁺ helper T-cells (Th) by the dendritic cell involves a CD40–CD40 ligand (CD154) co-stimulatory signal and recognition of an MHC class II peptide presented by the T-cell receptor. (a) If both the Th and the cytotoxic T-lymphocyte (Tc) are present at the same time, the release of cytokines from the activated Th cells stimulates the differentiation of the CD8⁺ precursor into an activated, MHC class I-restricted Tc. However, as shown in (b), the Th and the Tc do not need to interact with the APC at the same time. In this case, the Th cell “licenses” the dendritic cell for future interaction with a Tc cell. Thus the Th cell, by engaging CD40, drives the dendritic cell from a resting state into an activated state with upregulation of co-stimulatory molecules such as B7.1 and B7.2 (CD80 and CD86, respectively) and increased cytokine production, particularly of IL-12.

Th-independent mechanism of Tc activation is also thought to occur. This has been demonstrated in, for example, the response to protein antigens given with potent adjuvants such as immunostimulatory DNA sequences (ISSs), in this case possibly involving adjuvant-induced production of proinflammatory cytokines and cell surface co-stimulatory molecules.

The lethal process

As noted above, cytotoxic T-cells are generally of the CD8 subset, and their binding to the target cell through TCR-mediated recognition of peptide presented on class I MHC is assisted by interactions between CD8, the co-receptor for class I, and by other accessory molecules such as LFA-1 and CD2 that increase the affinity of the interaction between the CTL and the target cell (see Figure 7.3).

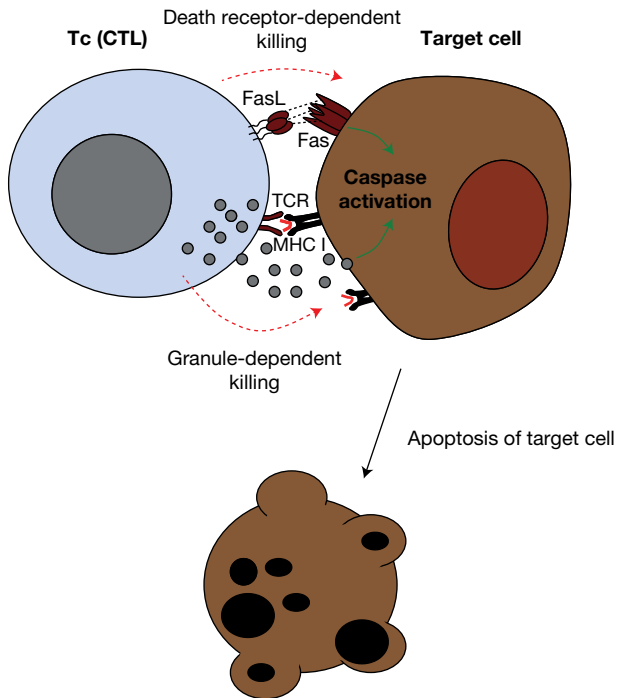


Figure 8.29 Cytotoxic T-cells (Tc, or CTL) can kill target cells via the granule-dependent or Fas ligand (FasL)-dependent, pathways to apoptosis. Both pathways result in the activation of members of the caspase family of proteases within the target cell and these enzymes kill the target through proteolysis of hundreds of substrate proteins. See Figure 8.31 and Figure 8.32 for further details on the mechanism of cell killing by either pathway.

Upon recognition of a suitable target cell, CTLs are capable of killing via two distinct pathways; the *Fas/Fas ligand pathway* and the *perforin/granzyme pathway*, which are not mutually exclusive as both killing options may be available to an individual CTL (Figure 8.29). Both killing pathways culminate in the activation of a family of cytotoxic proteases called caspases within the target cell that coordinate the cell-killing process from within; the only difference between the two pathways is how the caspases become activated. Comparison between T-cells lacking functional Fas ligand as well as perforin and T-cells lacking perforin alone has demonstrated that these two pathways account for most of the killing activity of CTLs (as well as NK cells), with TNF accounting for a minor component of CTL killing. We will deal with the perforin/granzyme and Fas-dependent killing mechanisms in turn.

Perforin/granzyme-dependent killing

CTLs contain modified lysosomes equipped with a battery of cytotoxic proteins, collectively called *cytotoxic granules*. Following activation of the CTL, the cytotoxic granules are driven at a rare old speed (up to $1.2\ \mu\text{m/s}$) along the microtubule system and delivered to the point of contact between the CTL and its target, the *immunological synapse* (Figure 8.30).

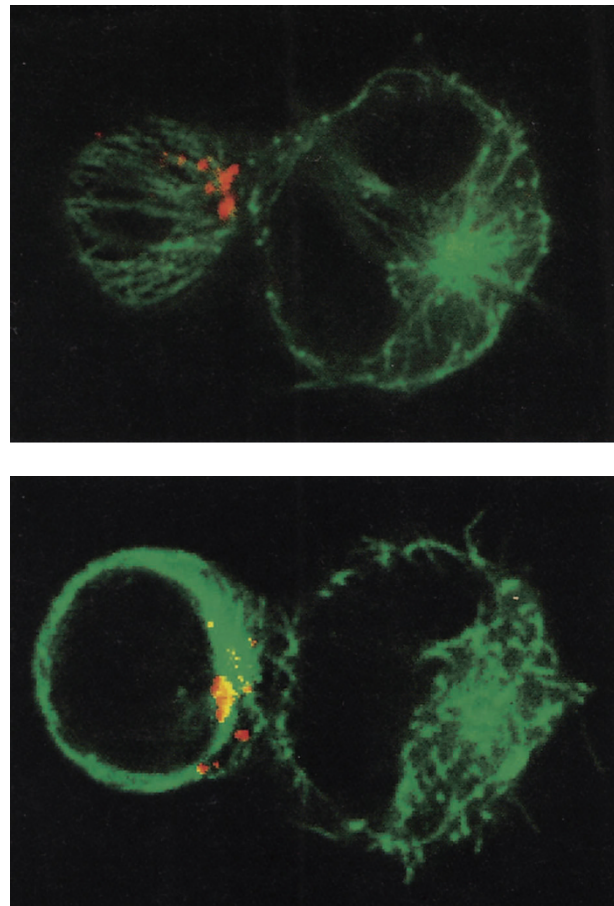


Figure 8.30 Conjugation of a cytotoxic T-cell (on left) to its target, here a mouse mastocytoma, showing polarization of the granules towards the target at the point of contact. The cytoskeletons of both cells are revealed by immunofluorescent staining with an antibody to tubulin (green) and the lytic granules with an antibody to granzyme A (red). Twenty minutes after conjugation the target cell cytoskeleton may still be intact (above), but this rapidly becomes disrupted (below). (Source: Dr. Gillian Griffiths. Reproduced with permission.)

Directed delivery of the cytotoxic granules towards the immunological synapse is important as this ensures the specificity of killing dictated by TCR recognition of the target and limits collateral damage to surrounding cells, as well as to the killer cell itself. As with NK cells, which have comparable granules, exocytosis of the cytotoxic granules delivers a range of cytotoxic proteins into the target cell cytosol that cooperate to promote apoptosis of the target (see Videoclip 3). Videomicroscopy shows that CTLs are serial killers. After the “kiss of death,” the T-cell can disengage and seek a further victim, there being rapid synthesis of new granules.

Cytotoxic T-cell granules contain *perforin*, a pore-forming protein similar to the C9 component of complement, and an array of cathepsin-like proteases that are collectively referred to as *granzymes*. Perforin facilitates the entry of the other granule

constituents into the target cell in a manner that is still much debated. One way in which perforin may deliver granzymes into the target cell is through oligomerization into a pore on the plasma membrane of the target, thereby permitting access of the granzymes to the cytosol (Figure 8.31). Indeed, pores of up to 20 nm in diameter can be formed within lipid membranes using purified perforin. An alternative mechanism that has been proposed involves the endocytosis of the cytotoxic granules by the target cell, with perforin facilitating escape of the granzymes from the endosomes into the target cell cytosol. Irrespective of the precise way in which perforin acts, it is clear that this pore-forming protein plays an essential role in the killing process; mice deficient in perforin are severely impaired in clearing several viral pathogens. In humans, congenital perforin deficiency results in the potentially fatal immunoregulatory disorder type 2 familial hemophagocytic lymphohistiocytosis (FHL), which is characterized by hyperactivation of T-cells and macrophages that infiltrate tissues and cause extensive damage as a result of overproduction of inflammatory cytokines. The latter symptoms also point towards a role for the perforin/granzyme pathway in an immunoregulatory context, such as we touched upon earlier in our discussion of the mechanism of action of Tregs (Figure 8.26).

It is not clear how all of the granzymes contribute to target cell death upon delivery into the cell cytoplasm, but granzymes A and B are known to play particularly significant roles in this process. Granzyme A can promote the activation of a nuclease through proteolysis of its inhibitor and this situation results in the formation of numerous single-stranded DNA breaks within the target cell (Figure 8.31). Granzyme B can directly process and activate several members of the *caspase* family of cysteine proteases that can rapidly initiate apoptosis through restricted proteolysis of hundreds of proteins within the target cell. Granzyme B can also promote caspase activation indirectly, through activation of Bid, a protein that promotes permeabilization of mitochondria and release of mitochondrial cytochrome *c* into the cytosol; the latter event arms a caspase-activating complex that has been termed “the apoptosome” and this complex promotes the activation of several downstream caspases (Figure 8.31). Several additional granzymes have also been found within cytotoxic granules but their precise functional role in CTL killing remains the subject of ongoing investigation. Collectively, entry of the full spectrum of granzymes into the target cells results in very swift cell killing (within 60 minutes or so) and several parallel pathways to apoptosis are most likely engaged during this process. CTLs also express protease inhibitors, such as PI-9, that may protect them from the lethal effects of their own granule contents.

Fas-dependent killing

CTLs are also endowed with a second killing mechanism involving Fas and its ligand (Figure 8.29). In this situation, engagement of the trimeric Fas receptor by membrane-borne Fas ligand on the CTL initiates a signaling pathway within the

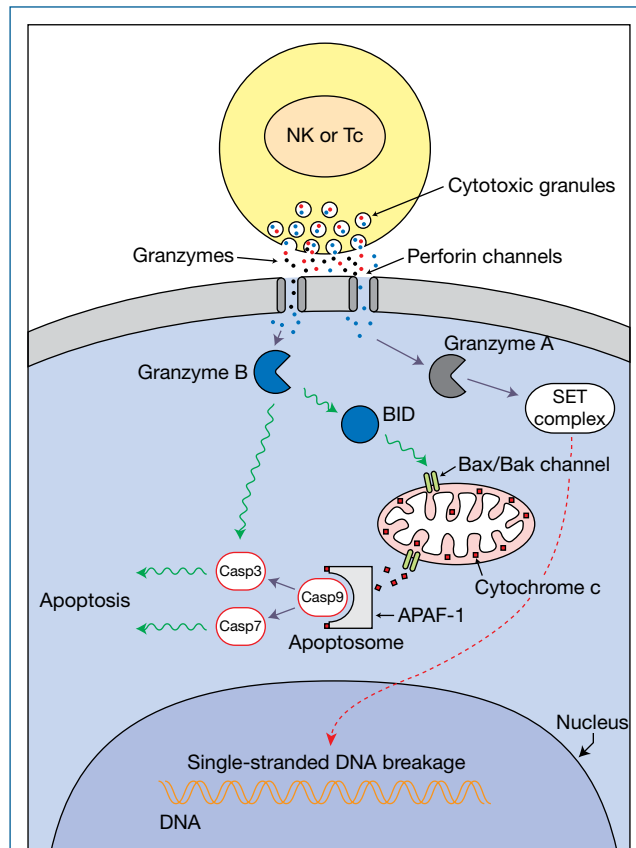


Figure 8.31 Cytotoxic granule-dependent killing of target cells by cytotoxic T-cells and NK cells. In response to an appropriate stimulus, Tc and NK cells deliver the contents of their cytotoxic granule onto the surface of target cells. The cytotoxic granule protein perforin is thought to polymerize within the target cell membrane forming pores that permit passage of other granule constituents, which includes several serine proteases (granzymes), into the target cell. Upon entry into the target, granzyme B orchestrates apoptosis by cleaving and activating BID, which translocates to mitochondria and triggers the opening of a pore or channel within the mitochondrial outer membrane composed of Bax and/or Bak; the latter channel permits the release of cytochrome *c* from the mitochondrial intermembrane space into the cytoplasm where it acts as a co-factor for the assembly of a caspase-9-activating complex (the apoptosome). The apoptosome promotes activation of downstream caspases, such as caspase-3 and caspase-7, and the latter proteases coordinate apoptosis through restricted proteolysis of hundreds of substrate proteins. Granzyme B can also proteolytically process and activate caspase-3 and caspase-7 directly, providing a more direct route to caspase activation. Another granule protein, granzyme A, can cleave a protein within the SET complex (an endoplasmic reticulum-associated protein complex). This permits the translocation of a nuclease (NM23-H1) to the nuclear compartment that can catalyze single-stranded DNA breaks. Cytotoxic granules also contain other granzymes that contribute to target cell killing but substrates for these proteases have yet to be identified.

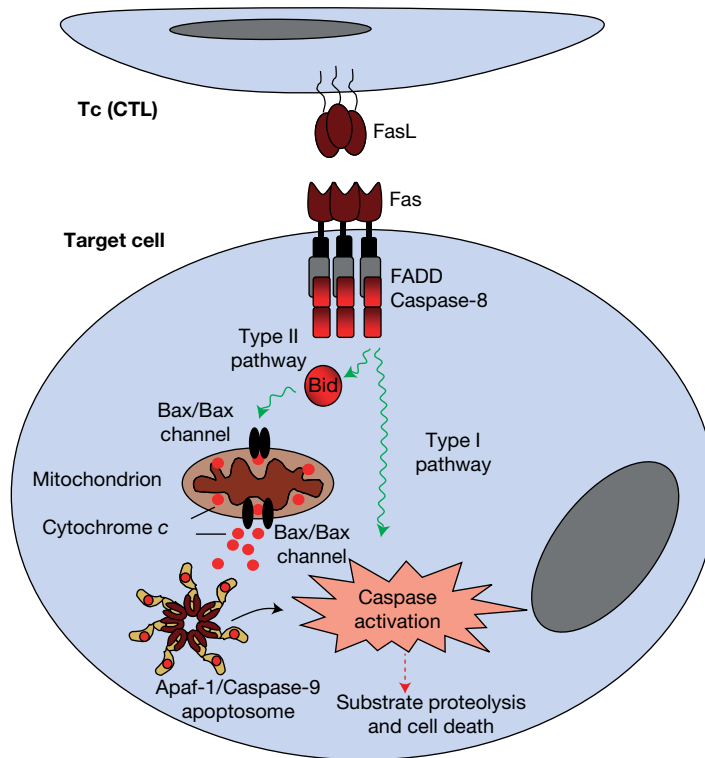


Figure 8.32 Fas–Fas ligand (FasL) route to apoptosis. Upon encounter of a Fas ligand (FasL)-bearing cell, susceptible cells undergo apoptosis through recruitment of caspase-8 to the cytoplasmic tail of the Fas receptor, via the adaptor protein FADD. Recruitment of caspase-8 to the receptor complex results in activation of this protease, which can then amplify downstream caspase activation, either directly (type I pathway) or indirectly by cleaving Bid and provoking cytochrome c release from mitochondria (type II pathway) that activates the Apaf-1/caspase-9 “apoptosome.” The apoptosome then promotes activation of downstream effector caspases that kill the cell.

target cell that results in the recruitment and activation of caspase-8 at the receptor complex (Figure 8.32). Upon activation, caspase-8 can further propagate the death signal through restricted proteolysis of Bid, similar to the granzyme B pathway discussed earlier, or can directly process and activate downstream caspases such as caspase-3. However, the inability of perforin knockout mice to clear viruses effectively suggests that the secretory granules provide the dominant means of killing virally infected cells. One should also not lose sight of the fact that CD8 cells synthesize other cytokines, such as TNF and IFN γ , that also have potent antiviral effects.

Caspase activation coordinates target cell death from within

As we have seen, the final common pathway to cell death involves the activation of members of the caspase family of proteases within the target cell, irrespective of whether killing has been initiated via the perforin/granzyme or Fas receptor pathway. Caspases kill cells through restricted proteolysis (i.e., by cutting proteins at only one or two sites) of literally *hundreds of substrate proteins*. To date, over 600 substrates for the apoptotic caspases have been identified using global proteomic analyses.

This “*death by a thousand cuts*” approach ensures that the failure to cleave a few proteins here or there is unlikely to allow a cell to escape from the clutches of these destructive enzymes once they have been set in motion. In addition to killing the target cell, caspases also trigger alterations to the plasma membrane that attract the attentions of local phagocytic cells, to promote clearance of the dying cell (Figure 8.33). Several plasma membrane alterations have been found to occur on apoptotic cells, most notably the externalization of phosphatidylserine, a phospholipid that is normally confined to the inner leaflet of the plasma membrane.

Apoptotic cells are rapidly cleared through phagocytosis

The induction of apoptosis, as opposed to necrosis, by the CTL is likely to have several benefits. Apoptotic cells, by virtue of the specific alterations to their plasma membranes mentioned in the preceding section, are swiftly recognized by macrophages and other phagocytic cells and undergo phagocytosis before their intracellular contents can leak. These membrane alterations promote the selective recognition and rapid engulfment of apoptotic cells by tissue-resident macrophages, as well as

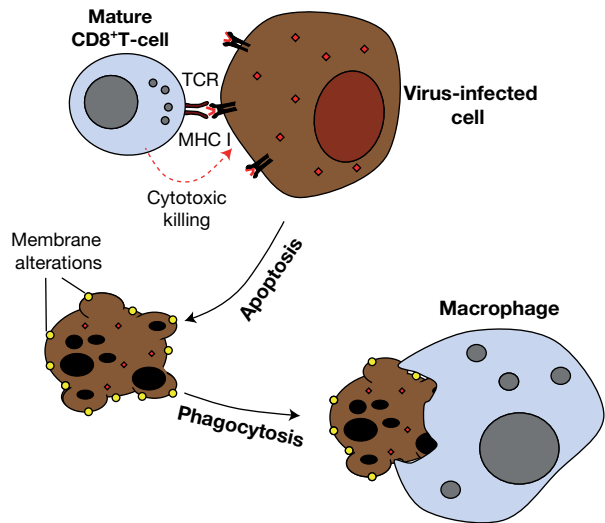


Figure 8.33 Apoptotic cells are rapidly recognized and removed by phagocytes. Apoptotic cells acquire multiple membrane alterations (phosphatidylserine externalization on the outer leaflet of the plasma membrane being one example) that enable professional as well as nonprofessional phagocytes to recognize and engulf such cells prior to membrane rupture and release of intracellular contents. In the context of cytotoxic T-cell (Tc) killing of a virus-infected cell, this may also prevent the release of viral particles that would otherwise occur if cell death took place via necrosis (i.e., cell rupture).

nonprofessional phagocytic cells (Figure 8.33). The rapid removal of apoptotic cells from a tissue has the desirable effect of minimizing collateral damage to neighboring cells and may also prevent escape of viral particles from an infected cell. Moreover, the nucleases and caspase proteases that become activated within the target cell during apoptosis are also likely to degrade viral nucleic acids and structural proteins and may also contribute to ensuring that infectious viral particle release is kept to a minimum.

Cytotoxic T-cells and NK cells may also kill intracellular and extracellular bacteria via the granzysin-dependent pathway

Recent evidence also suggests that CTL and NK cells may also exert cytotoxic activity against intracellular bacteria, such as *Listeria* and *Mycobacteria*, which infect and replicate in macrophages. The cytotoxic granules of human (but not rodent) CTL and NK cells also contain a pore-forming protein called granzysin that exerts modest antibacterial properties on its own. However, when combined with granzyme B, the cytotoxic activity of granzysin is dramatically enhanced, apparently through delivering granzyme B into the bacterium where it cleaves multiple proteins, including some within the bacterial electron transport chain. The latter event generates reactive oxygen that, in tandem with granzyme B-dependent proteolysis of

oxidative stress defense proteins within bacteria, is sufficient to kill the latter. Furthermore, activated CTL and NK cells are also known to release the contents of their cytotoxic granules into the extracellular space, making it feasible that these also contribute to the control of extracellular bacteria. As support for this idea, mice (which do not normally express granzysin) expressing transgenic granzysin are better able to clear *Listeria monocytogenes*. It is also worth noting that mast cells have been found to express granzymes, the function of which is relatively uncharacterized in such cells, and might also be capable of direct microbial killing in this manner.

Proliferation and maturation of B-cell responses are mediated by cytokines

Upon encounter with their cognate antigen, activated B-cells enter the cell cycle and undergo clonal proliferation to swell their ranks. Some of the activated B-cells will differentiate along extrafollicular routes to give rise to mainly short-lived plasma cells that undergo little somatic hypermutation in their BCRs. However, others will migrate to B-cell follicles and, under the guidance of Tfh cells, will undergo affinity maturation through acquiring point mutations in their BCRs, eventually differentiating into plasma cells that migrate to the bone marrow where they produce and secrete large amounts of antibody for relatively long periods. Let us look at these events in detail.

Upon successful DC-mediated activation of a T-helper cell within the T-cell areas of a lymph node, the activated T-cell then sets off, guided by chemokines, in search of a B-cell to provide help to. Within the B-cell areas of the lymph node, B-cells that have been activated through cross-linking of their surface immunoglobulin with cognate antigen presented on follicular dendritic cells require help from Th cells for full activation. To receive help, the B-cell needs to present the correct antigenic peptide to a T-cell that has already received stimulation by a DC. The activation of B-cells by Th cells, through the TCR recognition of MHC-linked antigenic peptide plus the co-stimulatory **CD40L-CD40 interaction**, leads to upregulation of the surface receptor for IL-4. Copious local release of this cytokine from the Th then drives powerful clonal proliferation and expansion of the activated B-cell population. IL-2 and IL-13 also contribute to this process (Figure 8.24).

Under the influence of IL-4 and IL-13, the expanded clones can differentiate and mature into IgE-synthesizing cells. TGF β and IL-5 encourage cells to switch their Ig class to IgA. IgM plasma cells emerge under the tutelage of IL-4 plus IL-5, and IgG producers result from the combined influence of IL-4, -5, -6, -13, and IFN γ (Figure 8.24).

Type 2 thymus-independent antigens can activate B-cells directly but nonetheless still need cytokines for efficient proliferation and Ig production. These may come from accessory cells such as NK and NKT cells that bear lectin-like receptors.

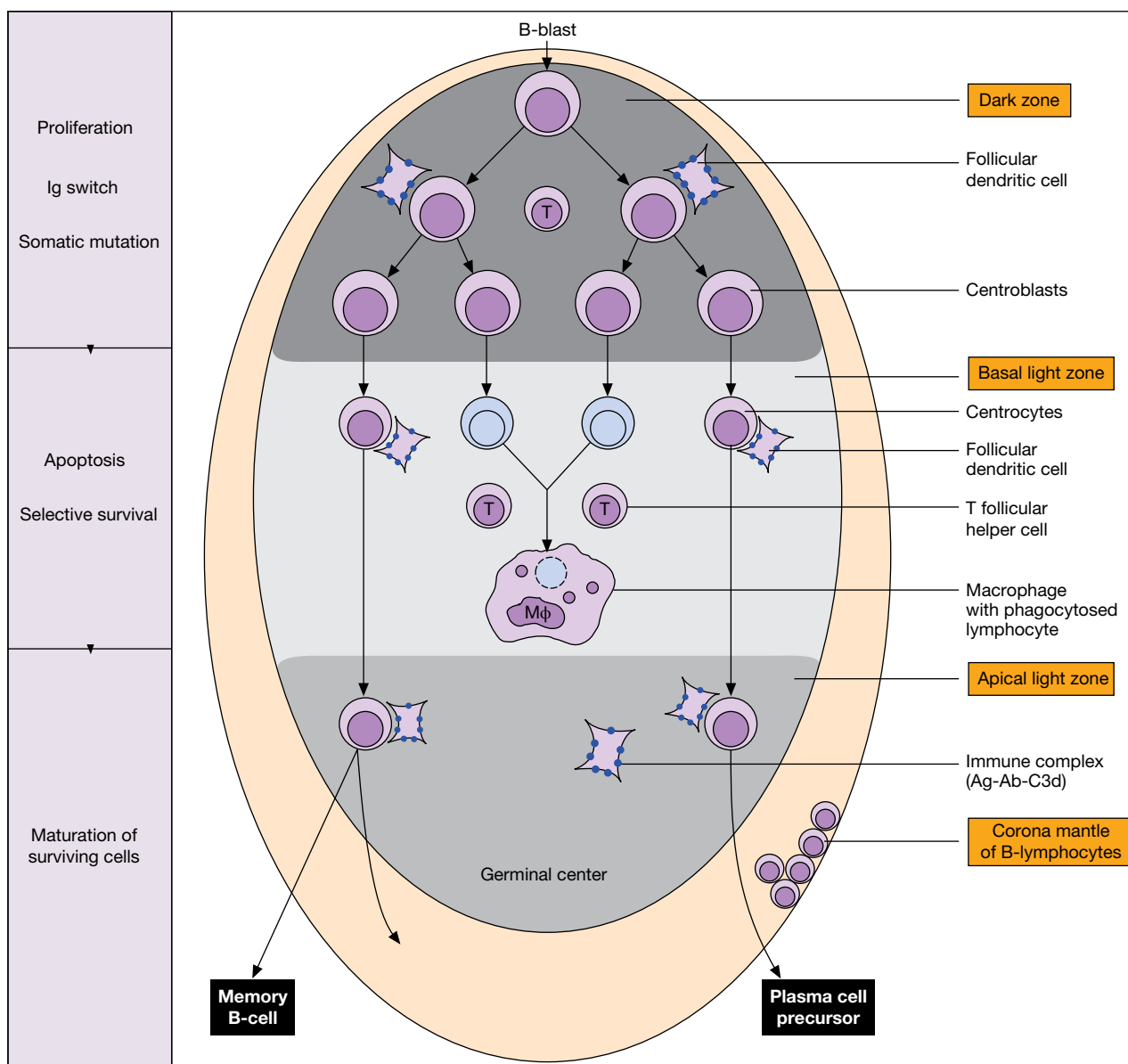


Figure 8.34 The events occurring in lymphoid germinal centers. Germinal center B-cells can be enriched through their affinity for the peanut agglutinin lectin. They show numerous mutations in the antibody genes. Expression of LFA-1 and ICAM-1 on B-cells and follicular dendritic cells (FDCs) in the germinal center makes them “sticky.” Centroblasts at the base of the follicle are strongly CD77 positive. The Th cells bear the unusual CD57 marker. The FDCs all express CD21 and CD54; those in the apical light zone are strongly CD23 positive, those in the basal light zone express little CD23. Through their surface receptors, FDCs bind immune complexes containing antigen and C3 that, in turn, are very effective B-cell stimulators as co-ligation of the surface receptors for antigen and C3 (CR2) lowers their threshold for activation. The co-stimulatory molecules CD40 and B7 play pivotal roles. Antibodies to CD40 prevent formation of germinal centers and anti-CD40L can disrupt established germinal centers within 12 hours. Anti-B7.2, given early in the immune response, prevents germinal center formation and, when given at the onset of hypermutation, suppresses that process.

What is going on in the germinal center?

Recall from Chapter 6 that *germinal centers (GCs) are the sites of antigen-dependent clonal expansion, diversification, and affinity maturation of B-cells*, all of which are required for the generation of the high-affinity antibodies that play critical

roles in humoral immune responses. In essence, what happens in the germinal centers *is a controlled process of rapid B-cell evolution (through mutation of their BCRs), overseen by follicular T-helper cells that select the highest affinity B-cells on the basis of their ability to capture antigen from follicular dendritic cells (FDCs).*

In the absence of antigen, B-cells within lymph nodes reside primarily within primary follicles composed of a mesh of FDCs, the spaces between which are packed with resting, small B-lymphocytes. However, upon encounter with T-dependent antigen, the primary follicles undergo a transformation into secondary follicles, as antigen-specific B-cells undergo rapid clonal proliferation and crowd around the FDC network, displacing resting B-cells into the periphery or mantle of the follicle. This separation divides the GC into two anatomically distinct regions: a dark zone (DZ), containing large, mitotically active B-cells known as *centroblasts*; and a light zone (LZ), containing smaller, nondividing B cells known as *centrocytes*, as well as antigen deposited on the surface of follicular dendritic cells (FDCs) and antigen-specific *follicular T helper cells* which are critical for generation and maintenance of follicles (Figure 8.34).

This segregation between the area of cell division and potential selecting agents (i.e., antigen-bearing FDCs and follicular helper T-cells) suggests a model in which selection of high-affinity B-cells requires the migration of cells between the two zones, the DZ acting as a location of B-cell proliferation and mutation, followed by antigen presentation and selection (i.e., co-stimulation via CD40L and cytokines provided by Tfh cells) in the LZ, with B-cells possibly returning to the DZ for multiple rounds of proliferation and mutation. During the frenetic cycles of cell division in the DZ, *somatic hypermutation* of B-cell Ig genes occurs. The cells also undergo *Ig class switching*. Thereafter, as they transform to centrocytes and return to the LZ, they are vulnerable and die readily, whence they are taken up as the “tingible bodies” by macrophages, unless rescued by a Tfh in the LZ. This could result from cross-linking of surface Ig receptors and is accompanied by expression of Bcl-x and Bcl-2 that protect against apoptosis. Interactions between BAFF (B-cell-activating factor of the tumor necrosis factor family; also called BLyS) on the Tfh cell and TACI (transmembrane activator and calcium modulator and cyclophilin ligand [CAML] interactor), its receptor on the B-cell may also be important for the maintenance of germinal center B-cells. Signaling through CD40 and TACI, during presentation of antigen to Tfh cells, would also appear to prolong the life of the centrocyte.

What is the reason for the physical separation of B-cells into light and dark zones within the GC?

Although the mysteries of B-cell trafficking between dark and light zones are still the subject of ongoing investigation, *the major practical reason for this separation appears to be to minimize the depletion of antigen*, which would rapidly occur if clonal expansion of B-cells bearing antigen-specific BCRs was permitted in the same area used to select the highest affinity BCRs for further rounds of expansion. Although an early model suggested that B-cells with high-affinity receptors are selected simply as a consequence of BCR cross-linking by antigen deposited as immune complexes on the surface of

FDCs, more recent data suggest that GC B-cells use their BCRs to capture and internalize antigen for presentation to GC-resident Tfh cells. Tfh cells can then influence B-cell selection through providing help in the form of cytokine secretion and CD40L. Therefore, *B-cell clonal expansion is controlled by limited numbers of Tfh cells in the LZ that give help to B-cells that have captured and internalized the most antigen*. The role of the BCR in this scenario is not to provide stimulation *per se*, but to capture antigen from FDCs, with BCR affinity dictating the relative amount of antigen captured. Thus, there is a competition between follicular B-cells for Tfh cell-mediated help, with Tfh cells discerning between LZ B-cells based on the amount of antigen captured and presented. The more antigen captured by a B-cell, and presented on MHC class II to Tfh cells, the more likely it is to receive help from a Tfh cell and therefore undergo further rounds of proliferation and somatic hypermutation in the LZ. In agreement with the latter scenario, fewer than 5% of GC B-cells form stable conjugates with GC Tfh cells and those that do form stable conjugates trigger rapid CD40L externalization on Tfh cells, leading to increased ICOSL expression on the B-cell, which reinforces Tfh stability. Thus, Tfh cell help, and not direct competition for antigen on FDCs, appears to be the limiting factor in GC selection.

Of course, Tfh–B-cell interactions will only occur if the mutated surface Ig receptor still binds antigen and, as the concentration of antigen gradually falls, only if the receptor is of high affinity. In other words, the system can deliver high-affinity antibody by a Darwinian process of high-frequency mutation of the Ig genes and selection, by antigen, of the cells bearing the antibody that binds most strongly (Figure 8.35). This increase of affinity as the antibody level falls late in the response is of obvious benefit, as a small amount of high-affinity antibody can do the job of a large amount of low-affinity antibody (as in boxing, a small “goodun” will generally be a match for a mediocre “bigun”).

Further differentiation now occurs. The cells either migrate to the sites of plasma cell activity (e.g., lymph node medulla) or go to expand the memory B-cell pool, depending upon the cytokine and other signals received.

Plasma cells migrate to specialized niches under the guidance of chemokines

Throughout rounds of proliferation, a fraction of B-cells undergo differentiation and leave the germinal centers as either plasma cells or memory B-cells. The emigration of plasma cells from secondary lymphoid organs is mediated by the induction of sphingosine 1-phosphate receptor on plasma cells, whereas expression of the chemokine receptor CXCR4 promotes the recruitment of plasma cells into bone marrow niches and contributes to the positioning of plasma cells near bone marrow stromal cells expressing the chemokine CXCL12. Both memory B-cells and plasma cells have the capacity for longevity; the lifespan of plasma cells can reach years in mice and decades in

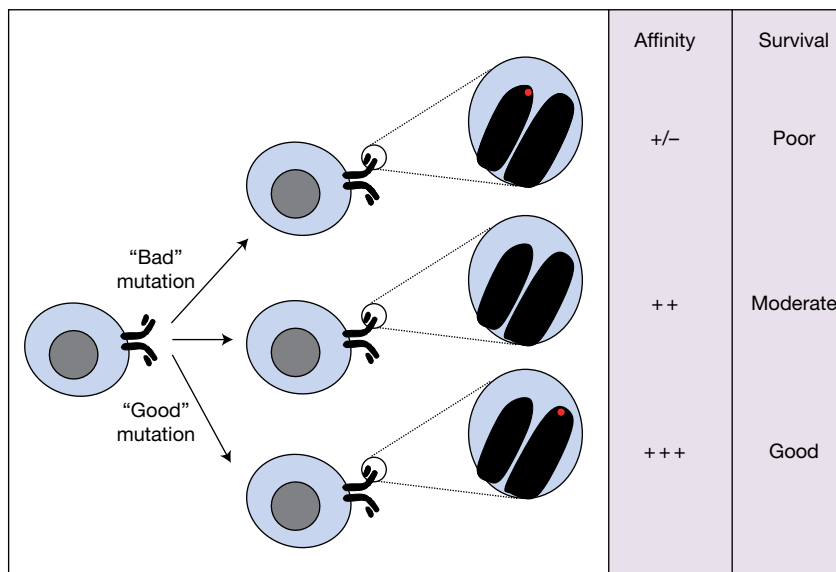


Figure 8.35 Darwinian selection by antigen of B-cells with antibody mutants of high affinity protects against cell death in the germinal center, either through cross-linking of sIg by antigen on follicular dendritic cells, or through Th cell recognition of processed antigen and signaling through CD40. In both cases, capture of antigen, particularly as the concentration falls, will be critically affected by the affinity of the surface receptor.

humans, and they provide protective antibodies for a lifetime in some cases. To achieve such longevity, plasma cells must locate themselves in specialized niches composed of cells that provide the signals necessary to maintain plasma cell viability.

Plasma cell survival is sustained through cytokines that upregulate anti-apoptotic molecules

In niches that promote the persistence of plasma cells, these cells receive cytokine-mediated signals from local stromal cells that are crucial for their long-term survival. These signals include ligands for the receptor BCMA, which include APRIL (a proliferation-inducing ligand) and BAFF (a B-cell-activation factor), as well as IL-4, IL-5, IL-6, and TNF, CD44 ligands, and CXCL12. Many of the latter promote the expression of antiapoptotic proteins of the Bcl-2 family, but expression of Mcl-1 in particular appears to be critical as deletion of *Mc11* led to rapid disappearance of plasma cells in the mouse.

The synthesis of antibody

The sequential processes by which secreted Ig arises are illustrated in Figure 8.36. In the normal antibody-forming cell there is a rapid turnover of light chains that are present in slight excess. Defective control occurs in many myeloma cells and one may see excessive production of light chains or complete suppression of heavy chain synthesis.

The variable and constant regions are spliced together in the mRNA before leaving the nucleus. Differential splicing

mechanisms also provide a rational explanation for the coexpression of surface IgM and IgD, with identical V regions on a single cell, and for the switch from production of membrane-bound IgM receptor to secretory IgM in the antibody-forming cell (see Figure 4.2 and Figure 4.3).

Immunoglobulin class switching occurs in individual B-cells

The synthesis of antibodies belonging to the various immunoglobulin classes proceeds at different rates. Usually there is an early IgM response that tends to fall off rapidly. IgG antibody synthesis builds up to its maximum over a longer time period. On secondary challenge with antigen, the time-course of the IgM response resembles that seen in the primary. By contrast, the synthesis of IgG antibodies rapidly accelerates to a much higher titer and there is a relatively slow fall-off in serum antibody levels (Figure 8.37). The same probably holds for IgA, and in a sense both these immunoglobulin classes provide the main immediate defense against future penetration by foreign antigens.

As we saw in Chapters 3 and 4, individual B-cells can switch over from IgM to IgG production. For example, antigen challenge of irradiated recipients receiving relatively small numbers of lymphoid cells produced splenic foci of cells, each synthesizing antibodies of different heavy chain class bearing a single idio type; the common idio type suggests that each focus is derived from a single precursor cell whose progeny can form antibodies of different class.

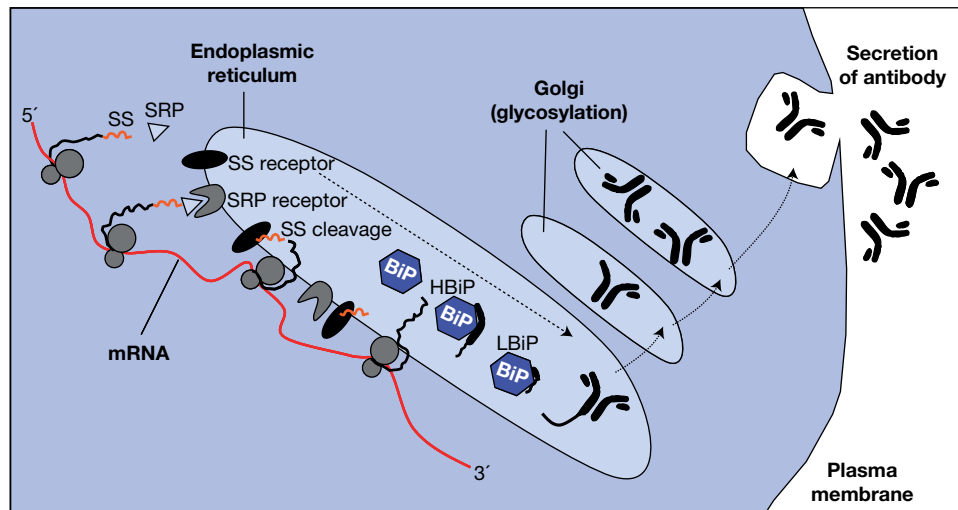


Figure 8.36 Synthesis of immunoglobulin. As mRNA is translated on the ribosome, the N-terminal signal sequence (SS) is bound by a signal recognition particle (SRP) that docks onto a receptor on the outer membrane of the endoplasmic reticulum (ER) and facilitates entry of the nascent Ig chain into the ER lumen. The SS associates with a specific membrane receptor and is cleaved; the remainder of the chain, as it elongates, complexes with the molecular chaperone BiP (immunoglobulin-binding protein) that binds to the heavy chain C_H1 and V_L domains to control protein folding. The unassembled chains oxidize and dissociate as the full H_2L_2 Ig molecule. The assembled H_2L_2 molecules can now leave the ER for terminal glycosylation in the Golgi and final secretion. Surface receptor Ig would be inserted by its hydrophobic sequences into the membrane of the endoplasmic reticulum as it was synthesized.

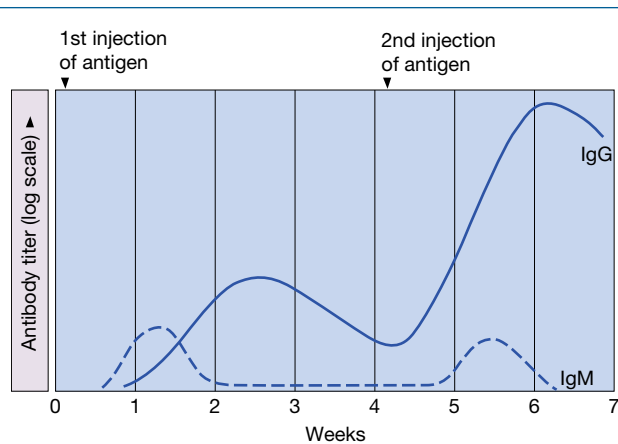


Figure 8.37 Synthesis of IgM and IgG antibody classes in the primary and secondary responses to antigen.

Antibody synthesis in most classes shows considerable dependence upon T-cell cooperation in that the responses in T-deprived animals are strikingly deficient; such is true of mouse IgG1, IgG2a, IgA, IgE, and part of the IgM antibody responses. T-independent antigens such as the polyclonal activator lipopolysaccharide (LPS) endotoxin induce synthesis of IgM with some IgG2b and IgG3. Immunopotentiality by complete Freund's adjuvant, a water-in-oil emulsion containing antigen in the aqueous phase and a suspension of killed tubercle bacilli in the oil phase, seems to occur, at least in part

through the activation of Th cells that stimulate antibody production in T-dependent classes. The prediction from this, that the response to T-independent antigens (e.g., *Pneumococcus* polysaccharide) should not be potentiated by Freund's adjuvant, is borne out in practise; furthermore, as mentioned previously, these antigens evoke primarily IgM antibodies and poor immunological memory, as do T-dependent antigens injected into T-cell-deficient, neonatally thymectomized hosts.

Thus, in rodents at least, the switch from IgM to IgG and other classes appears to be largely under T-cell control critically mediated by CD40 and by cytokines, as we have discussed earlier. Let us take another look at the stimulation of small, surface IgM-positive, B-cells by LPS. As we noted, on its own, the nonspecific mitogen evokes the synthesis of IgM, IgG3, and some IgG2b. Following addition of IL-4 to the system, there is class switching from IgM to IgE and IgG1 production, whereas IFN γ stimulates class switching from IgM to IgG2a and TGF β induces switching from IgM to IgA or IgG2b. These cytokines induce the formation of germline sterile transcripts that start at the I (initiation) exon 5' of the switch region for the antibody class to which switching will occur and terminate at the polyadenylation site 3' of the relevant C_H gene (Figure 8.38). The transcripts are not translated but instead remain associated with the template DNA, forming RNA-DNA hybrids within the S regions of the DNA that might act as targets for enzymes involved in the recombination process. Under the influence of the recombinase, a given VDJ gene segment is transferred from μ D to the new constant region gene (Figure 8.38), so yielding antibodies of the same specificity but of different class.

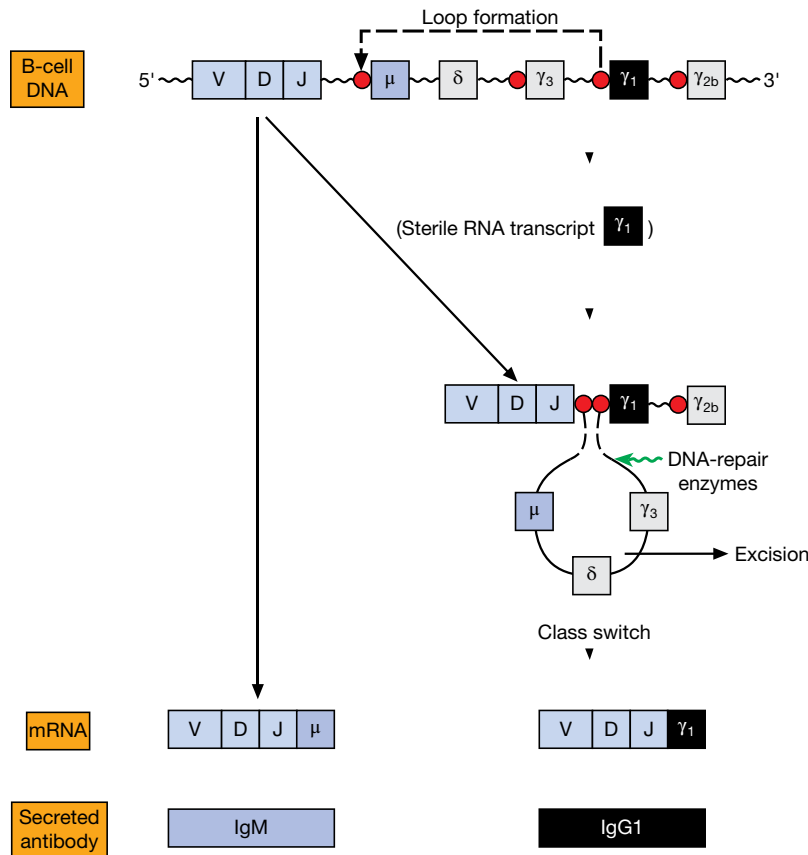


Figure 8.38 Class switching to produce antibodies of identical specificity but different immunoglobulin isotype (in this example from IgM to IgG1) is achieved by a recombination process that utilizes the specialized switch sequences (●) and leads to a loss of the intervening DNA loop (μ , δ , and γ_3). Each switch sequence is 1–10 kilobases in length and comprises guanosine-rich repeats of 20–100 base-pairs. Because the switch sequence associated with each C_H gene has a unique nucleotide sequence, recombination cannot occur homologically and therefore probably depends upon nonhomologous end joining. DNA-repair proteins, including Ku70, Ku80, and the catalytic subunit of the DNA-dependent protein kinase (DNA-PK_{CS}), are involved in this process.

Class-switched B-cells are subject to high mutation rates after the initial response

The reader will no doubt recollect that this idea was raised in Chapters 3 and 4 when discussing the generation of diversity, and that the germinal center has been identified as the site of intense mutagenesis, which is catalyzed by activation-induced cytidine deaminase (AID). The latter removes an amino (NH_2) group from deoxycytidine within DNA, triggering a modified DNA-repair reaction that results in mutation of this base to any one of the four nucleotides. This reaction takes place within certain hot-spots in Ig genes, guided by sequence motifs as well as chromatin modifications, such that AID-dependent mutations occur preferentially within V regions. The normal V-region mutation rate is of the order of 10^{-5} /base-pair per cell division, but this rises to 10^{-3} /base-pair per generation in B-cells as a result of antigenic stimulation. This process is illustrated in Figure 8.39 that charts the accumulation of somatic mutations in the immunodominant V_H/V_k antibody structure during the immune response to phenylazalone. With time and successive boosting, the mutation rate

is seen to rise dramatically and, in the context of the present discussion, it is clear that the strategically targeted hypermutations occurring within or adjacent to the complementarity determining hypervariable loops (Figure 8.40) can give rise to cells that secrete antibodies having a different combining affinity to that of the original parent cell. Randomly, some mutated daughter cells will have higher affinity for antigen, some the same or lower and others perhaps none at all (see Figure 8.35). Similarly, mutations in the framework regions may be “silent” or, if they disrupt the folding of the protein, give rise to nonfunctional molecules. Pertinently, the proportion of germinal center B-cells with “silent” mutations is high early in the immune response but falls dramatically with time, suggesting that early diversification is followed by preferential expansion of clones expressing mutations that improve their chances of reacting with and being stimulated by antigen. B-cells expressing mutated antibodies that now fail to recognize antigen undergo apoptosis, as continued antigenic stimulation via the B-cell receptor is required for B-cell survival during this phase.

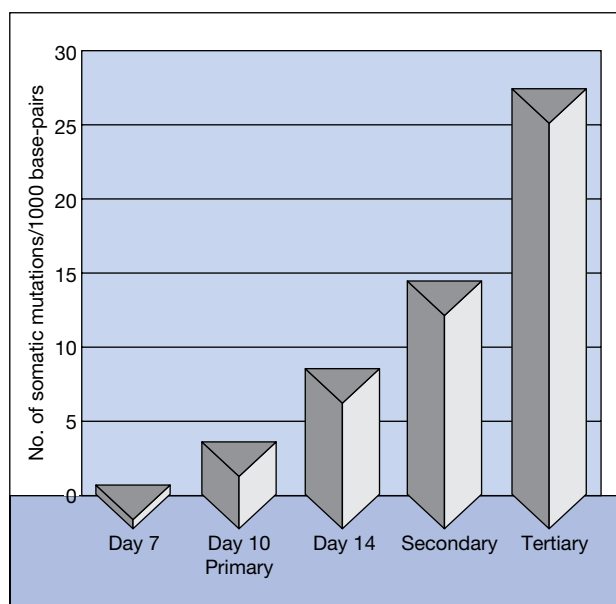
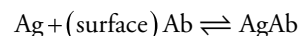


Figure 8.39 Increasing somatic mutations in the immunodominant germline antibody observed in hybridomas isolated following repeated immunization with phenylloxazalone. (Data source: Berek C. and Apel M. (1989) In Melchers F. *et al.* (eds.) *Progress in Immunology* 7, 99. Springer-Verlag, Berlin.)

Factors affecting antibody affinity in the immune response

The effect of antigen dose

Other things being equal, the binding strength of an antigen for the surface receptor of a B-cell will be determined by the affinity constant of the reaction:



and the reactants will behave according to the laws of thermodynamics.

It may be supposed that, when a sufficient number of antigen molecules are bound to the receptors on the cell surface and processed for presentation to T-cells, the lymphocyte will be stimulated to develop into an antibody-producing clone. When only small amounts of antigen are present, only those lymphocytes with high-affinity receptors will be able to bind sufficient antigen for stimulation to occur and their daughter cells will, of course, also produce high-affinity antibody. Consideration of the antigen–antibody equilibrium equation will show that, as the concentration of antigen is increased, even antibodies with relatively low affinity will bind more antigen; therefore, at high doses of antigen, the lymphocytes with lower affinity receptors will also be stimulated and, as may be seen from Figure 8.41,

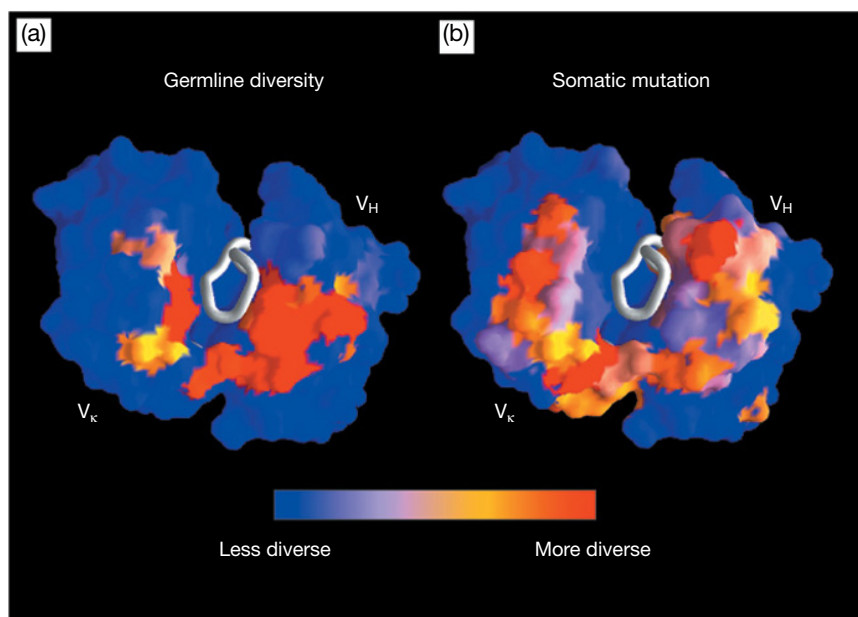


Figure 8.40 An “antigen’s eye view” of sequence diversity in human antibodies. The sequence diversity has been plotted on a scale of blue (more conserved) to red (more diverse). The V_H domain is on the right and the V_K domain on the left in both pictures. (a) Germline diversity prior to somatic hypermutation is focused at the center of the antigen-binding site. (b) Somatic hypermutation spreads diversity to regions at the periphery of the binding site that are highly conserved in the germline V gene repertoire. Somatic hypermutation is therefore complementary to germline diversity. The V_H CDR3, which lies at the center of the antigen-binding site, was not included in this analysis and therefore is shown in gray as a loop structure. The end of the V_K CDR3 (also excluded) lies at the center of the binding site and is not visible in this representation. (Source: Tomlinson I.M. *et al.* (1996) *Journal of Molecular Biology* 256, 813. Reproduced with permission of Elsevier.)

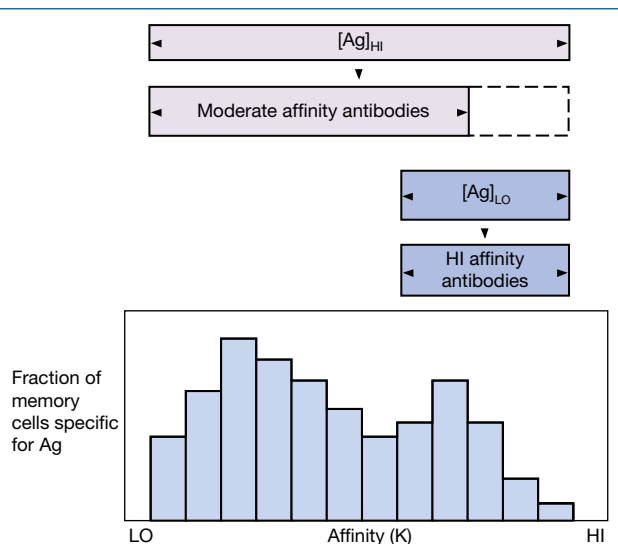


Figure 8.41 Relationship of antigen concentration to affinity of antibodies produced. Low concentrations of antigen ($[Ag]_{LO}$) bind to and permit stimulation of a range of high-affinity memory cells and the resulting antibodies are of high affinity. High doses of antigen ($[Ag]_{HI}$) are able to bind sufficiently to the low-affinity cells and thereby allow their stimulation, while the highest affinity cells may bind an excess of antigen and be tolerized (dashed line); the resulting antiserum will have a population of low- to moderate-affinity antibodies.

these are more abundant than those with receptors of high affinity. Furthermore, there is a strong possibility that cells with the highest affinity will bind so much antigen as to become tolerized. Thus, in summary, low amounts of antigen produce high-affinity antibodies, whereas high antigen concentrations give rise to an antiserum with low-to-moderate affinity.

Maturation of affinity

In addition to being brisker and fatter, secondary responses tend to be of higher affinity. There are probably two main reasons for this maturation of affinity after primary stimulation. First, once the primary response gets under way and the antigen concentration declines to low levels, only successively higher affinity cells will bind sufficient antigen to maintain proliferation. Second, at this stage the cells are mutating madly in the germinal centers, and any mutants with an adventitiously higher affinity will bind well to antigen on FDCs and be positively selected for by its persistent clonal expansion. Modification of antibody specificity by somatic point mutations allows gradual diversification on which positive selection for affinity can act during clonal expansion.

It is worth noting that responses to thymus-independent antigens, which have poorly developed memory with very rare mutations, do not show this phenomenon of affinity maturation. Overall, the ability of Th to facilitate responses to nonpolymeric, nonpolyclonally activating antigens, to

induce expansive clonal proliferation, to effect class switching and, lastly, to fine-tune responses to higher affinity has provided us with bigger, better and more flexible immune responses.

Memory cells

As the immune response subsides, the majority of recently expanded effector cells are culled by large-scale induction of apoptosis in this population. In Chapter 7, we discussed the important role of Fas–Fas ligand interactions in this process and how activated effector T-cells become susceptible to Fas ligand-bearing cells as they age. The source of Fas ligand that is responsible for eliminating recently expanded T-cells can be the T-cell itself, thus activated T-cells can kill themselves in an autocrine (i.e., suicidal) manner, or can be killed by neighboring T-cells bearing Fas ligand in a paracrine (i.e., fratricidal) manner. Whereas both naive as well as activated T-cells express the Fas receptor, the former are protected from the cell-killing effects of Fas ligand due to the expression of a molecule (FLIP) that disrupts the signaling cascade downstream of receptor stimulation that would otherwise activate the cell-killing properties of this cascade. B-cells are also susceptible to Fas ligand-dependent killing, particularly if they fail to receive CD40L-dependent stimulation from a cognate Th2 or Tfh cell. However, a subpopulation of cells escape the culling process and these form the **memory compartment** that live to mount a more rapid and efficient secondary immune response upon re-exposure to the same antigen. It is possible that the memory cell population represents a subpopulation of cells that bypass the effector cell stage entirely, but this concept remains a subject of debate. The process of memory cell generation is central to the concept of vaccination and memory cells have been the subjects of much investigation as a consequence.

The generation of memory

It is not clear whether memory cells and effector cells are derived from the same cell compartment or represent distinct differentiation trajectories of activated lymphocytes. There are two main schools of thought regarding memory generation. In the first (the off–on–off model), memory cells are derived from effector cells and are a population of antigen-experienced lymphocytes left over after an infection has been resolved (Figure 8.42). In this model, differentiated effector cells somehow switch off production of their effector molecules and differentiate to a memory state. This scenario argues that memory cells are derived from effector cells which is at odds with some data regarding the number of cell divisions that the latter have undergone compared with the former. In the second (the developmental model), memory cells are generated as a distinct population in parallel with effector cell generation and this may be a consequence of such cells receiving less antigenic stimulation than lymphocytes that differentiate into effectors. The latter model is attractive as it predicts that as antigen disappears from the system, memory cell generation would be

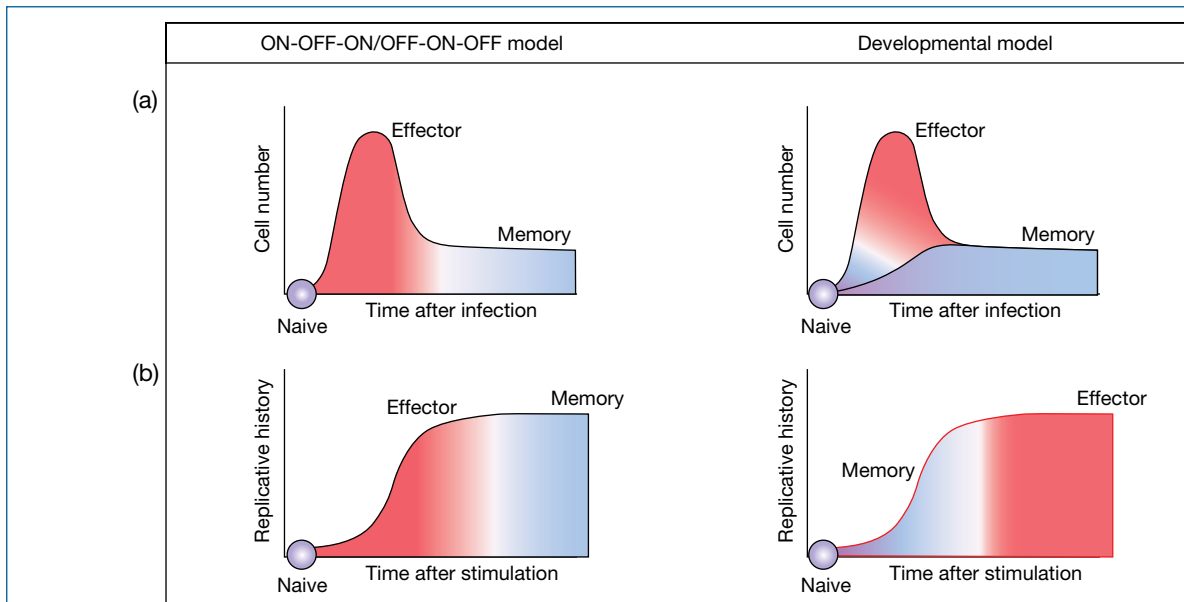


Figure 8.42 Two models of memory cell generation. Two of the possible models of memory lymphocyte generation are (left) the “off-on-off” model, in which all memory T-cells are derived from effector cells that become memory cells towards the end of an immune response and (right panels) the “developmental” model, whereby memory cells arise from naive precursors as an alternative differentiation trajectory without first going through an effector stage. (Source: Restifo N.P. and Gattinoni L. (2013) *Current Opinion in Immunology* 25, 556–563. Reproduced with permission of Elsevier.)

increased as a result of lymphocytes receiving lower concentrations of antigen-dependent stimulation than may be necessary for the generation of full-blown effector cells (Figure 8.42). Thus, it may be the intensity of antigen-driven lymphocyte stimulation that dictates whether a cell becomes a memory or an effector cell. Thus, as an infection is cleared, the production of effectors would decline and that of memory cells would naturally increase (Figure 8.42).

It has also been suggested that memory and effector cells may be demarcated through *asymmetric division* of T-cells upon productive stimulation with antigen (Figure 8.43). In this model, the cell pole nearest to the immunological synapse (i.e., the point at which the T-cell and DC or target cell make productive TCR–peptide/MHC interactions) may have a distribution of *cell fate determinants* (i.e., transcription factors) different to the opposite cell pole. The distribution of cell fate determinants within a cell can be regulated by polarity complex proteins. Subsequent division of the activated T-cell may distribute such cell fate determinants asymmetrically between daughter cells, and this could set up the subsequent effector versus memory cell differentiation trajectories (Figure 8.43). There is some evidence to support such a model, with the polarity complex protein Scribble associating with the immunological synapse, whereas another polarity complex protein, PKC ζ , has been found to associate with the opposite cell pole. Furthermore, some studies have reported that the daughter cell inheriting the immunological synapse had greater expression levels of LFA-1 and became effector cells, with the other cell

pole becoming memory cells (Figure 8.43). However, there is also evidence that effector cells can become memory cells, so the issue is not clear-cut. Indeed, memory cell generation may utilize a number of different mechanisms involving all three strategies discussed above.

Is antigen persistence required for the maintenance of memory?

Antibodies encoded by unmutated germline genes represent a form of evolutionary memory, in the sense that they tend to include specificities for commonly encountered pathogens and are found in the so-called “natural antibody” fraction of serum. Memory acquired during the adaptive immune response requires contact with antigen and expansion of antigen-specific memory cells, as seen for example in the 20-fold increase in cytotoxic T-cell precursors after immunization of females with the male H-Y antigen.

Memory of early infections such as measles is long-lived and *the question arises as to whether the memory cells are long-lived or are subject to repeated antigen stimulation from persisting antigen or subclinical reinfection*. Peter Panum in 1847 described a measles epidemic on the Faroe Islands in the previous year in which almost the entire population suffered from infection except for a few old people who had been infected 65 years earlier. While this evidence favors the long half-life hypothesis, memory function of B-cells transferred to an irradiated syngeneic recipient is lost within a

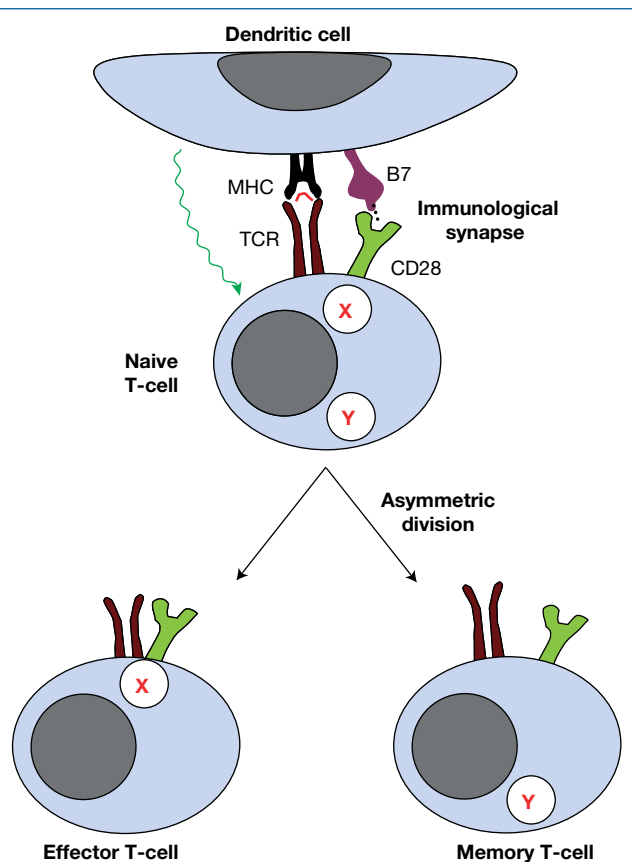


Figure 8.43 Asymmetric cell division may contribute to the generation of effector versus memory cells. A possible mechanism for the generation of effector versus long-lived memory T-cells is through asymmetric division of activated naive T-cells owing to unequal distribution of cell fate determinants, designated “X” and “Y” here for illustrative purposes, that can influence cell fate commitment. Cell fate determinants could be transcription factors that can commit cells to distinct differentiation pathways and may be unequally segregated within cells as a result of tethering to different polarity complex proteins that restrict their free diffusion. In this figure, cell fate determinant “X” is tethered close to the immunological synapse and specifies an effector cell fate upon subsequent cell division. In contrast, cell fate determinant “Y” is tethered at the opposite pole and commits the cell to a memory fate upon subsequent division.

month unless antigen is given or the donor is transgenic for the *bcl-2* gene (remember that signals in the germinal center that prevent apoptosis of centrocytic B-cells also upregulate *bcl-2* expression). It is envisaged that B-cell memory is a dynamic state in which survival of the memory cells is maintained by recurrent signals from FDCs in the germinal centers, the only long-term repository of antigen.

Evidence from mouse models strongly suggests that *memory T-cells can, at least in principle, persist in the absence of antigen*. T-cells isolated from mice several months after they were immunized with lymphocytic choriomeningitis virus

(LCMV) were transferred into two groups of genetically modified mice that lacked endogenous T-cells, one of the groups additionally lacking MHC class I expression. T-cells were parked in these mice for 10 months and then analyzed *in vitro*. Functional virus-specific CD8⁺ CTLs were still present in both groups of mice, and in similar numbers, even though those from the class I⁻ mice could not have had antigen presented to their TCR. Indeed, these memory T-cells undergo antigen- and MHC-independent proliferation *in vivo*, their numbers controlled, at least in part, by a balance between proliferation-inducing signals from IL-15 and cell death-inducing signals from IL-2 released in the local environment, both cytokines binding to the IL-2R β chain (see Figure 8.4). Other recent findings indicate that helper T-cell memory also does not require the continued presence of antigen or MHC and, at least in some cases, Th memory is maintained in the absence of cell division.

However, we should not lose sight of the fact that, while these experiments in transgenic and knockout animals clearly demonstrate that immunological memory *can* be maintained in the absence of antigen, usually antigen persists as complexes on FDCs. Therefore, there is the potential for APCs within the germinal center to capture and process this complexed antigen and then present it to memory T-cells. Some evidence also suggests that it is a type of dendritic cell, and not the germinal center B-cells, that may subserve this function. To add complexity, there is also accumulating evidence that the mechanisms used to maintain memory T-cells in the mouse, a relatively short-lived animal, may differ significantly from those employed by the human immune system. ***Specific antigen may play a much more important role in maintaining T-lymphocyte memory in humans, not least because ongoing entry of new memory cells specific for diverse antigens to the memory compartment will generate competition between memory cells.*** Because the naive and memory cell pools are maintained at a relatively constant size, it is likely that memory cells that receive periodic re-stimulation with antigen are likely to persist for longer than those that fail to re-encounter antigen. Competition may be absent or diminished in mouse models where animals are typically maintained in artificially clean environments; such cossetting is likely to reduce the rate of entry of new T-cell specificities to the memory compartment and therefore reduce competition between memory cell populations. In support of this view, while there is evidence that T-cell memory in humans can persist for decades after exposure to particular antigens, immunity does indeed decline over time and estimates of the half-life of T-cell responses have put this between 8 and 15 years. In addition, because the lifespan of the laboratory mouse is far shorter than that of the average human, the problems associated with retention of memory cells in the human are likely to be greater than those faced by laboratory mice. Ongoing attrition of memory T-cells, in the absence of antigenic re-stimulation, may contribute to the increased rate and severity of infectious diseases in the elderly and may also explain why

latent viruses, such as varicella zoster (human herpesvirus 3), may reactivate many years after initial infection.

The memory population is not simply an expansion of corresponding naive cells

In general, memory cells are more readily stimulated by a given dose of antigen because they have a higher affinity. In the case of B-cells, we are satisfied by the evidence that links mutation and antigen-driven selection, occurring within the germinal centers of secondary lymph node follicles, to the creation of high-affinity memory cells. The receptors for antigen on memory T-cells also have higher affinity but, as they do not undergo significant somatic mutation during the priming response, it would seem that cells with *pre-existing receptors of relatively higher affinity in the population of naive cells proliferate selectively through preferential binding to the antigen.*

Intuitively one would not expect to improve on affinity to the same extent that somatic hypermutation can achieve for the B-cells, but nonetheless memory T-cells augment their binding avidity for the antigen-presenting cell through increased expression of accessory adhesion molecules, CD2, LFA-1, LFA-3, and ICAM-1. As several of these molecules also function to enhance signal transduction, the memory T-cell is more readily triggered than its naive counterpart. Indeed, memory cells enter cell division and secrete cytokines more rapidly than naive cells, and there is some evidence that they may secrete a broader range of cytokines than do naive cells.

A phenotypic change in the isoform of the leukocyte common antigen CD45R, derived by differential splicing, allows

some distinction to be made between naive and memory cells. Expression of CD45RA has been used as a marker of naive T-cells and of CD45RO as a marker of memory cells capable of responding to recall antigens. However, most of the features associated with the CD45RO subset are in fact manifestations of *activated cells* and CD45RO cells can revert to the CD45RA phenotype. Memory cells, perhaps in the absence of antigenic stimulation, may therefore lose their activated status and join a resting pool. Another marker used for differentiating naive from memory cells takes one step back on the CD ladder and utilizes differences in the relative expression of the adhesion molecule CD44; naive T-cells seem to express low levels of CD44 whereas memory T-cells express high levels.

A role for CD44 in antagonizing Fas-dependent signals for apoptosis

Evidence suggests that CD44 may be important for entry into the memory cell compartment through the inhibition of Fas-dependent signals for apoptosis (Figure 8.44). As we discussed above, Fas–FasL interactions play an important role in the elimination of a sizable proportion of recently activated lymphocytes. In addition to becoming susceptible to FasL-driven apoptosis, activated T-cells upregulate surface expression of CD44 and maintain high expression thereafter but the role of CD44 in T-cell function was somewhat unclear; however, recent observations implicate CD44 as having a role in dictating entry into the memory compartment. Influenza-specific CD44-deficient versus wild-type Th1 cells were adoptively transferred into wild-type mice and subsequent antigenic

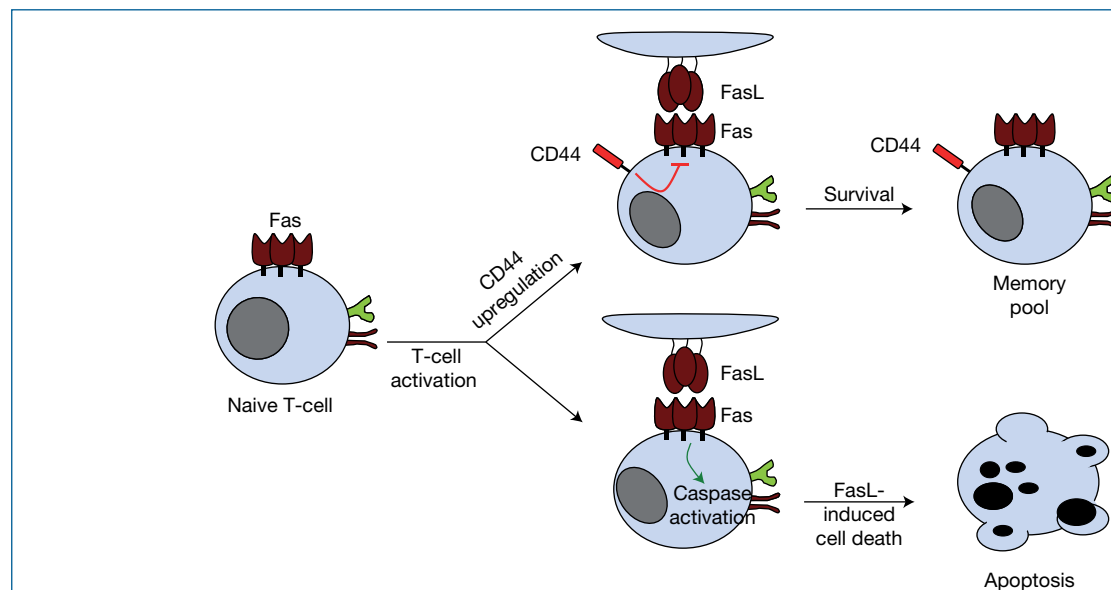


Figure 8.44 CD44 can antagonize Fas–Fas ligand-dependent apoptosis of expanded T-cells. T-cells become susceptible to apoptosis-triggering signals routed through surface Fas receptors within a few days after activation. The source of Fas ligand (FasL) can be from the activated T-cell itself (autocrine), a neighboring activated T-cell (paracrine), a cytotoxic T-cell, or a dendritic cell. Upregulation of surface CD44 appears to be able to interfere with Fas-dependent signals for apoptosis, via a mechanism that remains to be defined, and this may protect activated T-cells from deletion and permit entry into the memory compartment. Note that this mechanism may only apply to Th1 cells.

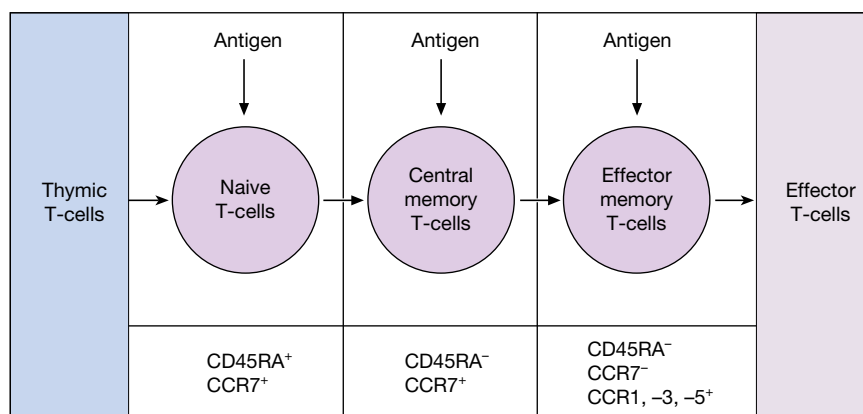


Figure 8.45 Central and effector memory T-cells. Naive T-cells bear the CD45RA splice variant of the CD45 molecule and are attracted from the thymus into secondary lymphoid tissue under the influence of CCR7-binding chemokines such as CCL19 (MIP-3 β) and CCL21 (6CKine/SLC). Upon encounter with antigen, some of these cells become effectors of the primary immune response, whereas others differentiate into central memory T-cells that retain the CCR7 chemokine receptor but lose expression of CD45RA. Subsequent re-encounter with antigen will push these cells into the effector memory compartment with replacement of CCR7 by other chemokine receptors such as CCR1, CCR3, and CCR5. This changes the homing characteristics of these cells that can now relocate as cytokine-secreting or cytotoxic T-cells to inflammatory sites under the influence of a number of chemokines including CCL3 (MIP-1 α), CCL4 (MIP-1 β), and CCL5 (RANTES) (see Table 8.2). Note that while the activation and subsequent differentiation of these cells is dependent on antigen, both central memory and effector memory T-cells are thought to be long-lived in the absence of antigen.

challenge found that whereas robust antigen recall responses could be found in the CD44-positive cells, CD44-deficient cells failed to respond to antigen. CD44 deficiency did not appear to impact on either T-cell activation, expansion in response to antigen, or acquisition of effector function. However, such cells were susceptible to Fas-dependent apoptosis during the later stages of expansion unlike their CD44-expressing counterparts, although the mechanisms for this effect remain unclear. A caveat is that CD44-mediated protection appears to apply only to Th1 cells and thus different mechanisms may operate in different T-cell subsets.

Antonio Lanzavecchia and colleagues have proposed that the CCR7 chemokine receptor allows a distinction to be made between CCR7⁺ “central memory” T-cells, which differentiate from naive T-cells, and CCR7⁻ “effector memory” T-cells, which subsequently arise from the central memory T-cells (Figure 8.45). Both populations are long-lived. The central memory cells provide a clonally expanded pool of antigen-primed cells that can travel to secondary lymphoid organs under the influence of the CCL21 (SLC) chemokine (see Table 8.2) and, following re-encounter with antigen, can stimulate dendritic cells, help B-cells and generate effector cells. In contrast, effector memory T-cells possess CCR1, CCR3, and CCR5 receptors for proinflammatory chemokines and constitute tissue-homing cells that mediate inflammatory reactions or cytotoxicity.

Maintenance of memory cells

Recently, IL-7 has emerged as a key regulator of peripheral T-cell survival and homeostatic turnover. Unlike most other cytokines that use receptors containing the common γ chain

(CD132), IL-7 is produced constitutively at low levels, is detectable in human serum, and may contribute to the antigen-independent maintenance of CD4 and CD8 memory T-cells by stimulating homeostatic division of these cells. Whereas studies using MHC-deficient mice have shown that peptide–MHC interactions are not essential for the persistence of memory T-cells, CD4 T-cells decline rapidly in the absence of IL-7. The expression of IL-7R is highest on resting cells, ensuring that these cells compete more effectively for available IL-7 than activated effector T-cells. Indeed, stimulation via the TCR induces downregulation of the receptor for IL-7 as effector T-cells come under the influence of cytokines produced during immune responses (such as IL-2, IL-4, IL-7, IL-15, and IL-21). As the response subsides, T-cells become dependent on IL-7 for their continued survival once more. Thus, the current view is that IL-7 contributes to the antigen-independent maintenance of T-cells by permitting homeostatic division of these cells in the absence of antigenic stimulation (Figure 8.46). IL-15 also appears to be more important for the maintenance of CD8 memory T-cells as mice deficient in either IL-15 or IL-15R α chain display reduced CD8 T-cell memory that can be rescued by transfer of these cells to normal mice. Thus, IL-7 and IL-15 appear to act in concert to maintain the memory T-cell pool, the latter being particularly important for the maintenance of CD8 memory T-cells (Figure 8.46).

The persistence of memory cells may also be influenced by physical factors, such as the length of *chromosomal telomeres*, which impose limits on the number of divisions that most mammalian cells can undergo; the so-called *Hayflick*

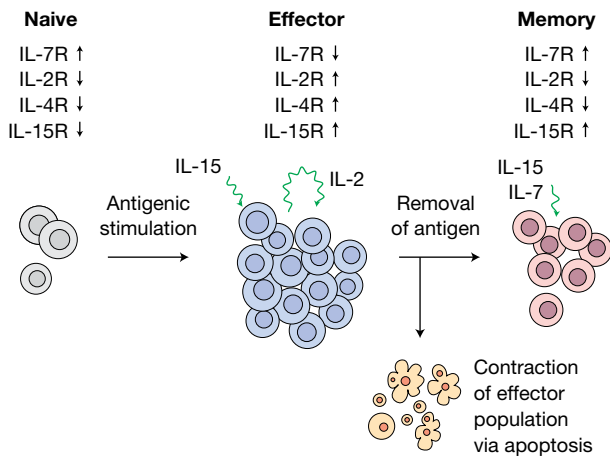


Figure 8.46 Cytokine receptor expression and cytokine availability control T-cell proliferation and survival. Naive CD4 and CD8 T-cells express high levels of IL-7R and low levels of receptors for other cytokines, such as IL-2, IL-4, and IL-15, which can influence T-cell proliferation and survival. Antigenic stimulation induces downregulation of IL-7R and upregulation of receptors for IL-2, IL-4, and IL-15 as these cytokines sustain T-cell clonal expansion and survival during the effector phase of the immune response. During resolution of the immune response, massive apoptosis occurs within the effector cell compartment leaving only the “fittest” cells to become memory cells. The memory cell compartment appears to rely upon IL-7 for long-term survival, with IL-15 also thought to be required, particularly for the maintenance of memory CD8 T-cells.

limit. The progressive erosion of chromosomal telomeres during each cell division can result in cells entering a state of senescence from which they cannot exit. In this situation, cells are unable to divide further and are likely to be functionally compromised and therefore of little further use to the immune system. For many cell types, the Hayflick limit is typically reached within 40–50 cell divisions, but lymphocytes may be permitted somewhat more cell divisions than this because of the upregulation of the telomere-lengthening enzyme *telomerase* within activated lymphocytes. It has been reported that CD8 T-cells fail to upregulate telomerase after four re-stimulations with antigen, whereas CD4 T-cells may retain this ability for longer.

Virgin B-cells lose their surface IgM and IgD and switch receptor isotype on becoming memory cells, and the differential expression of these surface markers has greatly facilitated the separation of B- and T-cells into naive and memory populations for further study. The co-stimulatory molecules B7.1 (CD80) and B7.2 (CD86) are rapidly upregulated on memory B-cells, and the potent ability of these cells to present antigen to T-cells could well account for the brisk and robust nature of secondary responses. A scheme similar to that outlined in Figure 8.45 for T-cells may also exist for the B-lymphocyte compartment, with an initial population of memory cells possessing the B220 marker developing into B220⁺ memory B-cells that then go on to generate antibody-secreting effector cells.

PAMPs and DAMPs sensed by innate immune cells shape adaptive immune responses

- Combinations of PAMPs and DAMPs detected by cells of the innate immune system are translated into distinct cytokine signatures.
- Cytokine patterns generated by APCs, especially DCs, play a critical role in tailoring the adaptive immune response towards the desired effector response.

Effector mechanisms

- The innate immune system utilizes a number of different effector mechanisms (such as phagocytosis, complement activation, and deployment of cells containing cytotoxic granules, such as NK cells and eosinophils) to combat infection.
- Similarly, adaptive immunity also employs a range of effector mechanisms, including the deployment of cytotoxic T-cells (T_c or CTL), T helper cells (Th) and antibody-secreting B-cells. Th cells can be further subdivided into Th1, Th2, Th17, and T_{fh} cells on the basis of the cytokine profiles that these cells produce and this confers different effector functions on such cells.
- Cytokines heavily influence the generation as well as the specific function of effectors within the adaptive immune system.

- Dendritic cells, with contributions from other cells of the innate immune system, play a central role in the generation of effectors through the provision of signal 3, which represents distinct patterns of cytokines that have polarizing influences on the effector cells subsequently generated.
- The nature of signal 3 is influenced by the combination of PAMPs and DAMPs that promote DC maturation and migration to lymph nodes.

Cytokines and chemokines orchestrate immune responses

- Chemokines are specialized chemotactic cytokines that promote cell migration towards the source of the chemokine.
- There are two distinct functional classes of chemokines: inflammatory and homeostatic.
- Inflammatory chemokines are inducibly expressed upon exposure of innate immune cells to PAMPs and DAMPs and promote rapid recruitment of immune cells, especially macrophages and neutrophils.
- Inflammatory chemokines are rapidly evolving (because of pathogen pressure) and highly divergent molecules that exist as two major gene clusters in humans. Members of this chemokine class can bind to more than one type of

chemokine receptor and can act as natural antagonists of certain receptors.

- Human and mouse inflammatory chemokines are not well conserved.
- Homeostatic chemokines are more evolutionarily ancient than their inflammatory counterparts and are more highly conserved. Members of this chemokine class are constitutively expressed and are involved in guiding cells of the immune system to lymphoid organs as well as other tissues.

Cytokines act as intercellular messengers

- Cytokines act transiently and usually at short range (in an autocrine or paracrine manner), although circulating IL-1 and IL-6 can mediate release of acute phase proteins from the liver.
- Cytokines are mostly small proteins that act through surface receptors belonging to six structural families.
- Cytokine-induced dimerization of individual subunits of the main (hematopoietin) receptor family activates protein tyrosine kinases, including JAKs, and leads to phosphorylation and activation of STAT transcription factors.
- Cytokine signaling can be downregulated by members of the SOCS and PIAS family of inhibitors that act to suppress JAK activity or STAT-dependent transcription, respectively.
- Cytokine signaling is also frequently routed through the NF κ B activation pathway. NF κ B is a transcriptional regulator of numerous proinflammatory genes.
- NF κ B activation is regulated through degradation of its specific inhibitor, I κ B, which is achieved through activation of the IKK complex, a kinase complex that can phosphorylate I κ B, thereby triggering degradation of the latter via the proteasome.
- Cytokine effects are regulated using several strategies, including: natural receptor antagonists, decoy (nonsignaling receptors), soluble receptors, as well as intracellular signal transduction pathway inhibitors.
- Cytokines are pleiotropic (i.e., have multiple effects) in the general areas of: (i) control of lymphocyte growth, (ii) activation of innate immune mechanisms (including inflammation), (iii) control of bone marrow hematopoiesis, and (iv) induction or suppression of cell death (apoptosis).
- Cytokines may act sequentially, through one cytokine inducing production of another or by transmodulation of the receptor for another cytokine; they can also act synergistically or antagonistically.
- Cytokines act in hierarchical cascades with certain cytokines acting more apically (i.e., upstream) than others.
- Some cytokines have broad effects (e.g., TNF, IL-1 family members), whereas the actions of others are more downstream and target-specific (e.g., IL-2).

- The roles of cytokines *in vivo* can be assessed by gene “knockout,” transfection, or inhibition by specific antibodies.

A succession of genes is upregulated by T-cell activation

- Within 15–30 minutes, genes for transcription factors concerned in the progression G0 to G1 and in the control of IL-2 are expressed.
- Up to 14 hours, cytokines and their receptors are expressed.
- Later, a variety of genes related to cell division and adhesion are upregulated.
- Activated T-cells differentiate to effector cells after 4–5 days of clonal expansion.

Activated T-cells proliferate in response to cytokines

- IL-2 acts as an autocrine growth factor for Th1 and paracrine for Th2 cells that have upregulated their IL-2 receptors.
- Cytokines act on cells that express the appropriate cytokine receptor.

Different T-cell subsets can make different cytokines

- The cytokine milieu that is established within the initial stages of infection, owing to distinct combinations of PAMPs and DAMPs, has a significant influence on the pattern of cytokines secreted by Th cell populations.
- As immunization proceeds, Th tend to develop into four subsets: Th1, Th2, Th17, and Tfh cells.
- Th1 cells promote macrophage activation and delayed type sensitivity and make IL-2 and -3, IFN γ , TNF, lymphotoxin, and GM-CSF; Th2 cells help B-cells to synthesize antibody and secrete IL-3, -4, -5, -6, and -13, TNF, and GM-CSF; Th17 cells mount massive inflammatory responses to fungi and extracellular bacteria, especially at mucosal surfaces. Th17 cells make IL-17A, IL-21, IL-22, and IL-17F and elicit the production of proinflammatory cytokines and chemokines by nonimmune cells, such as endothelial cells and fibroblasts, to promote neutrophil recruitment to the site of inflammation. Tfh cells are specialized for the provision of help to B-cells and home to B-cell follicles because of their constitutive expression of the homing receptor CXCR5. Tfh cells promote the development of germinal centres by providing CD40L stimulation to B-cells along with IL-4 and IL-21.
- Interaction of antigen with macrophages or dendritic cells, via their Toll-like receptors (TLRs) and other pattern recognition receptors, leads to production of IL-12 and IL-27 that skews T-cell responses to the Th1 type, or IL-4 that will skew the responses to the Th2 pole. IL-6 and IL-1 in combination with TGF β initially, followed by IL-23 later, is important for the production of Th17 cells. IL-6 and IL-21, as well as ICOSL are important in polarization towards Tfh cells.

CD4-positive T-cell effectors in cell-mediated immunity

- Cytokines mediate chronic inflammatory responses and induce the expression of MHC class II on endothelial cells, a variety of epithelial cells and many tumor cell lines, so facilitating interactions between T-cells and nonlymphoid cells.
- Differential expression of chemokine receptors permits selective recruitment of neutrophils, macrophages, dendritic cells, and T- and B-cells.
- TNF synergizes with $\text{IFN}\gamma$ in killing cells.
- T-cell-mediated inflammation is strongly downregulated by IL-4 and IL-10.

Regulatory T-cells (Tregs) police the actions of T helper cells

- Different classes of Tregs exist. Thymus-derived Tregs are thymus-generated Foxp3^+ CD4^+ T-cells that can dominantly antagonize the actions of self-reactive T-cells and prevent the development of autoimmunity as well as excessive immune responses towards pathogens.
- Peripherally induced T-reg cells can be produced through suboptimal TCR-mediated stimulation especially in the presence of IL-10 or $\text{TGF}\beta$.
- Tregs exert their effects through multiple mechanisms, including the secretion of immunosuppressive cytokines IL-10, $\text{TGF}\beta$, and IL-35, the killing of autoreactive T-cells and APCs through granzyme B/perforin, competition for IL-2, or CTLA-4-mediated effects. The predominant effector mechanism is likely to depend on the specific circumstances as well as the tissue.
- CTLA-4-mediated antagonism of efficient antigen presentation and co-stimulation of DCs by Tregs may be a core mechanism of action.
- Tregs may also be important contributors to tissue repair after injury through production of cytokines such as amphiregulin in response to DAMPs (such as IL-18 and IL-33) released from dead cells.

CD8⁺ T-cell effectors in cell-mediated immunity

- Cytotoxic T-cells are generated against cells (e.g., virally infected) that have intracellularly derived peptide associated with surface MHC class I. They kill using lytic granules containing perforin and granzymes or via the Fas–Fas ligand pathway.
- CTLs contain modified lysosomes equipped with a battery of cytotoxic proteins, collectively called cytotoxic granules. The cytotoxic granule-dependent pathway to apoptosis is orchestrated by granzyme B, a serine protease that can process and activate the mitochondrial-permeabilizing protein Bid, as well as members of the caspase family of cell death proteases. Granzyme A also plays an important role in granule-dependent killing.
- Fas-dependent killing is routed through caspase-8, which kills in a manner very similar to granzyme B by activating

downstream caspases that then coordinate death of the cell in the manner of apoptosis.

- Caspase activation coordinates target cell death from within. Upon activation, caspases cleave literally hundreds of cellular proteins to coordinate apoptosis.
- Apoptotic cells are rapidly cleared through phagocytosis as a result of the appearance of membrane changes (e.g., phosphatidylserine externalization) that enable phagocytes to selectively recognize and remove these cells.

Proliferation of B-cell responses is mediated by cytokines

- Early proliferation is mediated by IL-4 that also aids IgE synthesis.
- IgA producers are driven by $\text{TGF}\beta$ and IL-5.
- IL-4 plus IL-5 promote IgM and IL-4, -5, -6, and -13 plus $\text{IFN}\gamma$ stimulate IgG synthesis.

Events in the germinal center

- T follicular helper (Tfh) cells are essential for the formation and maintenance of germinal centers and these cells oversee the process of affinity maturation of antibodies through somatic hypermutation, selecting only the highest affinity B-cell clones through limited provision of help (CD40L, IL-21, IL-4) to B-cells.
- There is clonal expansion, isotype switch, and mutation in the dark zone centroblasts.
- Affinity matured B-cells return to the light zone of the germinal center where they compete with other B-cells to capture antigen complexes from follicular dendritic cells. Cells that capture and present the most antigen to Tfh cells receive the appropriate co-stimulation to promote their survival; those that don't, die.
- The B-cell centroblasts die through apoptosis unless rescued by certain signals that upregulate *bcl-2*. These include receiving co-stimulation and cytokines (IL-21, IL-4) from Tfh cells as well as engagement of the CD40 receptor that drives the cell to the memory compartment.
- The selection of mutants by antigen guides the development of high-affinity B-cells.

The synthesis of antibody

- RNA for variable and constant regions is spliced together before leaving the nucleus.
- Differential splicing allows coexpression of IgM and IgD with identical V regions on a single cell and the switch from membrane-bound to secreted IgM.

Ig class switching occurs in individual B-cells

- IgM produced early in the response switches to IgG, particularly with thymus-dependent antigens. The switch is largely under T-cell control.
- IgG, but not IgM, responses improve on secondary challenge.

Antibody affinity during the immune response

- Low doses of antigen tend to select high-affinity B-cells and hence antibodies as only these can be rescued in the germinal center.
- For the same reasons, affinity matures as antigen concentration falls during an immune response.

Memory cells

- Upon disappearance of the source of antigen that initiated their production, the vast majority of effector lymphocytes are eliminated via apoptosis. A fraction of antigen-responsive cells are retained, possibly those with the highest affinity for antigen, and these form the memory compartment.
- Apoptosis of activated effector lymphocytes occurs in large measure via the Fas–Fas ligand-dependent pathway. FasL may be supplied in an autocrine or paracrine manner.
- How memory cell lymphocytes are produced is still a somewhat mysterious process.
- Memory cell development may be a distinct differentiation trajectory that is taken by cells below a certain threshold of antigen-dependent stimulation. As antigen disappears from the system, memory cell generation may be naturally favored over the generation of effector cells.
- An alternative idea is that asymmetric division of activated lymphocytes may contribute to the generation of memory versus effector cells through the unequal distribution of cell fate determinants that influence their subsequent differentiation.
- Murine memory T-cells can be maintained in the absence of antigen but human T-cell memory may require periodic restimulation with antigen.
- Immune complexes on the surface of follicular dendritic cells in the germinal centers provide a long-term source of antigen.
- Memory cells have higher affinity than naive cells, in the case of B-cells through somatic mutation, and in the case of T-cells through selective proliferation of cells with higher affinity receptors and through upregulated expression of associated molecules such as CD2 and LFA-1, that increase the avidity (functional affinity) for the antigen-presenting cell.
- Activated memory and naive T-cells are distinguished by the expression of CD45 isoforms, the former having the CD45RO phenotype, the latter CD45RA. It seems likely that a proportion of the CD45RO population reverts to a CD45RA pool of resting memory cells. CD45RA⁻ memory cells can be divided into CCR7⁺ central memory and CCR7⁻ effector memory cells.
- High levels of CD44 expression are also characteristic of memory T-cells, low-level expression being associated with naive T-cells.
- CD44 may participate in the generation of memory through antagonizing Fas-dependent signals for apoptosis.
- IL-7 appears to be critical for the long-term survival of CD4 T-cell populations and is preferentially bound by resting T-cells. Memory CD8 T-cells require IL-15 for their long-term survival.



Now visit www.roitt.com to test yourself on this chapter.

FURTHER READING

- Abbas A.K., Benoist C., Bluestone J.A., *et al.* (2013) Regulatory T cells: recommendations to simplify the nomenclature. *Nature Immunology* **14**, 307–308.
- Arpaia N., Green J.A., Molteni B., *et al.* (2015) A distinct function of regulatory T cells in tissue protection. *Cell* **162**, 1078–1089.
- Arsenio J., Metz P.J., and Chang J.T. (2015) Asymmetric cell division in T lymphocyte fate diversification. *Trends in Immunology* **36**, 670–683.
- Barnes M.J. and Powrie F. (2009) Regulatory T cells reinforce intestinal homeostasis. *Immunity* **31**, 401–411.
- Beverly P.C.L. (2004) Kinetics and clonality of immunological memory in humans. *Seminars in Immunology* **16**, 315–321.
- Bradley L.M., Haynes L., and Swain S.L. (2005) IL-7: maintaining T-cell memory and achieving homeostasis. *Trends in Immunology* **26**, 172–176.
- Crotty S. (2014) T follicular helper cell differentiation, function, and roles in disease. *Immunity* **41**, 529–542.
- Crotty S. (2015) A brief history of T cell help to B cells. *Nature Reviews Immunology* **15**, 185–189.
- Cullen S.P. and Martin S.J. (2008) Mechanisms of granule-dependent killing. *Cell Death and Differentiation* **15**, 251–262.
- Delgoffe G.M., Murray P.J., and Vignali D.A. (2011) Interpreting mixed signals: the cell's cytokine conundrum. *Current Opinion in Immunology* **23**, 632–638.
- Hercus T.R., Thomas D., Guthridge M.A., *et al.* (2009) The granulocyte-macrophage colony-stimulating factor receptor: linking its structure to cell signaling and its role in disease. *Blood* **114**, 1289–1298.
- Iwasaki A. and Medzhitov R. (2015) Control of adaptive immunity by the innate immune system. *Nature Immunology* **16**, 343–353.

- Josefowicz S.Z., Lu L.F., and Rudensky A.Y. (2012) Regulatory T cells: mechanisms of differentiation and function. *Annual Reviews of Immunology* **30**, 531–564.
- Kapsenberg M.L. (2003) Dendritic cell control of pathogen-driven T-cell polarization. *Nature Reviews Immunology* **3**, 984–993.
- Korn T., Bettelli E., Oukka M., and Kuchroo V.K. (2009) IL-17 and Th17 cells. *Annual Review of Immunology* **27**, 485–517.
- Littman D.R. and Rudensky A.Y. (2010) Th17 and regulatory T cells in mediating and restraining inflammation. *Cell* **140**, 845–858.
- Mitchell D.M. and Williams M.A. (2010) An activation marker finds a function. *Immunity* **32**, 9–12.
- O'Garra A. and Murphy K.M. (2009) From IL-10 to IL-12: how pathogens and their products stimulate APCs to induce T_H1 development. *Nature Immunology* **10**, 929–932.
- Okabe Y. and Medzhitov R. (2015) Tissue biology perspective on macrophages. *Nature Immunology* **17**, 9–17.
- O'Shea J.J. and Paul W.E. (2010) Mechanisms underlying lineage commitment and plasticity of helper CD4⁺ T cells. *Science* **327**, 1098–1102.
- Restifo N.P. and Gattinoni L. (2013) Lineage relationship of effector and memory T cells. *Current Opinion in Immunology* **25**, 556–563.
- Sawant D.V. and Vignali D.A. (2014) Once a Treg, always a Treg? *Immunological Reviews* **259**, 173–191.
- Schenten D. and Medzhitov R. (2011) The control of adaptive immune responses by the innate immune system. *Advances in Immunology* **109**, 87–124.
- Schluns K.S. and Lefrançois L. (2003) Cytokine control of memory T-cell development and survival. *Nature Reviews Immunology* **3**, 269–279.
- Strasser A., Jost, P.J., and Nagata S. (2009) The many roles of FAS receptor signaling in the immune system. *Immunity* **30**, 180–192.
- Taylor R.C., Cullen S.P., and Martin S.J. (2008) Apoptosis: controlled demolition at the cellular level. *Nature Reviews Molecular Cell Biology* **9**, 231–241.
- Victoria G.D. and Nussenzweig M.C. (2012) Germinal centers. *Annual Reviews of Immunology* **30**, 429–457.
- Zlotnik A. and Yoshie O. (2012) The chemokine superfamily revisited. *Immunity* **36**, 705–716.

CHAPTER 9

The regulation of the immune response

Key topics

- Immunogenetics 273
- Antigenic competition 276
- Complement and antibody help regulate immune responses 276
- Activation-induced cell death 277
- CD28 superfamily members that negatively regulate the immune response 279
- Immunoregulation by T-cells 281
- Regulatory immunoneuroendocrine networks 285
- Dietary effects on immunity 287
- The influence of gender and aging 287

Just to recap ...

The broadly specific phagocytic and inflammatory cells of the innate response often have to migrate to the site of the infection. Furthermore, the lymphocytes of the adaptive response need to proliferate in organized secondary lymphoid tissues (the mucosa-associated lymphoid tissues, lymph nodes, and spleen) in order to generate sufficient numbers of antigen-specific cells. T-cells must be activated by professional antigen-presenting cells, with most B-cell responses requiring help from T-cells that have specificity for the same antigen. Multiple levels of regulation exist to ensure that these responses are both quantitatively and qualitatively appropriate.

Introduction

Upon contact with an infectious agent, the appropriate antigen-specific cells of the acquired immune response proliferate, often to form a sizable proportion of the lymphocytes in the local lymphoid tissues. However, it is crucial that this process does not become excessive as this could lead to the immune response itself causing substantial damage to our own tissues. Furthermore, it is important that responses only occur as a reaction to foreign pathogens and that once the pathogen has been eliminated the immune system returns to its resting state. It makes sense for **antigen** to be a major regulatory factor and for immune responses to be driven by the presence of an infection, falling off in intensity as the pathogen is eliminated (Figure 9.1).

Immunogenetics

It is absolutely clear that the genetic makeup of an individual influences the immune response. In the 1970s Guido Bizzio and colleagues showed that mice can be selectively bred for

high or low antibody responses through several generations to yield two lines, one of which consistently produces high-titer antibodies to a variety of antigens, and the other, antibodies of relatively low titer (Figure 9.2). A substantial number of genes are known to influence the immune response.

Antigen receptor genes recombine in lymphocytes

Clearly, the Ig and TCR *V*, *D*, and *J* genes encoding the specific recognition sites of the lymphocyte antigen receptors are of fundamental importance to the acquired immune response. However, since the recombination mechanisms for generating receptor diversity from the available genes are so powerful (see Chapter 4), immunodeficiency is unlikely to occur as a consequence of a poor Ig or TCR variable region gene repertoire. Nevertheless, just occasionally, we see “holes in the repertoire” due to the absence of a gene; for example the failure to respond to the sugar polymer α 1–6 dextran, which is a feature of animals without a particular immunoglobulin *V* gene, and mice lacking the *Va2* TCR gene which cannot mount a cytotoxic T-cell response to the male H-Y antigen.

Immune responses are influenced by the MHC

There was much excitement when it was first discovered that the antibody responses to a number of thymus-dependent antigenically simple substances are determined by genes mapping to the major histocompatibility complex (MHC). For example, mice of the *H-2^b* haplotype respond well to the synthetic branched polypeptide (T,G)-A–L, whereas *H-2^k* mice respond poorly (Table 9.1). With another synthetic antigen, (H,G)-A–L, having histidine in place of tyrosine, the position is reversed,

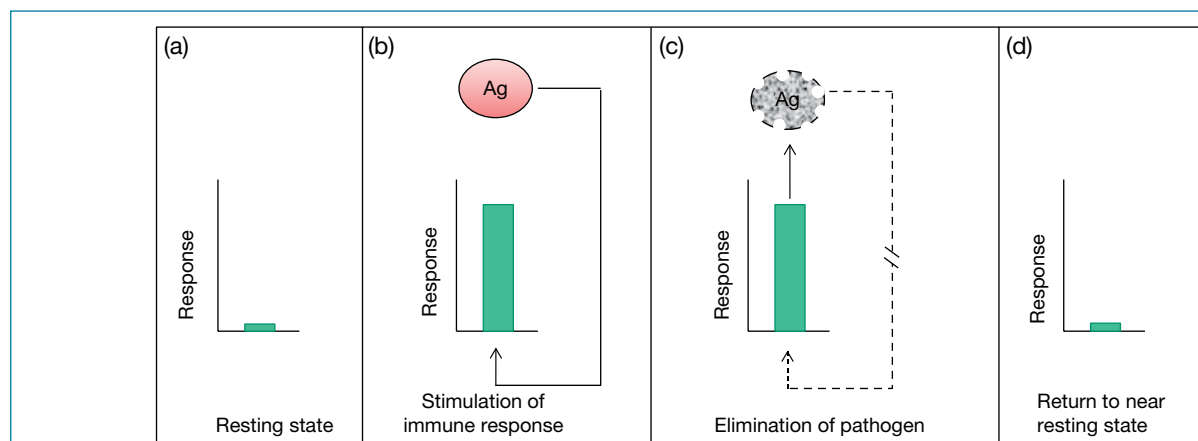


Figure 9.1 Antigen drives the immune response. The immune response is stimulated by antigen. A basal level of immune response is maintained by tissue resident cells of the innate response and by naive (and any preexisting memory) lymphocytes of the acquired response. Upon encounter with antigen an immune response is generated involving the proliferation and differentiation of antigen-specific lymphocytes in secondary lymphoid tissues and the recruitment of both innate and acquired cells to the site of the infection. Upon successful elimination of the pathogen the stimulus disappears and the immune response returns to its near resting state (but now with enhanced memory with respect to the acquired response).

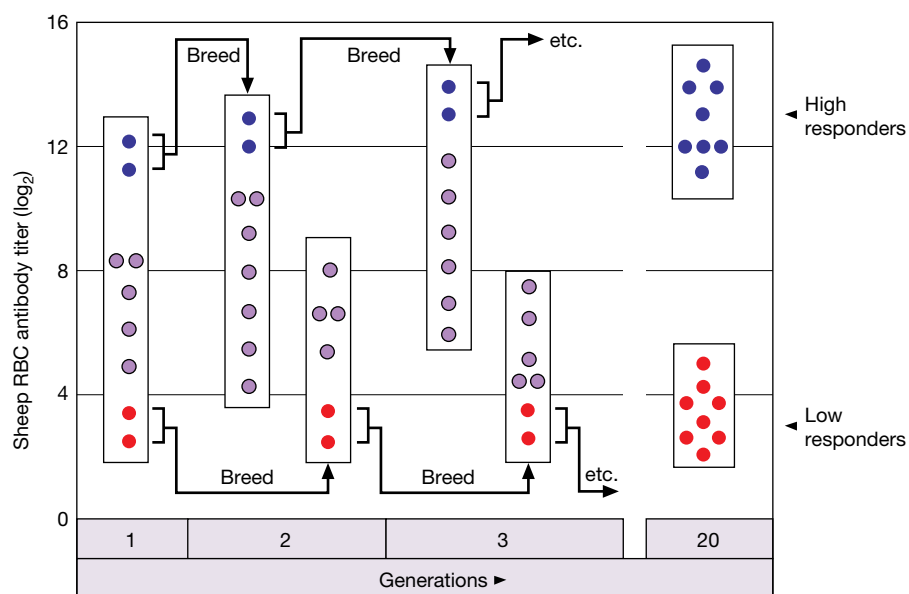


Figure 9.2 Selective breeding of high and low antibody responders. A foundation population of wild mice (with diverse genetic makeup and great variability in antibody response) is immunized with sheep red blood cells (RBC), a multideterminant antigen. The antibody titer of each individual mouse is shown by a circle. The male and female giving the highest titer antibodies (blue dots) were bred and their litter challenged with antigen. Again, the best responders were bred together and so on for 20 generations when all mice were high responders to sheep RBC and a variety of other antigens. The same was done for the poorest responders (red dots), yielding a strain of low responder animals.

Table 9.1 H-2 haplotype linked to high, low and intermediate immune responses to synthetic peptides.

Antigen	H-2 haplotype				
	b	k	d	a	s
(T,G)-A-L	Hi	Lo	Int	Lo	Lo
(H,G)-A-L	Lo	Hi	Int	Hi	Lo

(T,G)-A-L, polylysine with polyalanine side-chains randomly tipped with tyrosine and glutamine; (H,G)-A-L, the same with histidine in place of tyrosine.

the “poor (T,G)-A-L responders” now giving a good antibody response and the “good (T,G)-A-L responders” a weak one, showing that the capacity of a particular strain to give a high or low response varies with the individual antigen (Table 9.1). These relationships are only apparent when antigens of highly restricted structure are studied because the response to each single determinant is controlled by an MHC gene and it is less likely that the different determinants on a complex antigen will all be associated with consistently high or consistently low responder genes. However, although one would expect an average of randomly high and low responder genes, as the various determinants on most thymus-dependent complex antigens are structurally unrelated, the outcome will be biased by the dominance of one or more epitopes.

Table 9.2 Mapping of the MHC gene for (H,G)-A-L responses by analysis of different recombinant strains.

Strain	H-2 region				(H,G)-A-L response
	K	A	E	D	
A	k	k	k	b	Hi
A.TL	s	k	k	b	Hi
B.IO.A (4R)	k	k	b	b	Hi
B.IO	b	b	b	b	Lo
A.SW	s	s	s	s	Lo

With complex antigens, in most but not all cases, H-2 linkage is usually only seen when the dose administered is so low that just one immunodominant determinant is recognized by the immune system. In this way, reactions controlled by MHC genes are distinct from the overall responsiveness to a variety of complex antigens that is a feature of the Biozzi mice (mentioned earlier).

The MHC controls antigen presentation to $\alpha\beta$ T-cells

Table 9.2 gives some idea of the type of analysis originally used to map the MHC genes in mice. The three high responder strains have individual H-2 genes derived from prototypic pure

strains (B.10 and A.SW) that have been interbred to produce recombinations within the H-2 region. The only genes the high responders have in common are A^k and D^b ; as the B.10 strain bearing the D^b gene is a low responder, high response must be linked in this case to possession of A^k . The I region (I-A and I-E) molecules are the murine class II MHC molecules, and polymorphisms within these genes affect the peptide-binding groove and therefore their ability to present antigen to CD4⁺ helper T-cells. They thus directly influence the responsiveness of the mice with respect to their thymus-dependent antibody response to antigen *in vivo*. Indeed, there is a good correlation between antigen-specific T-cell proliferation and the antibody responder status of the animal. This also explains why these *H-2* gene effects are seen with thymus-dependent but not T-independent B-cell antigens.

Three mechanisms can account for class II-linked high and low responsiveness: antigen presentation, T-cell repertoire, and T-cell-mediated suppression.

1. Antigen presentation

In a high responder, processing of antigen and its recognition by a corresponding T-cell lead to lymphocyte triggering and clonal expansion (Figure 9.3a). Although there is (and has to be) considerable degeneracy in the specificity of the class II groove for peptide binding, as alluded to above the variation in certain key residues can alter the strength of binding to a particular peptide and convert a high to a low responder because the MHC fails to present antigen to the reactive T-cell (Figure 9.3b). Sometimes the natural processing of an antigen in a given individual does not produce a peptide that fits well into their MHC molecules. One study showed that a cytotoxic T-cell clone restricted to HLA-A2, which recognized residues 58–68 of influenza A virus matrix protein, could cross-react with cells from an HLA-A69 subject pulsed with the same peptide; nonetheless, the clone failed to recognize HLA-A69 cells infected with influenza A virus, probably because individuals with the HLA-A69 class I MHC develop immunity to a different epitope on the same protein.

2. T-cell repertoire

T-cells with moderate to high affinity for self-MHC molecules and their complexes with processed self-antigens are tolerized, so creating a “hole” in the T-cell repertoire. If there is a cross-reaction (i.e., similarity in shape at the T-cell recognition level between a foreign antigen and a self-molecule that has already induced unresponsiveness) the host will lack T-cells specific for the foreign antigen and therefore be a low responder (Figure 9.3c). To take a concrete example, mice of DBA/2 strain respond well to the synthetic peptide polyglutamyl, polytyrosine (GT), whereas BALB/c mice do not, although both have identical class II genes. Activated B-cells from BALB/c mice express a structure that mimics GT and the presumption would be that self-tolerance makes these mice unresponsive to GT. This was confirmed by showing that DBA/2 mice made tolerant by a small number of BALB/c hematopoietic cells were changed from high to low responder status. To round off the

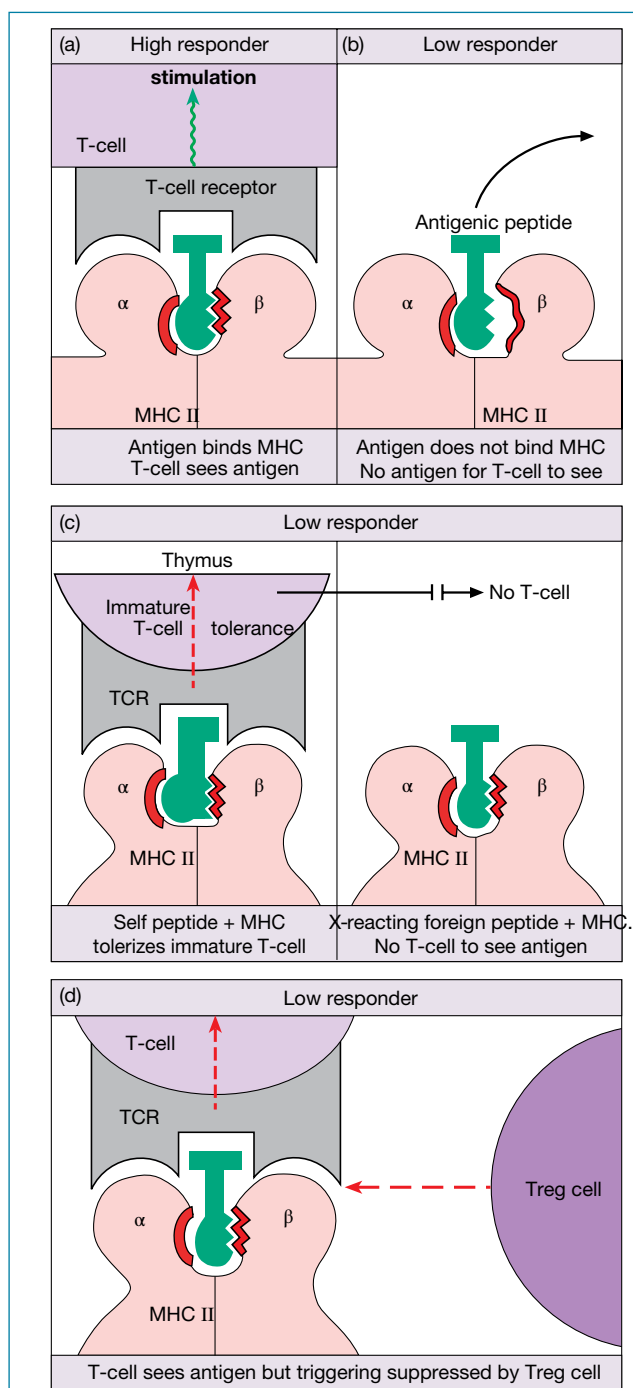


Figure 9.3 Different mechanisms can account for low T-cell response to antigen in association with MHC class II. (a) For the activation of CD4⁺ T-cells it is necessary for peptide to bind with a high affinity to the binding groove formed from the α_1 and β_1 domains of an MHC class II molecule and then for the TCR to bind to the peptide–MHC complex. (b) If the peptide is unable to bind to the MHC groove then clearly there is no possibility of a T-cell response. (c) During negative selection in the thymus T-cells will become tolerized to peptides derived from self antigens and this tolerance will extend to any similar (cross-reactive) peptides derived from foreign antigens. (d) Even if the peptide binds the MHC and the T-cell bears an appropriate TCR, under some circumstances responsiveness may be blocked by the presence of Tregs.

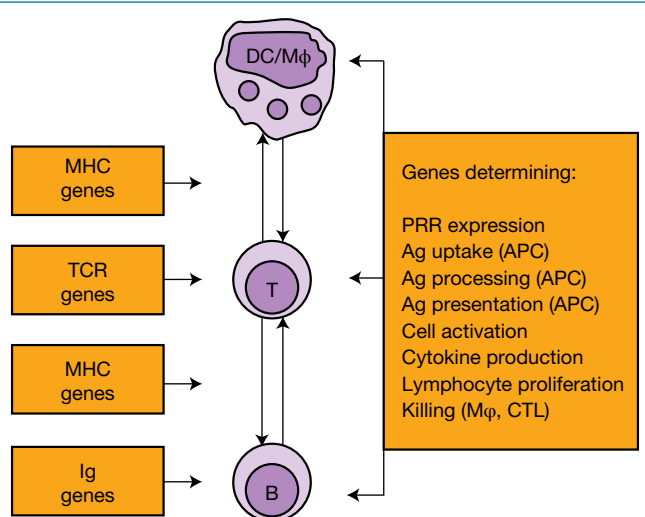


Figure 9.4 Genetic control of the immune response. Multiple genes determine immune responsiveness, including those that recombine to generate the antigen-specific receptors of lymphocytes, the highly polymorphic MHC genes, and genes determining a variety of activities of immune system cells. APC, professional antigen-presenting cells (dendritic cells [DC], macrophages [Mφ], B-cells); PRR, pattern recognition receptors.

story in a very satisfying way, DBA/2 mice injected with BALB/c B-blasts, induced by the polyclonal activator lipopolysaccharide, were found to be primed for GT.

3. T-cell-mediated suppression

We would like to refer again to the transferable suppression that can occur to relatively complex antigens, as it illustrates the notion that low responder status can arise as a result of regulatory cell activity (Figure 9.3d). Low response can be dominant in class II heterozygotes, indicating that suppression can act against Th restricted to any other class II molecule. In this it differs from models 1 and 2 above where high response is dominant in a heterozygote because the factors associated with the low responder gene (defective presentation or defective T-cell repertoire) cannot influence the activity of a high responder gene if also present.

The wide variety of genetic contributions to the immune response is summarized in Figure 9.4.

Antigenic competition

The presence of one antigen in a mixture of antigens can drastically diminish the immune response to the others. This is true even for epitopes within a given molecule; for example certain epitopes within the pre-S2 region of the hepatitis B surface antigen are highly immunogenic, whereas others only induce relatively weak immune responses. Clearly, the possibility that certain antigens in a mixture, or particular epitopes in a given antigen, may compromise a desired protective immune response

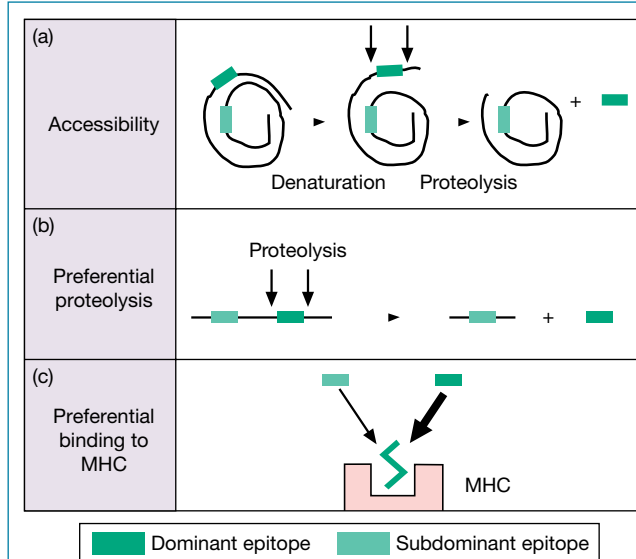


Figure 9.5 Mechanisms of epitope dominance at the MHC level. There is a clear hierarchy of epitopes with respect to competitive binding based on: (a) differential accessibility to proteases as the molecule unfolds; (b) the presence or absence of particular amino acid sequences that constitute protease sensitive sites; and (c) the relative affinity of the generated peptides for the MHC. Thus, dominant epitopes bag the lion's share of the available MHC grooves, whereas subdominant epitopes are less successful. The other factor that can influence dominance is the availability of reactive T-cells; if these have been eliminated (e.g., through tolerization by cross-reacting self-antigens) even a peptide that dominates the MHC groove would be unable to provoke an immune response.

has implications for vaccine design. Factors that determine immunodominance include the precursor frequency of the T- and B-cells bearing antigen receptors for different epitopes on the antigen, the relative affinity of the B-cell receptors for their respective epitopes, the degree to which the surface membrane antibody protects the epitope from proteolysis following endocytosis of the antibody–antigen complex by the B-cell, and the ability to generate processed antigenic peptides that have a strong affinity for the MHC groove (Figure 9.5).

Complement and antibody help regulate immune responses

Stimulatory activity

Innate immune mechanisms are usually first on the scene and activation of the alternative and/or lectin pathways of complement will lead to C3b and C3d deposition on the microbe. When C3d-coated antigens are recognized by the B-cell, cross-linking of the B-cell receptor (BCR) and the CD21 complement receptor, with its associated signal-transducing molecule CD19, enhances B-cell activation (Figure 9.6a). IgM and IgG3 (which is produced relatively early following class switching in many immune responses) can also enhance the antibody response in a complement-dependent manner, and therefore

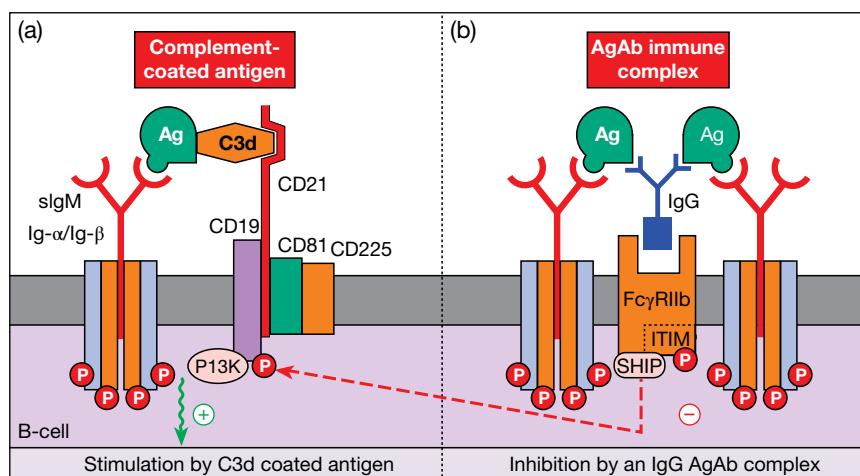


Figure 9.6 Cross-linking of surface IgM antigen receptor to the CD21 complement receptor stimulates and to the Fc γ receptor Fc γ RIIb inhibits B-cells. (a) Following activation of complement, C3d becomes covalently bound to the microbial surface. The CD21 complement receptor, which together with its associated CD19–CD81–CD225 (LEU13) signaling complex forms the B-cell co-receptor (see Figure 7.29), binds C3d. The complement-coated antigen cross-links this complex to the surface IgM (sIgM) of the BCR, leading to tyrosine phosphorylation of CD19 and subsequent binding of phosphatidylinositol 3-kinase (PI3K), which results in activation of the B-cell. (b) The Fc γ RIIb molecule possesses a cytoplasmic immunoreceptor tyrosine-based inhibitory motif (ITIM) and, upon cross-linking to membrane Ig, becomes phosphorylated and binds the inositol polyphosphate 5'-phosphatase SHIP. This suppresses phosphorylation of CD19 and thus inhibits B-cell activation.

presumably by the same mechanism but involving the classical pathway of complement activation. The other IgG subclasses can enhance not only antibody production but also CD4⁺ T-cell responses via binding of immune complexes to activating Fc γ R such as Fc γ RI, Fc γ RIIA, and Fc γ RIII and the resulting increased antigen uptake and presentation by dendritic cells. IgE antibodies can also stimulate production of all antibody isotypes and promote CD4⁺ T-cell responses. Here the mechanism is unclear but is known to be dependent upon B-cells that are expressing CD23 (Fc ϵ RII, the low-affinity receptor for IgE).

Inhibitory antibody responses

Paradoxically, IgG antibodies of all subclasses can not only stimulate but also inhibit the antibody response. One mechanism by which this is known to occur for most IgG subclasses is by cross-linking of the BCR to the Fc γ RIIb, which possesses an intracellular immunoreceptor tyrosine-based inhibitory motif (ITIM). This delivers a negative signal by suppressing tyrosine phosphorylation of CD19 (Figure 9.6b). Epitope masking by antibody can also inhibit B-cell responses by preventing the lymphocytes from seeing the relevant epitopes on the antigen. Indeed it would be logical if early on when the concentration and affinity of specific antibody is low there is stimulation of the response, but later when there is an excess of antibody the combination of epitope masking and negative feedback together with antigen elimination by phagocytosis and digestion downregulates the response. Multiple considerations, including antigen concentration, antibody affinity, epitope specificity, subclass distribution, and expression levels

of the relevant Fc γ R, probably determine whether IgG plays a stimulatory or inhibitory role during the course of an immune response.

Idiotypic networks

In 1974 the Nobel laureate Neils Jerne published a paper entitled “Towards a network theory of the immune system” in which he proposed that structures formed by the variable regions of antibodies (i.e., the antibody idiotype) could recognize other antibody variable regions in such a way that they would form a network based upon mutual idiotype–anti-idiotype interactions. Because B-cells use the antibody molecule as their antigen receptor this would provide a connectivity between different clones of B-cells. Perturbation of the network as a result of encounter with antigen would therefore have the potential for both upregulation and downregulation of the individual clones that are members of the network (Figure 9.7). There is no doubt that the elements that can form an idiotypic network are present in the body but the extent to which idiotypic interactions contribute to the regulation of immune responses is still debated among immunologists.

Activation-induced cell death

Clearly the removal of antigen from the body by the immune system will lead to a downregulation of lymphocyte proliferation owing to the absence of signals through the antigen receptor. However, even in the presence of antigen the potential for excessive proliferation is limited by a process referred

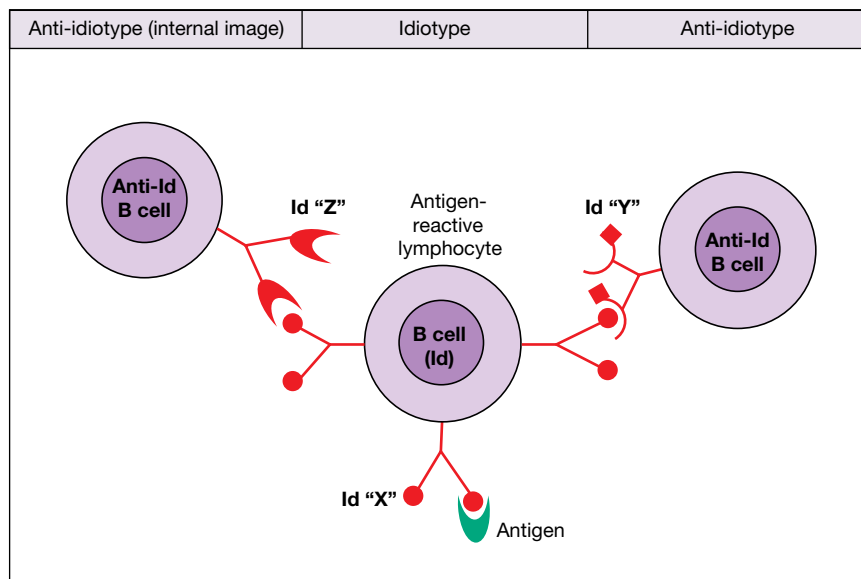


Figure 9.7 Antigen receptor variable regions connect lymphocytes via idiotypic interactions. Idiotypes (Id) are essentially “shapes” generated by the folding of amino acid sequences in the variable region of the antigen receptor. The receptors on one lymphocyte have the potential to reciprocally recognize an idiotype on the receptors of another lymphocyte if the two shapes “fit,” just like conventional antibody–antigen binding. Although these are mutual interactions between two different idiotypes, one of these idiotypes will usually be referred to as the anti-idiotype and the other as the idiotype. In practise they are both idiotypes and simultaneously both anti-idiotypes, an excellent example of the chicken and egg conundrum! Interaction through idiotype–idiotype recognition can potentially lead to stimulation or suppression of lymphocyte activity. B-cell–B-cell, B-cell–T-cell, and T-cell–T-cell interactions are all possible. For example, T-cell–T-cell interactions can occur through direct recognition of one T-cell receptor (TCR) by the other, or more usually by recognition of a processed TCR peptide associated with MHC. Out of the many different possible “anti-idiotype” structures some may by chance bear an idiotype of similar shape to the antigen (i.e., provide an internal image, represented by one of our own molecules, of a structure found in the external world – for example an antigen on a pathogen). This situation is illustrated by idiotype “Z” on the left of the figure that not only recognizes the antigen-specific idiotype “X” but also bears a structure similar to that of the antigen that is recognized by Id “X.” Idiotype “Y” on the right of the figure also recognizes idiotype “X” but does not bear any resemblance to the antigen. Note that receptors of different antigen specificity can sometimes bear the same idiotype (these are referred to as cross-reactive idiotypes) and that the network can be much more extensive than illustrated in the figure with anti-anti-Id, anti-anti-anti-Id, and so on.

to as activation-induced cell death (AICD). Subsequent to their activation, T-cells upregulate death receptors and their ligands (Figure 9.8a). The death receptors are members of the tumor necrosis factor receptor (TNFR) family and include TNFR1, Fas (CD95), TNF-related apoptosis-inducing ligand receptor 1 (TRAIL-R1, death receptor DR4), and TRAIL-R2 (DR5). If their ligands are present on cell surfaces then apoptosis is activated. The ligands are often also released from the cell surface by proteases, producing soluble forms that in some cases retain activity; for example the soluble version of TRAIL retains the ability to signal through TRAIL-R1. Such soluble ligands can potentially mediate either paracrine or autocrine cell death *in vivo*, and show promise as tumor therapeutics. Apoptosis induction through death receptors initially involves cleavage of the inactive cysteine protease procaspase-8 to yield active caspase-8 (Figure 9.8a). Ultimately, this activation pathway converges with the mitochondrial apoptosis pathway induced by cellular stress (Figure 9.8b), both leading to the activation of downstream effector caspases.

Although the death receptor and mitochondrial pathways are activated by different stimuli, they are interconnected in that caspase-8 can cleave the Bcl-2 family member Bid to produce a truncated form (tBid), which then activates Bax leading to mitochondrial outer membrane permeabilization. This allows pro-apoptotic molecules such as cytochrome *c* to be released from the space between the outer and inner mitochondrial membranes. Other members of the Bcl-2 family, such as Bcl-2 itself and Bcl-x_L, act as watchdogs to inhibit unwanted apoptosis by preventing the stimulation of outer membrane permeabilization.

Of particular relevance to death receptor-mediated AICD is the molecule FLIP, which exists in various forms. The long form of FLIP (FLIP_L) bears structural similarity to caspase-8, and therefore when expressed at high levels competitively inhibits recruitment of caspase-8 into the death-inducing signaling complex (DISC). Thus, FLIP levels can determine the fate of the cell when the death receptor is engaged by its ligand but does not affect apoptosis induced by the stress-activated mitochondrial pathway (Figure 9.9).

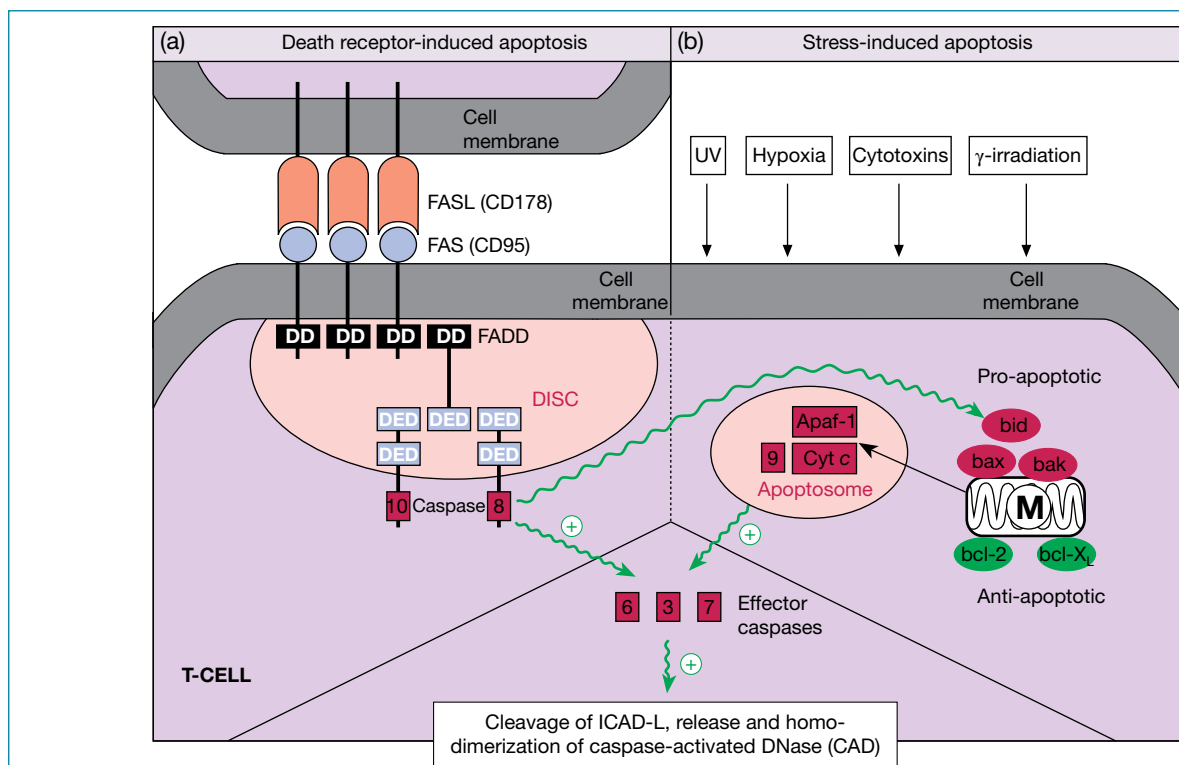


Figure 9.8 Activation-induced cell death involving death receptors and their ligands. (a) Receptor-based induction of apoptosis involves the trimerization of TNFR family members (e.g., Fas) by trimerized ligands (e.g., Fas-ligand [FasL]). This brings together cytoplasmic death domains (DD) that can recruit a number of death effector domain (DED)-containing adaptor molecules to form the death-inducing signaling complex (DISC). The different receptors use different combinations of DED-containing adaptors; Fas uses FADD (Fas-associated protein with death domain). The DISC, which also includes caspase-10, induces the cleavage of inactive procaspase-8 into active caspase-8 with subsequent activation of downstream effector caspases. This process eventually leads to the caspase-3-mediated cleavage of the long version of the inhibitor of caspase-activated DNase (ICAD-L). Cleavage of ICAD-L results in the release of CAD, which then homodimerizes to form the active endonuclease that cleaves internucleosomal DNA. (b) A second pathway of apoptosis induction, often triggered by cellular stress, involves a number of mitochondrion (M)-associated proteins including cytochrome *c* and pro-apoptotic (Bax, Bak, Bid) and anti-apoptotic (Bcl-2, Bcl-X_L) members of the Bcl-2 family. Caspase-9 activation is the key event in this pathway and requires the formation of the “apoptosome” complex formed when cytochrome *c* is released upon Bax- and Bak-mediated permeabilization of the mitochondrial outer membrane in response to pro-apoptotic signals. Following its association with cytochrome *c* and the co-factor Apaf-1, the procaspase-9 is activated and cleaves procaspase-3. M, mitochondrion (see Figure 8.31 and Figure 8.32).

CD28 superfamily members that negatively regulate the immune response

Programmed death-1 (PD-1), cytotoxic T lymphocyte antigen 4 (CTLA-4) and B- and T-lymphocyte attenuator (BTLA) belong to the same family of molecules as CD28 and ICOS, but unlike these two molecules they are involved in the negative regulation of immune responses rather than co-stimulation (Figure 9.10). Following cellular activation, PD-1 and BTLA are expressed on T-cells, B-cells, and myeloid cells, whereas CTLA-4 is present in significant amounts only on activated T-cells. Unlike CTLA-4, which shares its CD80 and CD86 ligands with CD28, there are specific ligands for PD-1; namely PD-L1 which is widely expressed by many cell types and

PD-L2 which, like CD80 and CD86, is present mainly on dendritic cells, macrophages, and B-cells. The ligand for BTLA is HVEM (Herpesvirus entry mediator) which is again present on professional antigen-presenting cells. All three of these negative regulators function by recruiting the SHP-1, SHP-2, and PP2A phosphatases which dephosphorylate a variety of signaling molecules required for cellular activation. The result is decreased cytokine production, reduced proliferation and differentiation, and a decline in cell survival. Because of their role in the negative regulation of immune responses, PD-1, CTLA-4, and BTLA play an important role in restraining excessive immune responses and preventing the development of autoimmune disease.

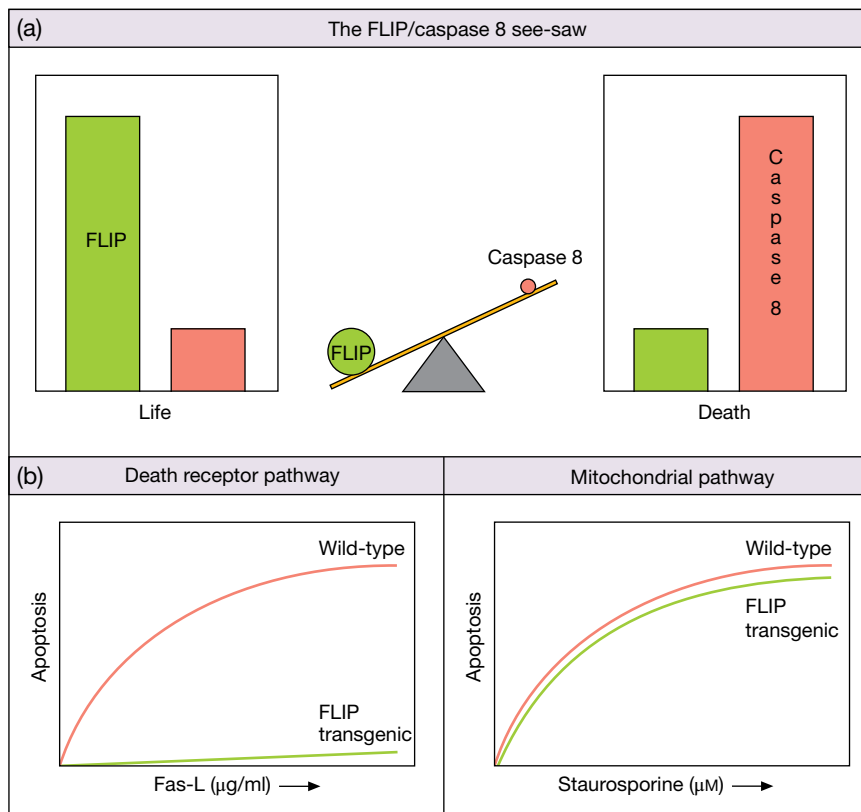


Figure 9.9 Life and death decisions. (a) The relative amounts of anti-apoptotic FLIP and pro-apoptotic caspase-8 can determine the fate of the cell. (b) Experiments involving overexpression of FLIP in transgenic mice indicate that this protein protects T-cells from activation-induced cell death (AICD) stimulated through the death receptor pathway by Fas-ligand, but not from cell death triggered via the mitochondrial pathway using the drug staurosporine. (Data source: J. Tschopp and colleagues.)

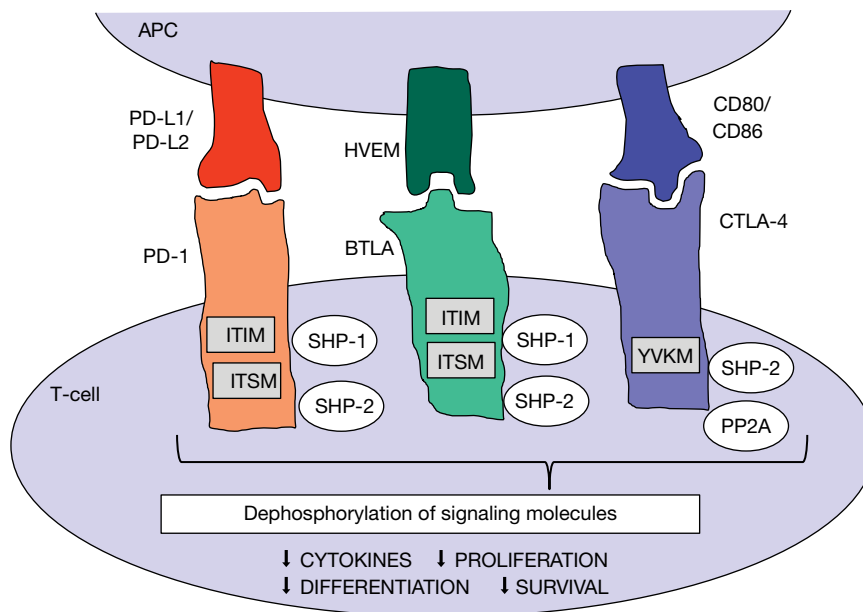


Figure 9.10 Inhibitory receptors of the CD28 superfamily. The cytoplasmic domains of PD-1 and BTLA, but not of CTLA-4, contain an immunoreceptor tyrosine-based inhibitory motif (ITIM) and an immunoreceptor tyrosine-based switch motif (ITSM), the latter responsible for recruiting the SHP-2 phosphatase. SHP-1 is also recruited although whether or not this is ITSM dependent is still an area of active research. CTLA-4 possesses an intracellular YVKM (tyrosine–valine–lysine–methionine) motif which recruits both the SHP-2 and PP2A phosphatases. SHP-1, SHP-2, and PP2A dephosphorylate several signaling molecules involved in T-cell activation, including phosphatidylinositol 3-kinase, Ras, Akt. and phospholipase $C\gamma$.

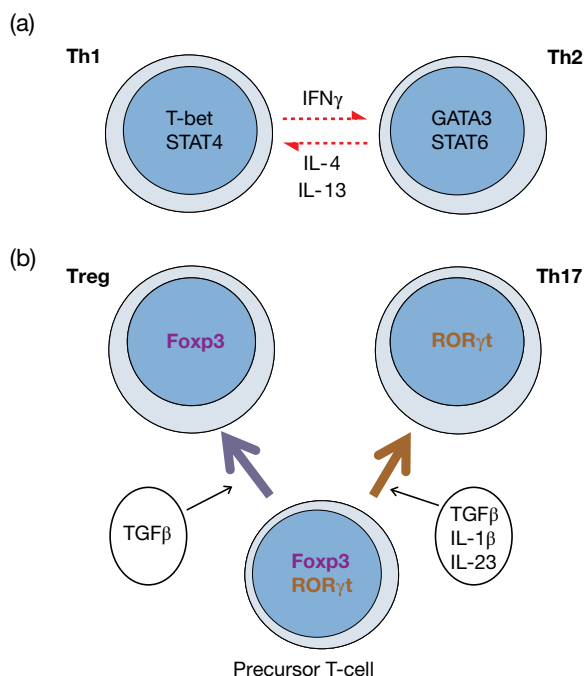


Figure 9.11 Antagonism between T-cell subpopulations. (a) Th1 cells are generated under the direction of IL-12 production by dendritic cells. Once they are generated they can suppress the generation of Th2 cells by secreting the cytokine $\text{IFN}\gamma$, which prevents the expression of the GATA3 and STAT6 transcription factors required for the Th2 phenotype, whereas the production of IL-4 and IL-13 by Th2 cells limits the expression of the T-bet and STAT4 transcription factors associated with Th1 activity. (b) The Foxp3 transcription factor acts antagonistically against the $\text{ROR}\gamma\text{t}$ transcription factor required for Th17 activity. Thus either Foxp3⁺ regulatory T-cells (Treg) or $\text{ROR}\gamma\text{t}$ ⁺ Th17 cells will tend to dominate, depending on which of these two transcription factors becomes most strongly expressed. This is, at least to some extent, controlled by the local cytokine environment.

Immunoregulation by T-cells

Helper T-cell specialization

Helper T-cells (Th) can be divided into different subsets, with different functional activities, based upon the cytokines they produce. The three major subpopulations that have so far been defined are $\text{IFN}\gamma$ -secreting Th1 cells, IL-4-secreting Th2 cells and IL-17-secreting Th17 cells. Don't worry that you have missed something because, although there are also cells referred to as Th3 cells as well as IL-9-producing Th9 cells, there aren't (as yet!) any Th cells with other numbers until you get to Th17. Note, however, that although Th1 and Th2 cells are "helper" cells they can also be viewed as "suppressor" cells with respect to the fact that they mutually antagonize each other's activity (Figure 9.11a). Indeed, it is a recurrent theme in immunology that individual cells and molecules can enhance some responses while inhibiting others in order to maintain immune homeo-

stasis. It should also be noted that there is considerable plasticity between the different CD4⁺ T-cell populations and they are therefore not necessarily "fixed" into one population for their entire life.

The Th17 subset share with the Foxp3⁺ regulatory T-cells (Tregs, shortly to be discussed) the fact that they are induced by the cytokine $\text{TGF}\beta$. However, Th17 cells are only induced when certain other cytokines are present (in the human IL-1 β and/or IL-23, in the mouse IL-6 and/or IL-21) and therefore precursor T-cells will differentiate into *either* Tregs (in the presence of $\text{TGF}\beta$ but absence of these particular cytokines) *or* Th17 cells, leading at least in part to a reciprocal relationship between these two populations (Figure 9.11b). Specialization is reinforced by the ability of the transcription factor Foxp3 in Tregs to bind to, and thereby inhibit, the $\text{ROR}\gamma\text{t}$ transcription factor required for Th17 cell activity. Unlike the suppressive Treg cells, Th17 cells are mostly concerned with promoting tissue inflammation.

T-cell-mediated suppression

In the early 1970s it was shown that, if mice were made unresponsive by injection of a high dose of sheep red blood cells (RBC), their T-cells would suppress specific antibody formation in normal recipients to which the T-cells had been transferred (Figure 9.12). It may not be apparent to the reader why this result was at all surprising, but at that time antigen-induced tolerance was regarded essentially as a negative phenomenon involving the depletion or silencing of clones rather than a state of active suppression. Over the years, T-cell-mediated suppression has been shown to modulate a variety of humoral and cellular responses, the latter including delayed-type hypersensitivity, cytotoxic T-cells, and antigen-specific T-cell proliferation. However, the existence of dedicated professional T-suppressor cells was a question that generated a great deal of controversy.

Originally, suppressor T-cells in mice were found to possess Ly2 (now called CD8 α) and Ly3 (CD8 β) on their surface. As researchers began to characterize these CD8⁺ T-suppressor cells they were described as expressing a molecule called I-J encoded within the MHC region and were able to produce soluble suppressor factors that were frequently antigen specific. These suppressor factors proved impossible to define biochemically, and when the entire murine MHC was cloned it was found that I-J didn't exist! There then, perhaps not unsurprisingly under the circumstances, followed a period of extreme skepticism regarding the very existence of suppressor T-cells. However, during the last few years they have made a dramatic comeback, although it is now appreciated that the majority of these cells belong to the CD4 rather than the CD8 T-cell lineage, and the current vogue is to refer to them as **regulatory T-cells (Tregs)**. The characterization of these cells has itself, however, not been without its problems and there seem to be several different types of Tregs. Although some require cell-cell contact in order to suppress, others depend upon soluble cytokines to mediate their effect.

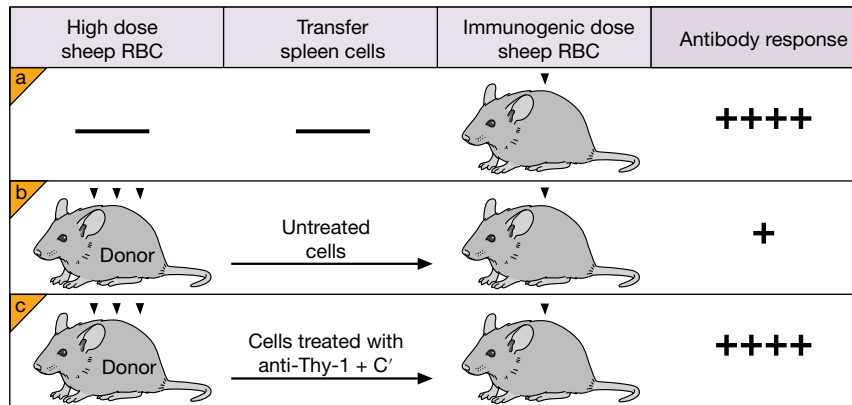


Figure 9.12 Demonstration of T-suppressor cells. (a) A mouse of an appropriate strain immunized with an immunogenic dose of sheep erythrocytes makes a strong antibody response. However, if spleen cells from a donor of the same strain previously injected with a high dose of antigen (b) are first transferred to the syngeneic animal, they depress the antibody response to a normally immunogenic dose of the antigen. The effect is lost (c) if the spleen cells are first treated with a T-cell-specific antiserum (anti-Thy-1) plus complement (C'), showing that the suppressors are T-cells. (Source: Gershon R.K. and Kondo K. (1971) *Immunology* 21, 903–914. Reproduced with permission of Wiley.)

Both CD4⁺ and CD8⁺ T-cells can suppress immune responses

Let us first look at CD8⁺ T suppressors. One experimental example relates to the B10.A (2R) mouse strain, which has a low immune response to lactate dehydrogenase β (LDH β) associated with the possession of the *H-2E β* gene of the k rather than b haplotype. Lymphoid cells taken from these animals after immunization with LDH β proliferate poorly *in vitro* in the presence of antigen, but if CD8⁺ cells are depleted, the remaining CD4⁺ cells give a much higher response. Adding back the CD8⁺ cells reimposes the active suppression. Human suppressor T-cells can also belong to the CD8 subset. Thus, for example, CD8⁺CD28⁻ suppressor cells can prevent antigen-presenting B-cells from upregulating co-stimulatory B7 molecules, thereby leading to an inability of these B-cells to elicit T-cell help for antibody production.

Although it is clear from such experiments that CD8⁺ T-cells can mediate suppression, the current view is that CD4⁺CD25⁺Foxp3⁺ Treg cells are the major effectors of suppression and are able to suppress the activity of CD4⁺ T-cells, CD8⁺ T-cells, dendritic cells, and B-cells. If anti-CD25 and complement are used to deplete CD25⁺ cells from the lymph nodes or spleen of BALB/c mice and then the remaining CD25⁻ cells transferred into athymic (nude) BALB/c mice, the recipients develop multiple autoimmune diseases. However, if CD4⁺CD25⁺ cells are subsequently given shortly after the CD25⁻ cells the mice do not develop autoimmune disease, suggesting that the CD4⁺CD25⁺ population contains Tregs that inhibit autoreactive T-cells. Many similar experiments have established that CD4⁺CD25⁺ T-cells do indeed include Tregs able to mediate suppression of autoimmunity, allograft rejection, and allergic responses. Because CD25 (the α chain of

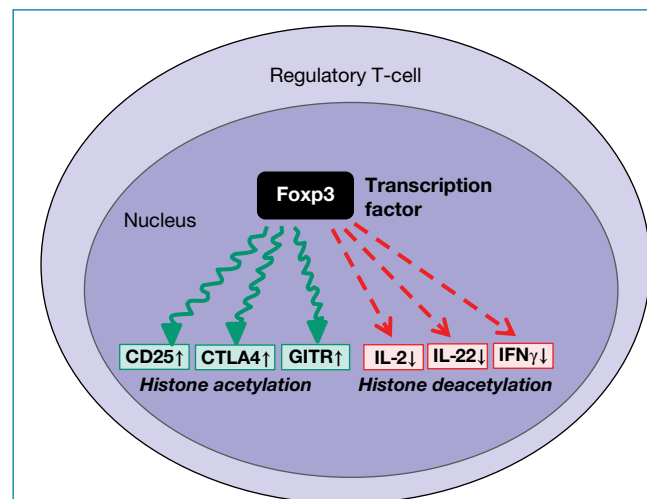


Figure 9.13 Role of the Foxp3 transcription factor in mediating suppression. Foxp3 present in the nucleus of regulatory T-cells binds to the promoter regions of the CD25, CTLA-4, and GITR (glucocorticoid-induced TNFR family-related) genes and recruits histone acetyltransferase enzymes, thereby causing acetylation of histones in that area of the DNA and thus facilitating activation of gene transcription. However, when Foxp3 binds to promoters associated with the IL-2, IL-22, and IFN γ genes it recruits histone deacetylase enzymes with resulting repression of gene transcription.

the IL-2 receptor) is a general marker of cell activation, it is not possible to use this as a defining characteristic of regulatory T-cells. Rather it is their expression of Foxp3 that most closely defines them as regulatory T-cells. Foxp3 is a forkhead transcription factor that controls the expression of a number of genes involved in determining the suppressive phenotype (Figure 9.13). Indeed, if the *Foxp3* gene is introduced into

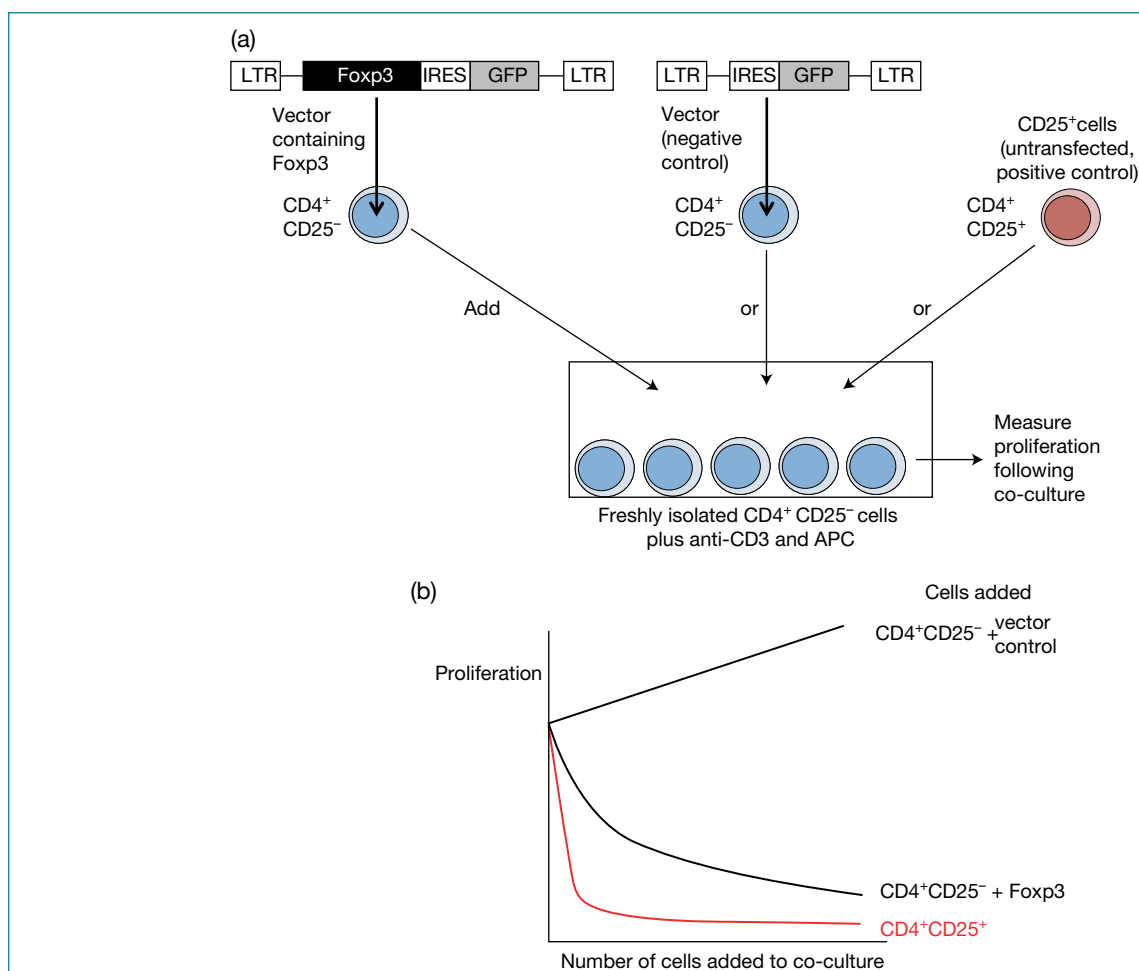


Figure 9.14 Acquisition of Fxop3 confers regulatory activity upon T-cells. (a) The *Fxop3* gene was introduced into a retroviral vector composed of 5' and 3' long terminal repeats (LTR), an internal ribosome entry site (IRES), and green fluorescent protein (GFP). This construct, or the vector without Fxop3, was then transfected into CD4⁺CD25⁻ cells (which are known to lack regulatory T-cell activity). Varying numbers (up to 2.5×10^4) of the transfected T-cells, or of nontransfected freshly isolated CD4⁺CD25⁺ Treg cells (as a positive control, red), were added to a culture of 2.5×10^4 freshly isolated CD4⁺CD25⁻ cells stimulated with an anti-CD3 mAb in the presence of antigen-presenting cells. (b) Proliferation (as measured by ³H-labeled TdR incorporation) was inhibited by Fxop3-transfected CD25⁻ T-cells to an extent comparable with that observed with the freshly isolated CD4⁺CD25⁺ Treg cells, indicating that Fxop3 confers suppressive activity on T-cells. (Adapted from Hori S., Nomura T., and Sakaguchi S. (2003) *Science* **299**, 1057–1061.)

naive CD4⁺CD25⁻ T-cells they are converted into cells capable of suppressing T-cell proliferation (Figure 9.14). Such transfected cells with newly acquired Fxop3 are, just like freshly isolated Tregs, able to protect mice against the development of autoimmune disease in various animal models.

Tregs can occur naturally or be induced by antigen

CD4⁺CD25⁺ Tregs comprise two major populations, *naturally occurring Tregs (nTregs)*, which express Fxop3 from the time they are produced in the thymus, and *inducible Tregs (iTregs)*, which arise in the periphery from CD4⁺CD25⁻Fxop3⁻ precursors and express Fxop3 and CD25 upon activation (Figure 9.15).

The naturally occurring Tregs also express CTLA-4, OX40, GITR (glucocorticoid-induced TNF receptor family-related molecule), L-selectin, and cell surface TGFβ. The activation of these cells is usually antigen specific, but they can subsequently suppress the responses to other antigens, a situation referred to as linked suppression. The precise mechanism they use to suppress immune responses to either the initiating antigen or to other antigens is still being established, but usually requires cell–cell contact between the regulator and the regulated. Proposed mechanisms include perforin/granzyme-mediated apoptosis of the regulated T-cell and CTLA-4-mediated interference with the activation of dendritic cells. Some induced Tregs have a very similar phenotype and are also thought to suppress via cell contact-dependent mechanisms.

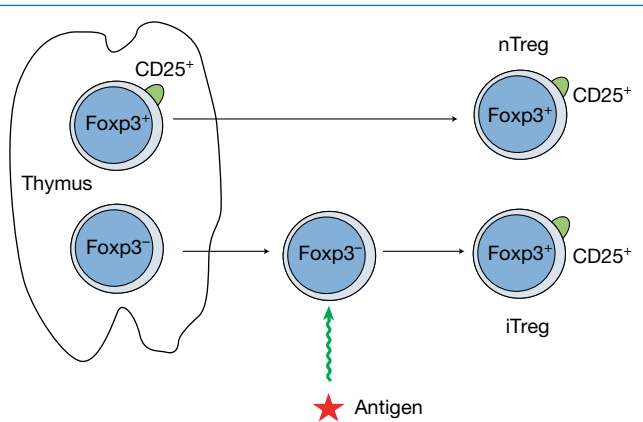


Figure 9.15 Naturally occurring and inducible regulatory T-cells. Naturally occurring regulatory T-cells (nTregs) already express Foxp3 and CD25 upon becoming mature in the thymus and can immediately act to suppress immune responses upon their entry into the periphery. In contrast, the inducible regulatory T-cells (iTregs) initially lack expression of Foxp3 and CD25, and the ability to suppress immune responses. However, they can convert into functional Foxp3⁺CD25⁺ Tregs following alterations in gene expression resulting from their stimulation by antigen in the secondary lymphoid tissues.

Different types of suppressor/regulatory cells

Regulatory T-cells that do not require cell–cell contact have also been described. Thus, human CD4⁺ cells stimulated with antigen in the presence of IL-10 can develop into CD25⁺CTLA-4⁺GITR⁺Foxp3⁺ Tr1 cells that themselves secrete IL-10, a cytokine that can mediate immunosuppressive functions (Figure 9.16). A further population of iTregs with a similar phenotype to Tr1 cells are the Th3 cells, which are defined by the fact that they secrete TGFβ, another cytokine with the capacity to be immunosuppressive. It should be noted that the various different subsets of CD4⁺ T-cells (Tregs, Th1, Th2, Th17, etc.) may not be locked into remaining as that cell type for their entire life, and that therefore a cell belonging to one subset may be able to convert into a different subset under certain microenvironmental conditions.

Various types of immunoregulatory γδ T-cells have also been described but they remain relatively poorly characterized. However, the ability of these cells to produce IL-10 and TGFβ certainly suggests that they have the potential to inhibit immune responses. Some γδ T-cells are Foxp3⁺ and, despite secreting substantial amounts of TGFβ they suppress T-cell proliferation by a cell contact-dependent mechanism. Another type of potentially regulatory cell is the NKT cell that bears an

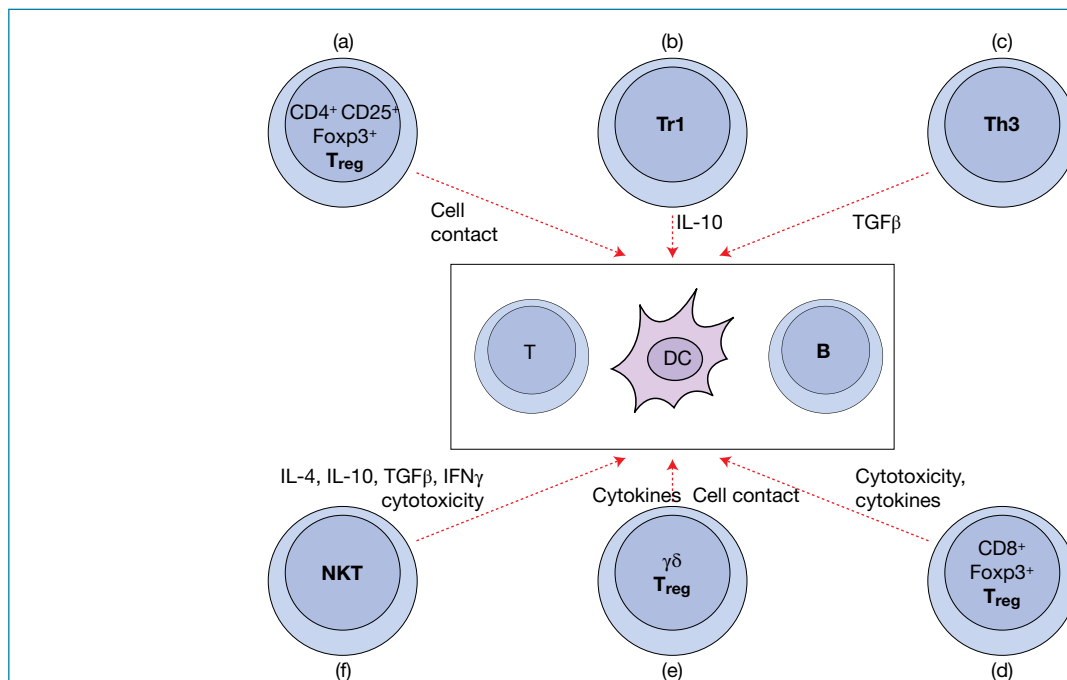


Figure 9.16 The diversity of regulatory/suppressor T-cells. A number of different types of regulatory/suppressor T-cells have been described that can act, to varying extents, to inhibit effector T-cells, B-cells, and dendritic cells. These include: (a) the naturally occurring and induced Tregs that generally suppress using mechanisms that require cell–cell contact; (b) IL-10-secreting Tr1 cells; (c) TGFβ-secreting Th3 cells; (d) CD8 cells that may suppress using cytotoxicity or cytokines; (e) immunosuppressive T-cells bearing a γδ TCR; and (f) NKT cells for which cytokine- and cytotoxicity-mediated modes of operation have been proposed.

invariant TCR, responds to self and foreign ceramide-based glycolipids (glycosphingolipids) and glycerol-based lipids (for example membrane phospholipids) presented by CD1d, and depending on the stimulatory context is able to develop into subsets that produce Th1 cytokines such as interferon- γ (IFN γ), Th2 cytokines including IL-4, or Th17 cytokines such as IL-17, IL-21, and IL-22.

It is not only T-cells that can act as suppressors. Regulatory B-cells exist that dampen immune responses by virtue of the fact that they secrete IL-10. Several studies have also recently shown that populations of granulocytic and monocytic cells that are able to inhibit T-cell activation are present in pathological situations, particularly in tumors. These **myeloid-derived suppressor cells** (MDSCs) seem to be able to limit T-cell responses by a variety of mechanisms, including depletion of L-arginine, leading to the arrest of cell proliferation. Their role, if any, in the normal physiological regulation of immune responses is somewhat unclear at present.

Ongoing research will hopefully help clarify the roles of the various types of suppressor/regulatory cells.

Some of the main factors controlling the immune response that have been discussed so far are summarized in Figure 9.17.

Regulatory immunoneuroendocrine networks

There is a danger, as one focuses more and more on the antics of the immune system, of looking at the body as a collection of myeloid and lymphoid cells roaming around in a big sack and of having no regard to the integrated physiology of the organism. Within the wider physiological context, attention has been drawn increasingly to interactions between immunological and neuroendocrine systems.

Immunological cells have the receptors that enable them to receive signals from a whole range of hormones: corticosteroids, insulin, growth hormone, estradiol, testosterone, prolactin, β -adrenergic agents, acetylcholine, endorphins, and enkephalins. By and large, glucocorticoids and androgens depress immune responses, whereas estrogens, growth hormone, thyroxine, and insulin do the opposite.

A neuroendocrine feedback loop affecting immune responses

The secretion of **glucocorticoids** is a major response to stresses induced by a wide range of stimuli, such as extreme changes of temperature, fear, hunger, and physical injury. They are also

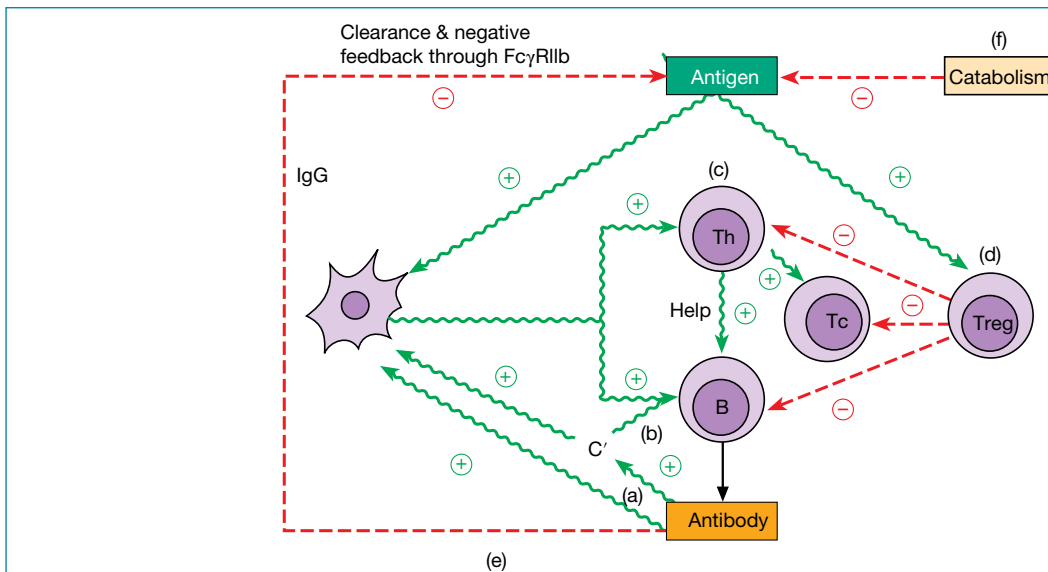


Figure 9.17 Regulation of the immune response. (a) Antibodies are able to stimulate immune responses by coating antigen for enhanced uptake by MHC class II $^+$ professional antigen-presenting cells and subsequent processing and presentation to helper T-cells, by forming Ab–Ag complexes that bind to Fc receptors on follicular dendritic cells for presentation of intact antigen to B-cells, and by activating complement via the classical pathway and thereby generating both C3b, which acts as an opsonin, and C3d (b), which is involved in B-cell co-stimulation. Helper T-cells (c) will provide assistance for the activation of B-cells and cytotoxic T-cells. Under some circumstances antigen will preferentially stimulate regulatory/suppressor T-cells (d), which will downregulate T- and B-cell responses. In addition to activating the response, antibodies are also able to downregulate immune responses (e) by facilitating the clearance of antigen from the body, by epitope masking, and, for IgG antibodies, by negative feedback through the Fc γ RIIb on B-cells. The catabolism (f) of the antigen by both the successful immune response and by the normal degradative processes of the body will clearly also lead to a loss of stimulation of the immune system.

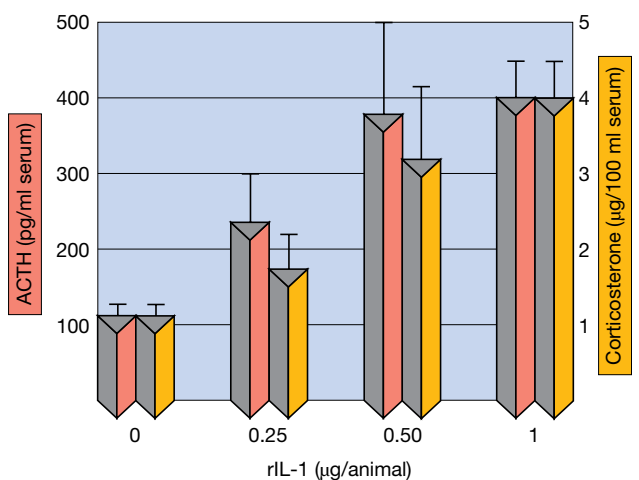


Figure 9.18 Enhancement of ACTH and corticosterone blood levels in C3H/HeJ mice 2 hours after injection of recombinant IL-1. Values are means \pm standard error of the mean (SEM) for groups of seven or eight mice. The significance of the mouse strain used is that it lacks receptors for bacterial lipopolysaccharide (LPS), and so the effects cannot be attributed to LPS contamination of the IL-1 preparation. (Source: Besedovsky H. *et al.* (1986) *Science* **233**, 652–654. Reproduced with permission of the AAAS.)

released as a consequence of immune responses and limit those responses in a neuroendocrine feedback loop. Thus, IL-1 β (Figure 9.18), IL-6, and TNF are capable of stimulating glucocorticoid synthesis and do so through the hypothalamic–pituitary–adrenal axis. This, in turn, leads to the downregulation of Th1 and macrophage activity, so completing the negative feedback circuit (Figure 9.19). Although glucocorticoids also inhibit Th2 cells, the mechanisms by which they inhibit Th1 and Th2 cells are different, and their inhibition of Th1 cells is much more potent. They strongly repress the T-bet transcription factor that is necessary for differentiation into the Th1 phenotype, but less vehemently inhibit the GATA3 transcription factor required for differentiation into Th2 cells. The immunosuppressive effects of glucocorticoids are reinforced by the induction of regulatory T-cells. Thus, incubating dendritic cells with the glucocorticoid dexamethasone results in expression of GILZ (glucocorticoid-induced leucine zipper), which causes the DCs to promote expression of Foxp3 in inducible Tregs.

“Psychoimmunology”

Both primary and secondary lymphoid tissues are richly innervated by the sympathetic nervous system. The enzyme dopamine β -hydroxylase catalyzes the conversion of dopamine to the catecholamine neurotransmitter norepinephrine, which is released from sympathetic neurons in these tissues. Mice in which the gene for this enzyme has been deleted by homologous recombination exhibited enhanced susceptibility to infection with *Mycobacterium tuberculosis* and impaired production of the Th1 cytokines IFN γ and TNF in response to

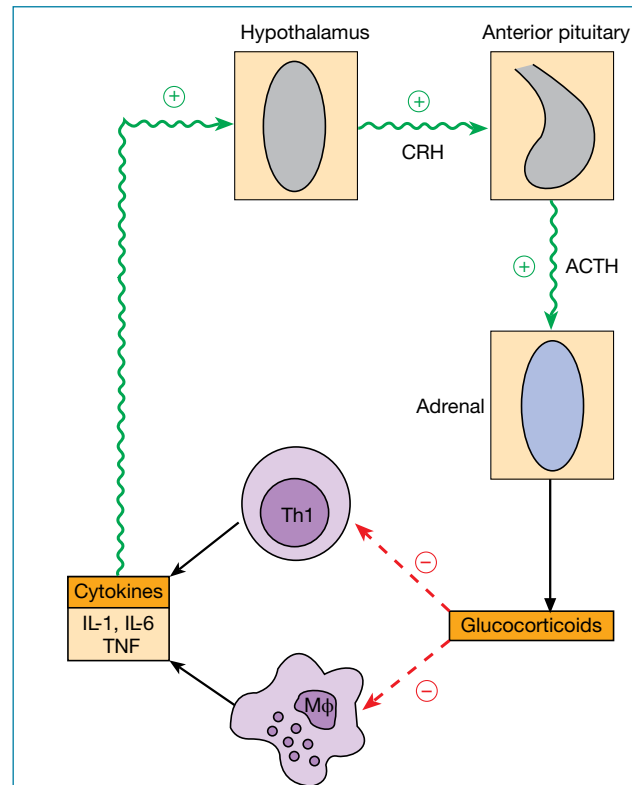


Figure 9.19 Glucocorticoid negative feedback on cytokine production. Additional regulatory circuits based on neuroendocrine interactions with the immune system are almost certain to exist given that lymphoid and myeloid cells in both primary and secondary lymphoid organs can produce hormones and neuropeptides, and classical endocrine glands as well as neurons and glial cells can synthesize cytokines and appropriate receptors. Production of prolactin and its receptors by peripheral lymphoid cells and thymocytes is worthy of attention. Lymphocyte expression of the prolactin receptor is upregulated following activation and, in autoimmune disease, witness the beneficial effects of bromocriptine, an inhibitor of prolactin synthesis, in the NZB \times NZW model of murine systemic lupus erythematosus. ACTH, adrenocorticotropic hormone; CRH, corticotropin-releasing hormone.

this intracellular pathogen. Although these animals showed no obvious developmental defects in their immune system, impaired Th1 responses were also found following immunization of these mice with the hapten TNP coupled to KLH. These observations suggest that norepinephrine can play a role in determining the potency of the immune response.

Denervated skin shows greatly reduced leukocyte infiltration in response to local damage, implicating cutaneous neurons in the recruitment of leukocytes. Sympathetic nerves that innervate lymphatic vessels and lymph nodes are involved in regulating the flow of lymph and may participate in controlling the migration of β -adrenergic receptor-bearing dendritic cells from inflammatory sites to the local lymph nodes. Mast cells and nerves often have an intimate anatomical relationship and nerve growth factor causes mast cell degranulation. The

gastrointestinal tract also has extensive innervation and a high number of immune effector cells. In this context, the ability of substance P to stimulate, and of somatostatin to inhibit, proliferation of Peyer's patch lymphocytes may prove to have more than a trivial significance.

There seems to be an interaction between inflammation and nerve growth in regions of wound healing and repair. Mast cells are often abundant, IL-6 induces neurite growth, and IL-1 enhances production of nerve growth factor in sciatic nerve explants. IL-1 also increases slow-wave sleep when introduced into the lateral ventricle of the brain, and both IL-1 and interferon produce pyrogenic effects through their action on the temperature-controlling center.

Although it is not clear just how these diverse neuroendocrine effects fit into the regulation of immune responses, at a more physiological level, stress and circadian rhythms modify the functioning of the immune system. Factors such as restraint, noise, and exam anxiety have been observed to influence a number of immune functions including phagocytosis, lymphocyte proliferation, NK activity, and IgA secretion. An elegant demonstration of nervous system control is provided by studies showing suppression of immune responses by Pavlovian conditioning. In the classic Pavlovian paradigm, a stimulus such as food that unconditionally elicits a particular response, in this case salivation, is repeatedly paired with a neutral stimulus that does not elicit the same response. Eventually, the neutral stimulus becomes a conditional stimulus and will elicit salivation in the absence of food. Rats were given cyclophosphamide (an immunosuppressive drug) as an unconditional and saccharin as a conditional stimulus repeatedly; subsequently, there was a depressed antibody response when the animals were challenged with antigen together with just the conditional stimulus, saccharin. As more and more data accumulate, it is becoming clearer how immunoneuroendocrine networks could play a role in allergy and in autoimmune diseases such as rheumatoid arthritis, type 1 diabetes, and multiple sclerosis.

Dietary effects on immunity

Malnutrition diminishes the effectiveness of the immune response

The greatly increased susceptibility of undernourished individuals to infection can be attributed to many other factors: poor sanitation and personal hygiene, overcrowding, and inadequate health education. But, in addition, there are gross effects of **protein-calorie malnutrition** on immunocompetence. The widespread atrophy of lymphoid tissues and a substantial reduction in circulating CD4 T-cells underlie serious impairment of cell-mediated immunity. Antibody responses may be intact but they are of lower affinity; phagocytosis of bacteria is relatively normal but the subsequent intracellular destruction is compromised. Deficiencies in vitamins B6 (pyridoxine), B9 (folic acid), C, and E result in generally impaired immune responses.

Zinc deficiency is rather interesting, reducing the activity of the thymus and thymic hormones, shifting the Th1/Th2 balance towards Th2-dominated responses, decreasing the effectiveness of vaccination, and leading to a decline in the activity of phagocytic cells and NK cells. Meanwhile, iron deficiency impairs the oxidative burst in neutrophils and macrophages as the flavocytochrome NADP oxidase is an iron-containing enzyme.

Of course there is another side to all this in that moderate restriction of total calorie intake and/or marked reduction in fat intake ameliorates autoimmune disease, at least in animal models. Omega-3 polyunsaturated fatty acids (PUFAs), as found in fish oils, have been shown to be protective in some but not all clinical trials involving patients with rheumatoid arthritis. This fact is perhaps not too surprising given the now well-established observation that PUFAs are able to downregulate the production of a number of proinflammatory cytokines, including TNF.

Vitamins A and D exhibit immunomodulatory effects

Retinoic acid, a **vitamin A** metabolite, stimulates the development of regulatory T-cells and Th2 cells, but inhibits the production of Th17 cells. Among the cells that produce retinoic acid are dendritic cells in the gut, leading to imprinting of T-cells with the CCR9 chemokine receptor and the $\alpha_4\beta_7$ integrin, the ligand for the mucosal addressin MAdCAM-1. This situation ensures that the appropriate lymphocytes home to the gut-associated lymphoid tissues. **Vitamin D** is also an important regulator. It is produced not only by the UV-irradiated dermis following exposure to sunlight, but also by activated macrophages. The hypercalcemia associated with sarcoidosis is attributable to production of the vitamin by macrophages in the active granulomas. The vitamin is a potent inhibitor of T-cell proliferation and of Th1 cytokine production. This generates a neat feedback loop at sites of inflammation where macrophages activated by IFN γ produce vitamin D, which suppresses the T-cells making the interferon. Vitamin D also downregulates antigen presentation by macrophages and promotes multinucleated giant cell formation in chronic granulomatous lesions. Just like vitamin A, vitamin D promotes Th2 activity, especially at mucosal surfaces, stimulates Treg activity and downregulates differentiation of Th17 cells: quite a busy little vitamin.

The influence of gender and aging

Females often mount somewhat stronger immune responses than males and are far more susceptible to autoimmune disease, an issue that will be discussed in greater depth in Chapter 17. It is noteworthy that both estrogen receptors and androgen receptors are present on various cell types in the immune system, including lymphocytes and macrophages. Although investigations into the role of estrogen in immune responses have frequently led to apparently contradictory data, it has

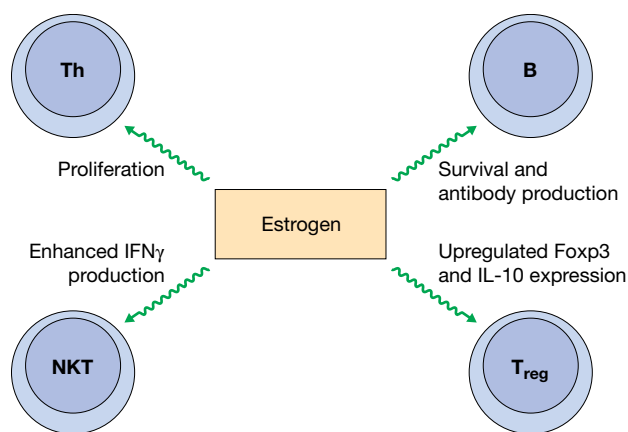


Figure 9.20 Some effects of estrogen on lymphocyte function.

often been found to stimulate helper T-cell, B-cell, and NKT cell responses but has also been shown to enhance the activity of regulatory T-cells (Figure 9.20). Likewise, androgen deprivation induced by castration of postpubertal male mice increases the levels of T-cells in secondary lymphoid tissues and enhances T-cell proliferation.

The pituitary hormone prolactin also has immunostimulatory activity for a variety of cells of the immune system including T-cells, B-cells, NK cells, macrophages, and dendritic cells. It has been shown to enhance antibody responses by both decreasing B-cell clonal deletion and by lowering the threshold for breaking anergy in B-cells, and increased levels of this hormone have been described in a number of systemic autoimmune diseases.

Immunosenescence

The elderly are more susceptible to infection and have decreased responses to vaccines compared with younger people. Spurred by improved longevity, attention is increasingly focused on understanding how our immune system wears out with age. There is now clear evidence that both the adaptive and innate arms of the immune response decline (Figure 9.21).

The thymic involution that occurs at puberty leads to a decreased output of T-cells and a reduction in thymic hormone production. As aging progresses there is a decline in the absolute numbers of both T-cells and B-cells but an increase in the absolute number of NK cells. Terminally differentiated T-cells accumulate in response to latent infection with cytomegalovirus and other pathogens, “crowding out” the ability to make adequate responses to newly encountered pathogens. Although both CD4⁺ and CD8⁺ T-cell populations decline, perhaps the most profound changes occur in the CD8 compartment. After repeated division CD8⁺ cells lose expression of the CD28 molecule required for co-stimulation. A lifetime of making immune

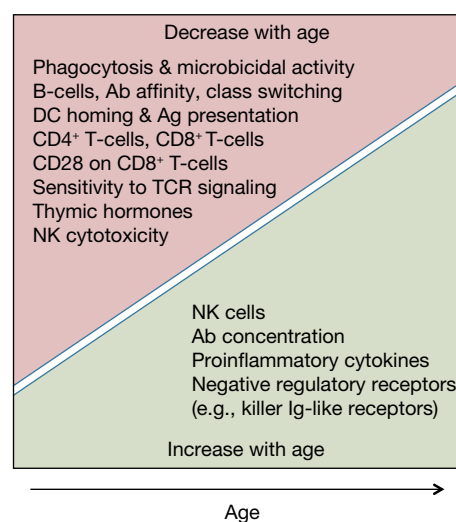


Figure 9.21 Age trends in some immunological parameters.

responses, coupled with the aforementioned reduced thymic output, lead eventually to T-cell clonal exhaustion. This exhaustion is a consequence of the fact that lymphocyte responses rely upon clonal proliferation. There is a finite number of times a cell can divide, the Hayflick limit, and this is associated with a shortening of the length of the telomeres at the ends of the chromosomes. Once this limit is reached the cells reach senescence and can no longer divide. Senescent lymphocytes, which possess a memory phenotype, may take up niches that could otherwise be occupied by T-cells proliferating in response to infection.

With regard to B-cells, there is a decline in cell number and, at least in mice, a decrease in the ability of both peripheral blood and splenic B-cells to class switch. There are reduced levels of the enzyme activation-induced cytidine deaminase (AID) in B-lymphocytes isolated from older mice; this enzyme is required for both class switching and affinity maturation. Rather paradoxically, not only IgM levels but also IgG and IgA antibody levels are increased in the aged. However, at least some of these antibodies are of relatively low affinity. The increase in total IgG and IgA antibody levels may reflect secretion by bone marrow plasmablasts of antibodies with limited somatic hypermutation.

Regarding innate responses, the phagocytic activity of both neutrophils and macrophages decreases, as does their microbicidal activity. Dendritic cells in mice appear to have both a reduced ability to home to lymph nodes and ability to stimulate T-cells. Not everything declines with age. Proinflammatory cytokines, including IL-1, IL-6, and TNF, are increased, and as already mentioned so are NK cell numbers. However, the proliferative response of these NK cells to IL-2 and their killing ability are impaired because of an increase in the expression of inhibitory receptors.

Immunogenetics

- Multiple genes control the immune response.
- Immunoglobulin and TCR genes rearrange to create an enormous diversity of antigen-specific receptors, but “holes” in the repertoire can occur.
- The MHC is highly polymorphic and encodes molecules which bind peptides for subsequent presentation to the T-cell receptor.

Antigenic stimulation and competition

- Immune responses are largely antigen driven. As the level of antigen falls due to an effective immune response, so does the intensity of the response.
- Antigens and epitopes within antigens can compete with each other. Some epitopes may be immunodominant.
- For T-cells, epitope competition occurs for the available MHC grooves.

Complement and antibody help regulate immune responses

- Antigens coated with C3d can boost antibody responses by cross-linking the CD21 complement receptor with the BCR.
- IgM, IgG, and IgE antibodies are able to boost antibody responses, either by activating complement via the classical pathway (IgM, IgG) or by facilitating FcR-mediated uptake of antigen by APCs.
- IgG is also able to limit antibody responses via a negative feedback mechanism through the inhibitory FcγRIIb on B-cells and also by Fc-independent effects that involve epitope masking so that the antigen is no longer able to be seen by the BCR on the B-cell.
- Antigen-specific receptors on lymphocytes can interact with the idiotypes on the receptors of other lymphocytes to form a network (Jerne) that may naturally regulate immune responses.

Activation-induced cell death

- Activated T-cells express members of the TNF receptor family, including Fas, which act as death receptors.
- Stimulation of these receptors restrains unlimited clonal expansion by promoting activation-induced cell death (AICD).

CD28 superfamily members that negatively regulate the immune response

- The CD28 superfamily contains both co-stimulatory molecules (CD28, ICOS) and inhibitory (PD-1, CTLA-4, BTLA) members.
- Immunoreceptor tyrosine-based switch motifs (ITSM) in PD-1 and BTLA recruit the SHP-2 (and possibly SHP-1) phosphatase, while a YVKM motif in CTLA-4 recruits SHP-2 and PP2A phosphatases.

- These phosphatases dephosphorylate signaling molecules involved in T-cell activation, such as phosphatidylinositol 3-kinase.

Immunoregulation by T-cells

- Regulatory T-cells (Tregs) can suppress the activity of both helper and cytotoxic T-cells as well as dendritic cell and B-cell activity.
- Effectors of suppression include naturally occurring CD4⁺CD25⁺Foxp3⁺ Treg, which arise directly in the thymus, and inducible Tregs, which express Foxp3 only after their activation in the periphery. These both seem to act predominantly via cell contact-dependent mechanisms.
- Other types of regulatory T-cells act by secreting immunosuppressive cytokines, with Tr1 cells producing IL-10 and Th3 cells that release TGFβ. Immunoregulatory γδ T-cells, CD8⁺ T-suppressor cells, some NKT cells, regulatory B-cells, and myeloid-derived suppressor cells can also contribute to the inhibition of immune responses.
- Th1 and Th2 cells mutually inhibit each other through production of their respective cytokines IFNγ and IL-4/IL-13.
- Tregs and Th17 cells also exhibit a reciprocal relationship. The Foxp3 transcription factor associated with regulatory T-cell activity blocks the RORγt transcription factor required for Th17 cell activity.

Regulatory immunoneuroendocrine networks

- Immunological, neurological and endocrinological systems interact, forming regulatory circuits.
- Feedback by cytokines augments the production of corticosteroids and is important because this shuts down Th1 and macrophage activity.
- Estrogens can enhance both T- and B-cell responses, but can also promote the activity of regulatory cells.

Dietary effects on immunity

- Protein-calorie malnutrition grossly impairs cell-mediated immunity and phagocyte microbicidal potency.
- Polyunsaturated fatty acids downregulate the production of proinflammatory cytokines.
- Both vitamin A and vitamin D stimulate Th2 and Treg cells and thereby also inhibit Th1 and Th17 cells, respectively.

The influence of gender and aging

- Females often mount somewhat stronger immune responses than males.
- There is some evidence to suggest that sex hormones may contribute to gender differences in the immune response.
- The elderly are more prone to infection and respond less effectively to vaccines.

- The ability of phagocytic cells to both engulf and kill microorganisms decreases with age, as does the efficiency of dendritic cell homing to lymph nodes and their activation of T-cells.
- Involution of the thymus at puberty results in a reduced output of T-cells.
- CD4⁺ T-cell, CD8⁺ T-cell, and B-cell numbers all decline with age, although NK cell numbers increase.
- Terminally differentiated T-cells accumulate in response to latent infections, “crowding out” the ability to make adequate responses to newly encountered pathogens.
- The concentration of circulating antibody is often elevated in later life, but these antibodies tend to be of rather low affinity.
- Levels of the proinflammatory cytokines TNF, IL-1, and IL-6 also increase with age.



Now visit www.roitt.com to test yourself on this chapter.

FURTHER READING

- Basu R., Hatton R.D., and Weaver C.T. (2013) The Th17 family: flexibility follows function. *Immunological Reviews* **252**, 89–103.
- Brennan P.J., Brigl M., and Brenner M.B. (2013) Invariant natural killer T cells: an innate activation scheme linked to diverse effector functions. *Nature Reviews Immunology* **13**, 101–117.
- Burzyn D., Benoist C., and Mathis D. (2013) Regulatory T cells in nonlymphoid tissues. *Nature Immunology* **14**, 1007–1013.
- Carroll M.C. and Isenman D.E. (2012) Regulation of humoral immunity by complement. *Immunity* **37**, 199–207.
- Chen L. and Flies D.B. (2013) Molecular mechanisms of T cell co-stimulation and co-inhibition. *Nature Reviews Immunology* **13**, 227–242.
- Germain R.N. (2012) Maintaining system homeostasis: the third law of Newtonian immunology. *Nature Immunology* **13**, 902–906.
- Goronzy J.J. and Weyand CM. (2013) Understanding immunosenescence to improve responses to vaccines. *Nature Immunology* **14**, 428–436.
- Li M.O. and Rudensky A.Y. (2016) T cell receptor signalling in the control of regulatory T cell differentiation and function. *Nature Reviews Immunology* **16**, 220–233.
- Loftus R.M. and Finlay D.K. (2016) Immunometabolism: Cellular Metabolism Turns Immune Regulator. *Journal of Biological Chemistry* **291**, 1–10.
- Okazaki T., Chikuma S., Iwai Y., Fagarasan S., and Honjo T. (2013) A rheostat for immune responses: the unique properties of PD-1 and their advantages for clinical application. *Nature Immunology* **14**, 1212–1218.
- Orrù V., Steri M., Sole G., *et al.* (2013) Genetic variants regulating immune cell levels in health and disease. *Cell* **155**, 242–256.
- Riella L.V., Paterson A.M., Sharpe A.H., and Chandraker A. (2012) Role of the PD-1 pathway in the immune response. *American Journal of Transplantation* **12**, 2575–2587.
- Rosenblum M.D., Way S.S., and Abbas A.K. (2016) Regulatory T cell memory. *Nature Reviews Immunology* **16**, 90–101.
- Rosser E.C. and Mauri C. (2015) Regulatory B cells: origin, phenotype, and function. *Immunity* **42**, 607–612.
- Veldhoen M. and Brucklacher-Waldert V. (2012) Dietary influences on intestinal immunity. *Nature Reviews Immunology* **12**, 696–708.

CHAPTER 10

Development and evolution of the immune response

Key topics

ONTOGENY

- CD antigens 292
- Hematopoietic stem cells 292
- The thymus is required for T-cell development 292
- T-cell ontogeny 295
- T-cell tolerance 300
- B-cells differentiate in the fetal liver and then in bone marrow 304
- B-1 and B-2 cells represent two distinct populations 305
- Development of B-cell specificity 305
- B-cell tolerance 307
- Lymphocytes go through antigen-independent and antigen-dependent stages of differentiation 309
- Natural killer (NK) cell ontogeny 309
- Neonatal immunity 311

PHYLOGENY

- The evolution of the immune response 312
- The evolution of distinct B- and T-cell lineages was accompanied by the development of separate sites for differentiation 314
- Cellular recognition molecules exploit the immunoglobulin gene superfamily 314

Roitt's Essential Immunology, Thirteenth Edition. Peter J. Delves, Seamus J. Martin, Dennis R. Burton, and Ivan M. Roitt.
© 2017 John Wiley & Sons, Ltd. Published 2017 by John Wiley & Sons, Ltd.
Companion website: www.roitt.com

Just to recap ...

The immune system relies upon the cells of the innate and adaptive responses. Innate responses, which are not antigen specific and lack immunological memory, involve neutrophils, eosinophils, mast cells, basophils, monocytes, macrophages, NK cells, and various types of dendritic cell. In contrast the highly antigen-specific adaptive response, which characteristically develops immunological memory, is mediated by lymphocytes. These lymphocytes, which recombine antigen-receptor genes in order to generate a quite incredible diversity of antigen recognition, comprise the helper, regulatory, and cytotoxic T-cells and the antibody-producing B-cells.

Introduction

In this chapter we will look at the development (*ontogeny*) of the cells of the immune system in the individual, and the evolution (*phylogeny*) of the immune response from primitive species through to mammals.

Virtually all cells of the immune response, with the exception of the follicular dendritic cell, are derived from multipotent hematopoietic stem cells. These stem cells differentiate down various developmental pathways, with those that are destined to become T-lymphocytes having first to migrate to the thymus.

ONTOGENY

CD antigens

Analysis of the cells of the immune system often involves detection of cell surface molecules that allow scientists to differentiate one cell type from another. Indeed the expression of such molecules is very often associated with the differentiation of individual cells along developmental pathways. The detection of these so-called “cell surface markers” usually relies on using antibodies as probes for their expression. Immunologists from the far corners of the world who have produced monoclonal antibodies directed to surface molecules on B- and T-cells, macrophages, neutrophils, natural killer (NK) cells, and so on, get together every so often to compare the specificities of their reagents in international workshops whose spirit of cooperation should be a lesson to most politicians. When a cluster of monoclonal antibodies are found to react with the same polypeptide, they clearly represent a series of reagents defining a given marker and are assigned a CD (*cluster of differentiation*) number that defines the particular cell surface antigen recognized by these antibodies. By 2016 there were 371 designated CD antigens assigned, with some of them subdivided into different variants. Those listed in Table 10.1 are most relevant to our discussions, with a complete list available at www.hcdm.org/. It is important to appreciate that the expression level of cell surface molecules often changes as cells differentiate or become activated and that “subpopulations” of cells exist that differentially express particular molecules. When expressed at a low level the “presence” or “absence” of a given CD antigen

may be rather subjective, but be aware that low level expression does not necessarily imply biological irrelevance.

Hematopoietic stem cells

Hematopoiesis originates in the early yolk sac but, as embryogenesis proceeds, the function of providing niches where hematopoiesis occurs is taken over by the fetal liver and finally by the bone marrow where hematopoiesis continues throughout life. Multipotent *hematopoietic stem cells (HSCs)* give rise to the erythrocytes (red blood cells), the leukocytes (white blood cells), and the megakaryocytes, which generate platelets. These various cell types are often collectively referred to as the “formed elements of the blood” (Figure 10.1). The HSCs have a substantial capacity to renew themselves through the creation of further stem cells. Thus an animal can be completely protected against the lethal effects of high doses of irradiation by injection of bone marrow cells that will repopulate its lymphoid and myeloid systems. The capacity for self-renewal is not absolute and declines with age in parallel with a shortening of the telomeres.

The majority of HSCs in the mouse are CD34⁺, Sca-1⁺, CD150⁺, CD48⁻, flt3⁻, *c-kit* (CD117)⁺, and lin⁻, whereas the surface phenotype of the main population of human HSCs is CD34⁺, CD90 (Thy-1)⁺, CD38⁻, CD45RA⁻, and lin⁻. Impressively, as few as 10 HSCs can prevent death in lethally irradiated SCID mice.

In addition to the HSCs mentioned above, the bone marrow also contains *mesenchymal stem cells* which give rise to the *bone marrow stromal cells* that support hematopoiesis and under appropriate signals also differentiate into adipocytes (fat cells), osteocytes (bone cells), and chondrocytes (cartilage cells). The HSCs differentiate within the microenvironment of the stromal cells, which produce various growth factors including IL-2, -3, -4, -5, -6, -7, -11, and -15, G-CSF, GM-CSF, stem cell factor (SCF), flt3 ligand, erythropoietin (EPO), thrombopoietin (TPO), and so on. SCF remains associated with the extracellular matrix and acts on primitive stem cells through its receptor, the tyrosine kinase membrane receptor *c-kit*, to promote survival of HSCs by preventing their apoptosis. Hematopoiesis needs to be kept under tight control, for example by transforming growth factor β (TGF β), which exerts a cytostatic effect on HSCs.

Mice with severe combined immunodeficiency (SCID) provide an excellent environment for fragments of human fetal liver and thymus that, if implanted contiguously, will produce formed elements of the blood for 6–12 months.

The thymus is required for T-cell development

The thymus is organized into a series of lobules based upon meshworks of epithelial cells derived embryologically from an outpushing of the gut endoderm of the third pharyngeal pouch. These lobules form well-defined cortical and medullary zones (Figure 10.2) with the epithelial cells providing the microenvironment for T-cell differentiation. The cortical and

Table 10.1 Some of the major clusters of differentiation (CD) markers on human cells.

CD	Expression	Functions
CD1	IDC, B subset	Presents glycolipid and other nonpeptide antigens to T-cells
CD2	T, NK	Receptor for CD58 (LFA-3) co-stimulator
CD3	T	Signal transducing unit of the T-cell receptor
CD4	MHC class II restricted T, IDC, Mo, Mφ	Receptor for MHC class II
CD5	T, B subset	Involved in antigen receptor signaling
CD8	MHC class I restricted T	Receptor for MHC class I
CD16	G, NK, B, Mφ, IDC	FcγRIII (medium-affinity IgG receptor)
CD19	B, FDC	Part of B-cell antigen receptor complex
CD20	B	Provides signals for B cell activation and proliferation
CD21	B, FDC	CR2. Receptor for C3d and Epstein–Barr virus. Part of B-cell antigen receptor complex
CD23	B, Mo, FDC	FcεRII (low-affinity IgE receptor)
CD25	*T, *B, *Mo, *Mφ	IL-2 receptor α chain
CD28	T, *B	Receptor for CD80/CD86 (B7.1 and B7.2) co-stimulators
CD32	B, Mo, Mφ, IDC, FDC, G, NK	FcγRII (low-affinity IgG receptor)
CD40	B, Mφ, IDC, FDC	Receptor for CD154 (CD40L) co-stimulator
CD45RA	Resting/Naive T-cells, B, G, Mo, NK	Phosphatase, cell activation
CD45RO	Effector T-cell, Mo, Mφ, IDC	Phosphatase, cell activation
CD64	Mo, Mφ, IDC	FcγRI (high-affinity IgG receptor)
CD79a/CD79b	B	Igα/Igβ-transducing elements of B-cell receptor
CD80	*B, *T, Mφ, IDC	B7.1 receptor for CD28 co-stimulator and for CTLA4 inhibitory signal
CD86	B, IDC, Mo	B7.2 receptor for CD28 co-stimulator and for CTLA4 inhibitory signal
CD95	Widespread	Fas receptor for FasL (CD178). Transmits apoptotic signals

A complete list can be found on the Browse section of the Human Cell Differentiation Molecules database: www.hcdm.org/

* , activated; B, B-lymphocytes; FDC, follicular dendritic cells; G, granulocytes; IDC, interdigitating dendritic cells; Mast, mast cells; Mφ, macrophages; Mo, monocytes; NK, natural killer cells; T, T-lymphocytes.

the medullary thymic epithelial cells express MHC class I and class II molecules and are therefore able to present antigen to the developing T-cells. In both neonatal and adult mice T-cell progenitors arrive from the bone marrow in waves of immigration, and interactions occur between the extracellular matrix proteins and a variety of adhesion/homing molecules that include CD44 and the α_6 integrin. Several chemokines also play an essential role, with CXCL12 (stromal cell-derived factor-1, SDF-1) being a particularly potent chemoattractant for the CXCR4⁺ T-progenitor cells in humans.

Thymic hormones

The thymic epithelial cells produce a series of peptide hormones, including thymulin, thymosin α_1 , thymic humoral factor (THF), and thymopoietin (and its active pentapeptide

thymopontin, TP-5), that are capable of promoting the appearance of T-cell differentiation markers and a variety of T-cell functions on culture with HSCs *in vitro*. The circulating levels of these hormones *in vivo* begin to decline from puberty onwards, reaching vanishingly small amounts by the age of 60 years. Only thymulin is of exclusively thymic origin. This zinc-dependent nonapeptide tends to normalize the balance of immune responses: it restores antibody avidity and antibody production in aged mice and yet stimulates suppressor activity in animals with autoimmune hemolytic anemia induced by cross-reactive rat erythrocytes. Thymulin may be looked upon as a true hormone, secreted by the thymus in a regulated fashion and acting at a distance from the thymus as a fine physiological immunoregulator contributing to the maintenance of T-cell subset homeostasis.

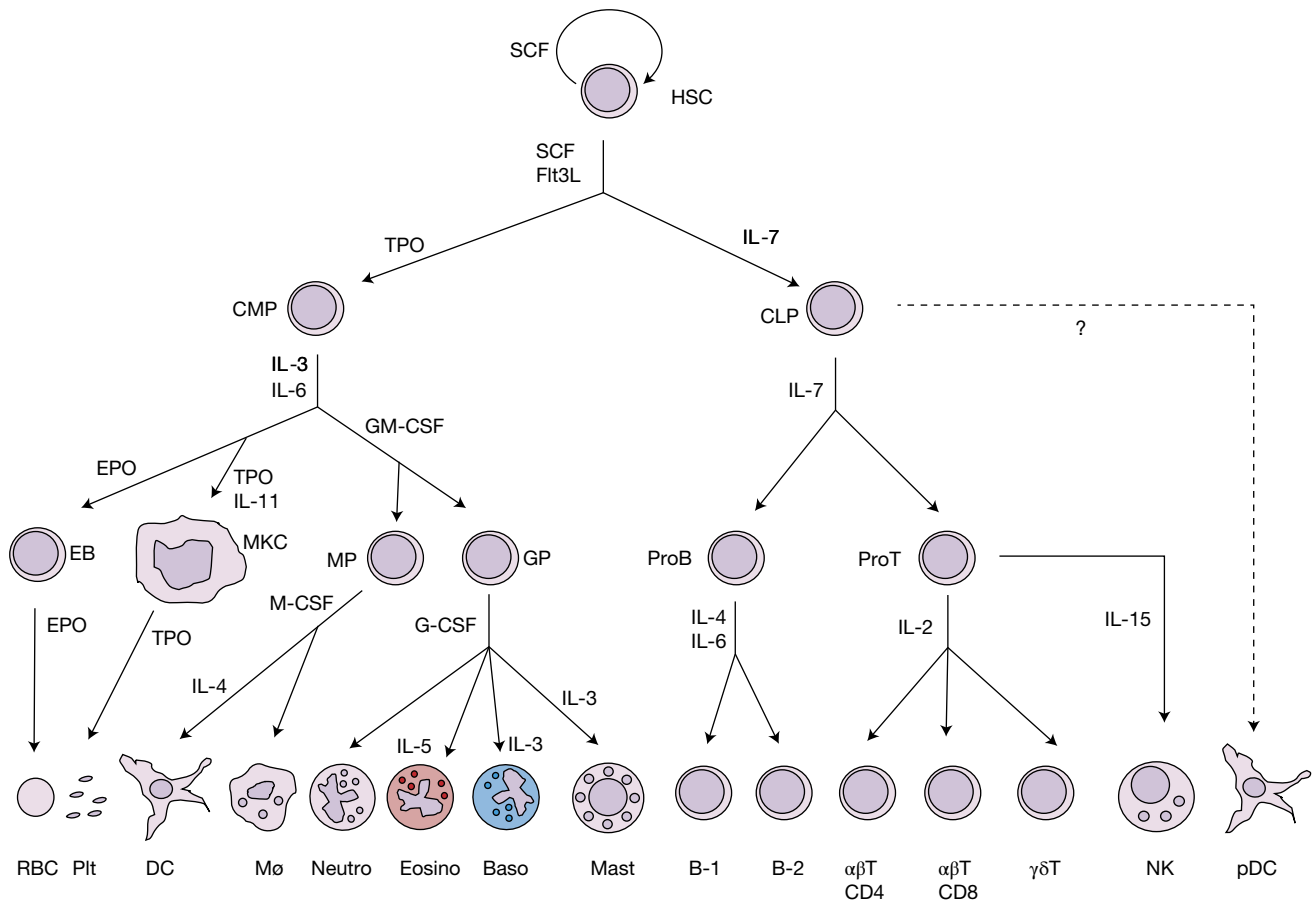


Figure 10.1 The multipotential hematopoietic stem cell and its progeny, which differentiate under the influence of a series of soluble cytokines and growth factors within the microenvironment of the bone marrow. The expression of various nuclear transcription factors (not shown) directs the differentiation process. For example, the *Ikaros* gene encodes a zinc-fingered transcription factor critical for driving the development of a common myeloid/lymphoid precursor into a lymphoid-restricted progenitor, giving rise to T-, B-, and NK cells. Both conventional and plasmacytoid dendritic cells can be derived from the myeloid pathway, and it is possible that the plasmacytoid dendritic cells can also be derived from the common lymphoid progenitor. Growth factors/cytokines: EPO, erythropoietin; Flt3L, FMS-like tyrosine kinase-3 ligand; G-CSF, granulocyte colony-stimulating factor; GM-CSF, granulocyte-macrophage colony-stimulating factor (so-called because it promotes the formation of mixed colonies of these two cell types from bone marrow progenitors either in tissue culture or on transfer to an irradiated recipient where colonies appear in the spleen); IL-3, interleukin-3 (often termed multi-CSF because it stimulates progenitors of platelets, erythrocytes, all the types of myeloid cells, and also plasmacytoid dendritic cells); M-CSF, monocyte colony-stimulating factor; SCF, stem cell factor; TPO, thrombopoietin. Cells: B-1 and B-2, B-cell subpopulations; Baso, basophil; EB, erythroblast, CLP, common lymphoid progenitor; CMP, common myeloid progenitor; Eosino, eosinophil; GP, granulocyte progenitor; HSC, hematopoietic stem cell; Mφ, macrophage; Mast, mast cell; DC, myeloid dendritic cell; MKC, megakaryocyte; MP, monocyte/macrophage/DC progenitor; Neutro, neutrophil; NK, natural killer; Plt, platelets; pDC, plasmacytoid dendritic cell; RBC, red blood cell.

Cellular interactions in the thymus

Specialized large epithelial cells in the outer cortex, known as “nurse” cells (Figure 10.2b), are associated with large numbers of lymphocytes that lie within pockets produced by the long membrane extensions of these cells. The epithelial cells of the deep cortex have branched processes, rich in class II MHC, and connect through specialized cell junctions called desmosomes to form a network through which cortical lymphocytes must pass on their way to the medulla. Conventional myeloid dendritic cells are able to migrate from the periphery into the cortex and

perivascular spaces. The cortical lymphocytes are densely packed compared with those in the medulla (Figure 10.2a), many are in cell division, and large numbers of them are undergoing apoptosis. On their way to the medulla, the lymphocytes pass a cordon of “sentinel” macrophages and plasmacytoid dendritic cells at the corticomedullary junction. In addition to migrating into the cortex, other myeloid dendritic cells are resident in the medulla. Keratinized epithelial cells in the medulla form the highly characteristic Hassall’s corpuscles, which have a whorled structure (Figure 10.2b) and serve as a

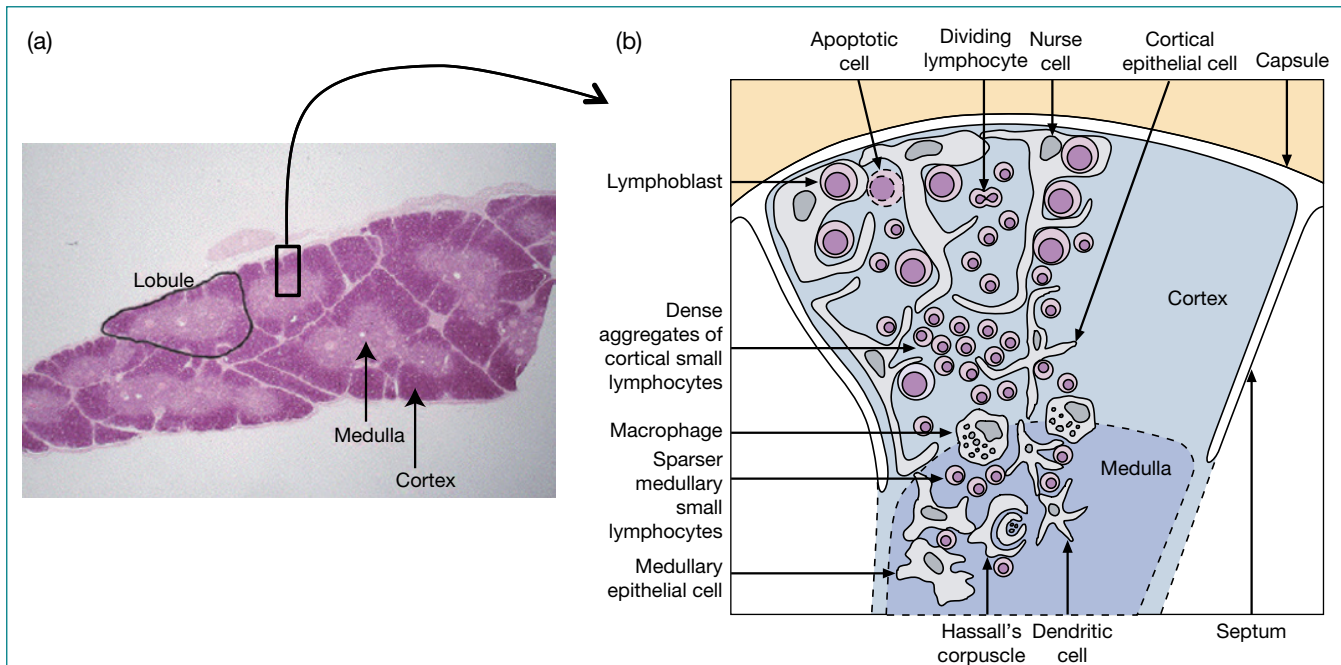


Figure 10.2 The thymus. (a) The thymus is partially divided into lobules by connective tissue septa. Note the discrete outer cortex and inner medulla apparent within each lobule. (Source: Rand S. Swenson, Dartmouth Medical School.) (b) Cellular features of a thymus lobule. See text for description. (Adapted from Hood L.E. *et al.* (1984) *Immunology*, 2nd edn. Benjamin Cummings, California, p. 261.)

disposal system for dying thymocytes, perhaps following their phagocytosis by dendritic cells.

In the human the thymus begins to involute (shrink) within the first 12 months of life. The thymic epithelial space, where T-cells are generated, becomes reduced. This involution continues throughout life, with an estimated reduction of around 3% a year through middle age (35–45 years) and approximately 1% annual reduction thereafter. Indeed the first 12 months of life is when T-cell production is at its most vigorous. Not only is there a progressive reduction in the size of the thymus but there is also replacement of thymocytes by connective and adipose tissue, so the generation of T-cells actually declines even more than might appear to be the case based only on the size of the organ. In a sense, the thymus is increasingly disposable because, as we shall see, it establishes a long-lasting peripheral T-cell pool that enables the host to withstand its loss without catastrophic failure of immunological function – witness the minimal effects of thymectomy in the adult compared with the *dramatic influence in the neonate* (Milestone 10.1). Nevertheless, the adult thymus retains some cortical and medullary tissue containing a normal range of thymocyte subsets with a broad spectrum of TCR gene rearrangements. Adult patients receiving either T-cell-depleted bone marrow or peripheral blood hematopoietic stem cells following ablative therapy are able to generate new naive T-cells at a rate that is inversely related to the age of the individual. These observations establish that new T-cells are generated in adult life, albeit at a lower rate than during the first few years of life.

Bone marrow stem cells become immunocompetent T-cells in the thymus

The evidence for this comes from experiments on the reconstitution of irradiated hosts. An irradiated animal that is given a bone marrow graft will eventually replenish the T- and B-cells destroyed by irradiation. However, if the animal is thymectomized before irradiation, bone marrow cells will not reconstitute the T-lymphocyte population.

By days 11–12 in the mouse embryo, lymphoblastoid stem cells from the bone marrow begin to colonize the periphery of the epithelial thymus rudiment. If the thymus is removed at this stage and incubated in organ culture, a whole variety of mature T-lymphocytes will be generated. This generation is not seen if 10-day thymuses are cultured, and shows that the lymphoblastoid colonizers give rise to the immunocompetent small lymphocyte progeny.

T-cell ontogeny

Differentiation is accompanied by changes in surface markers

T-cell progenitors arriving from the bone marrow enter the thymus through venules at the corticomedullary junction. The developing T-cells in the thymus are referred to as thymocytes. The newly arrived early thymocytes lack both the CD4 and CD8 co-receptors and are therefore referred to as *double-negative (DN)* cells (Figure 10.3). They do, however, possess certain chemokine receptors such as CCR7 and CCR9. Under the



Milestone 10.1 The immunological function of the thymus

Ludwig Gross had found that a form of mouse leukemia could be induced in low-leukemia strains by inoculating filtered leukemic tissue from high-leukemia strains provided that this was done in the immediate neonatal period. As the thymus was known to be involved in the leukemic process, Jacques Miller decided to test the hypothesis that the Gross virus could only multiply in the neonatal thymus by infecting neonatally thymectomized mice of low-leukemia strains. The results were consistent with this hypothesis but, strangely, animals of one strain died of a wasting disease that Miller deduced could have been due to susceptibility to infection, as fewer mice died when they were moved from the converted horse stables, which served as an animal house, to “cleaner” quarters.

Autopsy showed the animals to have atrophied lymphoid tissue and low blood lymphocyte levels, and Miller therefore decided to test their immunocompetence before the onset of wasting disease. To his astonishment, skin grafts, even from rats (Figure M10.1.1) as well as from other mouse strains, were fully accepted. These phenomena were not induced by thymectomy later in life and, in writing up his preliminary

results in 1961 (Miller J.F.A.P., *Lancet* ii, 748–749), Miller suggested that “during embryogenesis the thymus would produce the originators of immunologically competent cells, many of which would have migrated to other sites at about the time of birth.” All in all a superb example of the scientific method and its application by a top-flight scientist.



Figure M10.1.1 Acceptance of a rat skin graft by a mouse that had been neonatally thymectomized.

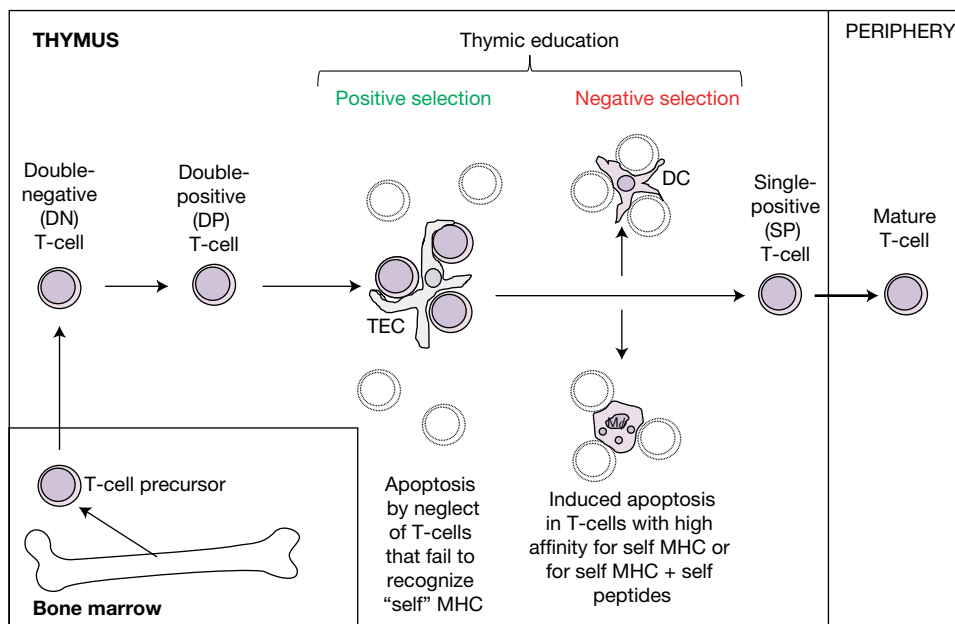


Figure 10.3 Thymic education. Precursors of the T-cells migrate from the bone marrow to the thymus. They lack a TCR and do not express either CD4 or CD8, (i.e., they are “double negative” [DN]). Following a productive recombination of their T-cell receptor (TCR) α -chain and TCR β -chain genes T-cells express a cell surface TCR together with both CD4 and CD8 to become “double-positive” (DP) cells. Positive selection on thymic epithelial cells (TEC) that express both MHC class I and MHC class II, rescues cells from a “default” pathway of apoptosis, which would occur through neglect of these cells. As long as they have generated a TCR able to recognize “self” MHC with a low or intermediate affinity they are saved from neglect and these rescued cells are then protected from apoptosis unless they subsequently undergo negative selection because of high-affinity interaction of their TCR with self MHC or self MHC + self peptides present on dendritic cells (DC) and macrophages (Mφ). The CD4⁺CD8⁻ and CD4⁻CD8⁺ single-positive (SP) T-cells that exit the thymus therefore possess a TCR with the potential to detect foreign peptides presented by “self” MHC.

influence of chemokines including CCL19 and CCL21 (detected by CCR7) and CCL25 (recognized by CCR9), the thymocytes migrate through the thymic cortex towards the outer subcapsular zone before they express a randomly generated TCR and also switch on expression of both CD4 and CD8 to become **double-positive (DP)** cells. They then undergo a process referred to as thymic education, which com-

prises two steps – positive selection and negative selection (Figure 10.3) – to ensure that the **single-positive (SP)** CD4 or CD8 cells that exit the thymus bear a TCR that can recognize peptides derived from foreign antigens presented by that individual's own MHC variants.

The earliest of these progenitors, the DN1 cells (Figure 10.4), retain multipotentiality and express high levels

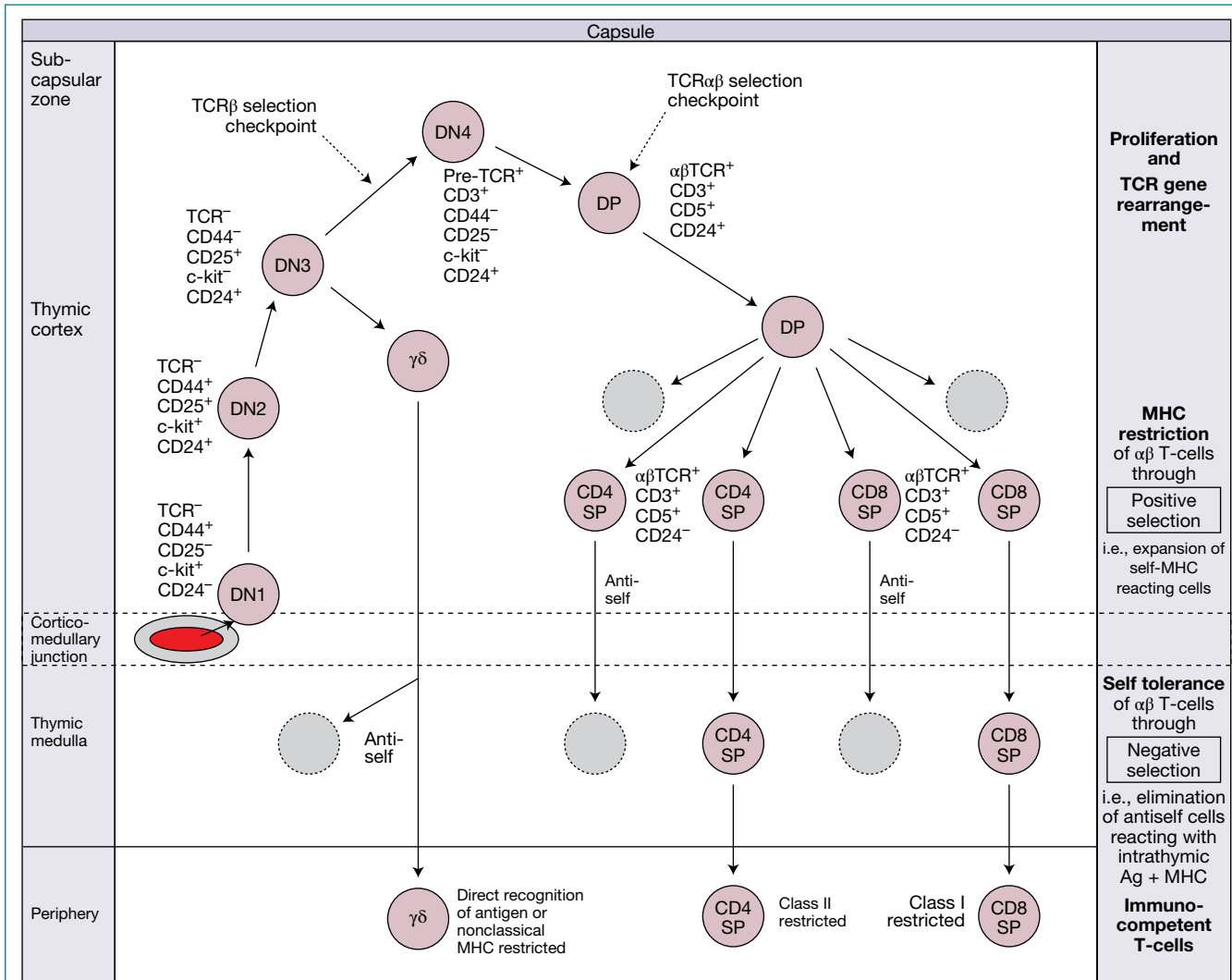


Figure 10.4 Differentiation of T-cells within the thymus. T-cell precursors arriving from the bone marrow enter the thymus via blood vessels at the cortico-medullary junction. The transition between the different populations of CD4⁻CD8⁻ (double-negative, DN) T-cell precursors in the thymus is marked by the differential expression of CD44, CD25, *c-kit*, and CD24. DN3 cells are unable to progress to the DN4 stage unless they successfully rearrange one of their two T-cell receptor (TCR) β-chain gene loci. Successful rearrangement of the TCR α-chain to form the mature receptor is obligatory for differentiation beyond the early CD4⁺CD8⁺ (double-positive, DP) stage. The double-positive T-cells that bear an αβ TCR are subjected to positive and negative selection events, the “useless” T-cells (i.e., those unable to recognize self MHC) that die by neglect during positive selection and the self-reactive negatively selected cells are indicated in gray. Autoreactive cells with specificity for self antigens not expressed in the thymus may be tolerized by extrathymic peripheral contact with antigen. γδ T-cells, which develop from the DN3 T-cell precursors, mainly appear to recognize antigen directly, in a manner analogous to the antibody molecule on B-cells, although some are restricted by nonclassical MHC-like molecules. Details and location of positive and negative selection events for γδ T-cells are not well characterized. NKT cells, which are not shown in the diagram for the sake of simplicity, arise from the double-positive T-cells to become CD4⁺CD8⁻, CD4⁻CD8⁻, or CD4⁻CD8⁺ cells bearing an invariant αβ TCR and the NK1.1 marker. They usually recognize antigens presented by CD1d.

of the adhesion molecule CD44 and the stem cell factor (SCF) receptor (*c-kit*, CD117). As they mature into DN2 cells, they begin to express CD24 and the IL-2 receptor α chain (CD25). These cells become increasingly restricted to producing T-cells and T-cell development is severely impaired in *Notch-1*^{-/-} knockout mice, signaling via the Notch-1 cell surface molecule being necessary for T-cell lineage commitment of the DN1 and DN2 cells. Indeed, the Notch-1 ligands with the rather exotic names of Jagged-1, Jagged-2, δ -like-1, and δ -like-4 are expressed on thymic epithelial cells in a highly regulated way. Further differentiation into DN3 cells with the loss of CD44 and *c-kit*, and a downregulation of CCR7 expression, accompanies their arrival in the subcapsular zone. Transient expression of the recombination-activating genes *RAG-1* and *RAG-2*, together with an increase in chromatin accessibility, permits recombination of TCR γ -chain and δ -chain genes or of the TCR β -chain genes during the DN2 and DN3 stages, resulting in final commitment to the T-cell lineage. The $\gamma\delta$ T-cells branch off at the DN3 stage and express CD3, the signal transducing complex of the TCR. $\gamma\delta$ T-cell development at this stage requires expression of the SOX13 transcription factor. Those cells that are destined to employ an $\alpha\beta$ TCR transition from DN3 to DN4, and also express CD3. The loss of CD25 signifies passage of the $\alpha\beta$ T-cell precursors into the DN4 population, which subsequently differentiate into the CD4⁺ (the marker for MHC class II recognition) and CD8⁺ (class I recognition) **double-positive (DP)** thymocytes. TCR α -chain gene rearrangement occurs when *RAG-1* and *RAG-2* are again transiently expressed immediately following expression of CD4 and CD8.

The DP thymocytes re-express CCR7, causing them to migrate from the subcapsular zone back through the cortex, eventually crossing the corticomedullary junction into the medulla. Expression of either CD4 or CD8 is lost as the DP thymocytes differentiate into **single-positive (SP) CD4⁺** (mostly **T-helpers and regulatory T-cells**) and **CD8⁺** (mostly **cytotoxic T-cell precursors**). Note that the $\gamma\delta$ cells remain double negative (i.e., CD4⁻CD8⁻, except for a small subset that express CD8).

In addition to the factors mentioned above, thymocyte development is critically dependent on IL-7, which is produced locally by the thymic epithelial cells and is necessary for the transition to the DN3 stage. Signaling through the IL-7 receptor and *c-kit* also help drive the early extensive proliferation that occurs in thymocytes prior to the rearrangement of the TCR genes

The factors that determine whether the double-positive cells become single-positive CD4⁺ class II-restricted cells or CD8⁺ class I-restricted cells in the thymus are still not fully established. Two major scenarios have been put forward. The **stochastic/selection** hypothesis suggests that expression of either the CD4 or CD8 co-receptor is randomly switched off and then cells that have a TCR-co-receptor combination capable of recognizing an appropriate peptide-MHC are selected for survival. By contrast, the **instructive** hypothesis declares

that interaction of the TCR with MHC-peptide results in signals that instruct the T-cells to switch off expression of the “useless” co-receptor incapable of recognizing that particular class of MHC. In order to reconcile the fact that there are supporting data for both hypotheses, various other models have been put forward, including proposals that stronger **signal strength** or longer **signal duration** favors CD4 cell development. These various models are still the subject of debate among the immunological community. What is fairly clear, however, is that expression of the transcription factors Th-POK and GATA3 are important for CD4⁺ T-cell development, whereas production of the transcription factor RUNX3 favors CD8⁺ T-cell development.

NKT cells constitute a distinct subset of $\alpha\beta$ T-cells

NKT cells, which branch from conventional T-cells at the double-positive stage of thymocyte development, express markers associated with both T-cells and NK cells, such as a TCR and the C-lectin-type receptor NK1.1, respectively. The TCR of NKT cells is mostly composed of an invariant TCR α chain (V α 14 J α 18 in mice, V α 24J18 in human) together with a V β 8 (mouse) or V β 11 (human) β chain. They recognize glycolipids such as the endogenous lysosomal isoglobotrihexosylceramide (iGb3) and the microbial antigen phosphatidylinositol mannoside from mycobacteria. These antigens are presented to the invariant TCR by the nonpolymorphic MHC class I-like CD1d molecule, and when activated, the NKT cells secrete large amounts of cytokines including IFN γ and IL-4 (i.e., both Th1- and Th2-type cytokines). It has been proposed that NKT cells may function primarily as regulatory cells.

The development of $\alpha\beta$ receptors

Rearrangement of *V*, *D*, and *J* region genes are required to generate the TCR (see Chapter 4). By day 15 of fetal development cells with the $\gamma\delta$ TCR can be detected in the mouse thymus followed soon after by the appearance of a “**pre-TCR**” version of the $\alpha\beta$ TCR. The TCR β -chain gene is usually rearranged at the DN3 stage and associates with an invariant pre- α chain, pT α , to form a “pre-TCR,” functional rearrangement of the β chain being required for transition to the DN4 stage (Figure 10.4). Signaling through the pre-TCR occurs in a ligand-independent manner whereby the pre-TCR molecules constitutively target to lipid rafts. Activation of signaling cascades involving Ras/MAPK and phospholipase C γ 1 pathways recruit Ets-1 and other transcription factors, stimulating the proliferation and differentiation of DN3 cells into DN4 and subsequently into DP cells, as well as mediating feedback inhibition on further TCR *V β* gene rearrangement. Subsequent development of pre-T-cells requires rearrangement of the *V α* gene segments so allowing formation of the mature $\alpha\beta$ TCR.

Rearrangement of the *V β* genes on the sister chromatid is suppressed following the expression of the pre-TCR (remember each cell contains two chromosomes for each α and β cluster). Thus each cell only expresses a single TCR β chain and

the process by which the homologous genes on the sister chromatid are suppressed is called **allelic exclusion and is also seen in the immunoglobulin gene loci**. This exclusion is at least partially due to the methylation of histones maintaining a closed chromatin structure that prevents access of the recombinases to the TCR gene segments on the excluded allele.

The α chains are not always allelically excluded, so that many immature T-cells in the thymus have two antigen-specific receptors, each with their own α chain but sharing a common β chain. However, expression of one of the α chains is usually lost during T-cell maturation, leaving the cell with a single-specificity $\alpha\beta$ TCR. Nonetheless, around 1–8% of peripheral T-cells in both mice and humans have cell surface TCRs that all have the same β chain but can employ one of two different α chains. These dual-specificity T-cells may extend the TCR repertoire to include recognition of foreign antigen peptides that would not otherwise be selected in the thymus.

The development of $\gamma\delta$ receptors

Unlike the $\alpha\beta$ TCR, the $\gamma\delta$ TCR in many cases seems to be able to bind directly to antigen without the necessity for antigen presentation by MHC or MHC-like molecules (i.e., it recognizes antigen directly in a manner similar to antibody). The $\gamma\delta$ lineage does not produce a “pre-receptor,” and mice expressing rearranged γ and δ transgenes do not rearrange any further γ or δ gene segments, indicating allelic exclusion of sister chromatid genes.

$\gamma\delta$ T-cells in the mouse, unlike the human, predominate in association with epithelial cells. A curious feature of the cells leaving the fetal thymus is the restriction in V gene utilization. Virtually all of the first wave of fetal $\gamma\delta$ cells express $V\gamma 5$ and colonize the skin; the second wave predominantly utilizes $V\gamma 6$ and seed the uterus in the female. In adult life, there is far more receptor diversity due to a high degree of junctional variation, although the intraepithelial cells in the intestine preferentially use $V\gamma 4$ and those in encapsulated lymphoid tissue tend to express $V\gamma 4$, $V\gamma 1.1$, and $V\gamma 2$. It should be noted that, just to confuse everyone, other nomenclatures exist regarding the numbering of the individual murine $V\gamma$ genes. The $V\gamma$ set in the skin readily proliferates and secretes IL-2 on exposure to heat-shocked keratinocytes, implying a role in the surveillance of trauma signals. The $\gamma\delta$ T-cells in peripheral lymphoid tissue respond well to the tuberculosis antigen PPD (“purified protein derivative”) and to conserved epitopes from mycobacterial and self-heat-shock protein hsp65. However, evidence from $\gamma\delta$ TCR knockout mice suggests that overall, in the adult, $\gamma\delta$ T-cells may make a minor contribution to pathogen-specific protection. Two major $\gamma\delta$ subsets predominate in the human, $V\gamma 9 V\delta 2$ and $V\gamma 1 V\delta 2$. The $V\gamma 9$ set rises from 25% of the total $\gamma\delta$ cells in cord blood to around 70% in adult blood; at the same time, the proportion of $V\gamma 1$ falls from 50% to less than 30%. The majority of the $V\gamma 9$ set have the activated memory phenotype CD45RO, probably as a result of stimulation by common ligands for the $V\gamma 9 V\delta 2$ TCR such as

nonproteinaceous phosphate-bearing antigenic components of mycobacteria, *Plasmodium falciparum* and the superantigen staphylococcal enterotoxin A.

Cells are positively selected in the thymus for self-MHC recognition

The ability of T-cells to recognize antigenic peptides in association with self-MHC is developed in the thymus. If an $H-2^k \times H-2^b$ F1 animal is sensitized to an antigen, the primed T-cells can recognize that antigen on presenting cells of either $H-2^k$ or $H-2^b$ haplotype (i.e., the mice can use either parental haplotype as a recognition restriction element). However, if bone marrow cells from the $H-2^k \times H-2^b$ F1 are used to reconstitute an irradiated F1 that had earlier been thymectomized and given an $H-2^k$ thymus, the subsequently primed T-cells can only recognize antigens in the context of $H-2^k$, not of $H-2^b$ (Figure 10.5). Thus it is **the phenotype of the thymus that imprints $H-2$ restriction** on the differentiating T-cells.

It will also be seen in Figure 10.5 that incubation of the thymus graft with deoxyguanosine, which destroys the cells of macrophage and dendritic cell lineage, has no effect on imprinting, suggesting that this function is carried out by epithelial cells. Confirmation of this comes from a study showing that lethally irradiated $H-2^k$ mice, reconstituted with $b \times k$ F1 bone marrow and then injected intrathymically with an $H-2^b$ thymic epithelial cell line, developed T-cells restricted by the b haplotype. The epithelial cells are rich in both MHC class I and class II cell surface molecules and the current view is that double-positive ($CD4^+CD8^+$) T-cells bearing receptors that recognize self-MHC on the epithelial cells are positively selected for differentiation to $CD4^+CD8^-$ or $CD4^-CD8^+$ single-positive cells. The evidence for this comes largely from studies in transgenic mice. We would like to cite an experimental example; nonprofessionals may need to hang on to their haplotypes, put on their ice-packs and concentrate.

One highly sophisticated study starts with a cytotoxic T-cell clone raised in $H-2^b$ females against male cells of the same strain. The clone recognizes a peptide derived from the male antigen, H-Y, and this is seen in association with the $H-2D^b$ self-MHC molecules. The α and β chains for the T-cell receptor of this clone are now introduced as transgenes into SCID mice, which lack the ability to rearrange their own germline variable region receptor genes; thus the only TCR that could possibly be expressed is that encoded by the transgenes, provided of course that we are looking at females rather than males (in whom the clone would be eliminated by self-reactivity). If the transgenic SCID females bear the original $H-2^b$ haplotype (e.g., F1 hybrids between $b \times d$ haplotypes), then the anti- $H-2^b$ /H-Y peptide receptor is amply expressed on $CD8^+$ cytotoxic precursor cells (Table 10.2a), whereas $H-2^d$ transgenics lacking $H-2^b$ produce only double-positive $CD4^+CD8^+$ thymocytes with no single-positive $CD4^+CD8^-$ or $CD4^-CD8^+$ cells. Thus, as $CD4^+CD8^+$ cells express their TCR






Thymectomize $b \times k$ mice	Graft with thymus of haplotype	Irradiate and reconstitute with $b \times k$ bone marrow	Prime with KLH	Proliferative response of primed T-cells to KLH on antigen-presenting cells of haplotype	
				$H-2^b$	$H-2^k$
	$b \times k$	→	→	++	++
	b	→	→	++	-
	dGuo- treated b	→	→	++	-
	k	→	→	-	++
	dGuo- treated k	→	→	-	++

Figure 10.5 Imprinting of H-2T-helper restriction by the haplotype of the thymus. Host mice were first generation (F1) crosses between strains of haplotype $H-2^b$ and $H-2^k$. They were thymectomized and grafted with 14-day fetal thymuses, irradiated and reconstituted with F1 bone marrow. After priming with the antigen keyhole limpet hemocyanin (KLH), the proliferative response of lymph node T-cells to KLH on antigen-presenting cells of each parental haplotype was assessed. In some experiments, the thymus lobes were cultured in deoxyguanosine (dGuo), which destroys intrathymic cells of macrophage/dendritic cell lineage, but this had no effect on positive selection. (Source: Lo D. and Sprent J. (1986) *Nature* **319**, 672–675. Reproduced with permission of Nature Publishing Group.)

Table 10.2 Positive and negative selection in SCID transgenic mice bearing the $\alpha\beta$ receptors of an $H-2D^b$ T-cell clone cytotoxic for the male antigen H-Y (i.e., the clone is of $H-2^b$ haplotype and is female anti-male). (a) The only T-cells are those bearing the already rearranged transgenic TCR, as SCID mice cannot rearrange their own V genes. The clones are only expanded beyond the $CD4^+CD8^+$ stage when positively selected by contact with the MHC haplotype ($H-2^b$) recognized by the original clone from which the transgene was derived. Also, as the TCR recognized class I, only $CD8^+$ cells were selected. (b) When the anti-male transgenic clone is expressed on intrathymic T-cells in a male environment, the strong engagement of the TCR with male antigen-bearing cells eliminates them.

Phenotype of thymocytes	(a) Positive selection		(b) Negative selection	
	Haplotype of transgenic females		Transgenic $H-2^b$ mice	
	$H-2^{bd}$	$H-2^{dd}$	Males	Females
$CD4^-CD8^-$ TCR ⁻	+	++	+++	+
$CD4^+CD8^+$ TCR [±]	++	+	-	+++
$CD4^-CD8^+$ TCR ⁺⁺	+	-	-	+
$CD4^+CD8^-$ TCR ⁺⁺	-	-	-	-

Data source: von Boehmer H. *et al.* (1989) In *Progress in Immunology*, Vol. 7 (eds. Melchers F. *et al.*). Springer-Verlag, Berlin, p. 297. +, crude measure of the relative numbers of T-cells in the thymus having the phenotype indicated.

transgene, they only differentiate into $CD8^+$ immunocompetent cells if they come into contact with thymic epithelial cells of the MHC haplotype recognized by their receptor. We say that such self-recognizing thymocytes are being **positively selected**. Intracellular signaling accompanies the positive selection, with the protein tyrosine kinases *fyn* and *lck* being activated in double-positive $CD4^+CD8^+$ thymocytes maturing to single-positive $CD8^+$ cells.

T-cell tolerance

The induction of immunological tolerance is necessary to avoid self-reactivity

In essence, lymphocytes use receptors that recognize foreign antigens through complementarity of shape. In the case of B-cells this is the shape of the antigen alone, but of course T-cells are recognizing the structures created when peptide binds to

MHC. To a large extent the building blocks used to form microbial and host molecules are the same, and so it is the assembled shapes of *self* and *nonself* molecules that must be discriminated by the immune system if potentially disastrous autoreactivity is to be avoided. The restriction of each lymphocyte to a single specificity makes the job of establishing self-tolerance that much easier, simply because it just requires a mechanism that functionally deletes self-reacting cells and leaves the remainder of the repertoire unscathed. The most radical difference between self and nonself molecules lies in the fact that, in early life, the developing lymphocytes are

surrounded by self and normally only meet nonself antigens at a later stage and then within the context of the adjuvanticity and cytokine release usually associated with infection. Evolution has exploited these differences to establish the mechanisms of *immunological tolerance to self* (Milestone 10.2).

Self-tolerance is induced in the thymus

As developing T-cells are to be found in the thymus, one might expect this to be the milieu in which exposure to self antigens on the surrounding cells would induce tolerance. It is a



Milestone 10.2 The discovery of immunological tolerance

In the mid-1940s, John Owen made the intriguing observation that non-identical (dizygotic) twin cattle, which shared the same placental circulation and whose circulations were thereby linked, grew up with appreciable numbers of red cells from the other twin in their blood; if they had not shared the same circulation at birth, red cells from the twin injected in adult life would have been rapidly eliminated by an immunological response. From this finding, Frank Macfarlane Burnet and Frank Fenner conceived the notion that potential antigens that reach the lymphoid cells during their developing immunologically immature phase can in some way specifically suppress any future response to that antigen when the animal reaches immunological maturity. This, they considered, would provide a means whereby unresponsiveness to the body's own constituents could be established and thereby enable the lymphoid cells to make the important distinction between "self" and "nonself." On this basis, any foreign cells introduced into the body during immunological development should trick the animal into treating them as "self" components in later life, and the studies of Peter Medawar and his colleagues have shown that **immunological tolerance**, or unresponsiveness, can be artificially induced in this way. Thus neonatal injection of CBA mouse cells into newborn A strain animals suppresses their ability to reject a CBA graft immunologically in adult life (Figure M10.2.1). Tolerance can also be induced with soluble antigens; for example, rabbits injected with bovine serum albumin without adjuvant at birth fail to make antibodies on later challenge with this protein.

Persistence of antigen is required to maintain tolerance. In Medawar's experiments, the tolerant state was long lived because the injected CBA cells survived and the animals continued to be chimeric (i.e., they possessed both A and CBA cells). With nonliving antigens, such as soluble bovine serum albumin, tolerance is gradually lost because in the absence of antigen, newly recruited immunocompetent cells that are being generated throughout life are not being rendered tolerant. As recruitment of newly competent

T-lymphocytes is drastically curtailed by removal of the thymus, it is of interest to note that the tolerant state persists for much longer in thymectomized animals.

The vital importance of the experiments by Medawar and his team was their demonstration that a state of immunological tolerance can result from exposure to an antigen. As will be discussed in the text, there is a window of susceptibility to clonal deletion of self-reacting T-lymphocytes at an immature phase in their ontogenic development within the thymus (and in the case of B-cells within the bone marrow). Although in animal models it is often easier to impose tolerance during the neonatal period when there is extensive production of naive lymphocytes, tolerance can be induced throughout life. Note that naive T-cells are generally more readily tolerizable than memory cells.

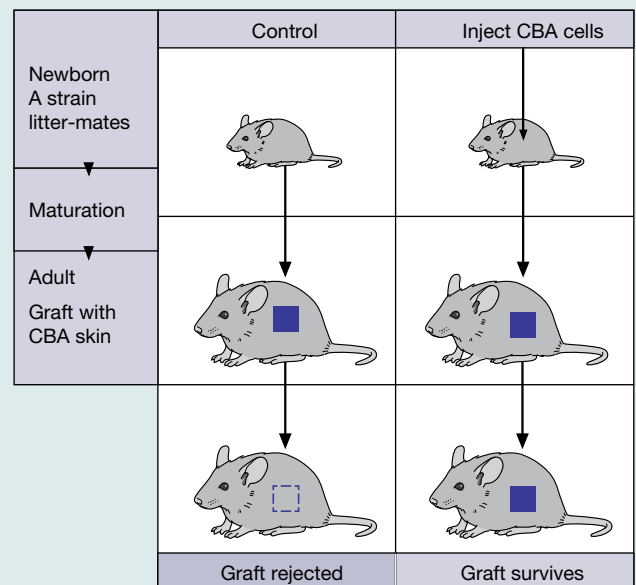


Figure M10.2.1 Induction of tolerance to foreign CBA skin graft in A strain mice by neonatal injection of antigen. The effect is antigen specific as the tolerant mice can reject third-party grafts normally. (Source: Billingham R. *et al.* (1953) *Nature* **172**, 603–606. Reproduced with permission of Nature Publishing Group.)

Table 10.3 Induction of tolerance in bone marrow stem cells by incubation with deoxyguanosine (dGuo)-sensitive macrophages or dendritic cells in the thymus. Clearly, the bone marrow cells induce tolerance to their own haplotype. Thus the thymic tolerance-inducing cells can be replaced by progenitors in the bone marrow inoculum (Jenkinson E.J. *et al.* (1985) *Transplantation* **39**, 331) or by adult dendritic cells from spleen, showing that it is the stage of differentiation of the immature T-cell rather than any special nature of the thymic antigen-presenting cell which leads to tolerance (Matzinger P. and Guerder S. (1989) *Nature* **338**, 74).

Bone marrow cells	Incubate with H-2 ^d thymus	Tolerance induction to H-2 haplotype		
		k	d	b
k	Untreated	+	+	-
k	dGuo-treated	+	-	-
k+d	dGuo-treated	+	+	-

reasonable expectation. If stem cells in bone marrow of H-2^k haplotype are cultured with fetal thymus of H-2^d origin, the maturing cells become tolerant to H-2^d, as shown by their inability to give a mixed lymphocyte proliferative response when cultured with stimulators of H-2^d phenotype; third-party responsiveness is not affected. Further experiments with deoxyguanosine-treated thymuses showed that the cells responsible for tolerance induction were deoxyguanosine-sensitive, bone marrow-derived macrophages or dendritic cells that are abundant at the corticomedullary junction (Table 10.3).

Intrathymic clonal deletion leads to self-tolerance

There seems little doubt that strongly self-reactive T-cells can be physically deleted within the thymus. If we look at the experiment in Table 10.2b, we can see that SCID males bearing the rearranged transgenes coding for the $\alpha\beta$ receptor reacting with the male H-Y antigen do not possess any immunocompetent thymic cells expressing this receptor, whereas the females that lack H-Y do. Thus, when the developing T-cells react with self antigen in the thymus, they are deleted. In other words, self-reactive cells undergo a *negative selection* process in the thymus, a process that constitutes *central tolerance* of the T-cells. Expression of the **AIRE** (*autoimmune regulator*) gene in medullary thymic epithelial cells acts as a master switch directing the transcriptional activation of the genes for a number of organ-specific self antigens (i.e., genes that would only otherwise be expressed in their respective organs). The ectopic expression of these antigens provokes the elimination of the corresponding self-reactive thymocytes. Confirmation of the importance of *AIRE* expression for such clonal deletion came from experiments using a double transgenic model developed

by Goodnow and colleagues. In these mice a membrane-bound version of hen egg lysozyme (HEL) is transgenically expressed as a “neo-self” antigen (because this “foreign” antigen is always present it becomes essentially a self antigen), and high numbers of thymocytes specific for this antigen are also generated by introduction of the relevant TCR as the other transgene. When the HEL transgene is linked to the tissue-specific rat insulin promoter (RIP), expression of the “self” antigen occurs in both the β -cells in the islets of Langerhans of the pancreas **and** in the thymus. In the absence of AIRE the RIP-driven expression of HEL fails to occur in thymic epithelium, but still occurs in the pancreatic islets. The developing transgenic T-cells that are normally deleted in the thymus escape deletion in the *Aire*-deficient mice and kill the β -cells in the pancreas (Figure 10.6).

Deletion of thymocytes also occurs when thymic cells bear certain self-components that act as superantigens, in this case because the antigen reacts with a whole family of V β receptors through recognition of nonvariable structures on a V β segment. For example, mice of the *Mls^l* genotype delete V β 6-bearing cells, the *Mls* being a locus encoding a B-cell superantigen that induces strong proliferation in V β 6 T-cells from a strain bearing a different *Mls* allele. Even exogenous superantigens, such as staphylococcal enterotoxin B that activates the V β 3 and V β 8 T-cell families in the adult, can induce apoptosis in early immature thymocytes utilizing these receptor families.

Factors affecting positive or negative selection in the thymus

T-cells that either fail to express a TCR at all, or which express a TCR of very low affinity, do not receive survival signals and die from neglect. For the remaining cells the engagement of the TCR by MHC-peptide underlies both positive and negative selection. But how can the same MHC-peptide signal have two totally different outcomes? Well, positive and negative selection may occur at low and high degrees of TCR ligation, respectively. For example, high concentrations of antibody to the TCR-associated CD3 induce apoptosis in thymocytes, whereas low concentrations do not. Furthermore, many examples have been published showing that the same peptide will induce positive selection at low concentration and negative selection at high concentration. This has led to the avidity model, which postulates that no interaction or a very low avidity interaction between T-cell and peptide-MHC will lead to death by neglect, a low/intermediate-avidity interaction will positively select double-positive CD4⁺CD8⁺ thymocytes, while a high-avidity interaction will lead to clonal deletion. Thus, engagement of the TCR with self MHC on cortical epithelial cells leads to expansion and positive selection for clones that recognize self MHC, perhaps with a whole range of affinities, but that engagement of the TCR with high affinity for self MHC (+ self peptide) on medullary epithelial cells and dendritic cells will lead to elimination and hence negative selection. Let us finish on a cautionary note: the avidity model may be substantially correct but it could be an oversimplification. For instance, certain superantigens that

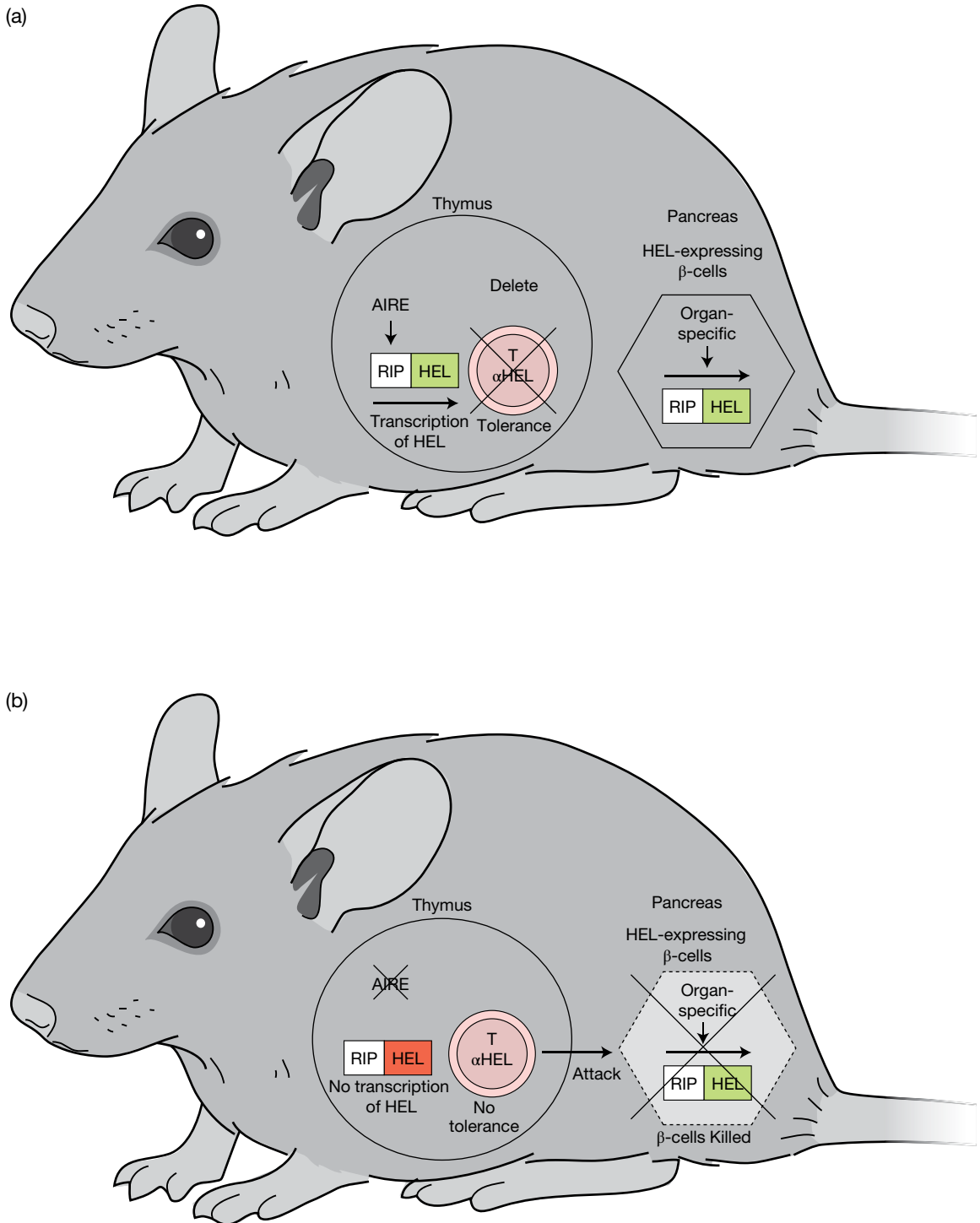


Figure 10.6 AIRE directs the ectopic expression of organ-specific self antigens in the thymus. Double transgenic mice were generated by crossing transgenic mice expressing a membrane-bound form of hen egg lysozyme (HEL) under the control of the rat insulin promoter (RIP) with mice expressing the transgenic 3A9 $\alpha\beta$ TCR specific for the amino acid 46–61 peptide from HEL presented by the I-A^k MHC class II molecule. These mice normally tolerize the transgenic T-cells in the thymus (a), but this did not occur if the mice were backcrossed to mice in which the AIRE gene had been knocked out (b). The incidence of type 1 diabetes was dramatically increased in the absence of AIRE expression. (Data source: Liston A. *et al.* (2004) *Journal of Experimental Medicine* **200**, 1015–1026.)

can cause clonal deletion of certain V β families fail to expand them even at very low concentrations when the model would have indicated positive selection. This finding has spawned other models involving conformational changes at the TCR–peptide–MHC binding interface. Given the complex interactions of peptides behaving as agonists, partial agonists, and antagonists it is likely that the last word has not yet been spoken (not that it ever is in science!).

T-cell tolerance can also be due to clonal anergy

We have already entertained the idea that engagement of the TCR plus a co-stimulatory signal from an antigen-presenting cell are both required for T-cell stimulation, but, when the co-stimulatory signal is lacking, the T-cell becomes anergic. T-cell tolerance occurring outside the thymus is referred to as *peripheral tolerance*. Thus, anergy can be induced in T-cells by peripheral antigens *in vivo* when presented by cells lacking co-stimulatory molecules. The anergic T-cells are unable to produce IL-2, even if subsequently given signals through their TCR with concomitant co-stimulation by cross-linking CD28 on their cell surface. In some experimental models, anergy can be broken by providing high levels of exogenous IL-2 (i.e., anergy is a potentially reversible tolerance whereas clonal deletion by apoptosis clearly is not, as the deleted cells no longer exist).

Lack of communication can cause unresponsiveness

It takes two to tango: if the self molecule cannot engage the TCR, there can be no response. The anatomical isolation of molecules, like the lens protein of the eye and myelin basic protein in the brain, virtually precludes them from contact with lymphocytes, except perhaps for minute amounts of breakdown metabolic products that leak out and may be taken up by antigen-presenting cells, but at concentrations way below that required to trigger the corresponding naive T-cell.

Even when a tissue is exposed to circulating lymphocytes, the concentration of processed peptide on the cell surface may be insufficient to attract attention from a potentially autoreactive cell in the absence of co-stimulatory B7. This situation was demonstrated rather elegantly in animals bearing two transgenes: one for the TCR of a CD8 cytotoxic T-cell specific for lymphocytic choriomeningitis (LCM) virus glycoprotein, and the other for the glycoprotein itself expressed on pancreatic β -cells through the insulin promoter. The result? A deafening silence: the T-cells were not deleted or tolerized, nor were the β -cells attacked. If these mice were then infected with LCM virus, the naive transgenic T-cells were presented with adequate concentrations of the processed glycoprotein within the adjuvant context of a true infection and were now stimulated. Their primed progeny, having an increased avidity and thereby being able to recognize the low concentrations of processed glycoprotein on the β -cells, attacked their targets even in the absence of B7 and caused diabetes (Figure 10.7). This may sound a trifle tortuous, but the principle could have important implications for the induction of autoimmunity by cross-reacting T-cell epitopes.

Molecules that are specifically restricted to particular organs that do not normally express MHC class II represent another special case, as they would not have the opportunity to interact with organ-specific CD4 T-helper cells.

Immunological silence would also result if an individual has no genes coding for lymphocyte receptors directed against particular self-determinants; analysis of the experimentally induced autoantibody response to cytochrome *c* suggests that only those parts of the molecule that show species variation are autoantigenic, whereas the highly conserved regions where the genes have not altered for a much longer time appear to be silent, supposedly because the autoreactive specificities have had time to disappear during evolution.

B-cells differentiate in the fetal liver and then in bone marrow

A series of differentiation markers are associated with B-cell maturation (Figure 10.8). The B-lymphocyte precursors, pro-B-cells, are present among the islands of hematopoietic cells in fetal liver by 8–9 weeks of gestation in humans and 14 days in the mouse. Production of B-cells wanes in neonatal

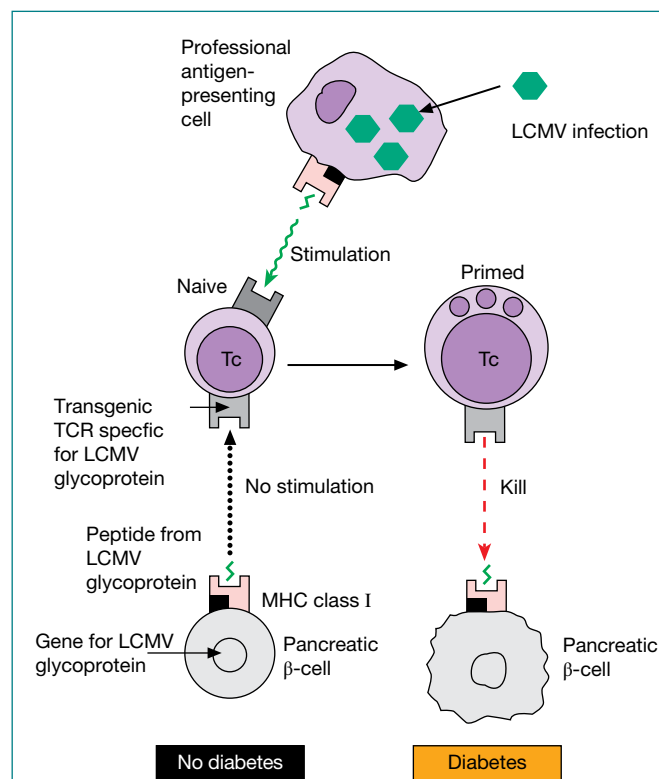


Figure 10.7 Mutual unawareness of a naive cytotoxic precursor T-cell and its B7-negative cellular target bearing epitopes present at low concentrations. Priming of the naive cell by a natural infection and subsequent attack by the higher avidity primed cells on the target tissue. LCMV, lymphocytic choriomeningitis virus. (Source: Ohashi P.S. *et al.* (1991) *Cell* **65**, 305–317. Reproduced with permission of Elsevier.)

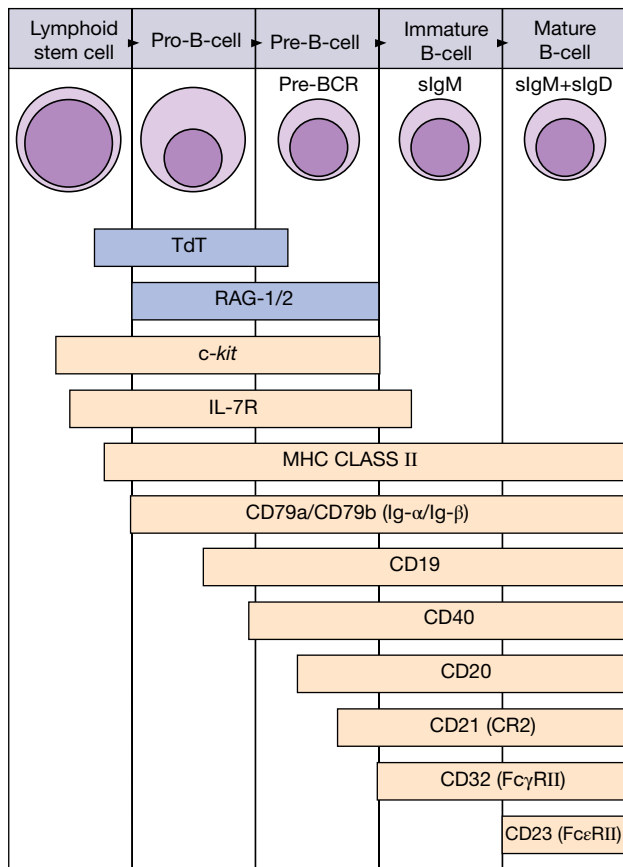


Figure 10.8 Some of the differentiation markers of developing B-cells. The time of appearance of enzymes involved in Ig gene rearrangement and diversification (blue boxes) and of surface markers defined by monoclonal antibodies (orange boxes, see Table 10.1 for list of CD members) is shown.

liver and is mostly taken over by the bone marrow for the remainder of life. Bone marrow stromal reticular cells, which express adhesion molecules and secrete IL-7, extend long dendritic processes making intimate contact with IL-7 receptor-positive B-cell progenitors.

Pax5 is a major determining factor in B-cell differentiation

Development of hematopoietic cells along the B-cell lineage requires expression of E2A and of early B-cell factor (EBF); the absence of either of these prevents pro-B-cells progressing to the pre-B-cell stage (Figure 10.9). Also required is expression of the *Pax5* gene that encodes the BSAP (B-cell-specific activator protein) transcription factor. Thus, in *Pax5*^{-/-} knockout mice, early pre-B-cells (containing partially rearranged immunoglobulin heavy chain genes) fail to differentiate into mature, surface Ig⁺ B-cells (Figure 10.9). However, if the pre-B-cells from *Pax5*^{-/-} knockout mice are provided with the appropriate cytokines *in vitro*, they can be driven to produce T-cells, NK cells, macrophages, dendritic cells, granulocytes, and even

osteoclasts! These unexpected findings clearly demonstrated that the early pre-B-cell has the potential to be diverted from its chosen path and instead provide a source of cells for many other lineages. However, these pre-B-cells are not as multipotential as the bone marrow hematopoietic stem cells and they are unable to rescue lethally irradiated mice. It is clear that *Pax5* acts as a critical master gene by directing B-cell development along the correct pathway, and does this by repressing expression of genes, such as those encoding Notch-1, myeloperoxidase, and monocyte/macrophage colony-stimulating factor receptor, that are associated with other lineages, while activating B-cell-specific genes including Ig-α, CD19, and the adaptor protein BLNK.

B-1 and B-2 cells represent two distinct populations

There exists a subpopulation of B-cells (referred to as **B-1 cells**) that, in addition to surface IgM, express CD5. They produce the so-called “natural antibodies” that provide a pre-existing first line of IgM defense against common microbes. The progenitors of the B-1 cells move from the fetal liver to the peritoneal cavity fairly early in life. The **B-1 cell phenotype – high surface IgM, low surface IgD, CD43⁺, and CD23⁻** – is shared by a minority subpopulation that is, however, CD5⁺; these two populations are referred to as B-1a and B-1b, respectively (Figure 10.10). Conventional B-cells (**B-2 cells**), have the **phenotype low surface IgM, high surface IgD, CD5⁻, CD43⁻, and CD23⁺**.

At least in mice, B-1a, B-1b, and B-2 cells are each derived from distinct progenitors. Although B-1 cells can shift to a B-2 phenotype, and possibly vice versa, there is minimal conversion between the two lineages under normal circumstances. B-1 cells are particularly prevalent in the peritoneal and pleural cavities, and maintain their numbers by self-replenishment. A major factor influencing self-renewal could be the constitutive production of IL-10, as treatment of mice with anti-IL-10 from birth virtually wipes out the B-1 subset. The predisposition for self-renewal may underlie their undue susceptibility to become leukemic, with the malignant cells in chronic lymphocytic leukemia being almost invariably CD5⁺.

B-1 cells tend to use particular germline *V* genes and respond to type 2 thymus-independent antigens. Furthermore, they may be involved in the generation of idiotype networks concerned in self-tolerance, and in the response to conserved microbial antigens.

Development of B-cell specificity

The sequence of immunoglobulin gene rearrangements

There is an orderly sequence of Ig gene rearrangements during early B-cell differentiation (Figure 10.11):

- **Stage 1:** Initially, the *D–J* segments on both alleles of the Ig **heavy** chain gene loci (one from each parent) rearrange so

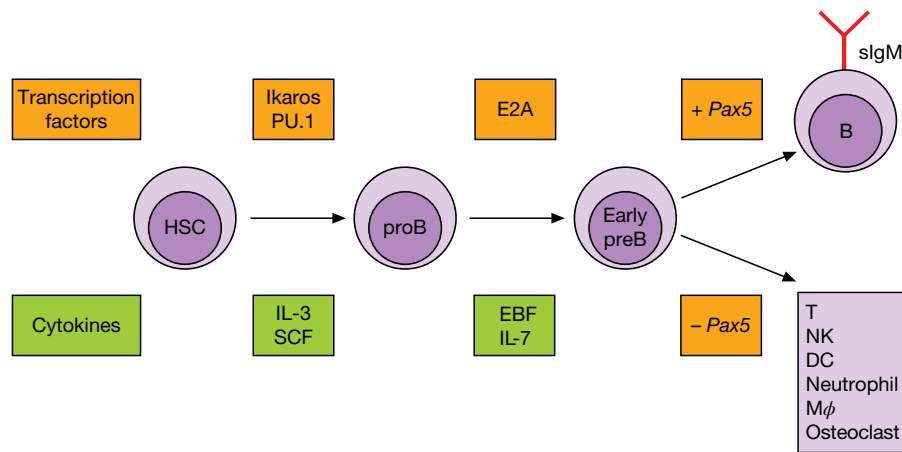


Figure 10.9 *Pax5* is required for B-cell differentiation. Hematopoietic stem cells (HSC) under the influence of stem cell factor (SCF), IL-3 and the Ikaros and PU.1 transcription factors can differentiate into pro-B-cells. Further differentiation into pre-B-cells requires the E2A transcription factor together with early B-cell factor (EBF) and IL-7. Homozygous E2A mutant mice lack pre-B-cells, there being a block to D_H-J_H rearrangement in the Ig heavy chain locus plus severe reduction in RAG-1, Ig- α , CD19, and $\lambda 5$ transcripts. If at the early pre-B stage *Pax5* is not expressed, then differentiation along the B-cell lineage pathway comes to an abrupt halt. These early pre-B-cells have rearranged Ig D_H to J_H indicating their intention to become B-cells. However, even at this late stage, they can make other lineage choices as evidenced by the fact that, in the absence of *Pax5* expression, they can give rise to a number of other cell types if they are provided with appropriate cytokines. Indeed, *Pax5*^{-/-} clones are able to develop into T-cells if transferred to immunodeficient mice, in which case they express rearranged TCR genes in addition to their initial Ig heavy chain gene rearrangement.

that one *D* segment is placed next to one *J* segment. The random nature of this rearrangement process will usually result in the *DJ* combination on one allele being different to that on the other allele.

- **Stage 2:** A *V-DJ* recombinational event now occurs on just one of the two **heavy** chain alleles, whereby a randomly picked *V* segment is placed next to the already recombined *DJ* segment. If this proves to be a **nonproductive** rearrangement (i.e., adjacent segments are joined in an incorrect reading frame or in such a way as to generate a termination codon downstream from the splice point), then a second *V-DJ* rearrangement will occur on the sister heavy chain locus. If a productive rearrangement is not achieved, we can wave the pre-B-cell a fond farewell.
- **Stage 3:** If a productive rearrangement is made, the *VDJ* segment in the pre-B-cell utilizes the heavy chain constant (C_H) region $C\mu$ gene to synthesize μ heavy chains. At around the same time, two genes, **VpreB** (*CD179a*) and $\lambda 5$ (*CD179b*), with homology for the V_L and C_L segments of λ light chains respectively, are temporarily transcribed to form a **surrogate light chain** that associates with the conventional μ heavy chains to generate a surface surrogate “IgM” receptor, together with the Ig- α (*CD79a*) and Ig- β (*CD79b*) chains required to initiate signaling into the B-cell. This surrogate receptor closely parallels the pre-T α/β receptor on pre-T-cell precursors of $\alpha\beta$ TCR-bearing cells.
- **Stage 4:** The surface receptor becomes cross-linked, possibly by interaction of $\lambda 5$ with galactin-1 on bone marrow

stromal cells. This results in signaling by the pre-B-cell receptor through Ig- α/β , and subsequent **allelic exclusion** whereby there is suppression of any further rearrangement of heavy chain genes on a sister chromatid.

- **Stage 5:** Expression of the interferon regulatory factors IRF-4 and IRF-8 downregulates the production of VpreB and $\lambda 5$ and induces rearrangement of the conventional light chain genes. This involves *V-J* recombinations on first one and then the other **light chain** allele until a productive *Vk-J* rearrangement is accomplished. If this fails, an attempt is made to achieve productive rearrangement of the λ **light chain** alleles. Subsequent expression of a productively rearranged k or λ light chain permits synthesis of conventional **surface IgM**.
 - **Stage 6:** The surface IgM molecule prohibits any further gene shuffling by allelic exclusion of any non-rearranged light chain genes. Surface IgD bearing an identical VDJ sequence to the IgM heavy chain is produced by alternative splicing of the heavy chain RNA transcript and the naive IgM⁺IgD⁺ B-cell is now ready for its encounter with antigen.
- Upon antigenic stimulation IgD is lost and, in the presence of appropriate T-cell help, **class switching** of B-2 cells from IgM to **IgG**, **IgA**, or **IgE** antibody production can occur together with somatic hypermutation of *V(D)J* genes and selection of higher affinity clones. Following of differentiation of the B-cell into a plasma cell, virtually all surface Ig is lost as a result of the cell converting from producing the transmembrane version of antibody to the soluble (secreted) form.

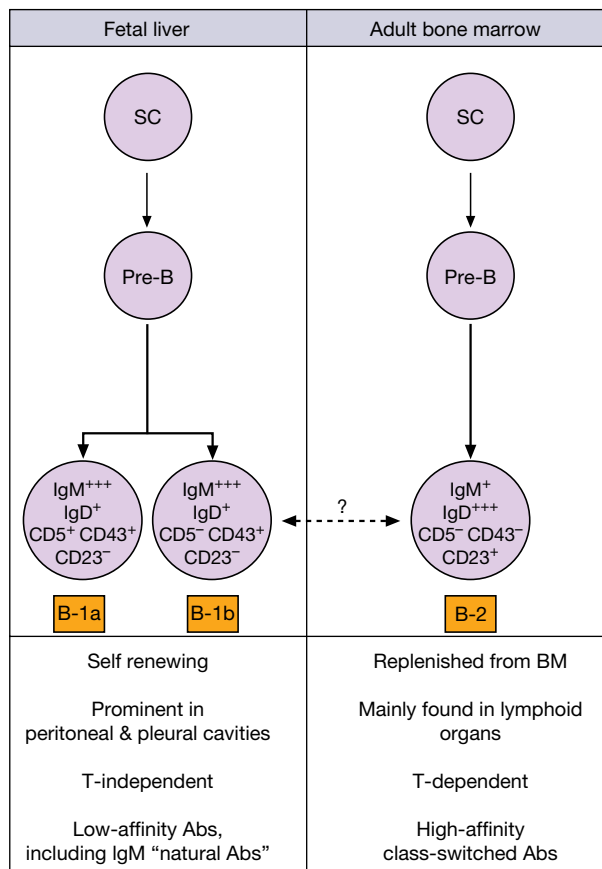


Figure 10.10 The development of separate B-cell subpopulations. B-1 cells particularly produce IgM lower affinity “natural antibody.” By contrast, B-2 cells give rise to the higher affinity IgG antibody produced by helper T-cell-dependent class-switched B-cells, which undergo V(D)J somatic hypermutation and subsequent antigen selection. It is thought that, although these subsets might be able to give rise to each other under some circumstances, generally they are maintained as separate lineages.

Allelic exclusion

As each cell has chromosomes derived from both parents, the differentiating B-cell has four light (two kappa, two lambda) and two heavy chain gene clusters to choose from. We have described how, once the *VDJ* DNA rearrangement has occurred within one heavy and *VJ* rearrangement in one light chain cluster, the *V* genes on the other four chromosomes are held in the germline (i.e., inherited) state by an allelic exclusion mechanism so that the cell is able to express only one heavy and one light chain. This is essential for clonal selection to work as the cell is then only programmed to make the one antibody it uses as its cell surface receptor for antigen. Furthermore, this gene exclusion mechanism prevents the formation of molecules containing two different light or two different heavy chains that would have non-identical combining sites and therefore be functionally monovalent with respect to the majority of

antigens; such antibodies would be non-agglutinating and would tend to have low avidity as the bonus effect of multivalency could not operate.

B-cell tolerance

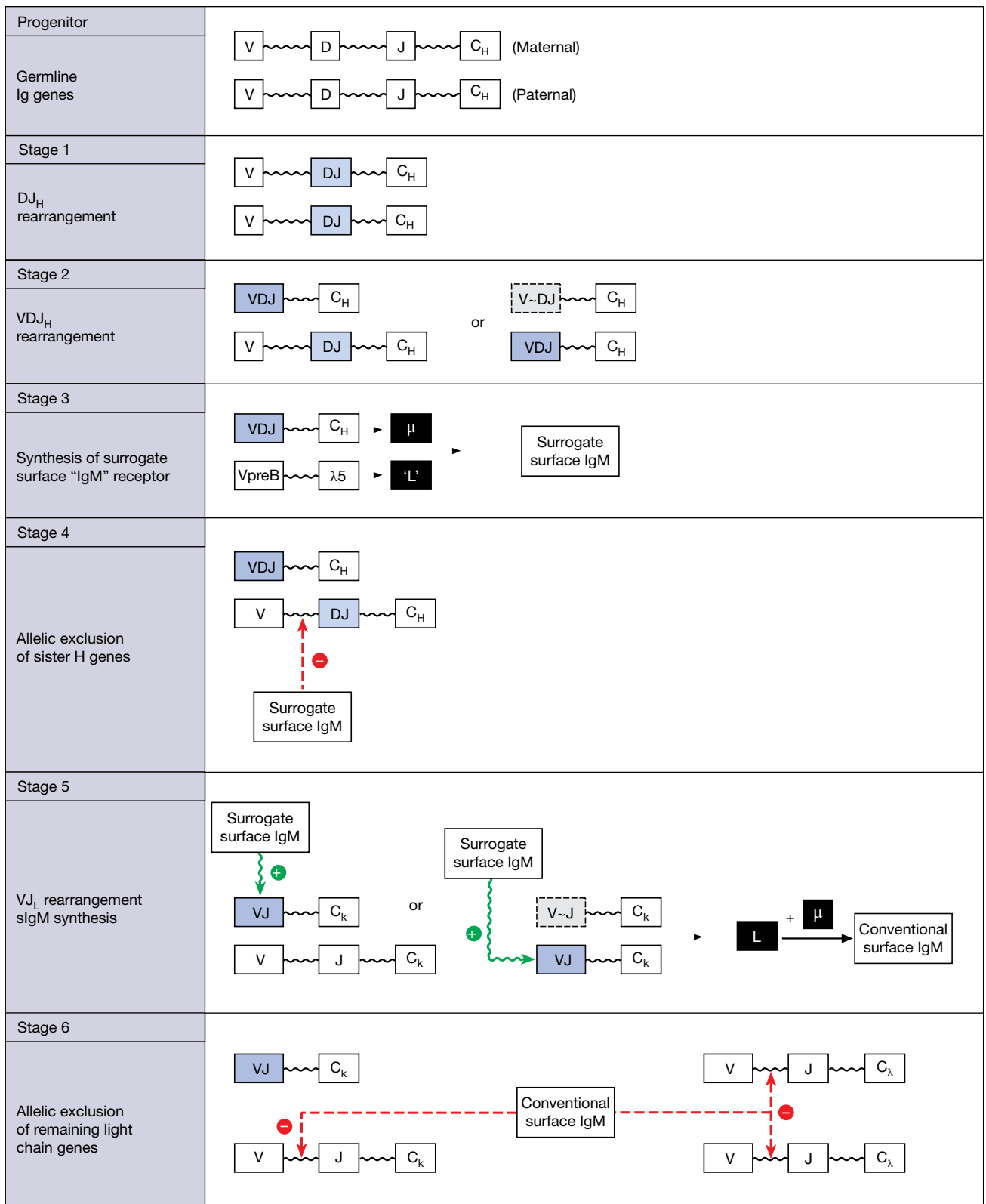
Clonal deletion and clonal anergy

Just as for T-cells, both deletion and anergy can operate on B-cells to prevent responsiveness to self. Excellent evidence for deletion comes from mice bearing transgenes coding for IgM, which binds to H-2K molecules of all *H-2* haplotypes except *d* and *f*. Mice of *H-2^d* haplotype express the transgenic IgM abundantly in the serum, whereas 25–50% of total B-cells bear the transgenic antibody. It was found that *d* × *k*F1 crosses completely failed to express the transgene (i.e., B-cells programmed for anti-H-2K^k were expressed in *H-2^d* mice but deleted in mice positive for H-2K^k that in these circumstances acts as an autoantigen).

Tolerance through B-cell anergy was clearly demonstrated in another study in which double transgenic mice were made to express both soluble lysozyme and a high-affinity antibody to lysozyme. The animals were completely tolerant and could not be immunized to make anti-lysozyme; nor did the transgenic antibody appear in the serum although it was abundantly present on the surface of B-cells. These anergic cells could bind antigen to their surface receptors but could not be activated. These tolerized lymphocytes therefore can “see” the antigen but lack the ability to respond.

Whether deletion or anergy is the outcome of the encounter with self probably depends upon the concentration and ability to cross-link Ig receptors. In the first of the two B-cell tolerance models above, the H-2K^k autoantigen would be richly expressed on cells in contact with the developing B-lymphocytes and could effectively cause cross-linking. In the second case, the lysozyme, masquerading as a “self”-molecule, is essentially univalent with respect to the receptors on an anti-lysozyme B-cell and would not readily bring about cross-linking. The hypothesis was tested by stitching a transmembrane hydrophobic segment onto the lysozyme transgene so that the antigen would be multiply inserted into the cell membrane. Result? B-cells expressing the high-affinity anti-lysozyme transgene were eliminated.

Another self-censoring mechanism, receptor editing, can also come into play. We have already discussed one type of receptor editing in which secondary rearrangements substitute another *V* gene onto an already rearranged *V(D)J* segment. However, receptor editing can also occur by wholesale replacement of an entire light chain. This can best be explained by an example. If the heavy and light chain Ig genes encoding a high-affinity anti-DNA autoantibody are introduced as transgenes into a mouse, a variety of light chains are produced by genetic reshuffling until a combination with the heavy chain is achieved that no longer has anti-DNA activity (i.e., the autoreactivity is edited out). This will often involve replacement of a *k* light chain with a new rearrangement made



VDJ = productive rearrangement; **V~DJ** = nonproductive rearrangement

Figure 10.11 Sequence of B-cell gene rearrangements and allelic exclusion.

on the λ light chain locus and is associated with re-expression of the *RAG-1/2* genes.

Once peripheralized, the bulk of the B-cell pool is stable; lymph node B-cells (and T-cells) from unprimed mice survived comfortably for at least 20 months on transfer to H-2 identical SCID animals.

Tolerance can also result from a lack of T-cell help

With soluble proteins at least, T-cells are more readily tolerized than B-cells (Figure 10.12) and, depending upon the circulating protein concentration, a number of self-reacting B-cells may be present in the body that cannot be triggered by T-dependent self-components as the T-cells required to provide the necessary T–B help are already tolerant – you might describe the B-cells as helpless. If we think of the determinant on a self-component that combines with the receptors on a self-reacting B-cell as a hapten and another determinant that has to be recognized by a T-cell as a carrier (cf. Figure 7.23), then tolerance in the T-cell to the carrier will prevent the provision of T-cell help and the B-cell will be unresponsive. Take C5 as an example; this is normally circulating at concentrations that tolerize T- but not B-cells. Some strains of mice are congenitally deficient in C5 and their T-cells can help C5-positive strains to make antibodies to C5 (i.e., the C5-positive strains still have inducible B-cells but they are helpless and need non-tolerized T-cells from the C5-negative strain) (Figure 10.13).

It is worth noting the observation that injection of high doses of a soluble antigen without adjuvant, even when given several days after primary immunization with that antigen, prevented the emergence of high-affinity mutated antibodies.

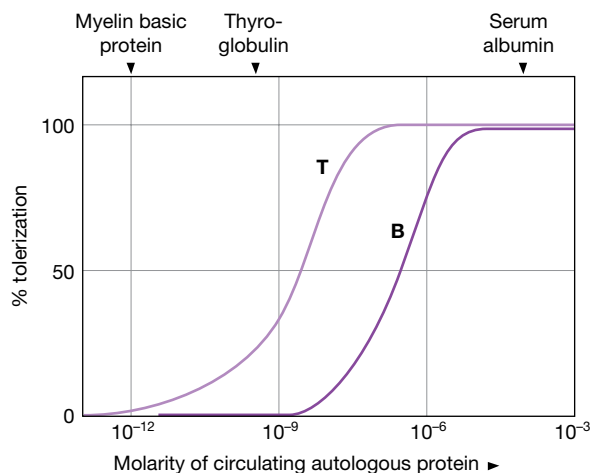


Figure 10.12 Relative susceptibility of T- and B-cells to tolerance by circulating self antigens. Self antigens circulating at low concentration induce no tolerance; at intermediate concentration (e.g., thyroglobulin), T-cells are moderately tolerized; molecules such as albumin, which circulate at high concentrations tolerize both B- and T-cells.

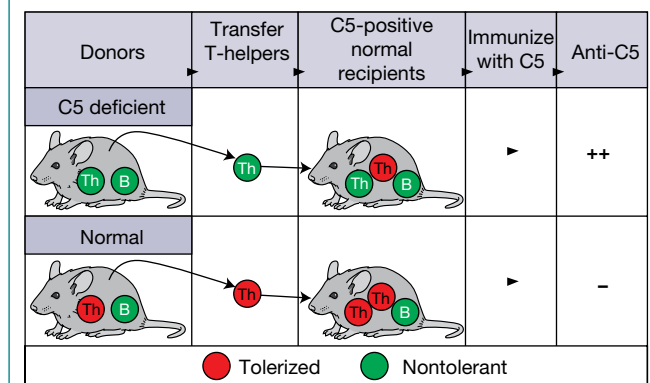


Figure 10.13 Circulating C5 tolerizes T-cells but not B-cells, leaving them helpless. Animals with congenital C5 deficiency do not tolerize their T-helpers and can be used to break tolerance in normal mice.

Transfer experiments showed the T-cells to be tolerant. This tells us that, even when an immune response is well underway, T-helpers in the germinal center are needed to permit the mutations that lead to affinity maturation of antibody.

Remember that, throughout the life of an animal, new hematopoietic stem cells are continually differentiating into immunocompetent lymphocytes and what is early in ontogeny for them can be late for the host; this means that self-tolerance mechanisms are still acting on early lymphocytes even in the adult. The various mechanisms that have been discussed above are summarized in Figure 10.14.

Lymphocytes go through antigen-independent and antigen-dependent stages of differentiation

Before the expression of antigen-specific receptors on their cell surface, the development of both T- and B-lymphocytes is, by definition, antigen independent. As they develop, the precursors of $\alpha\beta$ T-cells and B-cells will begin to express a “pseudo” antigen receptor (utilizing pre-T α or VpreB λ 5, respectively) but this is not itself specific for antigen. It is only following recombination and expression of the genes for both chains of the conventional receptor (Ig H+L, TCR $\alpha\beta$ or TCR $\gamma\delta$) that the lymphocytes are able to recognize and respond to specific antigen. Initially most antigens that will be encountered are self antigens, including the MHC molecules that are so critical for thymic education of the T-cells. Once they leave the primary lymphoid tissues further differentiation is dependent upon antigen-specific stimulation of the lymphocytes in the secondary lymphoid tissues (Figure 10.15).

Natural killer (NK) cell ontogeny

Natural killer cells differentiate from common lymphoid progenitors in the bone marrow. NK precursors can either remain in the bone marrow or seed to lymph nodes, liver, or thymus.

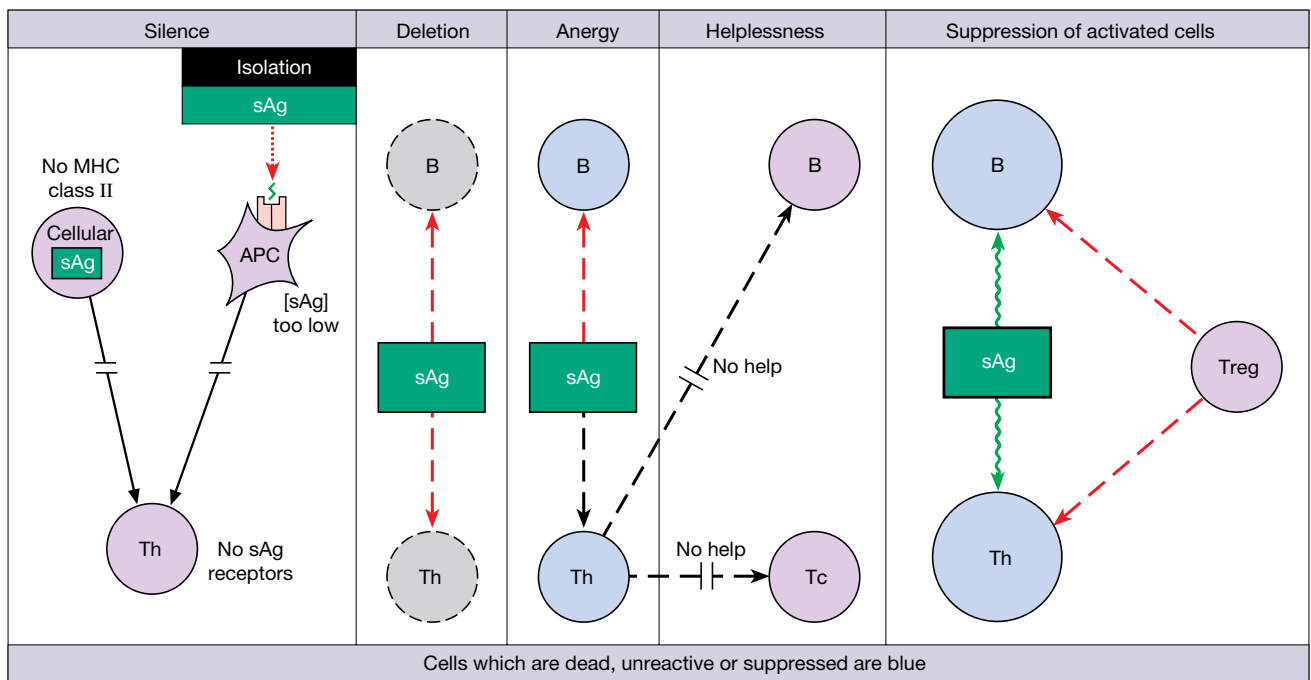


Figure 10.14 Mechanisms of self-tolerance (see text). sAg, self antigen; APC, antigen-presenting cell; Th, T-helper; Treg, regulatory T-cell; Tc, cytotoxic T-cell precursor.

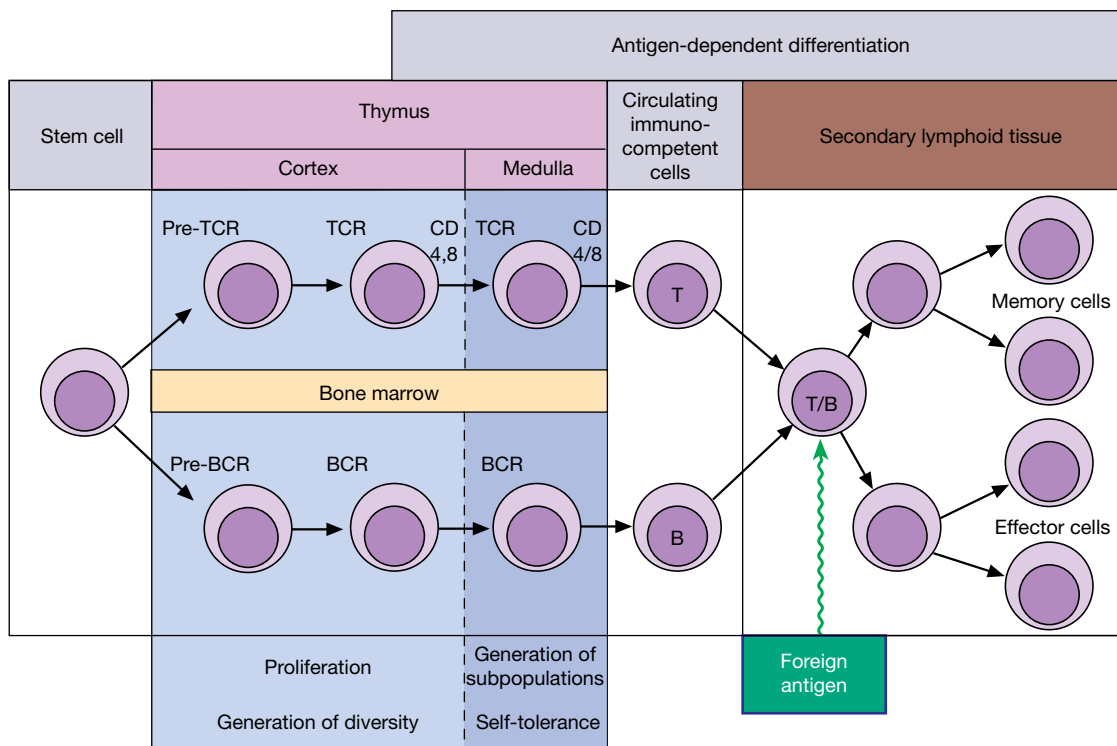


Figure 10.15 Antigen-independent and antigen-dependent differentiation of T- and B-cells. Initial differentiation of both T-cell and B-cell precursors is independent of antigen until the antigen receptor genes are recombined and expressed. Following expression of a TCR the cortical thymocytes become “double positive” for CD4 and CD8. Positive selection for recognition of self MHC haplotype occurs in the cortex, and subsequently negative selection occurs in the medulla with the loss of expression of either CD4 or CD8 as the lymphocytes become “single positive” T-cells. B-cells undergo recombination of immunoglobulin genes in the bone marrow and selection events, still rather poorly characterized, occur in this location. The T-cells and B-cells leave the primary lymphoid tissues as immunocompetent cells and seed to the secondary lymphoid tissues where they can become activated by foreign antigen resulting in the generation of effector and memory lymphocytes.

The precursors in these locations are stimulated to proliferate and differentiate by various cytokines, with IL-15 being of particular importance. At the early stages of their differentiation they lack many of the markers of mature NK cells such as CD16 (Fc γ RIII) and the NK inhibitory and stimulatory receptors. Upon expression of inhibitory receptors and their subsequent engagement by self MHC molecules, a process referred to as “education” or “licensing” of NK cells occurs that is critical for their development into mature fully functional NK cells (Figure 10.16). The mature NK cells can then relocate from the bone marrow, lymph nodes, liver, or thymus to other locations in the body, including mucosal tissues such as the respiratory tract, GI tract, and uterus.

Neonatal immunity

The uterus constitutes a relatively sterile environment but from the time of birth onwards the infant is fully exposed to the potentially hostile microbial world. A vast array of microbes colonize the body, collectively constituting the microbiota, most of which are harmless commensals but which might have lurking among them some potentially pathogenic organisms. Early immune responses are shaped by the composition of the microbiota together with the genetics and diet of the individual.

It is the innate response that will usually play the predominant role in the newborn. This will include recognition of pathogens by the pattern recognition receptors on phagocytic cells, along with the potential involvement of NK cells, invariant NKT cells, $\gamma\delta$ T-cells and B-1 B-cells. Conventional (B-2) B-cell responses along with helper, cytotoxic, and regulatory T-cell responses are relatively immature at the time of birth, and overall there is a skewing towards Th2 responses in the newborn. Furthermore, lymph node and spleen remain relatively underdeveloped in the human at the time of birth, except where there has been intrauterine exposure to antigens as in congenital infections with rubella or other organisms.

Although the ability to reject grafts and to mount an antibody response is partially developed by birth, the immune system is still relatively immature and therefore not fully immunocompetent. Immunoglobulin levels, with one exception, are low, particularly in the absence of intrauterine infection. The exception is the IgG acquired by placental transfer from the mother using the neonatal Fc receptor, FcRn. The combination of immune immaturity and the presence of potentially “blocking” maternal antibodies that might limit access of antigen to the B-cell receptors could compromise the generation of immunological memory to natural infections and to vaccines in the newborn. However, the maternal IgG is catabolized with a half-life of approximately 3 weeks and there

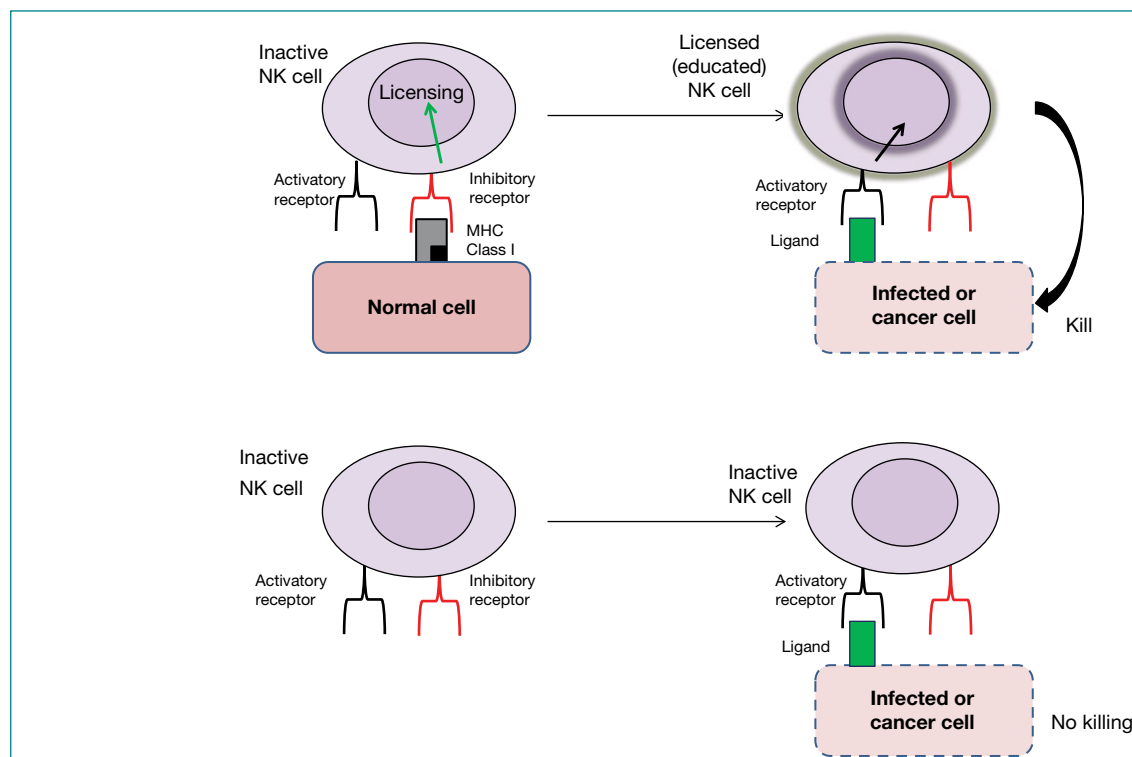


Figure 10.16 Licensing of NK cells. Natural killer cells possess both activatory and inhibitory receptors. Rather paradoxically during their early development they require signals delivered through their inhibitory receptors in order to ensure their survival and to acquire increased responsiveness to signals delivered through their activatory receptors. They are subsequently able to kill target cells that have lost expression of MHC class I molecules. Unlicensed (uneducated) NK cells are not able to kill such targets.

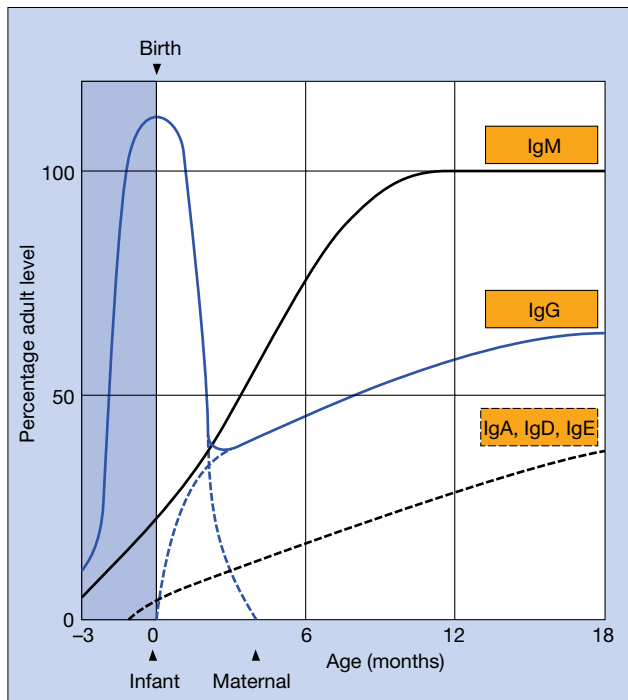


Figure 10.17 Development of serum immunoglobulin levels in the human. (Adapted from Hobbs J.R. (1969) In *Immunology and Development* (ed. M. Adinolfi). Heinemann, London, p. 118.)

is therefore a fall in IgG concentration over the first couple of months, accentuated by the increase in blood volume of the growing infant. Thereafter, the rate of IgG synthesis by the newborn's own B-cells overtakes the rate of breakdown of maternal IgG and the overall concentration increases steadily. The other immunoglobulins do not cross the placenta and the low but significant levels of IgM in cord blood are synthesized by the baby (Figure 10.17). IgM reaches adult levels by 9 months of age. Only trace levels of IgA, IgD, and IgE are present in the circulation of the newborn.

PHYLOGENY

The evolution of the immune response

Earliest defenses

Virtually all living organisms have mechanisms that have evolved to protect them against infection. Restriction endonucleases did not arise to make the life of the molecular geneticist easier, they provide protection to the prokaryotes (bacteria and archaea) against infection with bacteriophage viruses by chopping up foreign DNA. Amoeba are single-celled eukaryotes that are able to engulf and subsequently break down particulate matter by phagocytosis, a process that evolved into a defense strategy of importance throughout the animal kingdom (cf. Milestone 1.1). The recognition and subsequent *rejection of*

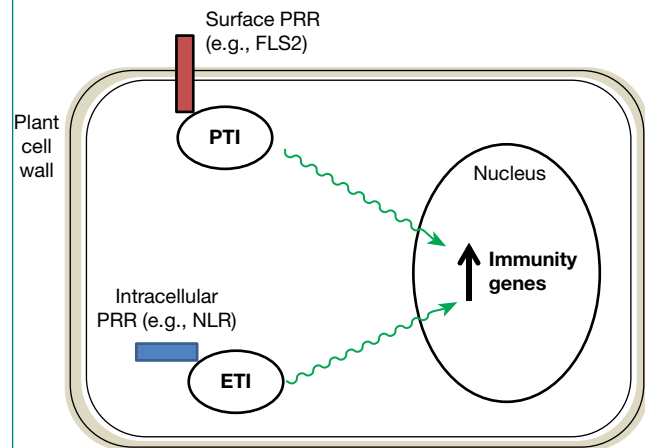


Figure 10.18 Defense against infection in plant cells. The first line of defense is provided by cell surface pattern recognition receptors (e.g., flagellin sensitive 2 [FLS2]) that stimulate PAMP-triggered immunity (PTI). This is backed up by intracellular detection of pathogens provoking effector-triggered immunity (ETI), involving receptors, such as nucleotide-binding leucine-rich repeat (NLR) proteins. Both PTI and ETI lead to the increased expression of immunity genes encoding molecules involved in protection against infection (e.g., defensins).

nonspecific can be identified in invertebrates as far down the evolutionary scale as marine sponges. Thus, parabiosed (placed next to each other) fingers of a marine sponge from the same colony become permanently united but members of different colonies reject each other by 7–9 days.

Defenses against infection in plants

Immune responses in plants have so far only been investigated in a relatively small number of species, and much of the research has focused on the model higher plant *Arabidopsis*, a member of the mustard family, and its response to infection with the bacterium *Pseudomonas syringae*. Nonetheless, it is clear that plants can detect pathogen-associated molecular patterns (PAMPs) using cell surface pattern recognition receptors (PRRs) which initiate a MAP kinase signaling cascade that switches on a respiratory burst to generate reactive oxygen species. Furthermore, activation of a number of immunity genes results in the production of molecules such as defensins with potent antimicrobial activity. One such PRR is FLS2 (flagellin sensitive 2), which detects bacterial flagellin. Because plants lack a mobile defense system, this **PAMP-triggered immunity (PTI)** is a feature of each individual plant cell (Figure 10.18). If pathogens manage to evade PTI responses then a second line of defense, the faster and stronger **effector-triggered immunity (ETI)**, is deployed. These ETI responses depend upon direct or indirect recognition of pathogens within the plant cell by cytoplasmic detectors, such as nucleotide-binding leucine-rich repeat (NLR) proteins encoded by *R* (resistance) genes. ETI results in the generation of some of the

same antimicrobial compounds that are produced during PTI but additionally initiates an *immediate hypersensitive response (HR)* leading to localized apoptosis, thereby rapidly curtailing the growth of the infectious agent. The HR also induces an “immune state” of *systemic acquired resistance (SAR)* that persists for several weeks and extends to a broad range of bacterial, viral, and fungal pathogens beyond the initiating infective agent. A series of SAR genes encode a wide variety of microbicidal proteins that can be induced through endogenous chemical mediators such as salicylic acid, jasmonic acid, and azelaic acid. Quite wonderfully, jasmonic acid also contributes to resistance against herbivorous insects!

Invertebrate microbial defense mechanisms

In many phyla, *phagocytosis* is augmented by coating with *agglutinins* and *bactericidins* capable of binding to PAMPs on the microbial surface so providing the basis for the recognition of “nonself.” It is notable that infection very rapidly induces the synthesis of an impressive battery of *antimicrobial peptides* in higher insects following activation of transcription factors that bind to promoter sequence motifs homologous to regulatory elements involved in the mammalian acute phase response. Thus, the toll molecule in *Drosophila* is a receptor for PAMPs that activate NFκB in these flies. *Drosophila* with a loss-of-function mutation in *toll* is susceptible to fungal infections. Antimicrobial peptides produced by insects include disulfide-bridged cyclic peptides such as the anti-Gram-positive *defensins* and the antifungal peptide *drosomycin*. Linear peptides inducible by infection include the *cecropins* and a series of anti-Gram-negative glycine- or proline-rich polypeptides. Cecropins, which have also been identified in mammals, are strongly cationic peptides with amphipathic α-helices causing lethal disintegration of bacterial membranes by creating ion channels.

Elements of a primordial complement system also exist among the lower orders. A protease inhibitor, a *β₂-macroglobulin* structurally homologous to C3 with an internal thiolester, is present in the horseshoe crab. Conceivably this might represent an ancestral version of C3 that is activated by proteases released at a site of infection, deposited onto the microbe and recognized there as a ligand for the phagocytic cells. The complement receptor CR3 is an integrin, and related integrins in insects may harbor common ancestors. Mention of the horseshoe crab may have stirred a neuronal network in readers with good memories to recall its synthesis of *limulin* (cf. Chapter 1), which is homologous with the mammalian acute phase C-reactive protein (CRP); presumably it acts as a lectin to opsonize bacteria and is likely to be a product of the evolutionary line leading ultimately to C1q, mannose-binding lectin, and lung surfactant protein.

The other major strategy effectively deployed by invertebrates is to wall off an invading microorganism. This is achieved, for example, through proteolytic cascades which produce a coagulum of “gelled” *hemolymph* around the offender.

Adaptive immune responses appear with the vertebrates

Lower vertebrates

The jawless vertebrates, comprising lamprey and hagfish, possess lymphocyte-like cells that express a transmembrane-only variable lymphocyte receptor A (VLRA) on cells that may mediate cellular responses and a VLRA on cells that mediate humoral responses. The latter is also produced as a secreted molecule. Although not members of the immunoglobulin superfamily, the VLRs contain variable and constant regions. They use APOBEC-like cytidine deaminase in a gene conversion mechanism to generate diversity. Genuine adaptive T- and B-responses do not emerge in the phylogenetic tree until we reach the jawed vertebrates.

The BCR–TCR–MHC system arises

The emergence of a thymus in the jawed vertebrates (the cartilaginous fish, bony fish (teleosts), amphibians, reptiles, birds, and mammals) is associated with the presence of MHC molecules. The earliest jawed vertebrates, the cartilaginous fish, have well-defined T- and B-cells and possess recombination-activating genes (RAG) and diversified sets of receptor genes which permit for the first time in evolution the generation of antigen receptors (BCRs and TCRs) created by genetic recombination strategies. They also have immunoglobulins that are composed of both heavy and light chains. It could be argued that we see phylogenetically more ancient, T-independent B-1 (CD5-positive) cells joined by a new T-dependent B-2 population. However, T-dependent high-affinity secondary antibody responses are only seen with warm-blooded vertebrates such as birds and mammals, and these correlate directly with the evolution of germinal centers.

Generation of antibody diversity

Mechanisms for the generation of antibody diversity differ as one goes from one species to another. We are already familiar with the mammalian system where recombinational events involve multiple *V*, *D*, and *J* gene segments. The horned shark also has many *V* genes, but the opportunities for combinatorial joining are tightly constrained by close linkage between individual *V*, *D*, *J*, and *C* segments and this may be a factor in the restricted antibody response of this species. In sharp contrast, there is only one operational *V* gene at the light-chain locus in the chicken, but this undergoes extensive somatic diversification utilizing nonfunctional adjoining *V* pseudogenes in a gene conversion process. Camel lovers should note that not only do they get by on little water but, like the llamas, a proportion of their functional antibodies lack light chains. The especially long CDR3 loop in the heavy chain variable region compensates for the lack of a light chain in these antibodies.

The evolution of distinct B- and T-cell lineages was accompanied by the development of separate sites for differentiation

The differential effects of neonatal bursectomy and thymectomy in the chicken on subsequent humoral and cellular responses paved the way for our eventual recognition of the separate lymphocyte lineages that subserve these functions (Figure 10.19). Like the thymus, the bursa of Fabricius develops as an embryonic outpushing of the gut endoderm, this time from hindgut as distinct from foregut, and provides the microenvironment to cradle incoming stem cells and direct their differentiation to immunocompetent B-lymphocytes. Neonatal bursectomy had a profound effect on overall immunoglobulin levels and on specific antibody production following immunization, but did not unduly influence the cell-mediated delayed-type hypersensitivity (DTH) response to tuberculin or affect graft rejection or graft-versus-host responses. On the other hand, thymectomy grossly impaired cell-mediated reactions and inhibited antibody production to most protein antigens.

The distinctive anatomical location of the B-cell differentiation site in a separate lymphoid organ in the chicken was immensely valuable to progress in this field because it allowed the above types of experiments to be carried out. However, many years went by in a fruitless search for an equivalent bursa in mammals before it was realized that the primary site for B-cell generation was in fact the bone marrow itself.

Cellular recognition molecules exploit the immunoglobulin gene superfamily

When nature fortuitously chanced upon a protein structure (“motif” is the buzzword) that successfully mediates some useful function, the selective forces of evolution make sure that it is widely exploited. Thus, the molecules involved in antigen recognition that we have described in Chapters 3 and 4 are members of the *immunoglobulin gene superfamily* related by sequence and presumably a common ancestry. All polypeptide members of this family, which includes heavy and light Ig chains, T-cell receptor chains, MHC molecules, β_2 -microglobulin, and several hundred other molecules, are composed of one or more immunoglobulin homology units. Each *immunoglobulin-type domain* is roughly 110 amino acids in length and is characterized by certain conserved residues around the two cysteines found in each domain and the alternating hydrophobic and hydrophilic amino acids that give rise to the familiar antiparallel β -pleated strands with interspersed short variable lengths forming reversed turns – the “*immunoglobulin fold*” (cf. Chapter 2).

A very important feature of the Ig domain structure is mutual complementarity, which allows strong interdomain noncovalent interactions, such as those between V_H and V_L and the two C_H3 regions of immunoglobulins. Gene duplication and diversification can create mutual families of interacting molecules, such as CD4 with MHC class II, CD8 with MHC class I, and IgA with the poly-Ig receptor (Figure 10.20). Likewise, the intercellular adhesion molecules ICAM-1 and N-CAM (Figure 10.20) are richly endowed with these

	Intact chicken	Thymectomy	Bursectomy
PBL	14.5	9.1	13.3
Total Ig conc	+++	+++	-
Ab response	+++	+	-
DTH	+++	-	+++
Graft rejection	+++	+	++
GVH	+++	+	+++

Figure 10.19 Effect of neonatal bursectomy and thymectomy on the development of immunologic competence in the chicken. PBL, peripheral blood lymphocyte count $\times 10^{-3}$; Total Ig conc, concentration of circulating immunoglobulins; Ab response, antibody response to immunization with specific antigen; DTH, delayed-type hypersensitivity; GVH, graft-versus-host reaction. (Adapted from Cooper M.D. *et al.* (1966) *Journal of Experimental Medicine* **123**, 75.)

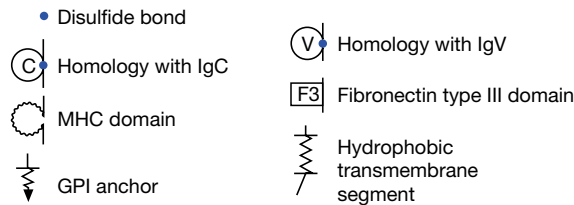
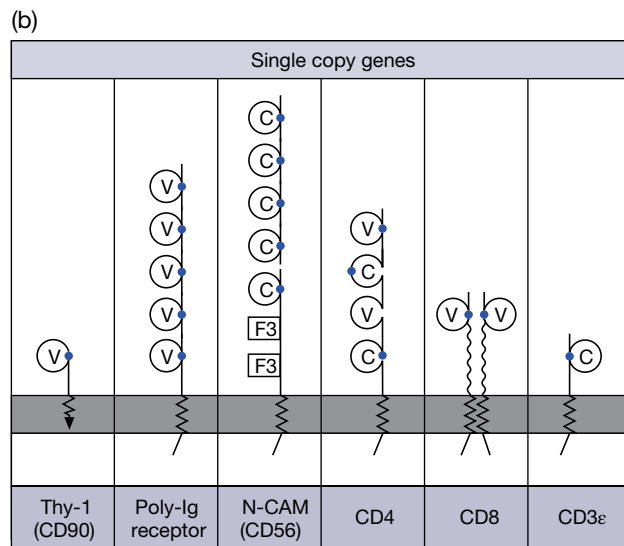
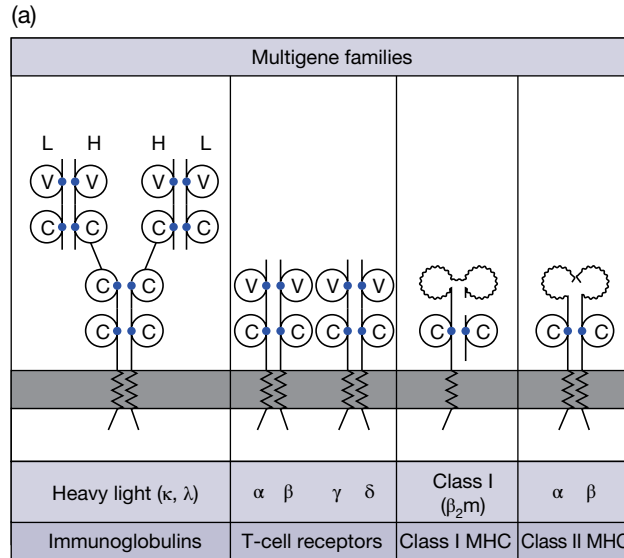


Figure 10.20 The immunoglobulin gene superfamily comprises genes encoding a large number of surface molecules that all share a common structure, the immunoglobulin-type domain, suggesting evolution from a single primordial ancestral gene. Just a few examples are shown. (a) Multigene families involved in antigen recognition (the single-copy β_2 -microglobulin [β_2m] is included because of its association with class I). (b) Single-copy genes. Thy-1 is present on T-cells and neurons. The poly-Ig receptor transports secretory IgA across mucosal membranes. N-CAM is an adhesion molecule on neuronal cells, NK cells and a subpopulation of T-cells. CD8 is found as an $\alpha\beta$ heterodimer or $\alpha\alpha$ homodimer, the α and β chain each encoded by a single gene. (Source: Hunkapiller T. and Hood L. (1986) Immunology: The growing immunoglobulin gene superfamily. *Nature* **323**, 15. Reprinted by permission from *Nature* 323, 15. Reproduced with permission of Nature Publishing Group.)

domains, and the long evolutionary history of N-CAM strongly suggests that these structures made an early appearance in phylogeny as mediators of intercellular recognition.

In marine sponges, Ig superfamily structures are found both on the extracellular portion of the receptor tyrosine kinases (RTKs) and in the cell recognition molecules (CRMs), both thought to be involved in allograft rejection.

The *integrins*, whose members include the leukocyte function-associated antigen-1 (LFA-1) and the very late antigens (VLAs), form another structural superfamily that contains a number of hematopoietic cell surface molecules concerned with adhesion to extracellular matrix proteins and to cell surface ligands; their function is to direct leukocytes to particular tissue sites.

CD antigens help distinguish different populations of leukocytes

- Cell surface molecules defined by monoclonal antibodies are assigned CD numbers that can act as “markers” of cell differentiation.

Multipotential hematopoietic stem cells from the bone marrow give rise to all the formed elements of the blood

- Expansion and differentiation are driven by soluble growth (colony-stimulating) factors and contact with reticular stromal cells.

The differentiation of T-cells occurs within the micro-environment of the thymus

- Precursor T-cells arising from stem cells in the bone marrow travel to the thymus under the influence of chemokines in order to become immunocompetent T-cells.

T-cell ontogeny

- Differentiation to immunocompetent T-cell subsets is accompanied by changes in the surface phenotype that can be recognized with monoclonal antibodies.
- TCR genes rearrange in the thymus cortex, producing a $\gamma\delta$ TCR or a pre- $\alpha\beta$ TCR, consisting of an invariant pre-T α associated with a conventional V β , before final rearrangement of the V α to generate the mature $\alpha\beta$ TCR.
- Double-negative CD4⁻CD8⁻ pre-T-cells are driven and expanded by Notch-mediated and other signals to become double-positive CD4⁺CD8⁺.
- The thymus epithelial cells positively select CD4⁺CD8⁺ T-cells with avidity for their MHC haplotype so that single-positive CD4⁺ or CD8⁺ T-cells develop that are restricted to the recognition of antigen in the context of the epithelial cell haplotype.
- NKT cells, which express both a TCR and NK cell markers such as NK1.1, have highly restricted TCR variable regions and recognize glycolipid antigens presented by the MHC-like molecule CD1d. They secrete IL-4 and IFN γ and may function as regulatory cells.

T-cell tolerance

- The induction of immunological tolerance is necessary to avoid self-reactivity.

- High-avidity T-cells that react with self-antigens presented by medullary dendritic cells and macrophages are eliminated by negative selection. The paradigm that low-avidity binding to MHC-peptide produces positive selection and high-avidity negative, is probably broadly true but may need some amendment.
- The autoimmune regulator (AIRE) directs the ectopic expression of several organ-specific self antigens in the thymic medullary epithelial cells leading to deletion of the relevant T-cells.
- Self-tolerance can also be achieved by functional inactivation of lymphocytes; anergy.
- Regulatory T-cells normally suppress the activities of self-reactive T-cells that escape the deletional or anergy processes.
- A state of what is effectively self-tolerance also arises when there is a failure to adequately present a self antigen to lymphocytes, either because of sequestration, lack of class II on the antigen-presenting cell, or low concentration of peptide-MHC (cryptic self).

B-cells differentiate in the fetal liver and then in the bone marrow

- They become immunocompetent B-cells after passing through pro-B-, pre-B-, and immature B-cell stages.
- *Pax5* expression is essential for progression from the pre-B- to immature B-cell stage.

B-1 and B-2 represent two distinct subpopulations of B-cells

- B-1 cells represent a minor population expressing high sIgM and low sIgD. B-1a cells are CD5⁺, B-1b are CD5⁻. The majority of conventional B-cells, the B-2 population, are sIgM^{lo}, sIgD^{hi}, CD5⁻ and can generate high-affinity antibodies. The B-1 population predominates in early life, shows a high level of idiotype-anti-idiotype connectivity, and produces low-affinity IgM polyreactive antibodies, many of them autoantibodies, and T-independent “natural” IgM antibacterial antibodies that appear spontaneously.

Development of B-cell specificity

- The sequence of Ig variable gene rearrangements is *DJ* and then *VDJ*.

- VDJ transcription produces μ chains that associate with VpreB λ 5 chains to form a surrogate surface IgM-like receptor.
- This receptor signals allelic exclusion of non-rearranged heavy chains and initiates rearrangement of V–Jk and, if unproductive, V–J λ .
- If the rearrangement at any stage is unproductive (i.e., does not lead to an acceptable gene reading frame), the allele on the sister chromosome is rearranged.
- The mechanisms of allelic exclusion ensure that each lymphocyte is programmed for only one antibody.

The induction of tolerance in B-lymphocytes

- B-cell tolerance is induced by clonal deletion, clonal anergy, receptor editing, and “helplessness” due to preferential tolerization of T-cells needed to cooperate in B-cell stimulation.

Natural killer (NK) cell ontogeny

- NK cells develop in the bone marrow and express inhibitory receptors for MHC class I and stimulatory receptors recognizing a variety of cell surface ligands.
- Binding of NK inhibitory receptors to self MHC molecules in a process referred to as “education” or “licensing” is a necessary step in the development of functionally mature NK cells.

The overall response in the neonate

- Maternal IgG crosses the placenta and provides a high level of passive immunity at birth.
- The innate response dominates in the neonatal period.

- Early innate and adaptive immune responses are shaped by genetics, diet, and the composition of the microbiota.

The evolution of the immune response

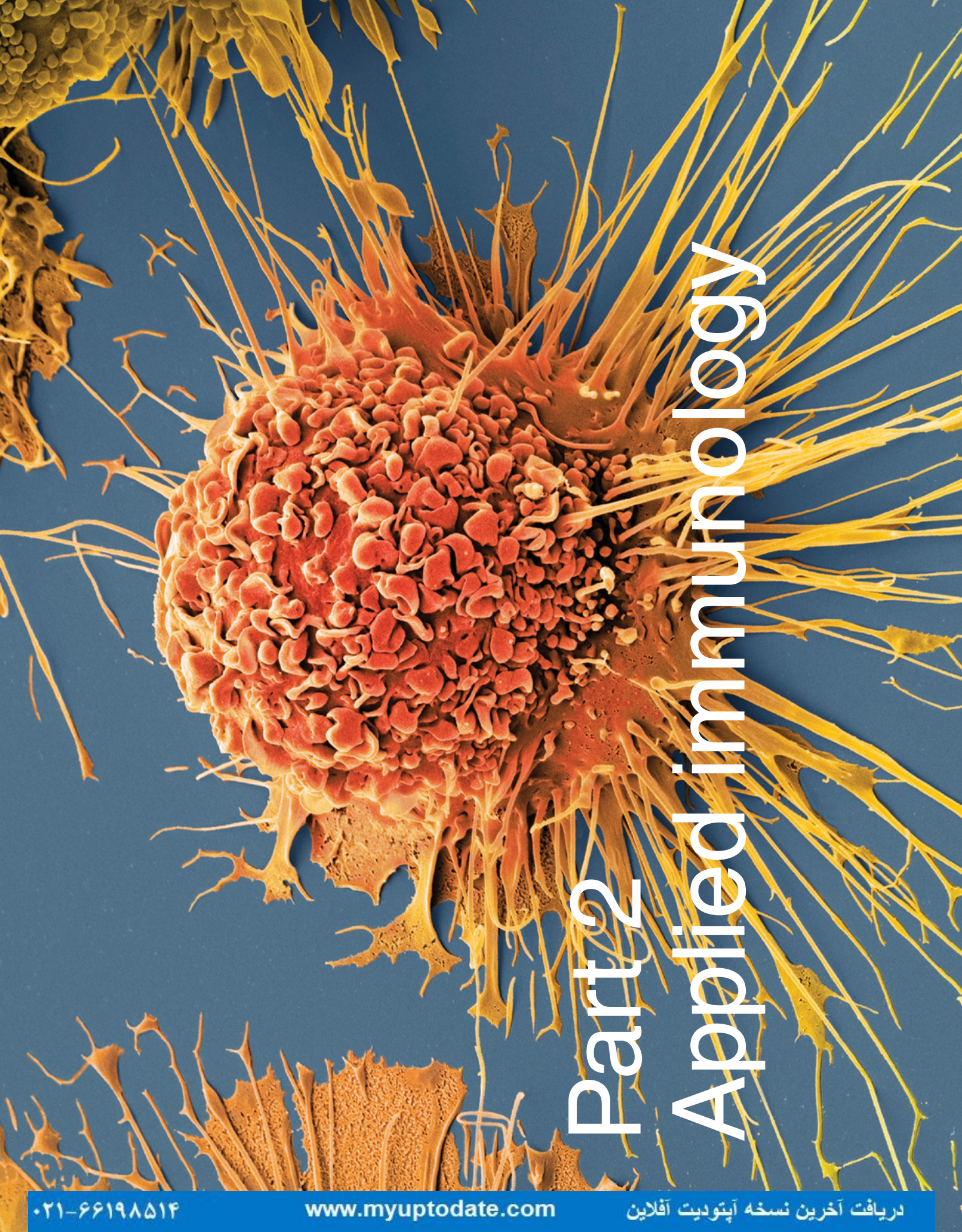
- Even prokaryotic organisms need to defend themselves from infection, for example by using restriction endonucleases to destroy foreign DNA.
- Plants utilize PAMP-triggered immunity (PTI) backed up by effector-triggered immunity (ETI) which can lead to systemic acquired resistance (SAR) to infection with broad specificity and lasting for several weeks.
- Recognition of self is of fundamental importance for multicellular organisms, even lowly forms such as marine sponges.
- Invertebrates have defense mechanisms based on phagocytosis, killing by a multiplicity of microbicidal peptides, and imprisonment of the invader by coagulation of the hemolymph.
- B- and T-cell responses are well defined in the vertebrates and the evolution of these distinct lineages was accompanied by the development of separate sites for differentiation.
- The success of the immunoglobulin domain structure, through its ability to give noncovalent mutual binding, has been exploited by evolution to produce the very large Ig gene superfamily of recognition molecules, including Ig, TCRs, MHC class I and II, β_2 -microglobulin, CD4, CD8, the poly-Ig receptor, and Thy-1. Another superfamily, the integrins, which includes LFA-1 and the VLA molecules, is concerned with leukocyte binding to endothelial cells and extracellular matrix proteins.



Now visit www.roitt.com to test yourself on this chapter.

FURTHER READING

- Chien Y-H., Meyer C., and Bonneville M. (2014) $\gamma\delta$ T cells: First line of defense and beyond. *Annual Review of Immunology* **32**, 121–155.
- Cook D.E., Mesarich C.H. and Thomma B.P. (2015) Understanding plant immunity as a surveillance system to detect invasion. *Annual Review Phytopathology* **53**, 541–563.
- Fink P.J. (2013) The biology of recent thymic emigrants. *Annual Review of Immunology* **31**, 31–50.
- Flajnik M.F. and Kasahara M. (2010) Origin and evolution of the adaptive immune system: genetic events and selective pressures. *Nature Reviews Genetics* **11**, 47–59.
- Frenette P.S., Pinho S., Lucas D., and Scheiermann C. (2013) Hematopoietic stem cell niche and a stepping-stone for regenerative medicine. *Annual Review of Immunology* **31**, 285–316.
- Melchers F. (2015) Checkpoints that control B cell development. *Journal of Clinical Investigation* **125**, 2203–2210.
- PrabhuDas M., Adkins B., Gans H., *et al.* (2011) Challenges in infant immunity: implications for responses to infection and vaccines. *Nature Immunology* **12**, 189–194.
- Prinz I., Silva-Santos B., and Pennington D.J. (2013) Functional development of $\gamma\delta$ T cells. *European Journal of Immunology* **43**, 1988–1994.
- Seo W. and Taniuchi I. (2016) Transcriptional regulation of early T-cell development in the thymus. *European Journal of Immunology* **46**, 531–538.
- Tarlinton D. and Good-Jacobson K. (2013) Diversity among memory B cells: origin, consequences, and utility. *Science* **341**, 1205–1211.
- Ugarte F. and Forsberg E.C. (2013) Haematopoietic stem cell niches: new insights inspire new questions. *The EMBO Journal* **32**, 2535–2547.



Part 2 Applied immunology

CHAPTER 11

Adversarial strategies during infection

Key topics

■ Infection remains a major healthcare problem	322
■ Inflammation revisited	322
■ Bacterial survival strategies	326
■ The host counterattack against bacteria	329
■ The habitat of intracellular bacteria allows avoidance of many of the host defenses	334
■ Virus survival strategies	338
■ The host counterattack against viruses	341
■ Immunity to fungi	342
■ Immunity to parasitic infections	344
■ Prions	349

Just to recap ...

The immune system has a wide range of cells and molecules at its disposal to fight infection. Phagocytes engulf small pathogens such as bacteria, viruses, and fungi and then use a broad range of microbicidal components to destroy the trapped organism. Pathogens that are too large to be engulfed, for example parasitic worms, can be destroyed by the release of toxic substances from cells such as eosinophils. Antibody is also effective against extracellular pathogens and acts predominantly through its effects as an opsonin for phagocytosis and by initiating the classical pathway of complement activation. Complement can also be directly activated by extracellular pathogens, via either the alternative or lectin pathways. The immune system must employ different strategies for intracellular pathogens as these are not generally susceptible to phagocytic cells or humoral immunity. Cytotoxic T-lymphocytes and NK cells will kill virus-infected host cells, thereby depriving the pathogen of the ability to replicate. In the case of intracellular bacteria, such as *Mycobacterium tuberculosis* residing in macrophages, the macrophage-activating properties of $\text{IFN}\gamma$ is of value.

Introduction

Our microbial adversaries have tremendous opportunities to evolve strategies that evade the immune defenses. Many bacteria can divide every 20–60 minutes or so, and replication of their nucleic acid provides an opportunity for mutations that can result in changes to the antigens recognized by the immune system. Viruses and parasites are also constantly altering their antigens by mutation and other mechanisms.

Pathogens continue to take a terrifying toll (Figure 11.1), particularly in the developing world. Newly emerged infections including H1NI and H5NI influenza A variants, *E. coli* 0157:H7, *Clostridium difficile*, prions, *Legionella pneumophila*, *Chlamydia trachomatis*, HIV, and Ebola virus are stretching healthcare resources. Furthermore, old adversaries have re-emerged, such as dengue, West Nile virus, cholera, plague, Rift Valley fever, and Lyme disease. Over half of all human pathogens are zoonoses, infections that are present in species other than humans but that can be transmitted from animals to humans. Climate changes that are currently occurring as a result of global warming may lead to an increase in vector-borne infectious diseases such as malaria in many areas of the world including the United States and Europe. In this chapter we look at the varied, often ingenious, adversarial strategies that we and our enemies have developed.

Infection remains a major healthcare problem

In the middle of the last century it had seemed that the introduction of antibiotics and other drugs against pathogens had finally beaten infectious disease, but now multidrug resistance has become an extremely worrying development, as seen with

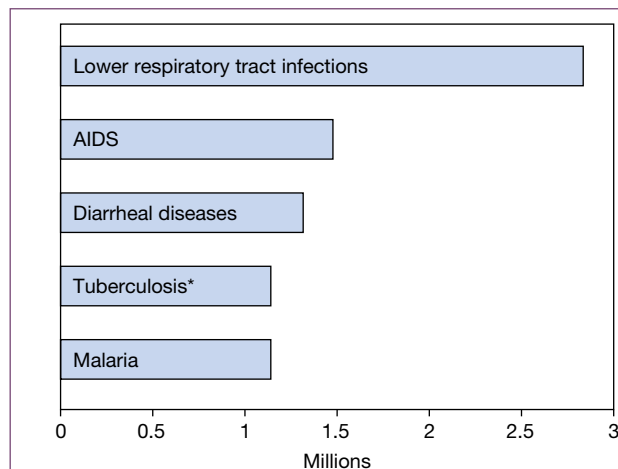


Figure 11.1 Estimated annual deaths from infectious disease. These five causes account for approximately 90% of the deaths from infectious disease worldwide. *Excludes deaths from tuberculosis in patients infected with HIV. (Data based on the Global Burden of Disease Study 2010 from Lozano R. *et al.* (2012) *Lancet* **380**, 2095–2128.)

tuberculosis, malaria, *Streptococcus pneumoniae*, *Enterococcus faecalis*, *Pseudomonas aeruginosa*, and methicillin-resistant *Staphylococcus aureus* (MRSA). Resistance to sulfa drugs occurred in *S. aureus* in the 1940s, to penicillin in the 1950s, to methicillin in the 1980s, and to vancomycin in 2002.

Infections arising after 48 hours of hospital admission may well have been acquired in the hospital and are then referred to as nosocomial infections; MRSA and other multidrug-resistant organisms often lurk in such institutions, as does *Clostridium difficile* type 027, which carries a mutation resulting in high levels of toxin production. It is also becoming increasingly appreciated that infectious agents are related to many “non-infectious” diseases, such as the association of *Helicobacter pylori* with gastric ulcers and gastric cancer, and of various viruses with other cancers.

Inflammation revisited

The initial reaction to pathogens that breach the external protective barriers is usually an acute inflammatory response involving an influx of leukocytes, complement, antibody, and other plasma proteins into a site of infection or injury. This was discussed in the introductory chapters but let us now re-examine the mechanisms of inflammation in greater depth. The reader may find it helpful to have another look at the relevant sections in Chapters 1 and 2, particularly those relating to Figure 1.13 and Figure 1.14.

Mediators of inflammation

A complex variety of mediators are involved in acute inflammatory responses (Figure 11.2). Some act directly on the smooth muscle wall surrounding the arterioles to alter blood flow.

Mediator action					
	Dilatation	Increase permeability	Upregulate adhesion molecules		Neutrophil chemotaxis
			Endothelium	Neutrophil	
Histamine	+	+	++		
Bradykinin	+	++			
PGE ₂	+++	Potentiates other mediators			
C5a		++	+	++	+++
Leukotriene-B ₄		++		++	+++
f.Met.Leu.Phe		++		+	+
Platelet-activating factor	+	++		++	
IL-8 (CXCL8)				+++	+++
NAP-2 (CXCL7)				++	++
IL-1 β			++	++	
TNF			++	++	

Artery	Arteriole	Capillaries	Venule	Vein
--------	-----------	-------------	--------	------

Figure 11.2 The principal mediators of acute inflammation. The reader should refer back to Figure 1.14 to recall the range of products generated by the mast cell. The later acting cytokines such as the interleukin IL-1 β are largely macrophage-derived and these cells also secrete prostaglandin E₂ (PGE₂), leukotriene B₄, and the neutrophil-activating chemokine NAP-2 (CXCL7).

Others act on the venules to cause contraction of the endothelial cells with transient opening of the interendothelial junctions and consequent transudation of plasma. The migration of leukocytes from the bloodstream is facilitated by soluble mediators that upregulate the expression of adhesion molecules on both blood vessel endothelium and on leukocytes. Other mediators act as chemotactic factors to attract the leukocytes to the site of inflammation.

Leukocytes bind to endothelial cells through paired adhesion molecules

The leukocytes that are charging along in the blood vessels need to be redirected to migrate into the inflamed site. This is somewhat like having to encourage bulls stampeding down the Pamplona main street to move quietly into the side roads. The adherence of leukocytes to the endothelial vessel wall through

the interaction of complementary binding of cell surface molecules is an absolutely crucial step. Several classes of molecule subserve this function, some acting as lectins to bind a carbohydrate ligand on the complementary partner.

Initiation of the acute inflammatory response

A very early event is the upregulation of P-selectin and platelet-activating factor (PAF) on the endothelial cells lining the venules by histamine or thrombin released by the original inflammatory stimulus. Recruitment of these molecules from intracellular storage vesicles ensures that they appear within minutes on the cell surface. This alerts the neutrophils to the fact that there is an infection or tissue damage in the vicinity; it's a bit like putting your hand out to stop the bus. Engagement of the lectin-like domain at the tip of the P-selectin molecule with sialyl-Lewis^x carbohydrate determinants borne by the

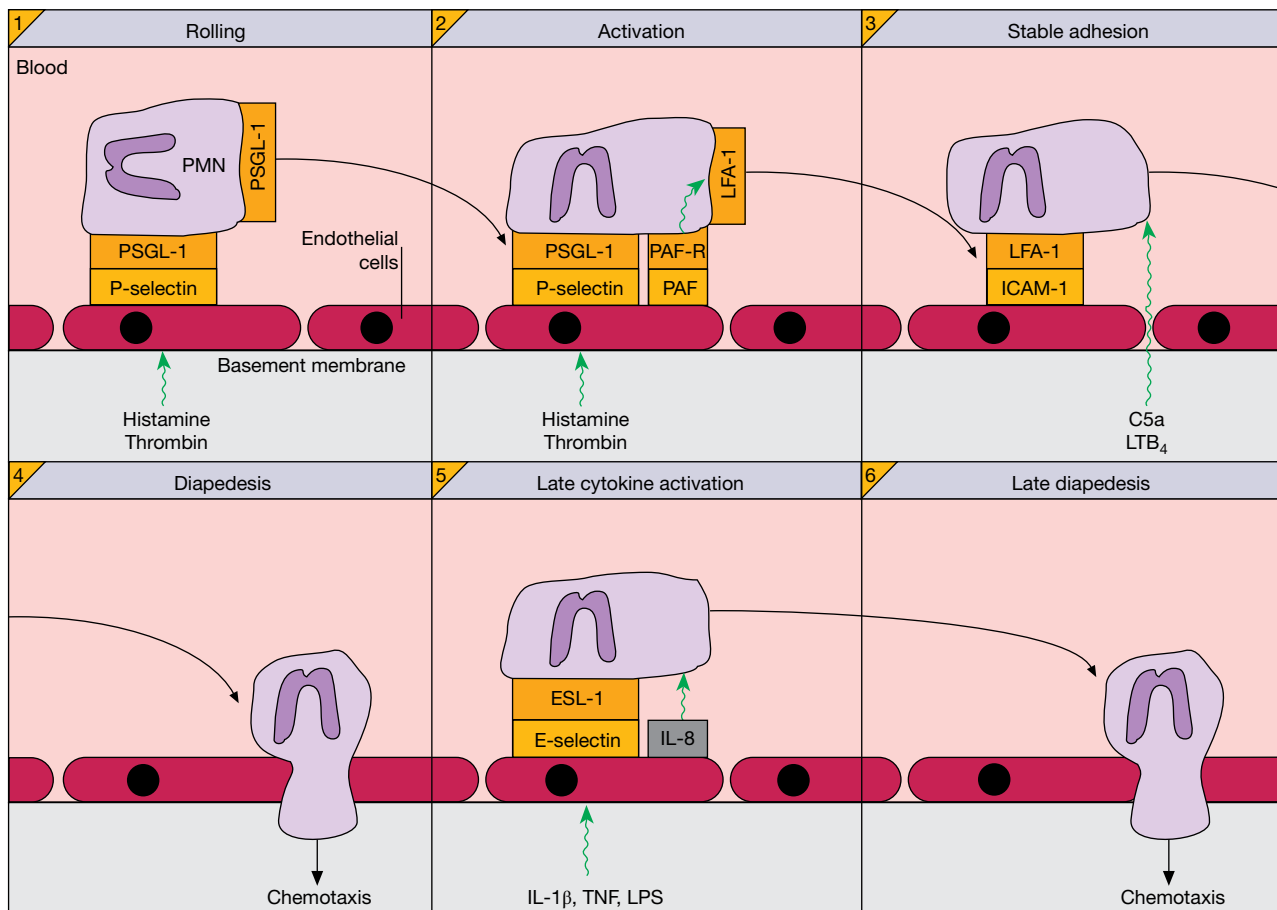


Figure 11.3 Early events in inflammation affecting neutrophil margination and diapedesis. (1) Mediators such as histamine and thrombin induce the upregulation of P-selectin on the vessel wall. Leukocyte–endothelial interaction (rolling) occurs following binding to ligands on the polymorphonuclear neutrophil (PMN) such as P-selectin glycoprotein ligand-1 (PSGL-1, CD162). (2) Subsequent induction of platelet-activating factor (PAF) and its engagement with the PAF receptor on the neutrophil activates the leukocyte, resulting in expression of integrins such as leukocyte functional antigen-1 (LFA-1) and Mac-1 (not shown). (3) Intercellular adhesion molecule-1 (ICAM-1) also becomes expressed on the endothelium, permitting stable adhesion via interaction with the LFA-1. A chemotactic gradient is provided by C5a and leukotriene B₄ (LTB₄), leading to (4) diapedesis of the activated neutrophils. (5) Subsequent expression of endothelial E-selectin (promoted by IL-1 β , TNF, and LPS) and of IL-8 induce binding and activation of more neutrophils and (6) their diapedesis into the tissues. (Compare events involved in homing and transmigration of lymphocytes, Figure 6.14.)

P-selectin glycoprotein ligand-1 (PSGL-1) on the neutrophil surface causes the cell to slow and then *roll* along the endothelial wall and helps PAF to dock onto its corresponding receptor. This, in turn, increases surface expression of the integrins leukocyte function-associated antigen-1 (LFA-1) and Mac-1, which bind the neutrophil very firmly to the endothelial surface (Figure 11.3).

Activation of the neutrophils also increases their responsiveness to chemotactic agents and, under the influence of C5a and leukotriene B₄, they exit from the circulation and use a process referred to as *diapedesis* to squeeze through the loosened junctions between the blood vessel endothelial cells. They then migrate across the basement membrane and up the chemotactic gradient to the inflammation site. Here they phagocytose the microorganisms and use their various killing

mechanisms to destroy the pathogen (see Chapter 1). Additionally, they release neutrophil extracellular traps (NETs), which act like a spider's web to ensnare the prey and thereby prevent them from spreading (Figure 11.4). The NETs contain a number of antimicrobial agents including elastase, proteinase 3, gelatinase, trypsin, bactericidal permeability-increasing protein (BPI), cathepsin G, myeloperoxidase, lactoferrin, and the cathelicidin LL-37, thereby also contributing directly to destruction of the microorganisms.

Damage to the vascular endothelium, which exposes the basement membrane, and bacterial toxins such as lipopolysaccharide (LPS), trigger the blood coagulation and fibrinolysis pathways. Activation of platelets, for example by contact with basement membrane collagen or induced endothelial PAF, leads to the release of many inflammatory mediators including

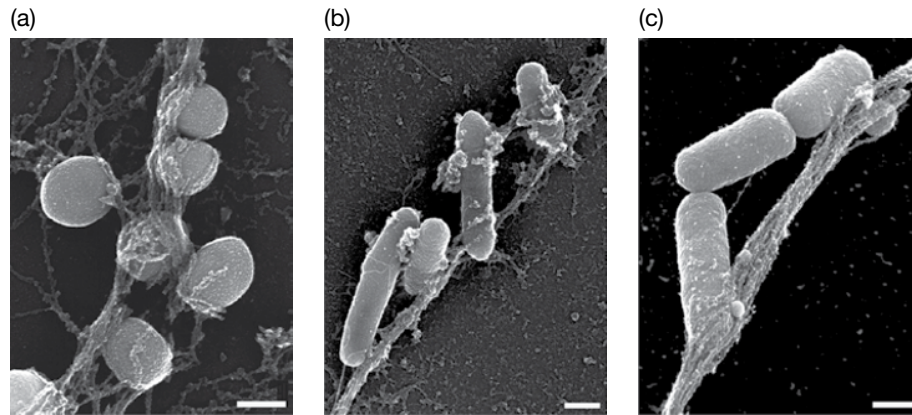


Figure 11.4 Neutrophil extracellular traps. Release of granule proteins and chromatin from neutrophils leads to the formation of neutrophil extracellular traps (NETs), which prevent bacterial spreading and ensure that microbicidal substances released from the neutrophils are kept in the immediate vicinity of the bacteria for optimal killing of the microbe and minimal collateral damage to host tissues. Scanning electron micrograph of NETs from IL-8 activated neutrophils trapping: (a) *Staphylococcus aureus*; (b) *Salmonella typhimurium*; (c) *Shigella flexneri*. The bar indicates 500 nm. (Source: Brinkman V. *et al.* (2004) *Science* **303**, 1532. Reproduced with permission of AAAS.)

histamine and a number of chemokines that are stored in granules. Some newly synthesized mediators, such as IL-1 β , are translated from mRNA in the anucleate platelets. Aggregation of the activated platelets occurs and **thrombus** formation is initiated by adherence through platelet glycoprotein Ib to von Willebrand factor on the vascular surface. Such platelet plugs are adept at stemming the loss of blood from a damaged artery, but in the venous system the damaged site is sealed by a **fibrin clot** resulting from activation of the intrinsic clotting system via contact of Hageman factor (factor XII) with the exposed surface of the basement membrane. Activated Hageman factor also triggers the kinin and plasmin systems and several of the resulting products influence the inflammatory process, including bradykinin and fibrinopeptides that, together with complement components C3a and C5a, increase vascular permeability and thrombin, which contributes towards activation of endothelium.

The ongoing inflammatory process

Tissue macrophages stimulated by local infection or injury secrete an impressive array of mediators. In particular, the cytokines IL-1 β and TNF act at a later time than histamine or thrombin to stimulate the endothelial cells and maintain the inflammatory process by upregulating E-selectin and sustaining P-selectin expression. Thus, expression of E-selectin occurs 2–4 hours after the initiation of acute inflammation, being dependent upon activation of gene transcription. The E-selectin engages the glycoprotein E-selectin ligand-1 (ESL-1) on the neutrophil. Other later acting components are the **chemokines** (chemotactic cytokines) IL-8 (CXCL8) and neutrophil-activating peptide-2 (NAP-2, CXCL7), which are highly effective neutrophil chemoattractants. IL-1 β and TNF also act on endothelial cells, fibroblasts, and epithelial cells to stimulate

secretion of another chemokine, MCP-1 (CCL2), which attracts mononuclear phagocytes to the inflammatory site to strengthen and maintain the defensive reaction to infection.

Perhaps this is a good time to remind ourselves of the important role of chemokines (Table 8.2) in selectively attracting multiple types of leukocytes to inflammatory foci. Inflammatory chemokines are typically induced by microbial products such as LPS and by proinflammatory cytokines including IL-1 β , TNF, and IFN γ . As a very broad generalization, chemokines of the CXC subfamily, such as IL-8, are specific for neutrophils and, to varying extents, lymphocytes, whereas chemokines with the CC motif are chemotactic for T-cells, monocytes, dendritic cells, and variably for natural killer (NK) cells, basophils, and eosinophils. Eotaxin (CCL11) in particular is chemotactic for eosinophils, and the presence of significant concentrations of this mediator together with RANTES (regulated upon activation normal T-cell expressed and secreted [CCL5]) in mucosal surfaces contribute towards the increased numbers of eosinophils in those tissues. The different chemokines bind to particular heparin and heparan sulfate glycosaminoglycans so that, after secretion, the chemotactic gradient can be maintained by attachment to the extracellular matrix as a form of scaffolding.

Clearly, this whole operation serves to focus the immune defenses around the invading microorganisms. These become coated with antibody, the complement components C3b, iC3b, and C4b, and certain acute phase proteins such as C-reactive protein. They are thereby targeted for phagocytosis by the neutrophils and macrophages; under the influence of the inflammatory mediators these have upregulated complement and Fc receptors, enhanced phagocytic responses and hyped-up killing powers, all adding up to bad news for the microbe.

Of course it is beneficial to recruit lymphocytes to sites of infection and we should remember that endothelial cells in

these areas express VCAM-1, which acts as a homing receptor for VLA-4-positive activated memory T-cells, while many chemokines (see Table 8.2) are chemotactic for lymphocytes.

Regulation and resolution of inflammation

With its customary prudence, evolution has established regulatory mechanisms to prevent inflammation from getting out of hand. At the humoral level we have a series of complement regulatory proteins: C1 inhibitor, C4b-binding protein, the C3 control proteins factors H and I, complement receptor CR1 (CD35), decay accelerating factor (DAF, CD55), membrane cofactor protein (MCP, CD46), immunoglobulin, and homologous restriction factor 20 (HRF20, CD59). Some of the acute phase proteins derived from the plasma transudate, including α -1 antichymotrypsinogen, α -1 antitrypsin, heparin cofactor-2 and plasminogen-activator inhibitor-1, are protease inhibitors that help protect the tissues from the proteases released from inflammatory cells such as neutrophils.

At the cellular level, prostaglandin E_2 (PGE_2), transforming growth factor β (TGF β), and glucocorticoids are powerful regulators. PGE_2 is a potent inhibitor of lymphocyte proliferation and cytokine production by T-cells and macrophages. TGF β deactivates macrophages by inhibiting the production of reactive oxygen intermediates and downregulating MHC class II expression. Endogenous glucocorticoids produced via the hypothalamic-pituitary-adrenal axis exert their anti-inflammatory effects both through the repression of a number of genes for proinflammatory cytokines and adhesion molecules, and the induction of the inflammation inhibitors lipocortin-1, secretory leukocyte proteinase inhibitor (SLPI, an inhibitor of neutrophil elastase), and IL-1 receptor antagonist. IL-10 inhibits antigen presentation, cytokine production, and nitric oxide (NO) killing by macrophages, the latter inhibition being greatly enhanced by synergistic action with IL-4 and TGF β .

Once the agent that has provoked the inflammatory reaction has been cleared, any damaged tissue will be repaired. When the inflammation traumatizes tissues through its intensity and extent, TGF β plays a major role in the subsequent wound healing by stimulating fibroblast division and the laying down of new extracellular matrix elements.

Chronic inflammation

If an inflammatory agent persists, either because of its resistance to metabolic breakdown or through the inability of a deficient immune system to clear an infectious microbe, the character of the cellular inflammatory response changes. The site becomes dominated by macrophages with varying morphology: many have an activated appearance, some may form what are termed “epithelioid” cells and others may fuse to form giant cells. Lymphocytes in various guises are also often present. Often a structure referred to as a *granuloma* forms and surrounds the infectious agents thereby isolating them from the remainder of the body (see type IV hypersensitivity in Chapter 14).

Bacterial survival strategies

Most bacteria have an extracellular existence, making them susceptible to *phagocytic cells* and *complement*. Neutrophils and macrophages can employ their *pattern recognition receptors* to directly recognize *pathogen-associated molecular patterns (PAMPs)* on the microbe. Complement can be activated by the alternative or lectin pathways. However, things get positively uncomfortable for the microorganisms when *antibody* arrives on the scene, as then complement can also be activated via the classical pathway, not to mention the fact that the bacteria will become very effectively opsonized for enhanced phagocytosis (see Figure 2.1). However, the organisms don't take all this lying down and there are a vast array of strategies that they have developed in order to avoid being destroyed.

As with virtually all infectious agents, if you can think of a possible avoidance strategy, some microbe will already have developed it (Table 11.1).

Evading phagocytosis

The cell walls of bacteria are not all the same (Figure 11.5) and in some cases are inherently resistant to microbicidal agents; but many other strategies are used to evade either phagocytic (Figure 11.6) or complement-mediated (Figure 11.7) defenses. A common mechanism by which virulent bacteria escape phagocytosis is by synthesis of an outer *capsule*, which does not adhere readily to phagocytic cells and covers carbohydrate molecules on the bacterial surface that could otherwise be recognized by phagocyte receptors. For example, as few as 10 encapsulated pneumococci can kill a mouse but, if the capsule is removed by treatment with hyaluronidase, 10 000 bacteria are required in order to produce a fatal infection. Many pathogens evolve capsules that physically prevent access of phagocytes to C3b deposited on the bacterial cell wall.

Other organisms have actively *antiphagocytic* cell surface molecules and some go so far as to secrete *exotoxins* which poison the leukocytes. Yet another strategy is to gain entry into a nonphagocytic cell and thereby hide from the professional phagocyte.

Evading complement

Poor activation

Bacterial capsules again play a role. In general they tend to be poor activators of complement and selective pressures have favored the synthesis of capsules whose surface components do not permit stable binding of the alternative pathway convertase C3bBb.

Accelerated breakdown

Factor H, factor H-like protein 1 (FHL-1), and C4b-binding protein (C4BP) are members of the regulators of complement activation (RCA) family. Certain bacterial surface molecules, notably those rich in sialic acid, bind factor H, which then acts



Table 11.1 Examples of mechanisms used by bacteria to avoid the host immune response.

Immune process	Example	Mechanism
Phagocytosis	<i>Pneumococcus</i>	Capsule limits adherence (see Figure 11.6)
	<i>Yersinia enterocolitica</i>	Inhibition of actin skeleton in phagocytes by YopT cleavage of RhoA (see Figure 11.8)
Complement	<i>Haemophilus influenzae</i>	Cleavage of C5a by a protease (see Figure 11.7)
	<i>Neisseria gonorrhoeae</i>	Inhibition of insertion of membrane attack complex (see Figure 11.7)
Apoptosis	<i>Shigella flexneri</i>	IpaB-mediated activation of caspase-1 induces apoptosis (see Figure 11.8)
	<i>Mycobacterium tuberculosis</i>	Increased expression of <i>bcl2</i> and Rb inhibits apoptosis
Cytokine production	<i>Vibrio cholerae</i>	Cholera toxin inhibition of IL-12 secretion
	<i>Bordetella pertussis</i>	Pertussis toxin induction of IL-1 β and IL-4
Antibody	<i>Staphylococcus aureus</i>	IgG opsonization for phagocytosis blocked by protein A binding the antibody the “wrong way round”
	<i>Neisseria gonorrhoeae</i>	Antigenic variation by recombination within <i>pilE</i> gene
T-cell activation	<i>Helicobacter pylori</i>	VacA vacuolating cytotoxin inhibits calcineurin signaling pathways
	<i>Salmonella typhimurium</i>	Interferes with ability of dendritic cells to present antigen to T-cells

Adapted from Merrell D.S. and Falkow S. (2004) *Nature* 430, 250. Reproduced with permission of Nature Publishing Group.

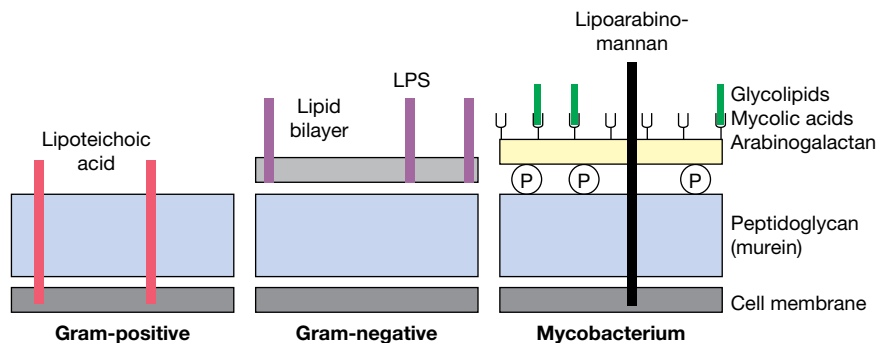


Figure 11.5 The structure of bacterial cell walls. All types have an inner cell membrane and a peptidoglycan wall that can be cleaved by lysozyme. The outer lipid bilayer of Gram-negative bacteria, which is susceptible to the action of complement or cationic proteins, sometimes contains lipopolysaccharide (LPS; also known as endotoxin; composed of a membrane-distal hydrophilic polysaccharide [which forms the highly polymorphic O-specific antigens] attached to a basal core polysaccharide, itself linked to the hydrophobic membrane-anchoring lipid A). Over 170 O antigen variants of *Escherichia coli* are known. The mycobacterial cell wall is highly resistant to breakdown. Gram-positive and Gram-negative bacteria sometimes also possess fimbriae or flagellae. All three types of bacterial cell wall (Gram-positive, Gram-negative, and mycobacterial) may or may not be covered by an outer capsule. When present, outer capsules often protect the bacteria from phagocytosis.

as a focus for the degradation of C3b by the serine protease factor I (see Chapter 1). This is seen, for example, with *Neisseria gonorrhoeae*. Similarly, the hypervariable regions of the M-proteins of certain *Streptococcus pyogenes* (group A streptococcus) strains are able to bind FHL-1, whereas other strains down-regulate complement activation by interacting with C4BP, this time acting as a cofactor for factor I-mediated degradation of the C4b component of the classical pathway C3 convertase C4b2a. *Haemophilus influenzae*, all group A streptococci, and

group B, C, and G streptococci of human origin produce a C5a peptidase that acts as a virulence factor by proteolytically cleaving and thereby inactivating C5a.

Deviation

Some species manage to avoid lysis by deviating the complement activation site either to a secreted decoy protein or to a position on the bacterial surface distant from the cell membrane.

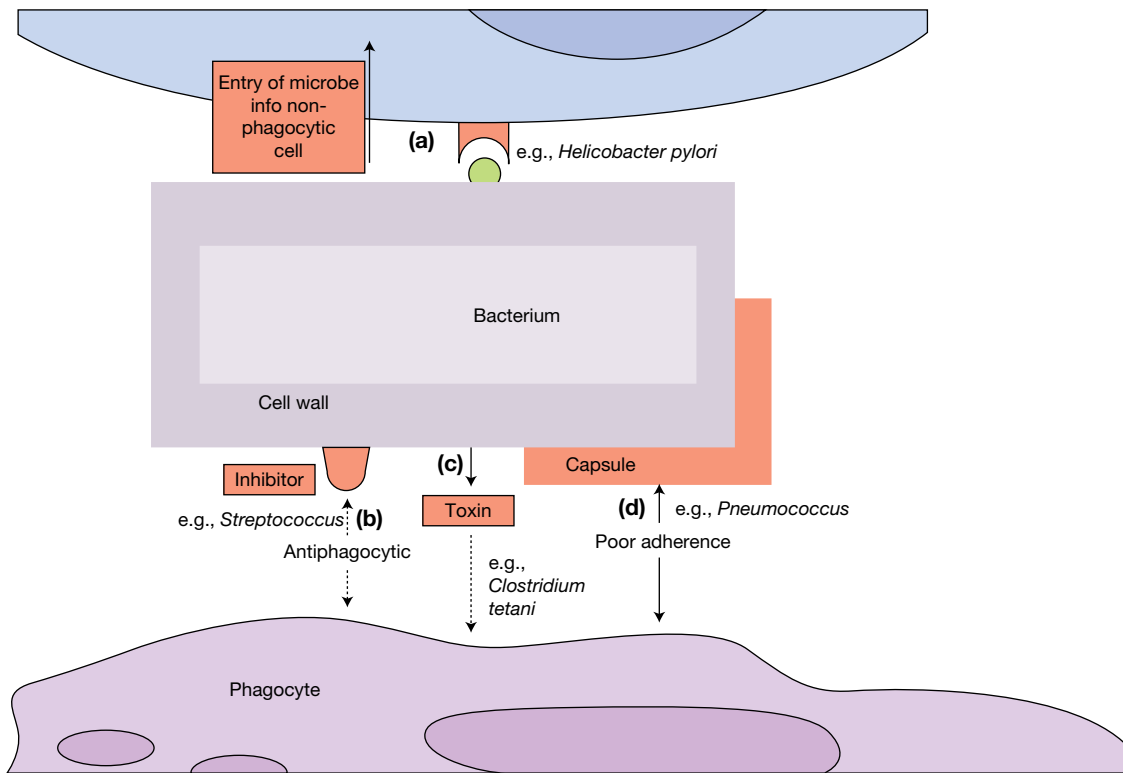


Figure 11.6 Phagocytosis avoidance strategies by extracellular bacteria. (a) Microbe attaches to surface component to enter nonphagocytic cell; (b) surface inhibitor of phagocytosis; (c) exotoxin poisons phagocyte; (d) capsule gives poor phagocyte adherence.

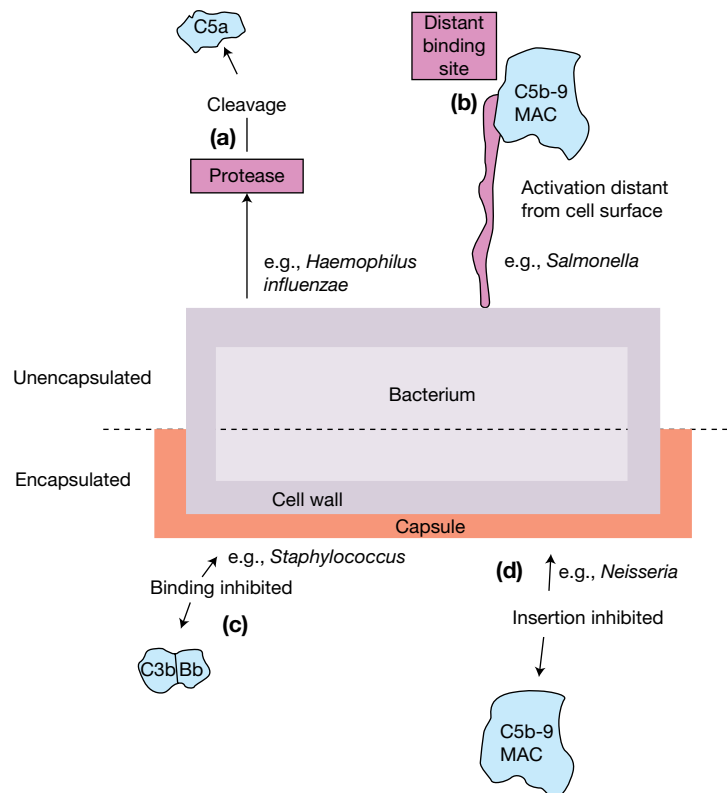


Figure 11.7 Complement avoidance strategies by extracellular bacteria. (a) Accelerated breakdown of complement by action of microbial products; (b) complement effectors are deviated from the microbial cell wall; (c) capsule provides nonstabilizing surface for alternative pathway convertase; (d) capsule impervious to complement membrane attack complex (MAC).

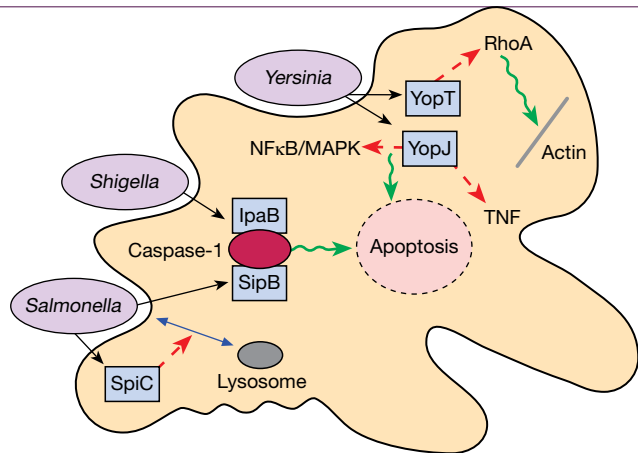


Figure 11.8 Evasion of macrophage defenses by enteric bacteria. The IpaB (invasion plasmid antigen B) and SipB (*Salmonella* invasion protein B) molecules secreted by *Shigella* and *Salmonella*, respectively, can activate caspase-1 and thereby set off a train of events that will lead to the death of the macrophage by apoptosis. The SpiC (*Salmonella* pathogenicity island C) protein from *Salmonella* inhibits the trafficking of cellular vesicles, and therefore is able to prevent lysosomes fusing with phagocytic vesicles. *Yersinia* produces a number of Yop molecules (*Yersinia* outer proteins) able to interfere with the normal functioning of the phagocyte. For example, YopJ inhibits TNF production and downregulates NFκB and MAP kinases, thereby facilitating apoptosis by inhibiting anti-apoptotic pathways. YopT prevents phagocytosis by modifying the GTPase RhoA involved in regulating the actin cytoskeleton. (Adapted from Donnenberg M.S. (2000) *Nature* **406**, 768.)

Resistance

Gram-positive organisms (see Figure 11.5) have evolved thick peptidoglycan layers that resist the insertion of the lytic C5b–9 membrane attack complex (MAC) into the bacterial cell membrane. Many capsules do the same (Figure 11.7).

Evading killing by macrophages

Enteric Gram-negative bacteria in the gut have developed a number of ways of influencing macrophage activity, including inducing apoptosis, preventing phagosome–lysosome fusion, and affecting the actin cytoskeleton (Figure 11.8).

Antigenic variation

Individual antigens can be altered in the face of a determined host antibody response. Examples include variation of surface lipoproteins in the Lyme disease spirochete *Borrelia burgdorferi*, of enzymes involved in synthesizing surface structures in *Campylobacter jejuni*, and of the pili in *Neisseria meningitidis*. In addition, new strains can arise, as has occurred with the life-threatening *E. coli* 0157:H7 that can cause hemolytic uremic syndrome and appears to have emerged about 50 years ago by incorporation of shiga toxin genes into the *E. coli* 055 genome.

The host counterattack against bacteria

Antibodies can defeat these devious attempts to avoid engulfment by neutralizing the antiphagocytic molecules and by binding to the surface of the organisms to activate complement, so opsonizing the pathogen for ingestion by neutrophils and macrophages or setting them up for lysis by the terminal membrane attack complex (Milestone 11.1). However, antibody production by B-cells usually requires T-cell help, and the T-cells need to be activated by antigen-presenting cells.

As already discussed in Chapter 1, but so important that it is worth repeating, pathogen-associated molecular patterns (PAMPs), such as the all-important lipopolysaccharide (LPS) endotoxin of Gram-negative bacteria, peptidoglycan, lipoteichoic acids, mannans, bacterial DNA, double-stranded RNA, and glucans, are molecules that are broadly expressed by microbial pathogens but not present on host tissues. Thus these molecules serve as an alerting service for the immune system, which detects their presence using pattern recognition receptors (PRRs) expressed on the surface of antigen-presenting cells. It will be recalled that such receptors include the mannose receptor (CD206) and the scavenger receptor (CD204), which mediate phagocytic clearance of bacteria from the circulation. LPS-binding protein (LBP) transfers LPS to the CD14 PRR on monocytes, macrophages, dendritic cells, and B-cells. This leads to the recruitment of the Toll-like receptor 4 (TLR4) molecule, which triggers expression of proinflammatory genes, including those for IL-1β, IL-6, IL-12, and TNF, and the upregulation of the CD80 (B7.1) and CD86 (B7.2) co-stimulatory molecules. Although each of the 13 Toll-like receptors recognize broadly expressed microbial structures, it has been suggested that collectively they are able to some extent to discriminate between different pathogens by detection of particular combinations of PAMPs in a “bar-code”-type approach.

Toxin neutralization

Circulating antibodies can neutralize the soluble antiphagocytic molecules and other exotoxins (e.g., phospholipase C of *Clostridium perfringens*) released by bacteria. Binding of the antibody in the vicinity of the biologically active site of the toxin stereochemically blocks reaction with the substrate, whereas combination distant from the active site may also cause inhibition through allosteric conformational changes. When complexed to antibody, the toxin may be unable to diffuse away rapidly and will be susceptible to phagocytosis.

Opsonization of bacteria

Independently of antibody

Differences between the carbohydrate structures on bacteria and self are exploited by the **collectins**, a series of molecules with similar ultrastructure to C1q and that bear C-terminal lectin domains. These include mannose-binding lectin (MBL)

Milestone 11.1 The protective effects of antibody

The pioneering research that led to the recognition of the antibacterial protection afforded by antibody clustered in the last years of the nineteenth century. A good place to start the story is the discovery by Emile Roux and Alexandre Yersin in 1888, at the Pasteur Institute in Paris, that the exotoxin of diphtheria bacillus could be isolated from a bacteria-free filtrate of the medium used to culture the organism. Emil von Behring (Figure M11.1.1) and Shibasaburo Kitasato at Koch's Institute in Berlin in 1890 then went on to show that animals could develop an immunity to such toxins that was due to the development of specific neutralizing substances referred to generally as **antibodies** (anti-foreign bodies) (Figure M11.1.2). They further succeeded in passively transferring immunity to another animal with serum containing the antitoxin. The dawning of an era of serotherapy came in 1894 with Roux's successful treatment of patients with diphtheria by injection of immune horse serum.

Sir Almroth Wright (Figure M11.1.3) in London in 1903 proposed that the main action of the increased antibody produced after infection was to reinforce killing by the phagocytes. He called the antibodies **opsonins** (Gk. *opson*, a dressing or relish), because they prepared the bacteria as food for the phagocytic cells, and amply verified his predictions by showing that antibodies dramatically increased the phagocytosis of bacteria *in vitro*, thereby cleverly linking innate to adaptive immunity.

George Bernard Shaw even referred to Almroth Wright's proposal in his play *The Doctor's Dilemma*. In the preface he gave an evocative description of the function of opsonins: "the white corpuscles or phagocytes that attack and devour disease germs for us do their work only when we butter the disease germs appetizingly for them with a natural sauce that Sir Almroth named opsonins." (A more extended account of immunology at the turn of the nineteenth century may be found in Silverstein A.M. (2009) *A History of Immunology*, 2nd edn. Elsevier.)



Figure M11.1.2 Von Behring extracting serum using a tap. Caricature by Lustigen Blättern, 1894. Legend: "Serum direct from the horse! Freshly drawn." (Source: The Wellcome Collection, London.)

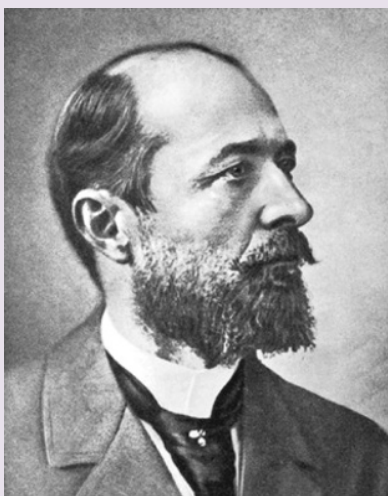


Figure M11.1.1 Emil von Behring (1854–1917). (Source: The Wellcome Collection, London.)

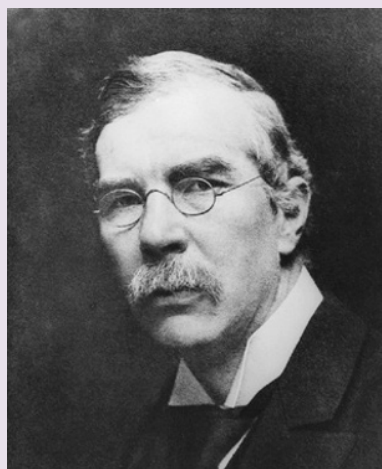


Figure M11.1.3 Sir Almroth Wright (1861–1947). (Source: The Wellcome Collection, London.)

that, on binding to terminal mannose on the bacterial surface, initiates antibody-independent complement activation. Other collectins, lung surfactant proteins SP-A and SP-D and, in cattle, conglutinin, also recognize carbohydrate ligands and can all act as opsonins (see Milestone 11.1), mediating phagocytosis by virtue of their binding to the C1q receptor.

Augmented by antibody

Encapsulated bacteria that resist phagocytosis become extremely attractive to neutrophils and macrophages when coated with antibody and their rate of clearance from the bloodstream is strikingly enhanced (Figure 11.9). The less effective removal of coated bacteria in complement-deficient animals emphasizes the synergism between antibody and complement for opsonization, which is mediated through specific receptors for immunoglobulin Fc and complement on the phagocyte surface (Figure 11.10). It is clearly advantageous that the IgG subclasses that bind strongly to the IgG Fc receptors (e.g., IgG1 and IgG3 in the human) also fix complement well, it being appreciated that C3b bound to IgG is a very efficient opsonin because it engages two receptors (FcR and CR) simultaneously. Complexes containing C3b and C4b may show immune adherence to the CR1 complement receptors on erythrocytes to provide aggregates that are extremely rapidly transported to the liver and spleen for phagocytosis.

Some elaboration on **complement receptors** may be pertinent at this stage. The **CR1** receptor (CD35) for C3b is also present on neutrophils, eosinophils, monocytes, B-cells, and lymph node follicular dendritic cells (FDCs). Together with the CR3 receptor (CD11b/CD18), it has the main responsibility for

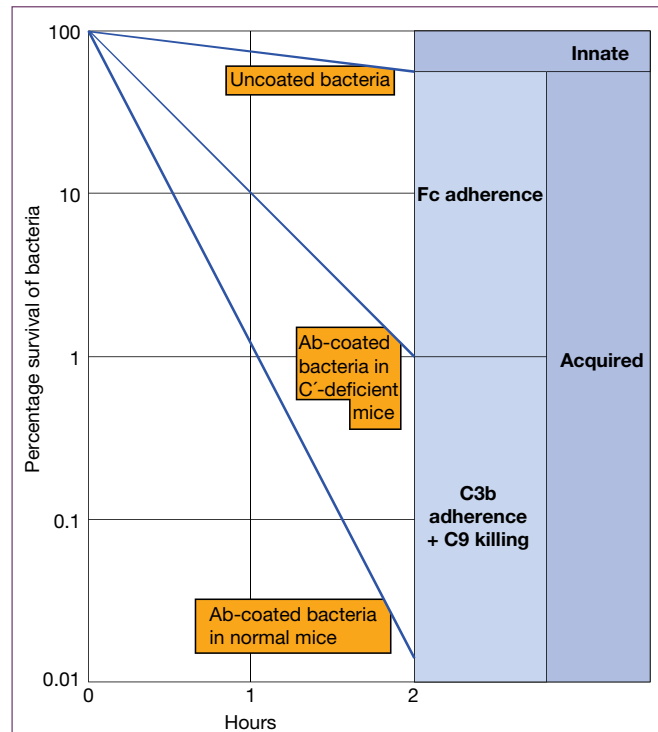


Figure 11.9 Effect of opsonizing antibody and complement on rate of clearance of virulent bacteria from the blood. The uncoated bacteria are phagocytosed rather slowly (innate immunity) but, on coating with antibody (Ab) (acquired immunity), adherence to phagocytes is increased many-fold. The adherence is less effective in complement-deficient animals. This situation is hypothetical but realistic; the natural proliferation of the bacteria has been ignored.

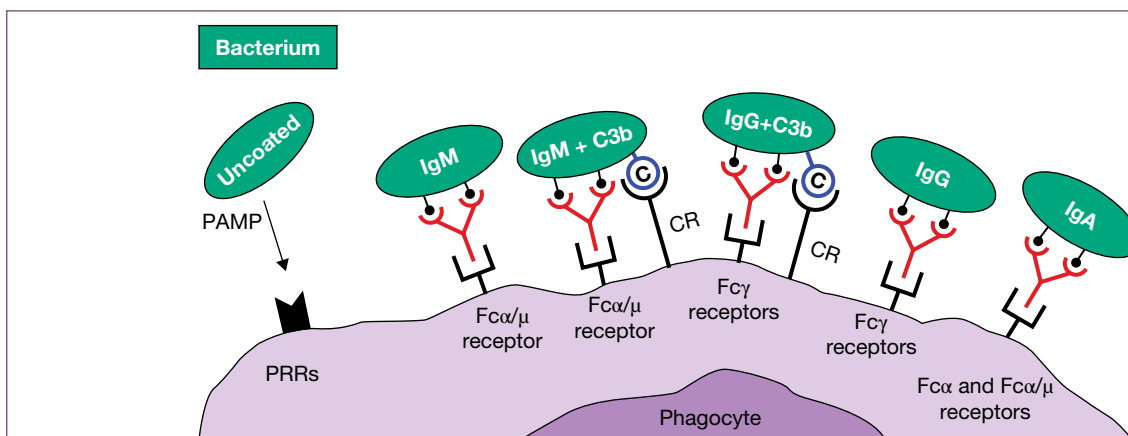


Figure 11.10 Immunoglobulin and complement greatly increase the adherence of bacteria (and other antigens) to macrophages and neutrophils. Uncoated bacteria adhere to pattern recognition receptors (PRRs) such as various Toll-like receptors (TLR) and the mannose-binding receptor. The Fc α / μ R on macrophages binds to IgM-coated bacteria. High-affinity receptors for IgG Fc and for C3b (CR1) and iC3b (CR3) on the macrophage and neutrophil surface considerably enhance the strength of binding. The augmenting effect of complement is due to the fact that two adjacent IgG molecules can fix many C3b molecules, thereby increasing the number of links to the macrophage (see “bonus effect of multivalency”). Bacteria opsonized with IgA can adhere to the phagocyte via the Fc α / μ R already mentioned, or via Fc α RI (CD89), which is present on the surface of both macrophages and neutrophils.

clearance of complexes containing C3. The genes encoding CR1, C4b-binding protein and factor H are linked in a cluster. The three proteins all serve a regulatory function by binding to C3b or C4b to disassemble the C3/C5 convertases, and act as cofactors for the proteolytic inactivation of C3b and C4b by factor I.

CR2 receptors (CD21) for iC3b, C3dg, and C3d are present on B-cells and FDCs, and transduce accessory signals for B-cell activation, especially in the germinal centers. They act as the receptor for Epstein–Barr virus (EBV), binding to the gp350 major viral envelope glycoprotein and thereby facilitate entry of the virus into B-cells, with MHC class II molecules acting as a co-receptor binding to viral gp42.

CR3 receptors (CD11b/CD18, widely expressed on leukocytes including neutrophils, eosinophils, monocytes, macrophages, and NK cells) bind iC3b, C3dg, and C3d. They are related to LFA-1 and **CR4** (CD11c/CD18, which has a similar cellular distribution to CR3 and binds iC3b and C3dg) in being members of the β_2 integrin subfamily (see Table 6.1). **CR5** is found on neutrophils and platelets and binds C3d and C3dg. A number of other complement receptors have been described including some with specificity for C1q, for C3a and C4a, and the CD88 molecule with specificity for C5a.

Immune protection of mucosal surfaces

The majority of pathogens enter the body through mucosal surfaces, whether we are talking about gastrointestinal, respiratory, or sexually transmitted infections. We have earlier emphasized the critical nature of the mucosal barriers, which provide a potentially hostile interface against these microbial hordes. With an area of around 400 m², give or take a tennis court or two, the epithelium of the adult mucosae has a complex and highly organized system of immune protection.

The gut mucosal surfaces are defended by both antigen-specific and non-antigen-specific mechanisms. Among the nonspecific mechanisms, antimicrobial peptides are produced not only by neutrophils and macrophages but also by mucosal epithelium. As described in Chapter 1, antimicrobial peptides called defensins lyse bacteria via disruption of their surface membranes. Specific immunity is provided by secretory IgA and IgM, with IgA1 predominating in the upper areas and IgA2 in the large bowel. Most other mucosal surfaces are also protected predominantly by IgA, with the exception of the reproductive tract tissues of both male and female, where the dominant antibody isotype is IgG. IgA antibodies afford protection in the external body fluids, tears, saliva, nasal secretions, and fluids bathing the surfaces of the intestine and lung. This is achieved by coating bacteria and viruses with the IgA and thereby preventing their adherence to the epithelial cells of the mucous membranes, which is essential for viral infection and bacterial colonization. Secretory IgA molecules themselves have very little innate adhesiveness for epithelial cells, but high-affinity Fc receptors for this Ig class are present on macrophages and neutrophils. These phagocytic cells are able to migrate across the gut epithelium into the gut lumen where they are able to mediate phagocytosis (Figure 11.11a).

If an infectious agent succeeds in penetrating the IgA barrier, it comes up against the next line of defense of the secretory system, which is manned by IgE. Indeed, most serum IgE arises from plasma cells in mucosal tissues and their local draining lymph nodes. Although present in low concentration, IgE is firmly bound to the Fc receptors of the mast cell and contact with antigen leads (just like the antibody-independent effect of C3a and C5a) to the release of mediators that effectively recruit agents of the immune response and generate a local acute inflammatory reaction. Thus histamine,

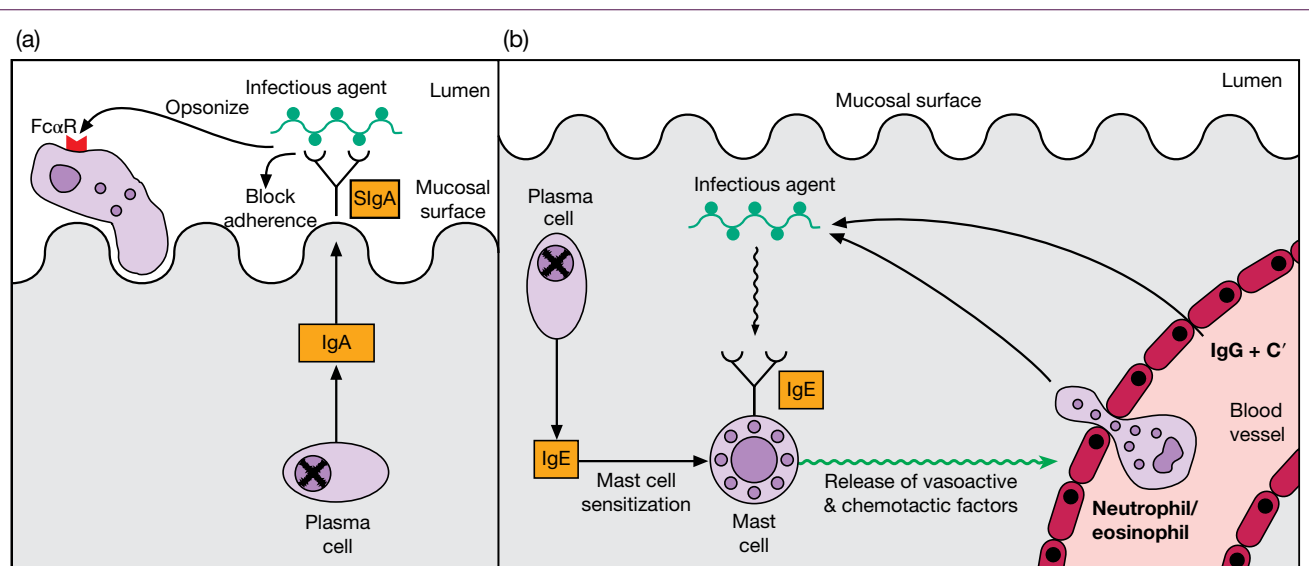


Figure 11.11 Defense of the mucosal surfaces. (a) IgA opsonizes organisms and prevents adherence to the mucosa. (b) IgE recruits agents of the immune response by firing the release of mediators from mast cells.

by increasing vascular permeability, causes the transudation of IgG and complement into the area, while chemotactic factors for neutrophils and eosinophils attract the effector cells needed to dispose of the infectious organism coated with specific IgG and C3b (Figure 11.11b). Engagement of the Fc γ and C3b receptors on local macrophages by such complexes will lead to secretion of factors that further reinforce these vascular permeability and chemotactic events. Broadly, one would say that immune exclusion in the gut is non-inflammatory, but immune elimination of organisms that penetrate the mucosa is proinflammatory.

Where the opsonized organism is too large to be engulfed, phagocytes can employ antibody-dependent cellular cytotoxicity (ADCC) and there is also evidence for its involvement in parasitic infections.

The mucosal tissues contain various T-cell populations, but their role and that of the mucosal epithelial cells, other than in a helper function for local antibody production, is of less relevance for the defense against extracellular bacteria.

Some specific bacterial infections

First let us see how these considerations apply to defense against infection by common organisms such as streptococci and staphylococci. The β -hemolytic *streptococci* were classified by Rebecca Lancefield according to their carbohydrate antigen, the most important for human disease belonging to group A. *Streptococcus pyogenes* most commonly causes acute pharyngitis (strep sore throat) and the skin condition impetigo, but is also responsible for scarlet fever and has emerged as a cause of the much rarer but often fatal toxic shock syndrome and of the always alarming necrotizing fasciitis (flesh-eating disease). Rheumatic fever and glomerular nephritis sometimes occur as serious postinfection sequelae.

The most important virulence factor is the surface M-protein (variants of which form the basis of the Griffith typing). This molecule binds the complement control protein factor H, thereby protecting the bacteria from complement-mediated damage. However, protection can be provided by antibodies to the M-protein which opsonize the bacteria for subsequent phagocytosis. The ability of group A streptococci to elicit cross-reactive autoantibodies that bind to cardiac myosin results in poststreptococcal autoimmune disease. High titer antibodies to the streptolysin O exotoxin (ASO), which damages membranes, indicate recent streptococcal infection. The streptococcal pyrogenic exotoxins SPE-A, -C, and -H, and the streptococcal mitogenic exotoxin SMEZ-2 are superantigens associated with scarlet fever and toxic shock syndrome. The toxins are neutralized by antibody and the erythematous intradermal reaction to injected toxin (the Dick reaction) is only seen in individuals lacking antibody. Antibody can also neutralize bacterial enzymes such as hyaluronidase that act to spread the infection.

The mutans streptococci (*Streptococcus mutans* and *S. sobrinus*) are an important cause of dental caries. The organisms possess

a glucosyltransferase enzyme that converts sucrose to glucose polymers (glucans), which aids adhesion to the tooth surface. Small-scale clinical trials with vaccines based upon the glucosyltransferase, usually together with components of the surface antigen I/II fibrillar adhesins, have shown that salivary IgA against mutans streptococci can be increased and, in some cases, interfere with colonization.

Virulent forms of *staphylococci*, such as *Staphylococcus aureus*, resist phagocytosis. Both staphylococci and streptococci express surface proteins that bind to the Fc region of the IgG heavy chain (protein A and protein G, respectively) and serve to limit antibody-mediated effector functions by binding the antibodies the “wrong way” round. Virulence factors encoded by *S. aureus* genes also include adhesins and cell wall teichoic acid on the surface of the bacterium, toxic shock syndrome toxin-1, enterotoxins, and enzymes. The penicillin-binding protein 2a is able to synthesize peptidoglycan even in the presence of β -lactam antibiotics. Other virulence factors are acquired from lysogenic bacteriophages, including Panton-Valentine leucocidin and chemotaxis inhibitory protein (CHIP). Although *S. aureus* is readily phagocytosed in the presence of adequate amounts of antibody, a small proportion of the ingested bacteria survives and they are difficult organisms to eliminate completely. Where the infection is inadequately controlled, severe lesions may occur in the immunized host as a consequence of type IV delayed hypersensitivity reactions. The methicillin-resistant *S. aureus* (MRSA) “superbug,” which was already resistant to all the β -lactam antibiotics, has now become vancomycin resistant following transfer of drug resistance from *Enterococcus*. New drugs such as linezolid and daptomycin can be used to treat MRSA infections but there are rare instances of resistance developing to these antibiotics as well – pretty scary stuff.

Other examples where antibodies are required to overcome the inherently antiphagocytic properties of *bacterial capsules* are seen in immunity to pneumococci, meningococci, and *Haemophilus influenzae*. *Bacillus anthrax* possesses an antiphagocytic capsule composed of a γ -polypeptide of D-glutamic acid but, although anticapsular antibodies effectively promote uptake by neutrophils, the exotoxin is so potent that vaccines are inadequate unless they also stimulate antitoxin immunity. In addition to releasing such lethal exotoxins, *Pseudomonas aeruginosa* also produces an elastase that inactivates C3a and C5a; as a result, only minimal inflammatory responses are made in the absence of neutralizing antibodies.

The ploy of *diverting complement activation* to insensitive sites is seen rather well with different strains of Gram-negative salmonella and *E. coli* organisms that vary in the number of O-specific oligosaccharide side-chains attached to the lipid-A-linked core polysaccharide of the endotoxin (see Figure 11.5). Variants with long side-chains are relatively insensitive to killing by serum through the alternative complement pathway; as the side-chains become shorter and shorter, the serum sensitivity increases. Although all variants activate the alternative pathway, only those with short or no side-chains

allow the cytotoxic membrane attack complex to be inserted near to the outer lipid bilayer. On the other hand, antibodies focus the complex to a more vulnerable site.

The efficient destruction of gonococci is dependent upon the formation of the membrane attack complex, and rare individuals lacking C8 or C9 are susceptible to *neisseria* infection. *N. gonorrhoeae* (gonococci) specifically binds complement proteins and prevents their insertion in the outer membranes. IgA and IgG produced in the genital tract in response to these organisms inhibits the attachment of the bacteria, through their pili, to mucosal cells, but is unable to afford adequate protection against reinfection. This is at least partly due to a very effective antigenic shift mechanism that alters the sequence of the expressed pilin by gene conversion. With regard to T-cells, gonococcal colony opacity-associated (Opa) proteins bind to the immunoreceptor tyrosine-based inhibitory motif (ITIM)-containing long tail isoform of CD66a on CD4⁺ T-cells and thereby inhibit their activation and proliferation. Failure to achieve good protection might also be a reflection of the ability of the gonococci to produce a protease that cleaves a proline-rich sequence present in the hinge region of IgA1 (but not of IgA2), although the presence in most individuals of neutralizing antibodies against this protease may interfere with its proteolytic activity. Meningococci, which frequently infect the nasopharynx, *H. influenzae* and *Streptococcus pneumoniae* have similar IgA1 proteases.

Cholera is caused by the colonization of the small intestine by *Vibrio cholerae* and the subsequent action of its enterotoxin. The B subunits of the toxin bind to GM1 monosialoganglioside receptors and translocate the A subunit across the membrane where it activates adenyl cyclase. The resulting increase in cAMP then causes fluid loss by inhibiting uptake of sodium chloride and stimulating active Cl⁻ secretion by intestinal epithelial cells. Locally synthesized IgA antibodies against *V. cholerae* lipopolysaccharide and the toxin provide independent protection against cholera, the first by inhibiting bacterial adherence to the intestinal wall, the second by blocking attachment of the toxin to its receptor. In accord with this analysis are the epidemiological data showing that infants fed breast milk containing high titers of IgA antibodies specific for either of these antigens are less likely to develop clinical cholera.

The ways in which antibody can help overcome the different facets of bacterial invasion are summarized in Figure 11.12.

The habitat of intracellular bacteria allows avoidance of many of the host defenses

A number of bacterial species have evolved to reside inside the host's cells. Here they are hidden from many of the defenses, such as phagocytosis, antibodies, and complement, that the immune system regularly employs against pathogens. However, all is not lost because the host has a number of strategies that it can use to deal with such bacteria, including various cell-mediated responses.

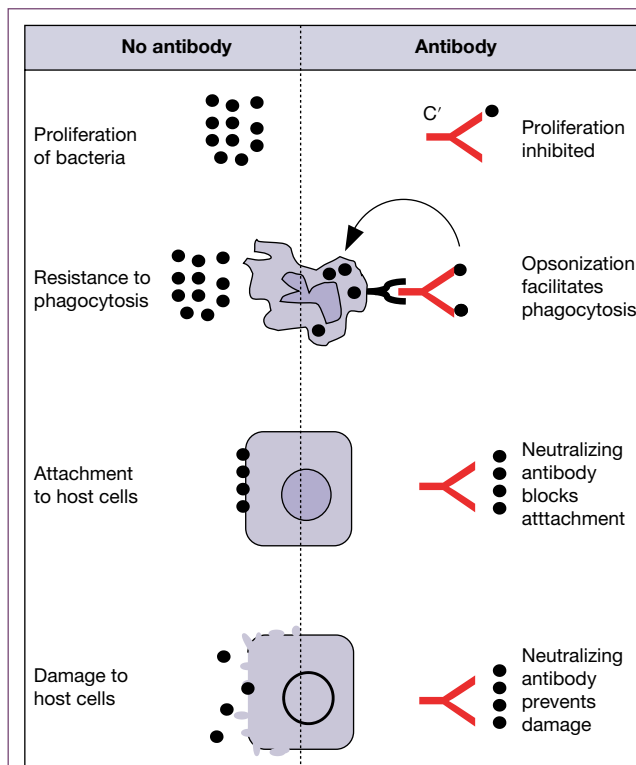


Figure 11.12 Antibody defenses against bacterial invasion.

Antibodies are able to prevent the proliferation of bacteria by, for example, blocking metabolic transport mechanisms such as receptors for iron-chelating compounds and by activating complement. Resistance to phagocytosis can be overcome by opsonizing the bacteria for subsequent recognition by Fc receptors on neutrophils and macrophages. The production of antibodies against fimbriae, lipoteichoic acid, and capsules can prevent attachment of bacteria to host cells. Neutralizing antibodies to bacterial toxins can prevent damage to host cells.

Bacterial survival strategies

Yersinia and *Salmonella* are among the select number of bacterial pathogens that have evolved special mechanisms to enter, survive, and replicate within normally **nonphagocytic host cells**. The former gains entry through binding of its outer membrane protein, invasins, to multiple β_1 -integrin receptors on the host cell. For *Salmonella* a number of bacterial proteins including salmonella invasion protein A (SipA) and the salmonella outer proteins SopA, SopB, SopD, and SopE₂ stimulate events such as cytoskeletal rearrangements and membrane ruffling to facilitate entry into host cells.

Some strains of bacteria, such as the tubercle and leprosy bacilli and listeria and brucella organisms, escape the wrath of the immune system by cheekily fashioning an intracellular life within one of its strongholds, the **phagocytic macrophage** no less. Mononuclear phagocytes are a good target for such organisms in the sense that they are very mobile and allow wide dissemination throughout the body. Entry of bacteria is facilitated by phagocytic uptake after attachment to pattern

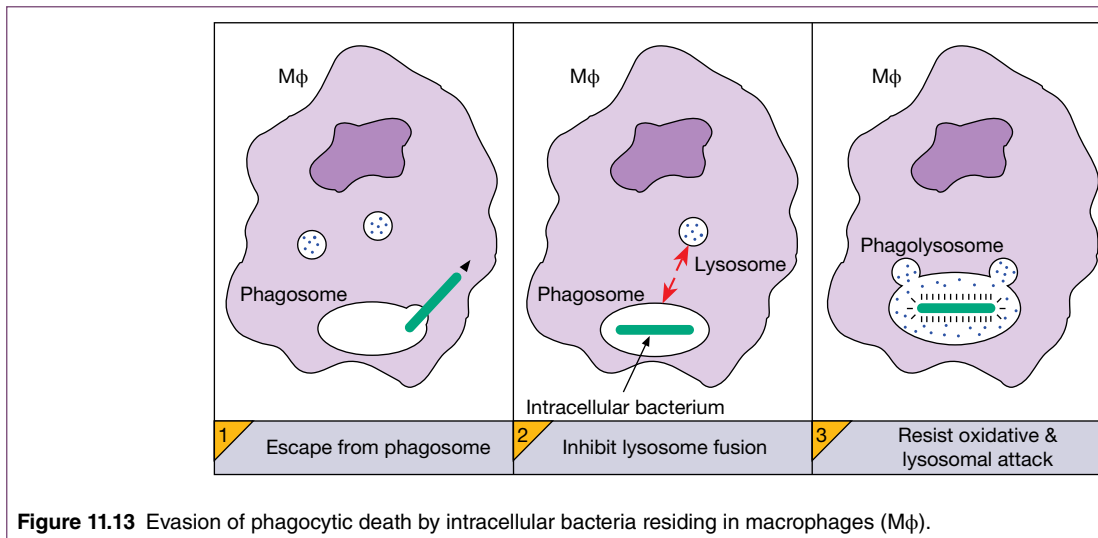


Figure 11.13 Evasion of phagocytic death by intracellular bacteria residing in macrophages (M ϕ).

recognition receptors and, following opsonization, to Fc γ and C3b receptors. Once inside, many of them defy the mighty macrophage by subverting their killing mechanisms in a variety of ways. Organisms such as *Mycobacterium tuberculosis* neutralize the pH in the phagosome and inhibit subsequent fusion with the lysosomes (Figure 11.13). Mycobacterial cell wall peptidoglycan and glycolipids, such as lipoarabinomannan, inhibit macrophage activation. *Listeria monocytogenes* uses a lysin, listeriolysin O, to escape from its phagosomal prison to lie happily free within the cytoplasm; some rickettsiae (and the protozoan *Trypanosoma cruzi*) can do the same using other lysins. Certain bacteria, although primarily extracellular in habit, can invade nonphagocytic cells. An example is *Helicobacter pylori*, which is able to reside in epithelial cells that then serve as a reservoir for reinfection.

Defense against intracellular bacteria needs to recruit T-cell-mediated immunity

In an elegant series of experiments, George Mackaness demonstrated the importance of T-cell-mediated immunity (CMI) reactions for the killing of intracellular bacteria and the establishment of an immune state. Animals infected with moderate doses of *M. tuberculosis* overcome the infection and are immune to subsequent challenge with the bacillus. The immunity can be transferred to a normal recipient with T-lymphocytes but not macrophages or serum from an immune animal. Supporting this view, that specific immunity is mediated by T-cells, is the greater susceptibility to infection with tubercle and leprosy bacilli of mice in which the T-lymphocytes have been depressed by thymectomy plus anti-T-cell monoclonals, or in which the TCR genes have been disrupted by homologous gene recombination (knockout mice).

Activated macrophages kill intracellular parasites

When monocytes first settle down in the tissue to become “resident” macrophages they are essentially in a resting state with minimal microbicidal capability. However, the development of

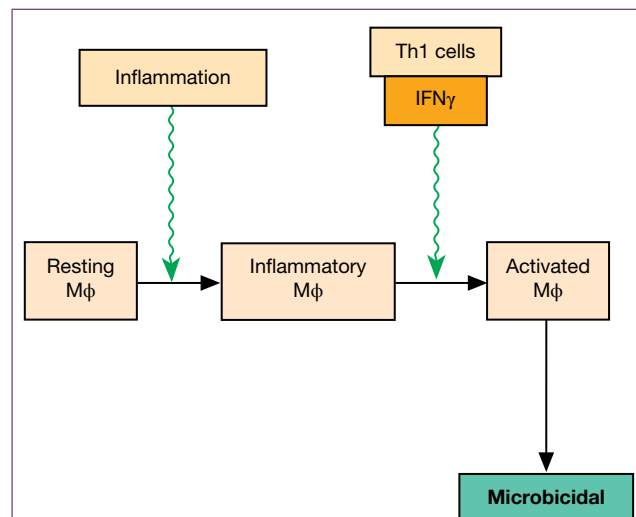


Figure 11.14 Stages in the activation of macrophages (M ϕ) for microbicidal function. Macrophages taken from sites of inflammation are considerably increased in size, acid hydrolase content, secretion of neutral proteases, and phagocytic function. For example, the C3b receptors on resident resting M ϕ are not freely mobile in the membrane and so cannot permit the “zippering” process required for phagocytosis; consequently, they bind but do not ingest C3b-coated red cells. Inflammatory M ϕ , on the other hand, have C3 receptors that display considerable lateral mobility and the C3-opsonized erythrocytes are readily phagocytosed. In addition to the dramatic upregulation of intracellular killing mechanisms, striking changes in surface components accompany the activation that occurs in response to Th1 cytokines such as IFN γ .

an inflammatory environment will partially activate them and the subsequent recruitment of pathogen-specific Th1 cells will lead to full activation. The production of macrophage-activating factors such as the cytokines IFN γ , TNF, and lymphotoxin by these Th1 cells results in the macrophages now being able to kill obligate intracellular microbes (Figure 11.14). Foremost among the killing mechanisms that are upregulated are those mediated

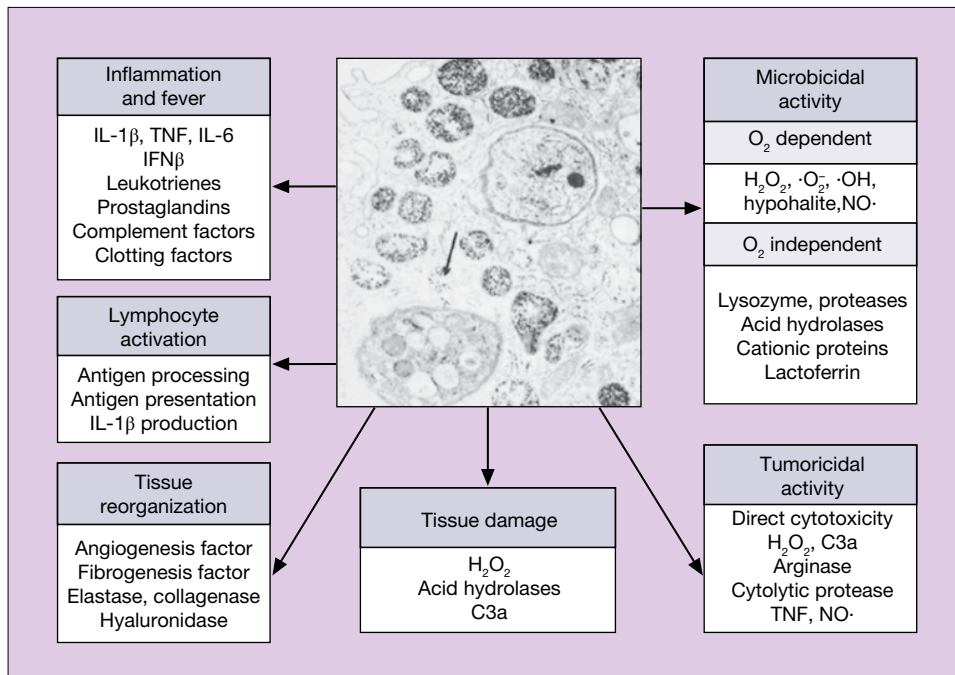


Figure 11.15 The role of the activated macrophage in the initiation and mediation of chronic inflammation with concomitant tissue repair, and in the killing of microbes and tumor cells. It is possible that macrophages differentiate along distinct pathways to subserve these different functions. The electron micrograph shows a highly activated macrophage with many lysosomal structures that have been highlighted by the uptake of thorotrast; one (arrowed) is seen fusing with a phagosome containing the protozoan *Toxoplasma gondii*. (Source: C. Jones. Reproduced with permission.)

by reactive oxygen intermediates and $\text{NO}\cdot$ radicals. The activated macrophage is undeniably a formidable cell, capable of secreting the 60 or so substances that are concerned in chronic inflammatory reactions (Figure 11.15) – not the sort to meet in an alley on a dark night!

The mechanism of T-cell-mediated immunity in the Mackness experiments now becomes clear. Specifically primed T-cells react with processed antigen derived from the intracellular bacteria present on the surface of the infected macrophage in association with MHC class II; the subsequent release of cytokines activates the macrophage and endows it with the ability to kill the organisms it has phagocytosed (Figure 11.16).

Examples of intracellular bacterial infections

Listeria

The organism *Listeria monocytogenes*, usually acquired by humans following the ingestion of contaminated foods such as unpasteurized dairy products, poses a particular risk to pregnant women because of its association with septic abortion (i.e., a miscarriage [or an interventional abortion] linked to uterine infection). Following interaction of the bacterial cell surface molecule internalin A with E-cadherin on the epithelial cells, the organism passes through the epithelium and enters the bloodstream. Dissemination occurs to the spleen and liver where phagocytic internalization into macrophages occurs, and

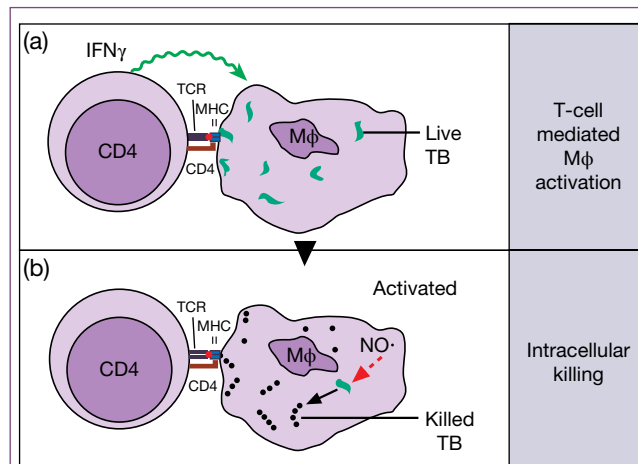


Figure 11.16 The “cytokine connection”: nonspecific murine macrophage killing of intracellular bacteria triggered by a specific T-cell-mediated immunity reaction. (a) Specific CD4 Th1 cell recognizes mycobacterial peptide associated with MHC class II and releases macrophage (M ϕ) activating $\text{IFN}\gamma$. (b) The activated M ϕ kills the intracellular TB, mainly through generation of toxic $\text{NO}\cdot$.

into hepatocytes via binding of another microbial surface molecule, internalin B, to the hepatocyte growth factor receptor. $\text{IFN}\gamma$ secreted by NK and Th1 cells drives the macrophage activation required for the ultimate elimination of intracellular

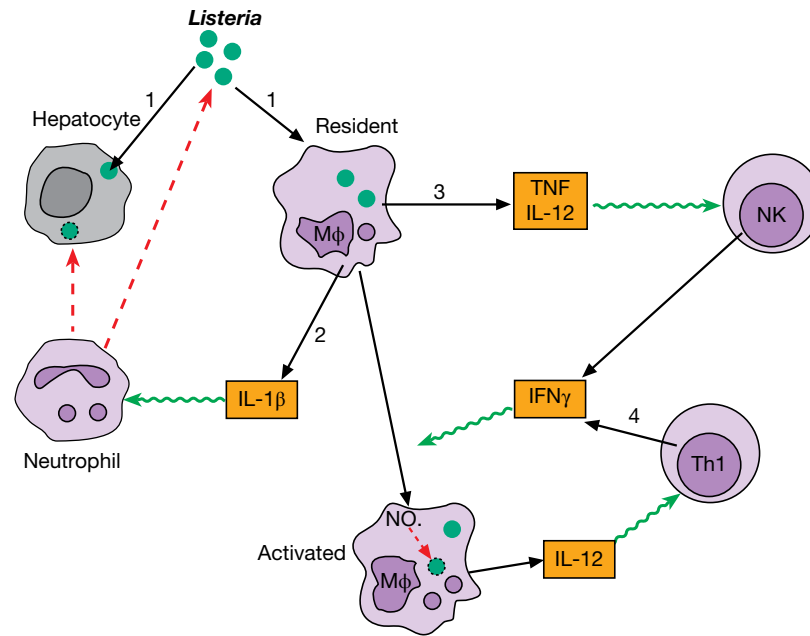


Figure 11.17 Macrophage activation in response to *Listeria* infection. (1) *Listeria* infects resident macrophages and hepatocytes; (2) the Mφ release IL-1β, which activates neutrophils to destroy *Listeria* bacilli by direct contact and are cytotoxic for infected hepatocytes; (3) the infected Mφ release TNF and IL-12, which stimulate NK cells to secrete IFNγ, which in turn activates the macrophage to produce NO and kill intracellular *Listeria*; IFNγ plus Mφ-derived IL-12 recruit Th1 cells, which reinforce Mφ activation through the production of IFNγ (4). (Data source: Rogers H.W. *et al.* (1995) *The Immunologist* 3, 152.)

Listeria (Figure 11.17) The bactericidal action of neutrophils and the central role of IL-12 also warrant our attention, as does the recruitment by the chemokine CCL2 (MCP-1) of dendritic cells producing TNF and nitric oxide. These or other populations of dendritic cells are thought to cross-prime CD8⁺ T-cells with listeria antigens derived from infected macrophages. During primary infection, CD8 T-cells that are restricted to the nonclassical MHC molecule H2-M3 seem to play a particularly important role, whereas the classical class I restricted CD8 T-cells make a more profound contribution during secondary infection. Mutant mice lacking αβ and/or γδ T-cells reveal that these two cell types make comparable contributions to resistance against primary listeria infection, but that the αβ TCR set bears the major responsibility for conferring protective immunity. γδ T-cells control the local tissue response at the site of microbial replication and γδ knockout mutants develop huge abscesses when infected with *Listeria*.

Tuberculosis

Tuberculosis (TB) is on the rampage, aided by the emergence of multidrug-resistant strains of *Mycobacterium tuberculosis*. It is estimated that 1.5 million deaths worldwide resulted from TB in 2014. This figure includes approximately 390 000 people with AIDS who died of tuberculosis – indeed TB is the leading killer of HIV-infected individuals, accounting for approximately 25% of all deaths in this group.

With respect to host defense mechanisms, as seen with listeria infection, *murine* macrophages activated by IFNγ can destroy intracellular mycobacteria, largely through the generation of toxic NO· radicals. *M. tuberculosis* within the macrophage can be engulfed by autophagy in these cells, with subsequent fusion to lysosomes containing a variety of microbicidal compounds. Some infected macrophages reach a stage at which they are too incapacitated to be stirred into action by T-cell messages, and here a somewhat ruthless strategy has evolved in which the host deploys cytotoxic CD8, and possibly CD4 and NK cells, to execute the helpless macrophage and release the live mycobacteria; these can now be taken up by newly immigrant phagocytic cells susceptible to activation by IFNγ and summarily disposed of (Figure 11.16). A vital role for both αβ and γδ T-cells in murine TB is indicated by an inability to control the infection in both TCR β-chain knockout mice (which lack an αβ TCR) and TCR δ-chain knockout mice (which lack a γδ TCR).

Inbred strains of mice differ dramatically in their susceptibility to infection by various mycobacteria. Resistance is associated with a T-cell-independent enhanced state of macrophage priming for bactericidal activity involving oxygen and nitrogen radicals. Moreover, macrophages from resistant strains have increased MHC class II expression and a higher respiratory burst, are more readily activated by IFNγ, and induce better stimulation of T-cells. By contrast, macrophages from susceptible strains tend to have suppressor effects on T-cell proliferation

to mycobacterial antigens. The *M. tuberculosis*-infected macrophages secrete IL-6, which has the property of inhibiting IFN γ signaling in the surrounding macrophages. Susceptibility and resistance to *M. tuberculosis* in murine models depend upon a number of genes, including *SLC11A1* (solute carrier family 11 member 1, a proton-coupled divalent metal ion transporter previously called Nramp1) and genes in the *sst1* gene locus (supersusceptibility to tuberculosis 1, also involved in macrophage defense mechanisms against a diverse range of intracellular pathogens including *Listeria monocytogenes* and *Chlamydia pneumoniae*). A number of polymorphisms have been identified in the human *SLC11A1* gene and studies are ongoing to link individual polymorphisms to susceptibility.

Where the host has difficulty in effectively eliminating these organisms, the chronic CMI response to local antigen is driven by the release of cytokines including TNF and various chemokines. Densely packed macrophages accumulate, release angiogenic and fibrogenic factors and stimulate the formation of granulation tissue (newly developed connective tissue and capillaries) and ultimately fibrosis (excess fibrous connective tissue). The activated macrophages transform to epithelioid cells and fuse to become giant cells. As suggested earlier, the resulting granuloma represents an attempt by the body to isolate a site of persistent infection.

The position is complicated in the *human* because IFN γ -stimulated human macrophages are unable to completely eliminate intracellular TB. Detection of the triacylated lipoprotein PAMP of *M. tuberculosis* by the TLR1/TLR2 heterodimer stimulates macrophage production of proinflammatory cytokines such as IL-1 β , inducible NO synthase, and expression of co-stimulatory molecules. Furthermore, the intracellular pattern recognition receptor NOD2 recognizes the mycobacterial peptidoglycan muramyl dipeptide, again resulting in the production of proinflammatory cytokines. However, interference with the phagosome and a resistance to macrophage killing enable survival of the mycobacteria, and thus the potential for them to escape from the granuloma at some future time point.

The mycobacterial products Ag85B (a mycolyl transferase) and ESAT-6 (early secreted antigenic target-6) are potent inducers of IFN γ from human CD4⁺ T-cells. In addition, CD8⁺ T-cells can recognize mycobacterial peptide antigens presented by MHC class I. $\alpha\beta$ T-cells have been described that proliferate in response to mycobacterial lipid-bearing antigens such as didehydroxymycobactins presented by host CD1a molecules and mycolic acid presented by CD1b. Although *in vitro* these cells can secrete IFN γ and TNF and can be cytotoxic, their function *in vivo* remains unclear. Regarding $\gamma\delta$ T-cells, in the human those with a V γ_2 V δ_2 TCR recognize protein antigens, isopentenyl pyrophosphates, and prenyl pyrophosphates from *M. tuberculosis*, but again any possible protective role *in vivo* remains speculative.

Leprosy

Human leprosy presents as a spectrum ranging from the *tuberculoid* form, with lesions containing small numbers of viable organisms, to the *lepromatous* form, characterized by an

abundance of *Mycobacterium leprae* within the macrophages. CMI rather than humoral immunity is important for the control of the leprosy bacillus. Although the tuberculoid state is associated with good cell-mediated dermal hypersensitivity reactions and a bias towards Th1-type responses, these are still not good enough to eradicate the bacilli completely. In the lepromatous form, there is poor T-cell reactivity to whole bacilli and poor lepromin (an extract of inactivated bacilli) dermal responses, although there are numerous plasma cells that contribute to a high level of circulating antibody and indicate a more prominent Th2 activity. Leukocyte Ig-like receptor-A2 (LILRA2) expression is increased in lesions of lepromatous patients, causing a block in TLR-directed antimicrobial activity and a reduced production of proinflammatory IL-12, but enhanced secretion of immunosuppressive IL-10, by monocytes.

Virus survival strategies

When outside of cells, viruses are surrounded by a protein coat – the capsid. In the case of enveloped viruses the capsid is enclosed by a lipid bilayer that, although derived from the host cell membrane, also incorporates viral proteins required for cell attachment. However, all viruses have to spend some of their life cycle inside host cells. They have no choice in this matter as they do not themselves possess all the components necessary to replicate their nucleic acid. During its extracellular existence the virus is susceptible to neutralization by antibodies able to block binding to receptors on the host cells; it can be engulfed and destroyed by phagocytes and can be damaged by the effects of complement (e.g., by opsonization for phagocytosis or by lysis of enveloped viruses). However, like the intracellular bacteria discussed above, once inside the host cell the virus is effectively hidden from many host responses. Furthermore, many viruses cause latent infections in which the viral genome is in an inactive state inside host cells. Only upon reactivation will viral proteins be produced that can be processed for presentation by MHC class I molecules to CD8⁺ cytotoxic T-cells with subsequent destruction of the infected cell. This will deprive the virus of its habitat and any viruses released from the killed cell will become accessible to the combined effects of phagocytic cells, antibody, and complement. Although this is a rather brutal approach in that it involves us killing our own cells, so long as it happens reasonably early on in the infection it is no big deal as we can usually replace the destroyed cells. However, during chronic viral infections the destruction of our own cells by cytotoxic T-cells can become so extensive that the immune response causes more damage than the virus itself, leading to immunopathology.

Viruses constitute a formidable enemy

HIV and influenza virus, among others, can quickly change their antigens by genetic mutation. Other viruses seem to come at us out of nowhere. Take the severe acute respiratory syndrome (SARS) caused by the SARS-associated coronavirus

(SARS-CoV). This virus emerged as a human infection in Guangdong province in China in November 2002, almost certainly arising from one of the related coronaviruses found in a number of animal species. It spread rapidly to Hong Kong, and then on to Beijing, Hanoi, and Singapore. Shortly afterwards it was taken to Toronto by an infected traveler. Fortunately the infection was swiftly brought under control by isolating infected individuals and tracing their contacts, and the chain of transmission was broken by July 2003. According to World Health Organization figures, 8098 people became ill in 26 countries and 774 of these died. Hardly worth mentioning compared with the over 4500 deaths per day from HIV infection, but nevertheless the brief SARS epidemic had a substantial economic effect, particularly in East Asia, and it is impossible to predict if and when there will be a future SARS outbreak.

Viruses essentially have to overcome four layers of defense; (i) the outer physical and chemical barriers of the body, (ii) intrinsic antiviral factors, (iii) innate immunity, and (iv) adaptive immunity. A group of intrinsic antiviral proteins referred to as **restriction factors** are collectively able to block each stage of the viral life cycle; entry, uncoating, replication, translation, assembly and release. For example, the TRIM5 α (tripartite interaction motif 5 α) protein targets the retroviral capsid in monkey cells and is responsible for the inability of HIV-1 to infect cells from most nonhuman primates. The APOBEC3 cytidine deaminases also act as restriction factors, in this case by hypermutating the retroviral genome. However, viruses have evolved a wide range of survival strategies to overcome the host response, including direct targeting of the restriction factors and inhibition of innate and adaptive responses.

Macrophages may readily take up viruses nonspecifically and kill them. However, in some instances, the macrophages allow replication and, if the virus is capable of producing cytopathic effects in vital organs, the infection may be lethal; with noncytopathic agents, such as lymphocytic choriomeningitis, Aleutian mink disease, and equine infectious anemia viruses, a persistent infection may result. Viruses can avoid recognition by the host's immune system by latency or by sheltering in privileged sites, but they have also evolved a maliciously cunning series of evasive strategies.

Immunity can be evaded by antigenic changes

Influenza viruses change antigens by drift and shift

In the course of their constant duel with the immune system, viruses are continually changing the structure of their surface antigens. For example, the influenza A virus uses processes termed “antigenic drift” and “antigenic shift” to alter its hemagglutinin (H) and neuraminidase (N) surface antigens. Hemagglutinin is used by the virus for adhesion to host cells prior to infection, and neuraminidase releases newly formed virus from the surface sialic acid of the infected cell; of these, the hemagglutinin is the more important for the establishment

of protective immunity. Minor changes in antigenicity of these antigens occur through point mutations in the viral genome (*drift*), but major changes (*shift*) arise through wholesale swapping of genetic material with reservoirs of different viruses in other animal hosts such as avian species (e.g., chickens, turkeys, and ducks) and pigs (Figure 11.18). When alterations in the hemagglutinin are sufficient to render previous immunity ineffective, new influenza pandemics break out, as occurred in 1888, 1918, 1957, and 1968 following antigenic shifts in the influenza A virus. In 1997, the avian H5N1 virus infected humans in Hong Kong and is now in circulation across much of the globe and proving fatal in some cases. There has since been a number of other avian influenza viruses causing illness or occasionally death in humans, including H9N2 in Hong Kong in 1999 and 2003, H7N7 in the Netherlands in 2003, and H7N3 in Canada in 2004. In June 2009 the World Health Organization declared the emergence of a worldwide pandemic due to a novel strain of H1N1 that had originated in swine. Fortunately the mortality rate associated with this virus was far lower than many had feared, although we may not be so lucky next time around.

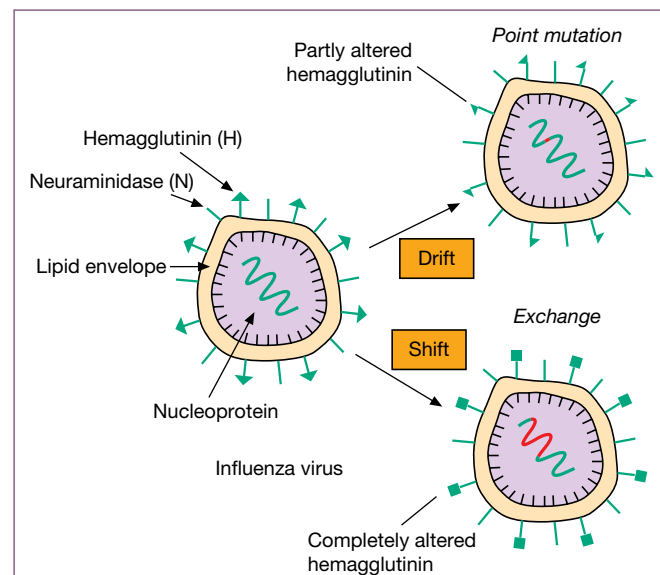


Figure 11.18 Antigenic drift and shift in influenza virus. The changes in hemagglutinin structure caused by drift may be small enough to allow protection by immunity to earlier strains. This may not happen with radical changes in the antigen associated with antigenic shift and so new virus epidemics break out. There have been 32 documented influenza pandemics (widespread epidemics occurring throughout the population) since the first well-described pandemic of 1580. From 1900 onwards there have been four, associated with the emergence by antigenic shift of the Spanish flu in 1918 with the structure H1N1 (the official nomenclature assigns numbers to each hemagglutinin and neuraminidase major variant), Asian flu in 1957 (H2N2), Hong Kong flu in 1968 (H3N2), and “swine flu” in 2009 (another H1N1 variant). Note that each new pandemic was due to a fundamental change in the hemagglutinin. The pandemic in 1918 killed an estimated 40 million people.

Rhinovirus – the common cold virus

Mutated viruses can be favored by selection pressure from antibody. In fact, one current strategy for generating mutants in a given epitope is to grow the virus in tissue culture in the presence of a monoclonal antibody that reacts with that epitope; only mutants that do not bind the monoclonal will escape and grow out. This principle underlies the antigenic variation characteristic of the common cold rhinoviruses. The site on the virus for attachment to the viral receptor ICAM-1 on mucosal cells is a hydrophobic pocket lying on the floor of a canyon. Following binding, ICAM-1 catalyzes the penetration of the virus by forcing the viral capsid into an expanded open state with subsequent release of viral RNA. Antibodies produced in response to rhinovirus infection are too large to penetrate the viral canyon and they react instead with the rim of the canyon. Mutations in the rim would thus enable the virus to escape from the host immune response without affecting the conserved site for binding to the target cell. However, some neutralizing monoclonal antibodies have been identified

that contact a significant proportion of the canyon directly overlapping with the ICAM-1-binding site.

Mutation can produce nonfunctional T-cell epitopes

A number of viruses, including hepatitis B and C viruses and HIV, are capable of making mutations that prevent stimulation of cytotoxic T-cells. Such mutations modify residues that could contribute to peptides able to bind to MHC or be subsequently recognized by the TCR.

Some viruses interfere with antigen processing and/or presentation

Virtually every step in antigen processing and subsequent presentation by MHC class I to cytotoxic T-cells can be sabotaged by one virus or another (Figure 11.19). Human cytomegalovirus (HCMV) is particularly adept at this, producing a whole gamut of proteins that interfere with antigen processing and

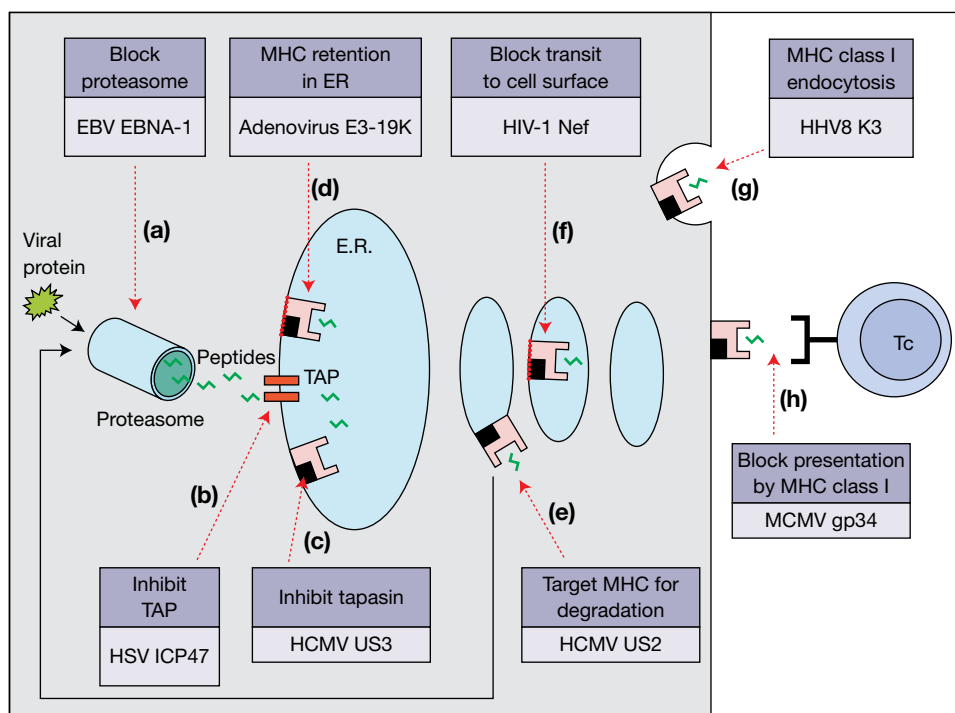


Figure 11.19 Viral interference with antigen processing and presentation by MHC class I. Many viruses have evolved ways of avoiding detection by CD8⁺ cytotoxic T-cells, and here we provide just a few examples from among the many strategies that are employed. (a) The Epstein–Barr virus (EBV) nuclear antigen-1 (EBNA-1) contains glycine–alanine repeats that inhibit proteasome-mediated processing of viral proteins. (b) Peptide binding to TAP is inhibited by the infected cell protein 47 (ICP47) of herpes simplex virus (HSV). (c) Human cytomegalovirus (HCMV) produces a protein, US3, that inhibits tapasin (not shown), an essential component of the peptide-loading complex. (d) The E3–19K protein of adenovirus causes retention of MHC class I molecules in the endoplasmic reticulum (E.R.). (e) Redirection of the class I molecules to the cytosol for degradation by the proteasome is the very sneaky ploy of the HCMV US2 protein. (f) The Nef protein of HIV-1 causes retention of MHC class I molecules in the Golgi apparatus with subsequent targeting to lysosomes. (g) Even if it makes it to the cell surface, the MHC class molecule is not safe. The K3 protein of Kaposi's sarcoma-associated human herpesvirus 8 (HHV8) can remove it from the cell surface by a process involving endocytosis and ubiquitination. (h) The gp34 protein of murine CMV interferes with recognition of the peptide–MHC complex by the TCR on the CD8⁺ cytotoxic T-cell.

presentation. The MHC class II pathway is not exempt from viral interference. HIV Nef affects vesicle traffic and endocytic processing involved in the generation of peptides, and the E1A protein of adenovirus interferes with IFN γ -mediated upregulation of MHC class II expression.

Viruses can interfere with immune effector mechanisms

Playing games with the host's humoral responses

Just as bacteria possess proteins capable of binding the Fc region of antibody, so certain viruses also possess such molecules. Herpes simplex virus (HSV) types 1 and 2, pseudorabies virus, varicella zoster virus, and murine cytomegalovirus all bear proteins that, by binding antibody “the wrong way round,” may inhibit Fc-mediated effector functions.

As we saw for bacteria, viruses can block complement-mediated induction of the inflammatory response and thereby prevent destruction of the virus. The vaccinia virus complement control protein (VCP) binds C3b and C4b, making both the classical and lectin C4b2a as well as the alternative C3bBbC3 convertases susceptible to factor I-mediated destruction. For its part, herpes simplex type 1 subverts the complement cascade by virtue of its surface glycoprotein C that binds C3b, interfering with its interaction with C5 and properdin.

Epstein-Barr virus (EBV) infects B-cells by the high-affinity binding of its gp350/220 envelope glycoprotein to the CR2 complement receptor. Members of the regulators of complement activation (RCA) family are also used as cellular receptors for various viruses, such as CD46 (membrane cofactor protein) by measles virus and human herpesvirus 6 (HHV6), and CD55 (decay accelerating factor) by echoviruses and coxsackieviruses. Ominously, HIV coated with antibody and complement can be more virulent than unopsonized virus. Antibodies that mediate this effect are, for obvious reasons, referred to as “enhancing antibodies.”

Cell-mediated immunity can also be manipulated

Parainfluenza virus type 2 strongly inhibits Tc cell function by downregulating granzyme B expression. Viral homologs of host cytokines and their receptors act as immunosuppressants. The EBV protein BCRF1 (vIL-10) has an 84% homology to human IL-10 and helps the virus to escape the antiviral effects of IFN γ by downregulating Th1 cells. Poxviruses encode soluble homologs of both the IFN α/β receptor and the IFN γ receptor, thereby competitively inhibiting the action of all three interferons. Human orthopoxvirus produces an IL-18-binding protein (IL-18BP) that inhibits IL-18-induced IFN γ production and NK responses. Herpesviruses and poxviruses possess several genes encoding chemokine-like and chemokine receptor-like proteins that can subvert the action of numerous chemokines. The list just goes on and on. Anti-IFN strategies are particularly abundant, with many viruses producing

proteins able to block IFN-induced JAK/STAT pathway activation. A prime viral target is also the activation of the double-stranded RNA-dependent protein kinase (PKR) and other components of the cell involved in setting up an antiviral state following exposure to IFN. When the African swine fever virus (ASFV) infects macrophages, its A238L protein inhibits both NF κ B and calcineurin-dependent cell activation pathways. The ASFV genome also encodes a homolog of the CD2 antigen (vCD2) that interferes with lymphocyte function.

Apoptosis of a cell could be considered bad news for a virus living very comfortably inside that cell. Therefore it is yet again not surprising that viruses have come up with ways of preventing apoptosis. Just a couple of examples: HHV8 produces a viral FLICE-inhibitory protein (vFLIP) that is a homolog of the prodomain of caspase-8 and thereby protects cells against apoptosis, whereas ASFV produces homologs of IAP (inhibitor of apoptosis) and Bcl2 in order to inhibit apoptosis. By contrast, some viral proteins including HIV-1 Vpr and HBV HBx are proapoptotic, in this case perhaps aiding dissemination of virus particles.

The host counterattack against viruses

Protection by serum antibody

Antibodies can neutralize viruses by a variety of means. They may stereochemically inhibit combination with the receptor site on cells, thereby preventing penetration and subsequent intracellular multiplication, the protective effect of antibodies to influenza hemagglutinin providing a good example. Similarly, antibodies to the measles hemagglutinin prevent entry into the cell, and the spread of virus from cell to cell is stopped by antibodies to the fusion antigen. Antibody may destroy a free virus particle directly through activation of the classical complement pathway or produce aggregation, enhanced phagocytosis, and subsequent intracellular death by the mechanisms already discussed. As far as any antibody-mediated effects are concerned, once infected the cells will need to rely upon ADCC, as has been reported with herpes, vaccinia, and mumps infection.

The most clear-cut protection by antibody is seen in diseases with long incubation times where the virus has to travel through the bloodstream before it reaches the tissue that it finally infects. For example, in poliomyelitis, the virus gains access to the body via the gastrointestinal tract and eventually passes through the circulation to reach the brain cells that become infected. Within the blood, the virus is neutralized by quite low levels of specific antibody, while the prolonged period before the virus infects the brain allows time for a secondary immune response in a primed host.

Local factors

With other viral diseases, such as influenza and the common cold, there is a short incubation time, related to the fact that the final target organ for the virus is the same as the portal of entry.

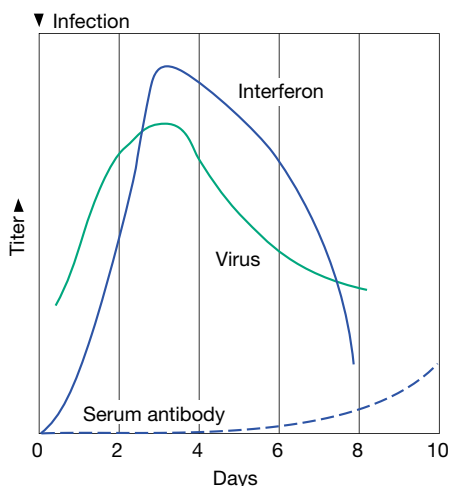


Figure 11.20 Appearance of interferon and serum antibody in relation to recovery from influenza virus infection of the lungs of mice. (Adapted from Isaacs A. (1961) *New Scientist* 11, 81.)

There is little time for a primary antibody response to be mounted and in all likelihood the **rapid production of interferon** is the most significant mechanism used to counter the viral infection. Experimental studies certainly indicate that, after an early peak of interferon production, there is a rapid fall in the titer of live virus in the lungs of mice infected with influenza (Figure 11.20). Antibody, as assessed by the serum titer, seems to arrive on the scene much too late to be of value in aiding recovery. However, antibody levels may be elevated in the local fluids bathing the infected surfaces (e.g., nasal mucosa and lung), despite low serum titers, and it is the production of **anti-viral antibody** (most prominently secretory IgA) by locally deployed immunologically primed cells that is of major importance for the **prevention of subsequent infection**. Unfortunately, in so far as the common cold is concerned, a subsequent infection is likely to involve an antigenically unrelated virus so that general immunity to colds is difficult to achieve.

Cell-mediated immunity gets to the intracellular virus

Antibodies are unable to access the cell cytosol. Therefore CMI is required for dealing with virus lurking inside infected host cells (Figure 11.21). The importance of CMI for recovery from viral infections is underlined by the inability of children with primary T-cell immunodeficiency to cope with such viruses, whereas patients with Ig deficiency but intact CMI are not troubled in this way.

NK cells can kill virally infected targets

Early recognition and killing of a virally infected cell before replication occurs is of obvious benefit to the host. The importance of the NK cell in this role as an agent of preformed innate immunity can be gauged from observations on the exceedingly

rare patients with complete absence of these cells who suffer recurrent life-threatening viral infections, including EBV, varicella, and cytomegaloviruses. The NK cell possesses two groups of surface receptors: **killer activatory receptors** bind to carbohydrate and other structures expressed collectively by all cells, and **killer inhibitory receptors** recognize MHC class I molecules and overrule the signal from the activating receptor. Thus, NK cells survey tissues for the absence of self as indicated by aberrant or absent expression of MHC class I, which occurs in certain viral infections and on some tumor cells. The production of IFN α during viral infection not only protects surrounding cells but also activates NK cells.

Cytotoxic T-cells mediate specific immunity to viruses

T-lymphocytes from a sensitized host are directly cytotoxic to cells infected with viruses, the new MHC-associated peptide antigens on the target cell surface being recognized by specific $\alpha\beta$ receptors on the cytotoxic T-lymphocytes. Downregulation of MHC class I poses no problems for those T-cells with a $\gamma\delta$ T-cell receptor as these recognize native viral coat protein (e.g., herpes simplex virus glycoprotein) on the cell surface (Figure 11.21). After a natural infection, both antibody and cytotoxic T-cells (CTLs) are generated; subsequent protection is long-lived without reinfection.

Cytokines recruit effectors and provide a cordon sanitaire

Studies on the transfer of protection to influenza, lymphocytic choriomeningitis, vaccinia, ectromelia, and CMV infections have indicated that CD8 rather than CD4 T-cells are the major defensive force. The knee-jerk response would be to implicate cytotoxicity, but remember that CD8 cells also produce cytokines. This may well be crucial when viruses escape the cytotoxic mechanism and manage to sidle laterally into an adjacent cell. CMI can now play some new cards: if T-cells stimulated by viral antigen release cytokines such as IFN γ and macrophage or monocyte chemokines, the mononuclear phagocytes attracted to the site will be activated to secrete TNF, which will synergize with the IFN γ to render the cells nonpermissive for the replication of any virus acquired by intercellular transfer (Figure 11.21). In this way, the site of infection can be surrounded by a cordon of resistant cells. Like IFN α , IFN γ increases the nonspecific cytotoxicity of NK cells for infected cells. This production of “immune interferon” (IFN γ) and TNF in response to non-nucleic acid viral components provides a valuable back-up mechanism when dealing with viruses that are intrinsically poor stimulators of type I interferon (IFN α and IFN β) synthesis.

Immunity to fungi

Opportunistic fungal infections often become established in immunocompromised hosts or when the normal commensal flora is upset by prolonged administration of broad-spectrum

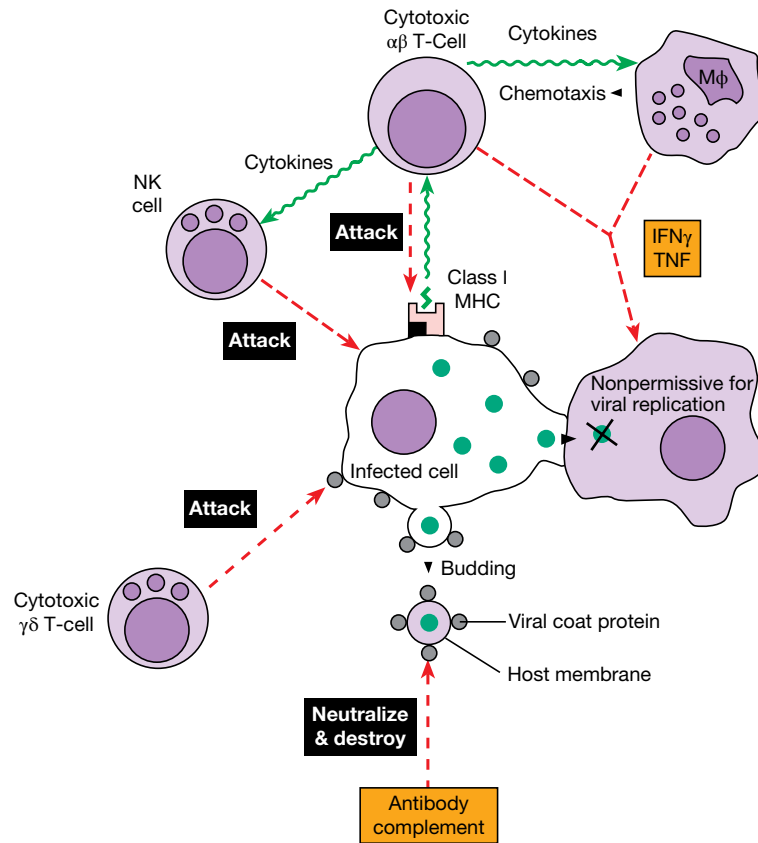


Figure 11.21 Control of infection by enveloped (“budding”) viruses. Free virus released by budding from the cell surface is neutralized by antibody. Specific cytotoxic T-cells kill virally infected targets directly and can release cytokines that attract macrophages ($M\phi$), prime contiguous cells to make them resistant to viral infection ($IFN\gamma$ and TNF), and activate cytotoxic NK cells. NK cells can recognize a lack of MHC class I on the infected cell membrane in the case of viruses that cause a downregulation of class I expression, or partake in antibody-dependent cellular cytotoxicity (ADCC) if antibody to viral coat proteins is bound to the infected cell. Included in this group of budding viruses are: oncorna (= oncogenic RNA virus, e.g., murine leukemogenic), orthomyxo (influenza), paramyxo (mumps, measles), toga (dengue), rhabdo (rabies), arena (lymphocytic choriomeningitis), adeno, herpes (simplex, varicella zoster, cytomegalo, Epstein–Barr, Marek’s disease), pox (vaccinia), papova (SV40, polyoma), and rubella viruses.

antibiotics. Phagocytosis, particularly following Th1-cell mediated activation of macrophages by $IFN\gamma$ and TNF , plays a major role in dealing with fungal infections. Thus, for example, decreased levels of $IFN\gamma$ are associated with an increased risk of systemic candidiasis. However, as already highlighted for certain bacteria, some fungi (e.g., *Histoplasma capsulatum*) are able to happily reside in macrophages. Reactive oxygen intermediates are fungicidal for most species by inducing protein modifications, damaging nucleic acid and causing lipid peroxidation. The fungal counterattack includes inhibition of the respiratory burst by catalase, mannitol, and melanin. Following inhalation of *Aspergillus fumigatus* the alveolar macrophages phagocytose and destroy conidia (spores), although fungal proteases may help protect the spores from such activities. In the lungs the conidia can germinate into branching hyphae, which are probably dealt with by the release of oxidants and fungicidal granule contents from neutrophils.

NK cells have been shown to have constitutive antifungal activity against, for example, *Cryptococcus neoformans*, whereas such activity against this organism needs to be induced in CTL. In the case of *A. fumigatus* the adaptive immune response becomes activated following uptake of conidia and hyphae by local dendritic cells and subsequent presentation to T-cells in the draining lymph nodes. Fungal cell wall components can signal dendritic cells through a number of pattern recognition receptors (Figure 11.22), resulting in the release of IL-12, which drives a Th1 response. Although Th17 responses can also be induced by fungi it seems that such responses can be either advantageous or disadvantageous for control of the pathogen. The outcome may well depend upon the context of the infection. The role of antibody is also complex and not always advantageous, although there are clear examples of protective effects, such as the antibodies to *Candida albicans* heat-shock protein 90 (hsp90) that are protective against disseminated disease in patients with AIDS.

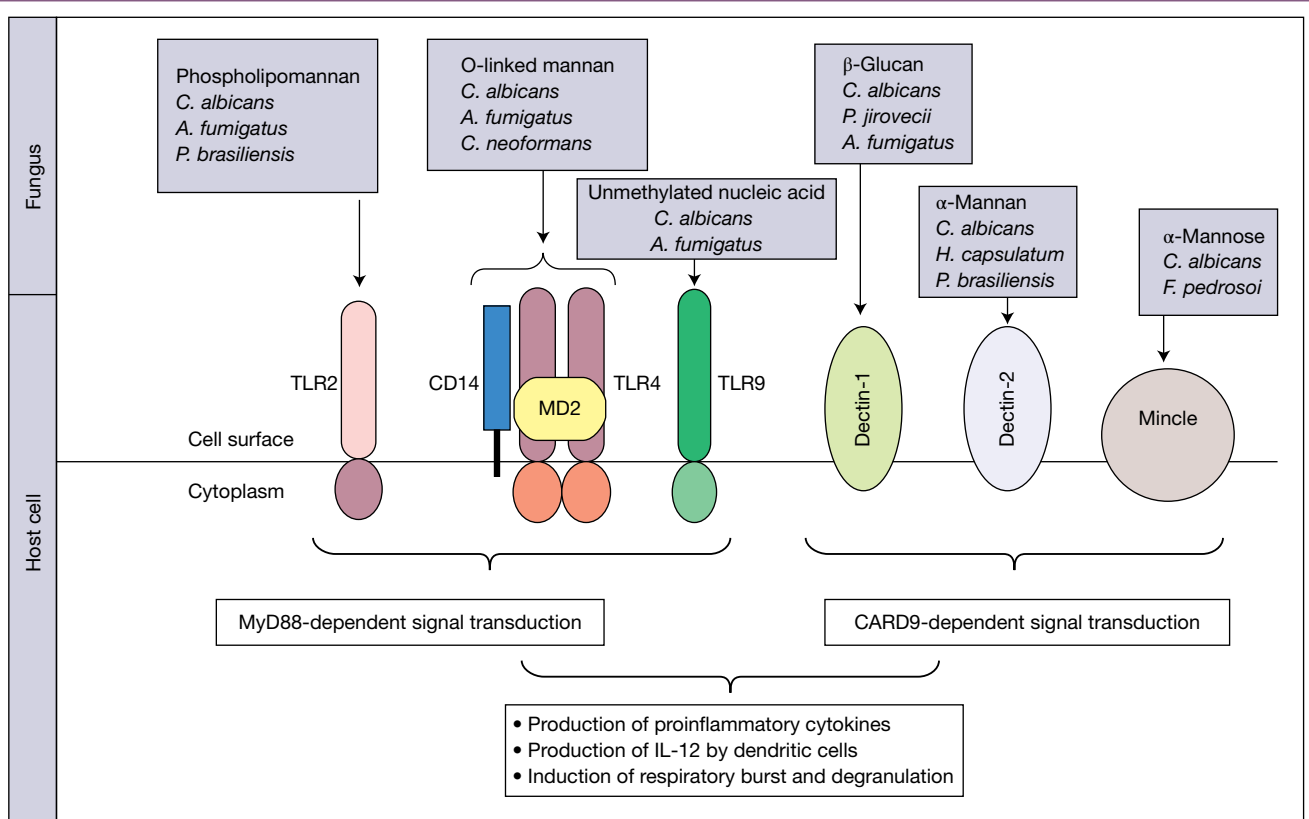


Figure 11.22 Pattern recognition receptor (PRR) mediated activation of immunity to fungi. A number of different pathogen-associated molecular patterns present on fungal cell walls can activate both the innate and adaptive immune response through the canonical MyD88 or CARD9 pathways following their recognition by PRRs on the host cells. CARD9, Caspase recruitment domain-containing protein 9; TLR, Toll-like receptor; *A. fumigatus*, *Aspergillus fumigatus*; *C. albicans*, *Candida albicans*; *C. neoformans*, *Cryptococcus neoformans*; *F. pedrosoi*, *Fonsecaea pedrosoi*; *H. capsulatum*, *Histoplasma capsulatum*; *P. brasiliensis*, *Paracoccidioides brasiliensis*; *P. jirovecii*, *Pneumocystis jirovecii*. (Adapted from Romani L. (2004) *Nature Reviews Immunology* 4, 1–23.)

Mannose-binding protein is able to agglutinate *Candida albicans* and subsequently activate the complement system.

The production of phospholipases, proteases, and elastases by many fungi function as virulence factors. Dimorphic fungi such as *Blastomyces dermatitidis*, *Coccidioides immitis*, and *Histoplasma capsulatum* transform from filamentous molds to unicellular yeasts, although some species of *Candida*, including *Candida albicans*, can take on the form of yeasts, blastospores, pseudohyphae, or hyphae depending on the site of the infection. The antigenic changes that accompany such morphological changes are presumed to act as virulence factors. Adhesins on the fungal surface also behave as virulence factors as their neutralization by antibody variable region fragments can block infection in an animal model of vaginal candidiasis.



Immunity to parasitic infections

The diverse organisms responsible for some of the major parasitic diseases are listed in Figure 11.23. The numbers affected are truly horrifying and the sum of misery these organisms

engender is too large to comprehend. The consequences of parasitic infection could be, at one extreme, a lack of immune response leading to overwhelming superinfection, and, at the other, an exaggerated life-threatening immunopathological response. Like all infectious agents, a successful parasite must steer a course between these extremes, avoiding wholesale killing of the human host and yet at the same time escaping destruction by the immune system.

The host responses

A wide variety of defensive mechanisms are deployed by the host, but the rough generalization may be made that a humoral response develops when the organisms invade the bloodstream (malaria, trypanosomiasis), whereas parasites that grow within the tissues (e.g., cutaneous leishmaniasis) usually elicit CMI (Figure 11.24). Often, a chronically infected host will be resistant to reinfection with fresh organisms, a situation termed **concomitant immunity**. This is seen particularly in schistosomiasis but also in malaria. The resident and the infective forms must differ in some way yet to be pinpointed.

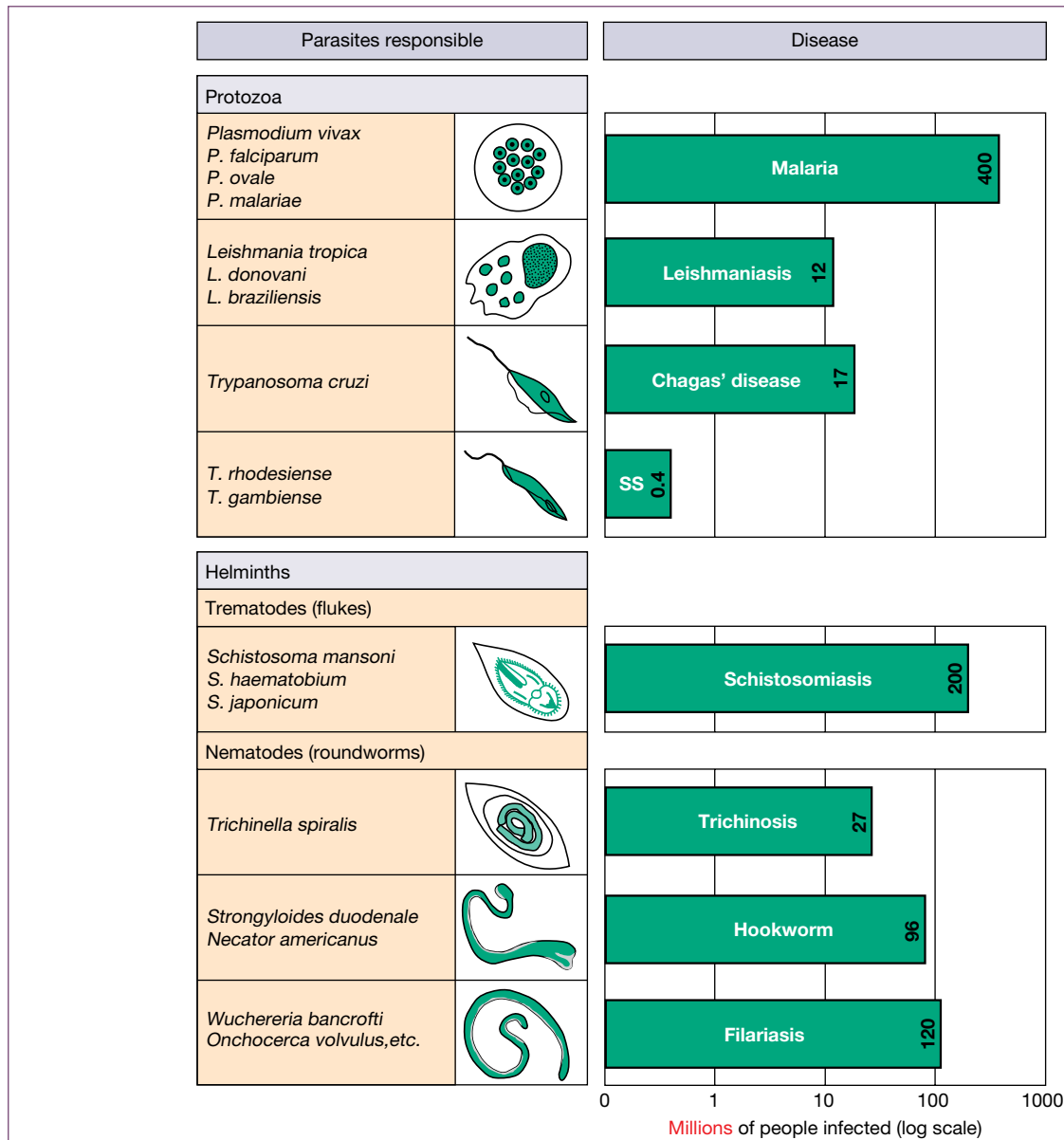


Figure 11.23 Some major parasites in humans and the sheer enormity of the numbers of people infected. SS, sleeping sickness. (Data source: World Health Organization, www.who.int.)

Humoral immunity

Antibodies of the right specificity present in adequate concentrations and affinity are reasonably effective in providing protection against blood-borne parasites, such as *Trypanosoma brucei*, and the sporozoite and merozoite stages of malaria. Thus, individuals receiving IgG from solidly immune adults in malaria endemic areas are themselves temporarily protected against infection, the effector mechanisms being opsonization for phagocytosis and complement-dependent lysis.

A marked feature of the immune reaction to helminthic infections, such as *Trichinella spiralis* in humans and *Nippostrongylus brasiliensis* in the rat, is the eosinophilia and

the high level of IgE antibody produced. In humans, serum levels of IgE can rise from normal values of around 100 ng/mL to as high as 10 000 ng/mL. These changes have all the hallmarks of response to Th2-type cytokines and it is notable that, in animals infected with helminths, injection of anti-IL-4 greatly reduces IgE production and anti-IL-5 suppresses the eosinophilia. IL-13 in the skin, which together with IL-4 is a switch factor for IgE production, seems to play an important role in protection against schistosomes. Antigen-specific triggering of IgE-sensitized mast cells leads to exudation of serum proteins containing high concentrations of protective antibodies in all the major Ig classes and the release of eosinophil

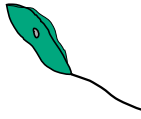
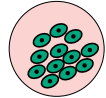
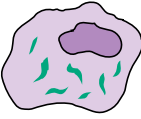
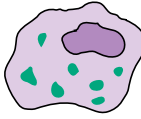
Parasite	<i>Trypanosoma brucei</i>	<i>Plasmodium</i>	<i>Trypanosoma cruzi</i>	<i>Leishmania</i>
Habitat	Free in blood 	Inside erythrocyte or hepatocyte 	Inside macrophage 	Inside macrophage 
Antibody				
Importance	++++	+++	++	+
Mechanism	Lysis with complement Opsonizes for phagocytosis	Blocks invasion Opsonizes for phagocytosis	Limits spread in acute infection	Limits spread
Means of evasion	Antigenic variation	Intracellular habitat Antigenic variation	Intracellular habitat	Intracellular habitat
Cell-mediated				
Importance	-	+	+++ (Chronic phase)	++++
Mechanism	-	Cytokine-mediated activation of macrophages for erythrocyte stage. CTL for liver stage	Macrophage activation by cytokines and killing by TNF, metabolites of O ₂ and NO. Role for cytotoxic T-cells	

Figure 11.24 The relative importance of antibody and cell-mediated responses in protozoal infections.

chemotactic factor. IgE can facilitate ADCC toward schistosomula, the early immature form of the schistosome, and this can be mediated by eosinophils, monocytes, macrophages, and platelets. Schistosomula can also be killed by eosinophils using IgG for ADCC via binding through their FcγRII receptors to the IgG-coated organism (Figure 11.25); the major basic protein of the eosinophilic granules is released onto the parasite and brings about its destruction. There may also be a localized requirement for Th1 cells given that IFNγ in the liver has been shown to be important in immunity to schistosomes. Two further points are in order. The IgE-mediated reactions may be vital for recovery from infection, whereas the resistance in vaccinated hosts may be more dependent upon preformed IgG and IgA antibodies.

Cell-mediated immunity

Just like certain bacteria and fungi, some parasites have adapted to life within the macrophage despite the possession by that cell of potent microbicidal mechanisms including NO₂. Intracellular organisms, such as *Toxoplasma gondii*, *Trypanosoma cruzi*, and *Leishmania* spp., use a variety of ploys to subvert the macrophage killing systems, but again, as with, for example, mycobacterial infections, cytokine-producing T-cells are crucially important for the stimulation of macrophages to release their killing power and dispose of the unwanted intruders.

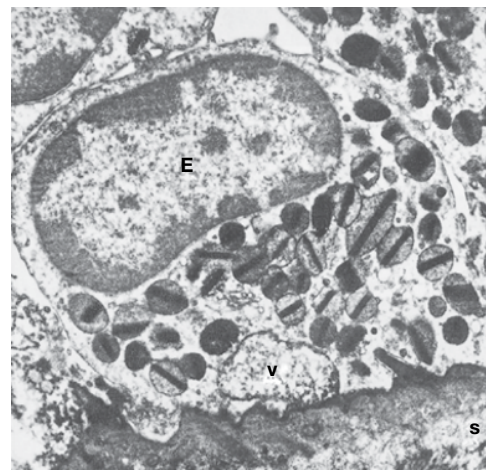


Figure 11.25 Electron micrograph showing an eosinophil (E) attached to the surface of a schistosomulum (S) in the presence of specific antibody. The cell develops large vacuoles (V) that appear to release their contents on to the parasite (×16 500). (Source: D.J. McLaren and C.D. Mackenzie. Reproduced with permission.)

The balance of cytokines produced is of the utmost importance. Infection of mice with *Leishmania major* is instructive in this respect; the organism produces fatal disease in susceptible mice but other strains are resistant. This is partly controlled by alleles of the *SLC11A1* gene but, as discussed earlier in

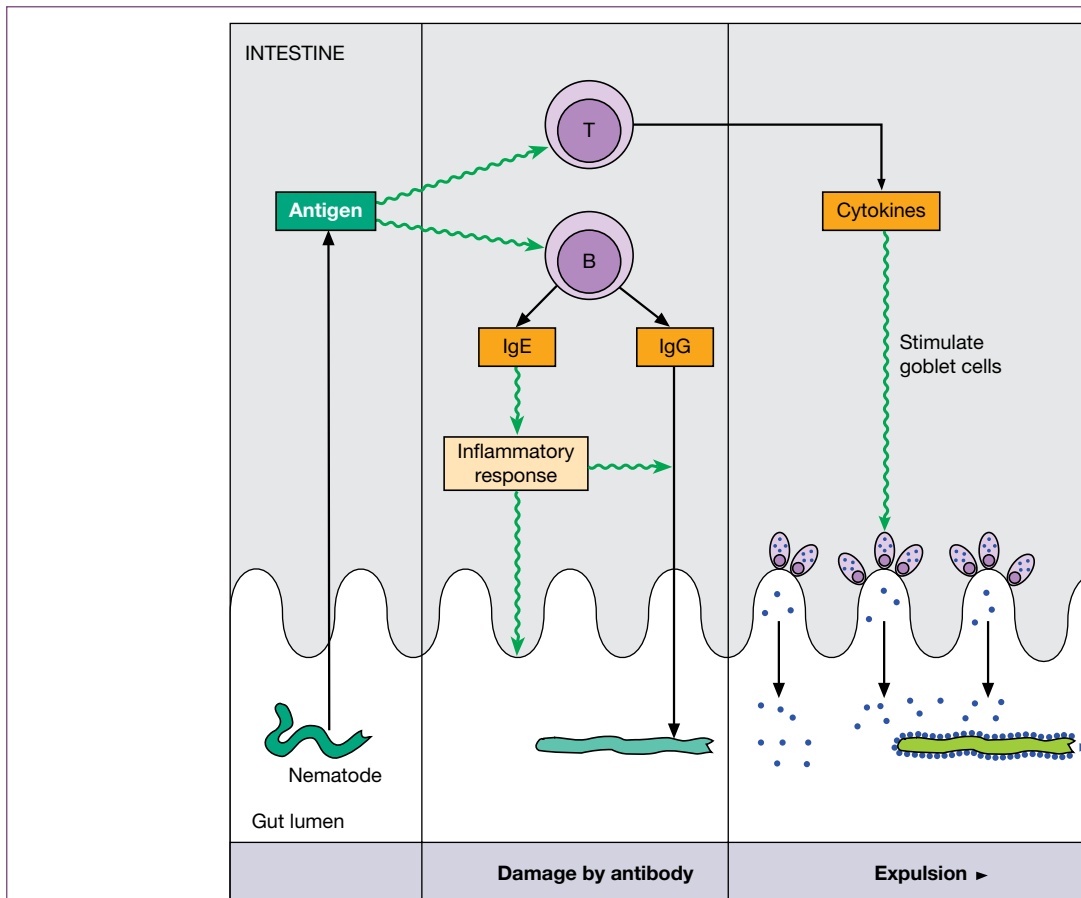


Figure 11.26 Expulsion of nematode worms from the gut. The parasite is first damaged by IgG antibody passing into the gut lumen, perhaps as a consequence of IgE-mediated inflammation and possibly aided by accessory ADCC cells. Cytokines such as IL-4, IL-13, and TNF released by antigen-specific triggering of T-cells stimulate proliferation of goblet cells and secretion of mucus, which coat the damaged worm and facilitate its expulsion from the body by increased gut motility induced by mast cell mediators, such as leukotriene- D_4 , and diarrhea resulting from inhibition of glucose-dependent sodium absorption by mast cell-derived histamine and PGE_2 .

Chapter 8, in susceptible mice there is excessive stimulation of Th2 cells producing IL-4 that do not help to eliminate the infection, whereas resistant strains are characterized by the expansion of Th1 cells that secrete $IFN\gamma$ in response to antigen presented by macrophages harboring living protozoa. Organisms such as malarial plasmodia (and, incidentally, the rickettsiae and chlamydiae bacteria) that live in cells that are not professional phagocytes may be eliminated through activation of intracellular defense mechanisms. Of particular importance for protection, however, is the induction of $IFN\gamma$ and $CD8^+$ T-cells. Interleukin-12 and nitric oxide are also required, and NK cells may play a subsidiary role by producing additional $IFN\gamma$. Direct cytotoxicity by $CD8^+$ T-cells has been observed against hepatic cells harboring malarial sporozoites. It is pertinent to note that, following the recognition of an association between HLA-B53 and protection against severe malaria, B53-restricted CTLs reacting with a conserved nonamer from a liver stage-specific antigen were demonstrated in the peripheral blood of resistant individuals. A large case-control study of

malaria in Gambian children showed that the protective B53 class I antigen is common in West African children but rare in other racial groups, lending further credence to the hypothesis that MHC polymorphism has evolved primarily through natural selection by infectious pathogens.

Eliminating worm infestations of the gut requires the combined forces of cellular and humoral immunity to expel the unwanted guest. One of the models studied is the response to *Nippostrongylus brasiliensis*; transfer studies in rats showed that, although antibody produces some damage to the worms, T-cells from immune donors are also required for vigorous expulsion, probably achieved through a combination of mast cell-mediated stimulation of intestinal motility and cytokine activation of the intestinal goblet cells. These secrete mucins that surround the worm, so protecting the colonic and intestinal surfaces from invasion (Figure 11.26). Another model, this time of *Trichinella spiralis* infection in mice, reinforces the importance of activating the most appropriate T-cell cytokine responses. One strain, which expels adult worms rapidly, makes

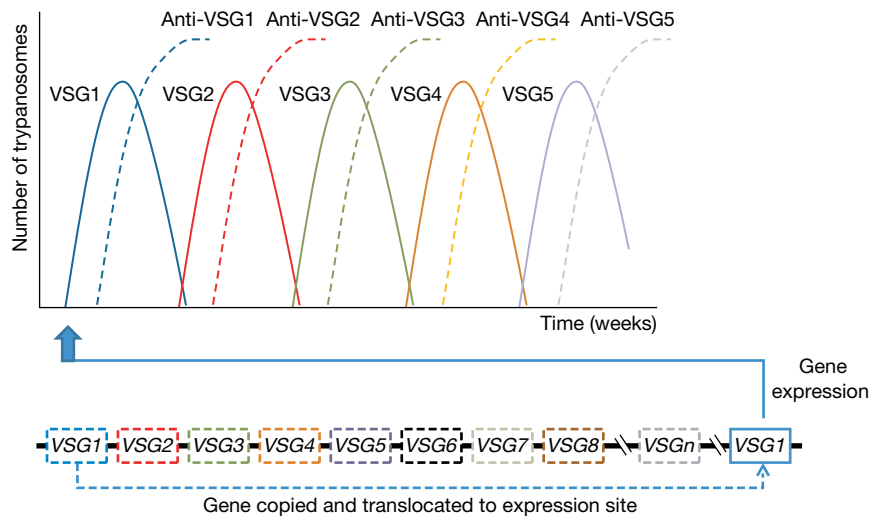


Figure 11.27 Antigenic variation during chronic trypanosome infection. As antibody to the initial variant surface glycoprotein VSG1 is formed, the blood trypanosomes become coated prior to phagocytosis and are no longer infective, leaving a small number of viable parasites that have acquired a new antigenic constitution. This new variant (VSG2) now multiplies until, too, is neutralized by the primary antibody response and is succeeded by variant VSG3. At any time, only one of the variant surface glycoproteins is expressed and covers the surface of the protozoan to the exclusion of all other antigens. Nearly 9% of the trypanosome genome (approximately 1000 genes) is devoted to generation of VSGs. Switching occurs by insertion of a duplicate gene into a new genomic location in proximity to the promoter.

large amounts of $\text{IFN}\gamma$ and IgG2a antibody, whereas, in contrast, more susceptible mice make miserly amounts of $\text{IFN}\gamma$ and favor IgG1, IgA, and IgE antibody classes. Clearly, the protective strategy varies with the infection.

Evasive strategies by the parasite

Resistance to effector mechanisms

Some tricks to pre-empt the complement defenses are of interest. *T. cruzi* has elegantly created a DAF-like molecule that accelerates the decay of C3b. The *Schistosoma mansoni* SCIP1 molecule (schistosome C inhibitory protein 1) is a surface-exposed form of the muscle protein paramyosin, which is able to bind C9, thereby inhibiting its polymerization and preventing formation of the membrane attack complex. The *Plasmodium falciparum* erythrocyte membrane protein 1 (PfEMP1) is expressed on the surface of infected erythrocytes and can bind to CR1 (CD35) on other infected erythrocytes, leading to clustering of the red cells, which may facilitate spread of the parasite with minimal exposure to the host immune system. In a similar fashion, malarial sporozoites shed their circumsporozoite antigen when it binds antibody, and *Trypanosoma brucei* releases its surface antigens into solution to act as decoy proteins. In each case, these shedding and decoy systems are well suited to parasites or stages in the parasite life cycle that are only briefly in contact with the immune system.

Protozoal parasites that hide away from the effects of antibody by using the interior of a macrophage as a sanctuary block microbicidal mechanisms using similar methods to those

deployed by intracellular bacteria. *Toxoplasma gondii* inhibits phagosome–lysosome fusion by lining up host cell mitochondria along the phagosome membrane. *Trypanosoma cruzi* escapes from the confines of the phagosome into the cytoplasm, while leishmania parasites are surrounded by a lipophosphoglycan that protects them from the oxidative burst by scavenging oxygen radicals. They also downregulate expression of MHC, CD80, and CD86, so diminishing T-cell stimulation.

Avoiding antigen recognition by the host

Some parasites *disguise* themselves to look like the host. This can be achieved by molecular mimicry as demonstrated by cross-reactivity between ascaris antigens and human collagen. Another way is to cover the surface with host protein. Schistosomes are very good at that; the adult worm takes up host red-cell glycoproteins, MHC molecules, and IgG and lives happily in the mesenteric vessels of the host, despite the fact that the blood that bathes it contains antibodies that can prevent reinfection.

Another very crafty ruse, rather akin to moving the goalposts in football, is **antigenic variation**, in which the parasites escape from the cytotoxic action of antibody on their cycling blood forms by the ingenious trick of altering their antigenic constitution. Figure 11.27 illustrates how the trypanosome continues to infect the host, even after fully protective antibodies appear, by switching to the expression of a new antigenic variant that these antibodies cannot recognize; as antibodies to the new antigens are synthesized, the parasite escapes again by changing to yet a further variant and so on. In this way, the

parasite can remain in the bloodstream long enough to allow an opportunity for transmission by blood-sucking insects or blood-to-blood contact. The same phenomenon has been observed with *Plasmodium* spp. and this may explain why, in hyperendemic areas, children are subjected to repeated attacks of malaria for their first few years and are then solidly immune to further infection. Immunity must presumably be developed against all the antigenic variants before full protection can be attained, and indeed it is known that IgG from individuals with solid immunity can effectively terminate malaria infections in young children.

Deviation of the host immune response

Immunosuppression has been found in most of the parasite infections studied. During infection by trypanosomes, for example, there is polyclonal activation of both T- and B-cell responses that diverts the immune response away from specific antibody production. A secreted proline racemase (an enzyme that catalyzes the interconversion of L- and D-forms of proline) from *T. cruzi* has been identified as a B-cell mitogen. Parasites may also manipulate T-cell subsets to their own advantage. Filariasis provides a case in point: the cytokines that are induced by filarial infection, which include TGF β and IL-10, favor regulatory T-cell mediated responses.

Epidemiological surveys accord with a protective role for IgE antibodies in schistosomiasis, but they also reveal a susceptible human subpopulation producing IgM and IgG4 antibodies that can block IgE-mediated ADCC. The ability of certain helminths to polyclonally activate IgE-producing B-cells is good for the parasite and correspondingly not so good for the host, as a high concentration of irrelevant IgE binding to a mast cell will crowd out the parasite-specific IgE molecules and diminish the possibility of triggering the mast cell by specific antigen to initiate a protective defensive reaction.

Immunopathology

Where parasites persist chronically in the face of an immune response, the interaction with foreign antigen frequently produces tissue-damaging reactions. One example is the immune complex-induced nephrotic syndrome of Nigerian children associated with the quartan malaria that is caused by *Plasmodium malariae* and characteristically has a 72 hour chill and fever pattern related to the life cycle of the parasite. Increased levels of TNF are responsible for pulmonary changes in acute malaria, cerebral malaria in mice, and severe wasting of cattle with trypanosomiasis. Another example is the liver damage resulting from IL-4-mediated granuloma formation around schistosome eggs (see Figure 14.29); one of the egg antigens directly induces IL-10 production in B-cells, thereby contributing to Th2 dominance. Remarkably, the hypersensitivity reaction helps the eggs to escape from the intestinal blood capillaries into the gut lumen to continue the cycle outside the body, an effect mediated by TNF.

Cross-reaction between parasite and self may give rise to autoimmunity, and this has been proposed as the basis for the cardiomyopathy in Chagas' disease. It is also pertinent that the nonspecific immunosuppression that is so widespread in parasitic diseases tends to increase susceptibility to bacterial and viral infections and, in this context, the association between Burkitt's lymphoma and malaria has been ascribed to an inadequate host response to the Epstein-Barr virus.

Prions

Variante Creutzfeldt-Jakob disease (vCJD) was first described in 1996 and, in common with sheep scrapie and bovine spongiform encephalopathy (BSE), is classed as a transmissible spongiform encephalopathy (TSE) caused by prions. The BSE prion, responsible for "mad cow disease," became adapted to humans after consumption of meat from cattle that had been fed with the remains of previously slaughtered livestock. This disease has caused much alarm, particularly at the epicenter of the infection in Great Britain, because of the unpredictable nature of the "epidemic." However, by the end of 2015 the number of deaths in the UK from vCJD stood at 178 and it may be that the huge number of fatalities that some mathematical models originally predicted will not actually occur.

In the TSE diseases the normal nonpathogenic cellular prion protein (PrP^c), of unknown function, becomes abnormally folded causing the generation of relatively protease-resistant pathogenic aggregates referred to as PrP^{sc} (the "scrapie" protein). Unfortunately, the role of the immune system in prion diseases seems to be one of helping the disease rather than combating it. Infectivity usually replicates to high levels in lymphoid tissues before spreading to the central nervous system, with follicular dendritic cells (FDCs) in spleen, lymph node, and Peyer's patches involved in this replication. FDCs naturally express high levels of PrP^c that then converts to PrP^{sc} following exposure to the TSE agent. B-lymphocytes play a subsidiary role via their production of TNF and lymphotoxin, both cytokines being necessary for the formation of FDC networks in the secondary lymphoid tissues, the lymphotoxin being further required for the maintenance of the differentiated state in the FDCs. In addition to FDCs, macrophages and dendritic cells appear to be involved in the replication of PrP^{sc}, thereby providing a reservoir of infectivity. It is not currently clear if innate responses are induced to PrP^{sc} but adaptive immune responses do not seem to occur, possibly because of the immunological tolerance that has been established against the naturally occurring PrP^c. The infective prions pass from the FDC to peripheral nerves in the secondary lymphoid tissues and then move to the CNS.

Once they enter the CNS the infectious prions cause activation of astrocytes and microglia, the latter being the macrophages of the brain. It is possible that infection of microglia with PrP^{sc} converts them from a phagocytic phenotype into a deleterious proinflammatory phenotype. It is hoped that ongoing research will further clarify the contribution of the immune system to prion diseases.

- Immunity to infection involves a constant battle between the host defenses and the pathogen trying to evolve evasive strategies.

Inflammation revisited

- Inflammation is a major defensive reaction initiated by infection or tissue injury.
- The mediators released upregulate adhesion molecules on endothelial cells and leukocytes causing, first, rolling of leukocytes along the vessel wall and then passage across the blood vessel up the chemotactic gradient to the site of inflammation.
- IL-1 β , TNF, and chemokines such as IL-8 are involved in maintaining the inflammatory process.
- Inflammation is controlled by complement regulatory proteins, PGE₂, TGF β , glucocorticoids, and IL-10.
- Inability to eliminate the initiating agent leads to a chronic inflammatory response dominated by macrophages, often forming granulomas.

Extracellular bacteria susceptible to killing by phagocytosis and complement

- LPS is bound by LBP, which transfers the LPS to the CD14–TLR4 complex, thereby activating genes in the APC which encode proinflammatory cytokines.
- Bacteria try to avoid phagocytosis by surrounding themselves with capsules, secreting exotoxins that kill phagocytes or impede inflammatory reactions, deviating complement to inoffensive sites or by colonizing relatively inaccessible locations.
- Antibody combats these tricks by neutralizing the toxins, facilitating complement-mediated lesions on the bacterial surface, and overcoming the antiphagocytic nature of the capsules by opsonizing them with Ig and C3b.
- The secretory immune system protects the external mucosal surfaces. Secretory IgA inhibits adherence of bacteria and can opsonize them. IgE bound to mast cells can initiate the influx of protective IgG, complement, and neutrophils.

Bacteria that grow in an intracellular habitat

- Intracellular bacteria such as tubercle and leprosy bacilli grow within macrophages. They defy killing mechanisms by blocking macrophage activation, neutralizing the pH in the phagosome, inhibiting lysosome fusion, and by escaping from the phagosome into the cytoplasm.
- They are killed by CMI: T-helpers release cytokines on contact with infected macrophages that powerfully activate the formation of nitric oxide (NO \cdot), reactive oxygen intermediates (ROIs), and other microbicidal mechanisms.

Immunity to viral infection

- Viruses try to avoid the immune system by changes in the antigenicity of their surface antigens. Point mutations bring about antigenic drift, but radical changes leading to epidemics can result from wholesale swapping of genetic material with different viruses in other animal hosts (antigenic shift).

- Some viruses subvert the function of the complement system to their own advantage.
- Viruses can interfere with almost every step in the processing and presentation of antigen to T-cells.
- Antibody neutralizes free virus and is particularly effective when the virus has to travel through the bloodstream before reaching its final target.
- Where the target is the same as the portal of entry (e.g., the lungs) IFN is dominant in recovery from infection.
- Antibody is important in preventing reinfection.
- “Budding” viruses that can invade adjacent cells without becoming exposed to antibody are combated by CMI. Infected cells express a processed viral antigen peptide on their surface in association with MHC class I a short time after entry of the virus, and rapid killing of the cell by cytotoxic $\alpha\beta$ T-cells prevents viral multiplication that depends upon the replicative machinery of the intact host cell. $\gamma\delta$ Tc cells recognize native viral coat protein on the target cell surface. NK cells are also cytotoxic.
- T-cells and macrophages producing IFN γ and TNF bathe the adjacent cells and prevent them from becoming infected by lateral spread of virus.

Immunity to fungi

- Opportunistic fungal infections are common in immunosuppressed hosts.
- Fungal cell wall components are detected by host pattern recognition receptors which signal through canonical MyD88 or CARD9 pathways.
- Phagocytosis plays a major role in dealing with fungi.
- CTL and NK cells exhibit antifungal activities.
- Antibody is not always advantageous, but does appear to help protect against systemic candida infections in patients with AIDS.

Immunity to parasitic infections

- Diseases involving protozoal parasites and helminths affect hundreds of millions of people. Antibodies are usually effective against the blood-borne forms. IgE production is increased in worm infestations and can lead to mast cell-mediated influx of Ig and eosinophils; schistosomes coated with IgG or IgE are killed by adherent eosinophils through extracellular mechanisms involving the release of cationic proteins and peroxidase.
- Organisms such as *Leishmania* spp., *Trypanosoma cruzi*, and *Toxoplasma gondii* hide from antibodies inside macrophages, use the same strategies as intracellular parasitic bacteria to survive, and like them are killed when the macrophages are activated by Th1 cytokines produced during cell-mediated immune responses. NO \cdot is an important killing agent.
- CD8 T-cells also have a protective role.
- Expulsion of intestinal worms usually depends on Th2 responses and requires the coordinated action of antibody, the release of mucin by cytokine-stimulated goblet cells and the production of intestinal contraction and diarrhea by mast cell mediators.

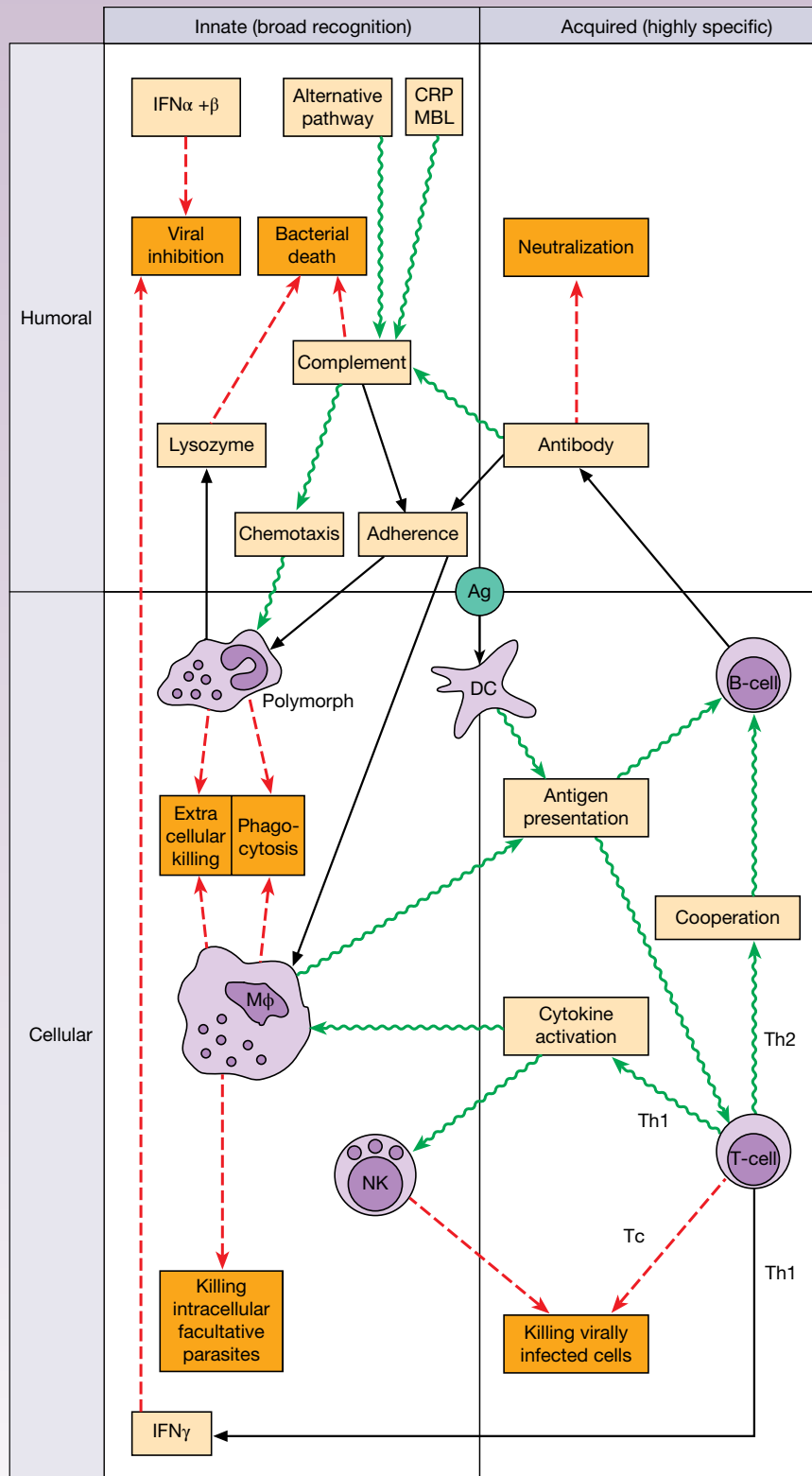


Figure 11.28 Simplified scheme to emphasize the interactions between innate and acquired immunity. The dendritic cell that presents antigen to B-cells in the form of immune complexes is the follicular dendritic cell in germinal centers, whereas the MHC class II-positive interdigitating dendritic cell presents antigen to T-cells. CRP, C-reactive protein; MBL, mannose-binding lectin. (Adapted from Playfair J.H.L. (1974) *British Medical Bulletin* 30, 24.)

- Some parasites avoid recognition by disguising themselves as the host, either through molecular mimicry or by absorbing host proteins to their surface.
- Other organisms such as *Trypanosoma brucei* and various malarial species have the extraordinary ability to express on their surface a dominant antigen that is changed by genetic switch mechanisms to a different molecule as antibody is formed to the first variant.
- Most parasites also tend to nonspecifically suppress host responses.
- Chronic persistence of parasite antigen in the face of an immune response often produces tissue-damaging immunopathological reactions such as immune complex nephrotic syndrome, liver granulomas, and autoimmune

lesions of the heart. Generalized immunosuppression increases susceptibility to bacterial and viral infections.

- As the features of the response to bacterial, viral, fungal, and parasitic infection are analyzed, we see more clearly how the specific acquired response operates to amplify and enhance innate immune mechanisms; the interactions are summarized in Figure 11.28.

Prion diseases

- Scrapie, BSE, and vCJD are transmissible spongiform encephalopathies caused by prions.
- Abnormally folded, protease-resistant forms of host prion protein (PrP) develop.
- FDCs in lymphoid tissues become infected prior to spread of the infectious agent to the CNS.



Now visit www.roitt.com to test yourself on this chapter.

FURTHER READING

- Aguzzi A., Nuvolone M., and Zhu C. (2013) The immunobiology of prion diseases. *Nature Reviews Immunology* **13**, 888–902.
- Alcami A., Hill A.B., and Koszinowski U.H. (2007) Viral interference with the host immune response. In *Topley & Wilson's Microbiology & Microbial Infections*, 10th edn. Wiley-Blackwell, Oxford, pp. 617–644.
- Barth K., Remick D.G., and Genco C.A. (2013) Disruption of immune regulation by microbial pathogens and resulting chronic inflammation. *Journal of Cellular Physiology* **228**, 1413–1422.
- Baxt L.A., Garza-Mayers A.C., and Goldberg M.B. (2013) Bacterial subversion of host innate immune pathways. *Science* **340**, 697–701.
- Centers for Disease Control and Prevention. The following websites of the Centers for Disease Control and Prevention contain a large body of information: <http://www.cdc.gov/DiseasesConditions/>, parasitic diseases: <http://www.cdc.gov/parasites/>
- Epperson M.L., Lee C.A., and Fremont DH. (2012) Subversion of cytokine networks by virally encoded decoy receptors. *Immunology Reviews* **250**, 199–215.
- Goering R., Dockrell H., Zuckerman M., Roitt I., and Chiodini P. (2012) *Mim's Medical Microbiology*, 5th edn. Saunders, London.
- Goubau D., Deddouch S., and Reis e Sousa C. (2013) Cytosolic sensing of viruses. *Immunity* **38**, 855–869.
- Lewis D.B. (2006) Avian flu to human influenza. *Annual Review of Medicine* **57**, 139–154.
- Liu L., Johnson H.L., Cousens S., *et al.* (2012) Global, regional, and national causes of child mortality: an updated systematic analysis for 2010 with time trends since 2000. *Lancet* **379**, 2151–2161.
- Lozano R., Naghavi M., Foreman K., *et al.* (2012) Global and regional mortality from 235 causes of death for 20 age groups in 1990 and 2010: a systematic analysis for the Global Burden of Disease Study 2010. *Lancet* **380**, 2095–2128.
- Netea M.G., Joosten L.A., van der Meer J.W., Kullberg B.J., and van de Veerdonk F.L. (2015) Immune defence against *Candida* fungal infections. *Nature Reviews Immunology* **15**, 630–642.
- O'Garra A., Redford P.S., McNab F.W., Bloom C.I., Wilkinson R.J., and Berry M.P. (2013) The immune response in tuberculosis. *Annual Review of Immunology* **31**, 475–527.
- Papayannopoulos V. and Zychlinsky A. (2009) NETs: a new strategy for using old weapons. *Trends in Immunology* **30**, 513–521.
- Pradeu T. and Cooper E.L. (2012) The danger theory: 20 years later. *Frontiers in Immunology* **287**, 1–9.
- Schuren A.B., Costa A.I., and Wiertz E.J. (2016) Recent advances in viral evasion of the MHC Class I processing pathway. *Current Opinion in Immunology* **40**, 43–50.
- Underhill D.M. and Pearlman E. (2015) Immune Interactions with Pathogenic and Commensal Fungi: A Two-Way Street. *Immunity* **43**, 845–858.
- von Moltke J., Ayres J.S., Kofoed E.M., Chavarría-Smith J., and Vance R.E. (2013) Recognition of bacteria by inflammasomes. *Annual Review of Immunology* **31**, 73–106.
- Zipfel P.F., Hallström T., and Riesbeck K. (2013) Human complement control and complement evasion by pathogenic microbes – tipping the balance. *Molecular Immunology* **56**, 152–160.

CHAPTER 12

Vaccines

Key topics

- Passively acquired immunity 354
- Principles of vaccination 357
- Killed organisms as vaccines 357
- Live attenuated organisms have many advantages as vaccines 358
- Subunit vaccines 362
- Newer approaches to vaccine development 365
- Current vaccines 368
- Vaccines under development 368
- Vaccines against parasitic diseases have proved particularly difficult to develop: malaria 368
- Vaccines for protection against bioterrorism 372
- Immunization against cancer 373
- Other applications for vaccines 373
- Adjuvants 373

Just to recap ...

The mechanisms by which we resist the onslaught of microbes have been discussed. These mechanisms include humoral, cellular, and innate immunity. One of the great triumphs of medicine has been the ability to harness these mechanisms through vaccination to protect against a host of infectious diseases.

Introduction

The control of infection is approached from several directions. Improvements in public health – water supply, sewage systems, education in personal hygiene – prevent the spread of cholera and many other diseases. Antibiotics have had a major impact on bacterial diseases. Another strategy is to give the immune response a helping hand. This can be achieved by administering individual components of the immune response, such as

antibodies, by using immunopotentiating agents such as cytokines, or more commonly by exposing the immune system to an antigen in order to stimulate the acquired immune response to generate memory – a procedure referred to as vaccination (see Milestone 12.1). Vaccines have traditionally been aimed at generating responses against infectious agents, but increasingly they are also being explored in areas such as malignancy.

Passively acquired immunity

Passively administered antibody

Temporary protection against infection and clearance of toxins can be achieved by giving antibody isolated from the plasma of an individual having a high antibody titer to the pathogen or a hyperimmunized animal (Table 12.1 and Figure 12.1). Prior



Milestone 12.1 Vaccination

The notion that survivors of serious infectious disease seldom contract that infection again has been embedded in folklore for centuries. In an account of the terrible plague that afflicted Athens, Thucydides noted that, in the main, those nursing the sick were individuals who had already been infected and yet recovered from the plague. Deliberate attempts to ward off infections by inducing a minor form of the disease in otherwise healthy subjects were common in China in the Middle Ages. There, they developed the practice of inhaling a powder made from **smallpox** scabs as protection against any future infection. In India, healers inoculated scab material into small skin wounds; this practice of **variolation** (from the Latin *varus*, a pustular facial disease) was introduced into Turkey where the inhabitants were determined to prevent the ravages of smallpox epidemics interfering with the lucrative sale of their gorgeous daughters to the harems of the wealthy.

The writer Voltaire, in 1773, tells us that the credit for spreading the practice of variolation to western Europe should be attributed to Lady Wortley Montague, a remarkably enterprising woman who was the wife of the English Ambassador to Constantinople in the time of George I. With little scruple, she inoculated her daughter with smallpox in the face of the protestations of her chaplain, who felt that it could only succeed with infidels, not Christians. All went well, however, and the practice was taken up in England despite the hazardous nature of the procedure with a case fatality of 0.5–2%. These dreadful risks were taken because, at that time, as Voltaire recorded, “three score persons in every hundred have the smallpox. Of these three score, twenty die of it in the most favorable season of life, and as many more wear the disagreeable remains of it on their faces so long as they live.”

Edward Jenner (1749–1823) (Figure M12.1.1), a country physician in Gloucestershire, England, suggested to one of his patients that she might have smallpox, but she assured him that his diagnosis was impossible as she had already contracted cowpox through her chores as a milkmaid (folklore again!). This led Jenner to the series of experiments in which he showed that prior inoculation with cowpox, which was nonvirulent (i.e., nonpathogenic) in the human, protected against subsequent challenge with smallpox. His ideas initially met with violent opposition but were eventually accepted and he achieved world fame; learned societies everywhere elected him to membership, although it is intriguing to note that the College of Physicians in London required him to pass an examination in classics and the Royal Society honored him with a Fellowship on the basis of his work on the nesting behavior of the cuckoo. In the end he inoculated thousands of people in the shed in the garden of his house in Berkeley, Gloucestershire, which now functions as a museum and venue for small symposia (rather fun to visit if you get the chance).

The next seminal development in vaccines came through the research of Louis Pasteur who had developed the germ theory of disease. A culture of chicken cholera bacillus, which had accidentally been left on a bench during the warm summer months, lost much of its ability to cause disease; nonetheless, birds that had been inoculated with this old culture were resistant to fresh virulent cultures of the bacillus. This **attenuation of virulent** organisms was reproduced by Pasteur for anthrax and rabies using abnormal culture and passage conditions. Recognizing the relevance of Jenner’s research for his own experiments, Pasteur called his treatment **vaccination**, a term that has stood the test of time.



Figure M12.1.1 Edward Jenner among patients in the Smallpox and Inoculation Hospital at St Pancras, London. Etching after J. Gillray, 1802. (Source: Wellcome Centre Medical Photographic Library, London.)

Table 12.1 Examples of passive antibody therapy against infection and toxins.

Condition	Source of antibody	Use
Tetanus infection	Human polyclonal	Antitoxin. Management of tetanus-prone wounds in patients where immunization is incomplete or uncertain
Botulism	Horse polyclonal	Antitoxin. Post-exposure prophylaxis of botulism
Snake bites (various)	Horse polyclonal	Antivenom. Treatment following venomous snake bite
Spider bites (various)	Horse polyclonal, rabbit polyclonal	Antivenom. Treatment following venomous spider bite
Paralysis tick bite	Dog polyclonal	Antivenom. Treatment following bite from paralysis tick
Stonefish sting	Horse polyclonal	Antivenom. Treatment following stonefish sting
Jellyfish sting	Sheep polyclonal	Antivenom. Treatment following venomous jellyfish sting
Hepatitis B infection	Human polyclonal	Antiviral. Prevention of infection in laboratory and other personnel accidentally inoculated with hepatitis B virus, and in infants of mothers infected during pregnancy or who are high-risk carriers
Rabies infection	Human polyclonal/monoclonal	Antiviral. Following bite from a possibly infected animal
Varicella-zoster virus infection	Human polyclonal	Antiviral. Seronegative individuals at increased risk of severe varicella (chickenpox)
Cytomegalovirus infection	Human polyclonal	Antiviral. Prophylaxis in immunosuppressed patients
Respiratory syncytial virus infection	Humanized mouse IgG1 monoclonal	Antiviral. Prevention of serious lower respiratory tract disease in high-risk children and infants

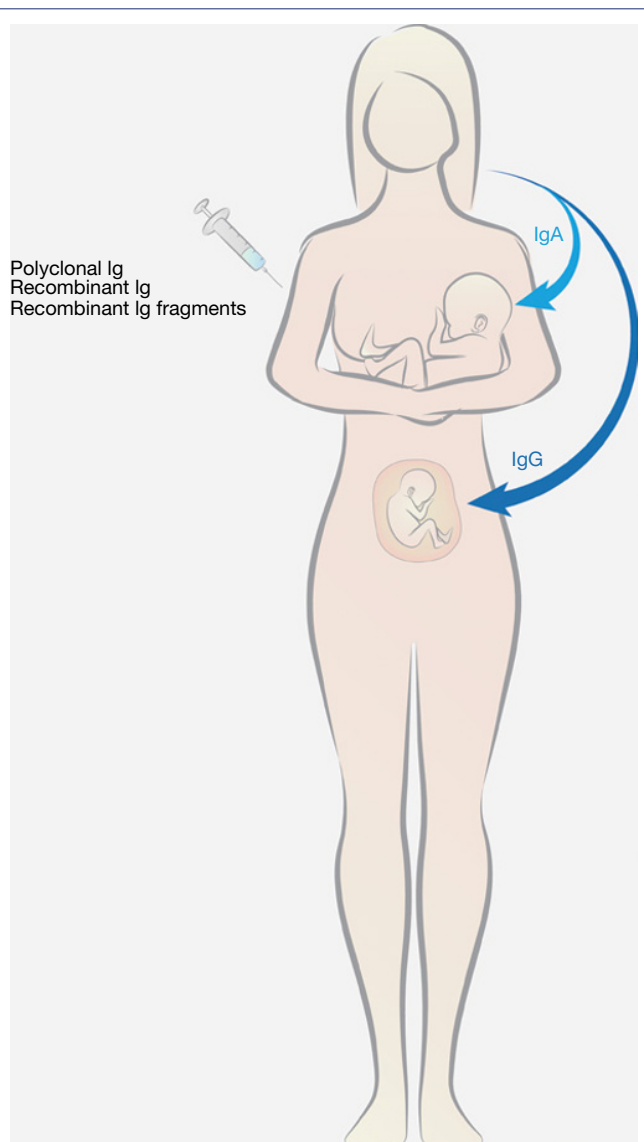


Figure 12.1 Passive immunization produced by: transplacental passage of IgG from mother to fetus, acquisition of IgA from mother's colostrum and milk by the infant, and injection of polyclonal antibodies, recombinant monoclonal antibodies, or antibody fragments (Fab or scFv).

to the introduction of antibiotics, horse serum containing anti-tetanus or anti-diphtheria toxins was extensively employed prophylactically, but nowadays it is used less commonly because of the complication of serum sickness (a type III hypersensitivity) and immediate (type I) hypersensitivity developing in response to the foreign protein. Furthermore, as the acquired antibodies are utilized by combination with antigen or are catabolized in the normal way, this protection is lost. The use of passive immunization is currently largely restricted to anti-venoms, in which an immediate therapeutic effect is required for a usually rare event such as a snake bite, and in prophylaxis for certain viral infections including

cytomegalovirus (CMV) and rabies. However, with the emergence of antibiotic-resistant strains of bacteria, and concerns about possible bioterrorism, there is a renewed interest in passive immunization against infectious agents. Increasingly, it is likely that polyclonal antibody preparations will be replaced by human monoclonal antibodies or combinations of such antibodies. For instance, a humanized mouse monoclonal antibody (Synagis®, MedImmune) is in use to prevent disease due to respiratory syncytial virus (RSV) in babies and young infants. A cocktail of two human monoclonal antibodies against rabies virus has been developed for use as a post-exposure prophylactic following a bite or a scratch from a rabid animal such as a dog or a bat and is in clinical trials. In this case, there is a window of opportunity for intervention as the rabies virus needs to gain access to the CNS to cause disease and circulating antibody can prevent this. Passive antibody in rabies treatment is augmented with vaccination.

Maternally acquired antibody

In the first few months of life, while the baby's own lymphoid system is slowly getting under way, protection is afforded to the fetus by maternally derived IgG antibodies acquired by placental transfer and to the neonate by intestinal absorption of colostrum immunoglobulins (Figure 12.1). The major immunoglobulin in milk is secretory IgA (SIgA) and this is not absorbed by the baby but remains in the intestine to protect the mucosal surfaces. In this respect it is quite striking that the SIgA antibodies are directed against bacterial and viral antigens often present in the intestine, and it is presumed that IgA-producing cells, responding to gut antigens, migrate and colonize breast tissue (as part of the mucosal immune system), where the antibodies they produce appear in the milk. The case for mucosal vaccination of future mothers against selected infections is strong. It should also be noted that it has been argued that one of the most important functions of antibody is in the maternally acquired role. The hypothesis is that maternal antibody attenuates many infections, allowing cellular immunity to mature under controlled conditions.

Intravenous immunoglobulin

Intravenous immunoglobulin (IVIg) is a preparation of IgG obtained by large-scale fractionation of plasma pooled from thousands of healthy blood donors. The preparations are given to individuals with immunodeficiencies associated with reduced or absent circulating antibody. IVIg is also of value in the treatment of a number of infection-associated conditions such as streptococcal toxic shock syndrome. IVIg also has efficacy in the treatment of several autoimmune and inflammatory diseases such as idiopathic thrombocytopenic purpura, chronic inflammatory demyelinating polyneuropathy, and Guillain-Barré syndrome. The mechanism of action in these non-immunodeficient patients remains unclear, although recent evidence suggests IVIg probably modulates immune activity through sialic acids on the Ig molecule.

Adoptive transfer of cytotoxic T-cells

This is a labor-intensive operation and will be restricted to autologous cells or instances in which the donor shares an MHC class I allele. Adoptive transfer of autologous cytotoxic T-lymphocytes has been shown to be effective in enhancing EBV-specific immune responses and in reducing the viral load in patients with post-transplant lymphoproliferative disease.



Principles of vaccination

Herd immunity

In the case of tetanus, active immunization is of benefit to the individual but not to the community as it will not eliminate the organism that is found in the feces of domestic animals and persists in the soil as highly resistant spores. Where a disease depends on human transmission, immunity in just a proportion of the population can help the whole community if it leads to a fall in the reproduction rate (i.e., the number of further cases produced by each infected individual) to less than one; under these circumstances the disease will die out: witness, for example, the disappearance of diphtheria from communities in which around 75% of the children have been immunized (Figure 12.2). But this figure must be maintained; there is no room for complacency. In contrast, focal outbreaks of measles have occurred in communities that object to immunization on religious grounds, raising an important point for parents in general. Each individual must compare any perceived disadvantage associated with vaccination in relation to the increased risk of disease in their unprotected child.

How vaccines work

Vaccines are effective because of adaptive immunity and immune memory. Antibody memory exists in two compartments. First as pre-existing antibody in the blood and tissues ready to attack

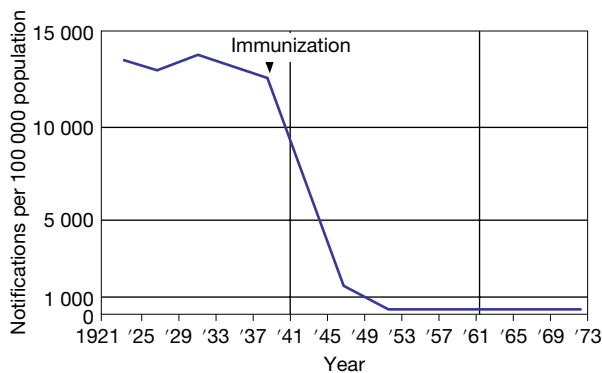


Figure 12.2 Notification of diphtheria in England and Wales per 100 000 population showing dramatic fall after immunization. (Source: Dick G. (1978) *Immunisation*. Update Books. Reproduced with permission of Springer.)

the pathogen without cellular triggering – this is probably the most powerful first line of defense against exposure to many pathogens. This antibody can be maintained at relatively high levels for many years, probably produced by long-lived plasma cells in the bone marrow, although this is not universally accepted. In a sense, the most crucial part of antibody “memory” might be equated with the long life of these plasma cells. However, the second form of the antibody memory component, memory B-cells, might also be crucial for vaccine-mediated protection in some cases. In this case, contact with pathogen stimulates B-cells to proliferate and differentiate to produce copious amounts of antibody. Equally, the contact of memory B-cells with pathogen might be important to boost plasma cell numbers and serum antibody concentrations for the next encounter with the pathogen. T-cell memory also exists in two compartments. Effector memory T-cells are found in peripheral tissues where they can respond immediately to pathogen-infected cell contact with effector activities. Central memory T-cells are found mainly in lymph nodes, where they can respond to pathogen contact with expansion and differentiation to effectors. T-cell memory consists of both CD8⁺ and CD4⁺ T-cell responses. Clearly T-cell responses are most pertinent to virus, parasite, and intracellular bacterial infections.

The best correlate of protection for many current vaccines is antibody and it is likely that antibody is the most important mechanism of vaccine-induced resistance to disease. This is consistent with the notion that T-cells are the largest contribution to viral immunity during primary infection and antibodies during secondary infection (Figure 12.3). However, it is important to note that the mechanisms of vaccine protection may vary widely between different pathogens, different individuals, different doses of pathogen to which the individual is exposed and different routes of exposure.

In addition to an ability to engender effective immunity, a number of crucial conditions must be satisfied for a vaccine to be considered successful (Table 12.2). The antigens must be readily available, and the preparation should be stable, cheap, and certainly safe, bearing in mind that the recipients are most often healthy children. Clearly, the first contact with antigen during vaccination should not be injurious and the maneuver is to avoid the pathogenic effects of infection, while maintaining protective immunogens.

The primary approaches to the generation of existing vaccines are shown in Figure 12.4. and these are now considered in turn.

Killed organisms as vaccines

The simplest way to destroy the ability of microbes to cause disease yet maintain their antigenic constitution is to prevent their replication by killing in an appropriate manner. Parasitic worms and, to a lesser extent, protozoa are extremely difficult to grow up in bulk to manufacture killed vaccines. This problem does not arise for many bacteria and viruses

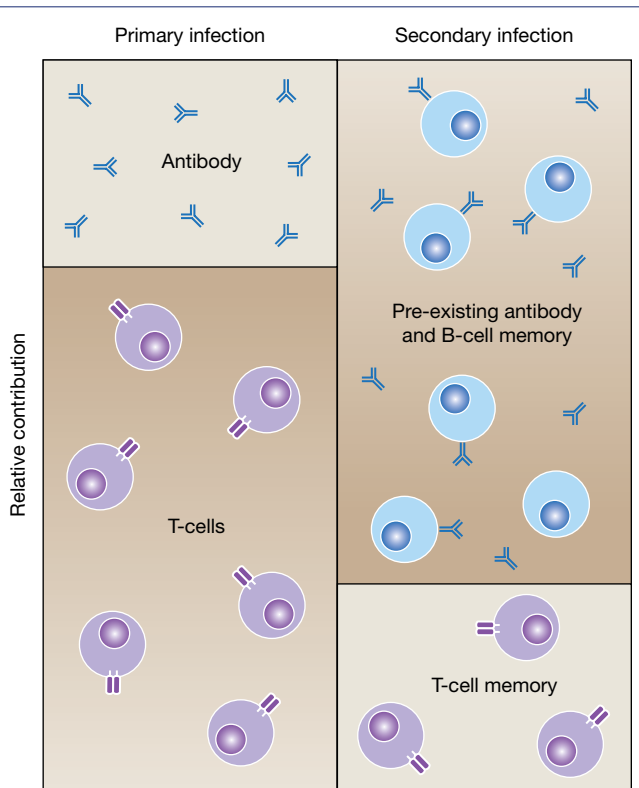


Figure 12.3 A schematic view of the relative contributions of humoral and cellular immunity during primary or secondary viral infection. During primary viral infection, antiviral T-cell responses are critical for reducing viral replication in addition to contributing to the development of an effective antibody response. Primary T-cell-dependent antibody responses are mounted during the course of infection and take time to undergo immunoglobulin class-switching and somatic hypermutation to possibly provide assistance to virus-specific T-cells in resolving the infection. Following recovery from primary infection (or after vaccination), persisting virus-specific antibody represents the first line of defense against secondary infection. If secondary infection does occur, then circulating antibodies and presumably memory B-cells that proliferate and differentiate into antibody-secreting cells will reduce virus dissemination and allow time for the development of an antiviral T-cell response. Memory B-cells are highly efficient at presenting specific antigen and therefore may also be involved with more rapid and efficient presentation to T-cells as well. Pre-existing T-cell memory will also play a role in protection against secondary infection. However, even if T-cell memory has declined or is lost, the long-term maintenance of antiviral antibody responses will suppress virus replication until a new virus-specific T-cell response is mounted from the naive repertoire. (Adapted from Amanna I.J. and Slifka M.K. (2009) *Antiviral Research* **84**, 119–130.)

and, in these cases, the inactivated microorganisms have provided a number of safe antigens for immunization. Examples are influenza, cholera, and inactivated poliomyelitis (Salk) vaccines (Figure 12.5). Care has to be taken to ensure that important protective antigens are not destroyed in the inactivation process.

Table 12.2 Factors required for a successful vaccine.

Factor	Requirements
Efficacy	Must evoke protective levels of immunity: at the appropriate site of relevant nature (Ab, CD4 T-cell and CD8 T-cell) of adequate duration
Availability	Readily cultured in bulk or accessible source of subunit
Stability	Stable under extreme climatic conditions, preferably not requiring refrigeration
Affordability	Must be priced to allow use in developing countries
Safety	Eliminate any pathogenicity

Live attenuated organisms have many advantages as vaccines

The objective of attenuation is to produce a modified organism that mimics the natural behavior of the original microbe without causing significant disease. In many instances the immunity conferred by killed vaccines, even when given with adjuvant, is often inferior to that resulting from infection with live organisms. This is presumably because the replication of the living microbes confronts the host with a **larger and more sustained dose of antigen** and that, with budding viruses, infected cells are required for the establishment of good **cytotoxic T-cell memory**. Another significant advantage of using live organisms is that the immune **response takes place largely at the site of the natural infection**. This is well illustrated by the nasopharyngeal IgA response to immunization with polio vaccine. In contrast to the ineffectiveness of parenteral injection of killed vaccine, intranasal administration evoked a good local antibody response. However, whereas this response declined over a period of 2 months or so, per oral immunization with live attenuated virus established a persistently high IgA antibody level (Figure 12.6).

There is, in fact, a strong upsurge of interest in strategies for mucosal immunization. The mucosal immune system involves mucous membranes covering the aerodigestive and urogenital tracts as well as the conjunctiva, the ear, and the ducts of all exocrine glands, whose protection includes SIgA antibodies.

Classical methods of attenuation

The objective of attenuation, that of producing an organism that causes only a very mild form of the natural disease, can be equally well attained if one can identify heterologous strains that are virulent for another species, but avirulent in humans. The best example of this was Jenner's seminal demonstration that cowpox would protect against smallpox. Subsequently, a

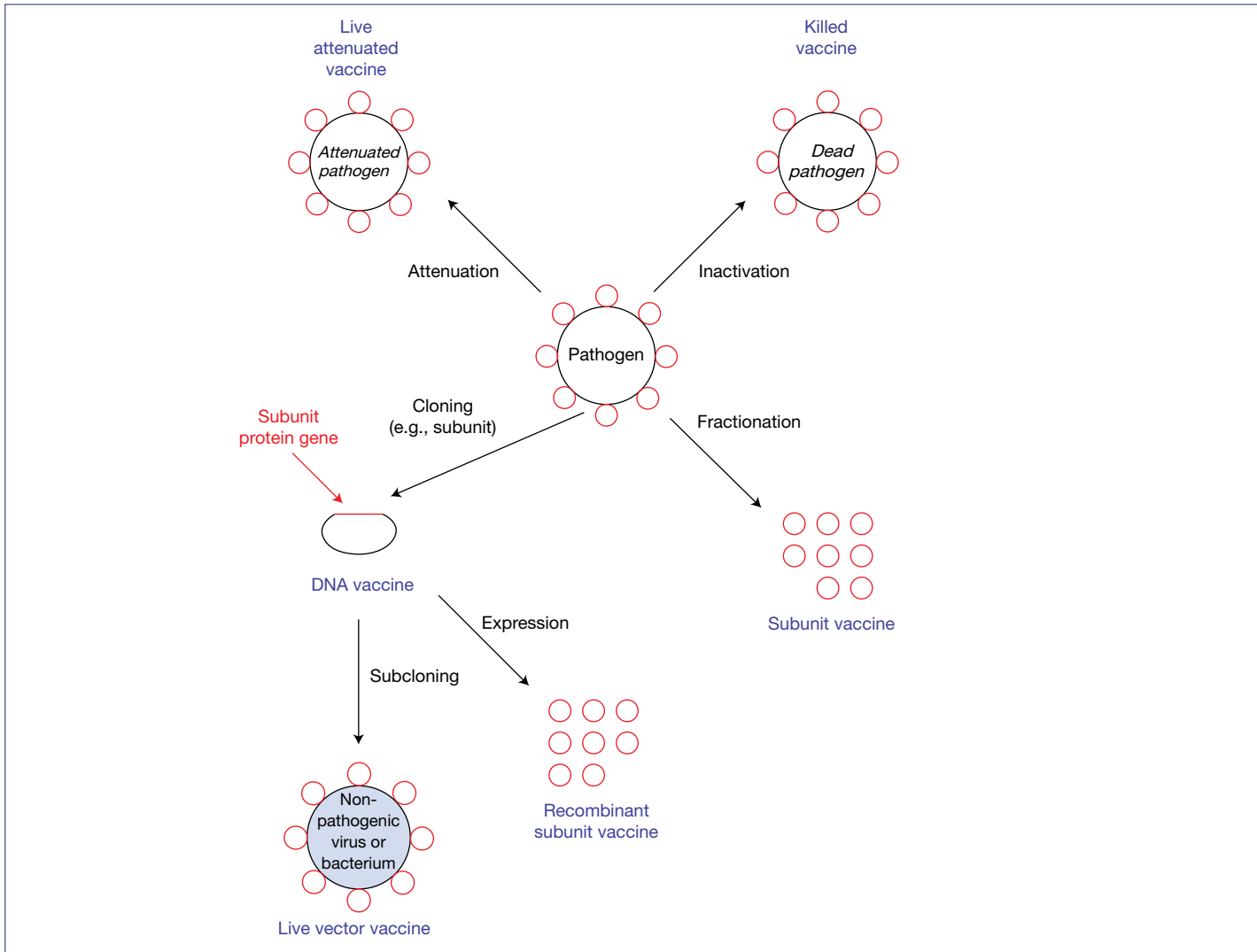


Figure 12.4 Classical vaccine approaches.

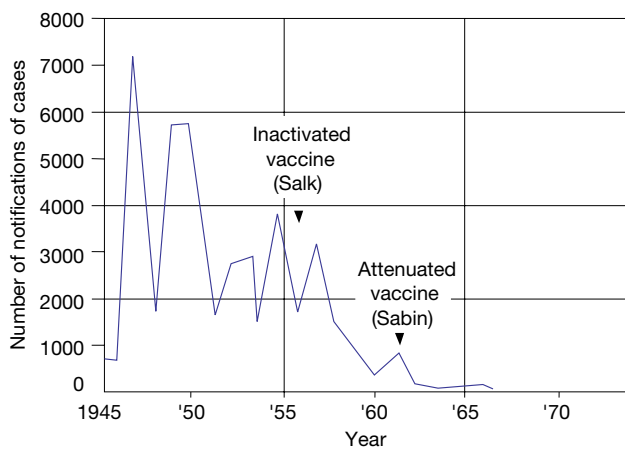


Figure 12.5 Notifications of paralytic poliomyelitis in England and Wales showing the beneficial effects of community immunization with killed and live vaccines. (Source: Dick G. (1978) *Immunisation*. Update Books. Reproduced with permission of Springer.)

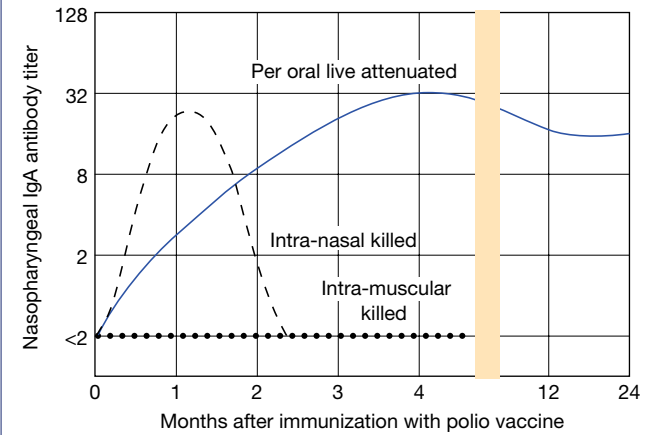


Figure 12.6 Local IgA response to polio vaccine. Local secretory antibody synthesis is confined to the specific anatomical sites that have been directly stimulated by contact with antigen. (Data source: Ogra P.L. *et al.* (1975). In *Viral Immunology and Immunopathology* (ed. Notkins A.L.). Academic Press, New York, p. 67.)

truly remarkable global effort by the World Health Organization (WHO), combining extensive vaccination and selective epidemiological control methods, **completely eradicated smallpox as a human disease** – a wonderful achievement. Thus, although 300 million people are estimated to have died of smallpox in the twentieth century, nobody has died of the virus since 1978. Emboldened by this success, the WHO embarked upon a program to eradicate polio using attenuated polio vaccine to block transmission of the virus and, despite setbacks, it is hoped that this goal will be achieved in the not too distant future. One can even follow the progress of this campaign on <http://www.polioeradication.org>.

Attenuation itself was originally achieved by empirical modification of the conditions under which an organism grows. Louis Pasteur first achieved the production of live but nonvirulent forms of chicken cholera bacillus and anthrax (see Milestone 12.1) by such artifices as culture at higher temperatures and under anaerobic conditions, and was able to confer immunity by infection with the attenuated organisms. A virulent strain of *Mycobacterium tuberculosis* became attenuated by chance in 1908 when Albert Calmette and Camille Guérin at the Institut Pasteur, Lille, France added bile to the culture medium in an attempt to achieve dispersed growth. After 13 years of culture in bile-containing medium, the strain remained attenuated and was used successfully to vaccinate children against tuberculosis. The same organism, BCG (bacille Calmette–Guérin), is widely used today in many countries for the immunization of infants and of tuberculin-negative children and adolescents. However, its efficacy varies widely from, for example, protection in 80% of vaccinated individuals in the United Kingdom, to a total lack of efficacy in Southern India. This variability is not fully understood, but is thought to be due to a number of factors including local differences in the antigenic composition of the vaccine and in the environmental mycobacterial strains, and differences in MHC alleles and other genetic factors in the various human populations.

Attenuation by cold adaptation has been applied to influenza and other respiratory viruses; the organism can grow at the lower temperatures (32–34°C) of the upper respiratory tract, but fails to produce clinical disease because of its inability to replicate in the lower respiratory tract (37°C). An intranasal vaccine containing cold-adapted attenuated influenza virus strains was licensed for use in the United States in 2003.

Attenuation by recombinant DNA technology

It must be said that many of the classical methods of attenuation are somewhat empirical and the outcome is difficult to control or predict. With knowledge of the genetic makeup of these microorganisms, we can apply the molecular biologist's delicate scalpel to deliberately target the alterations that are needed for successful attenuation. Thus genetic recombination is being used to develop various attenuated strains of viruses, such as influenza, with not only a lower virulence for humans but also an increased multiplication rate in eggs

(enabling newly endemic strains of influenza to be adapted for rapid vaccine production).

The **tropism** of attenuated organisms for **the site** at which **natural infection** occurs is likely to be exploited dramatically in the near future to establish gut immunity to typhoid and cholera using attenuated forms of *Salmonella typhi* and *Vibrio cholerae* in which the virulence genes have been identified and modified by genetic engineering.

Microbial vectors as vaccines

An ingenious trick is to use a nonpathogenic virus as a Trojan horse for genes encoding proteins of a pathogen. Incorporation of such “foreign” genes into attenuated recombinant viral vectors, such as fowlpox and canarypox virus and the modified vaccinia Ankara (MVA) strain virus that infect mammalian hosts, but are unable to replicate effectively, provides a powerful vaccination strategy with many benefits. The genes may be derived from organisms that are difficult to grow or inherently dangerous, and the constructs themselves are replication deficient, non-integrating, stable, and relatively easy to prepare. The proteins encoded by these genes are appropriately expressed *in vivo* with respect to glycosylation and secretion, and are processed for MHC presentation by the infected cells, thus effectively endowing the host with both humoral and cell-mediated immunity.

A wide variety of genes have been expressed in vaccinia virus vectors, and it has been demonstrated that the products of genes coding for viral envelope proteins, such as influenza virus hemagglutinin, vesicular stomatitis virus glycoprotein, HIV-1 gp120, and herpes simplex virus glycoprotein D, could be correctly processed. Hepatitis B surface antigen (HBsAg) was secreted from recombinant vaccinia virus-infected cells as the characteristic 22 nm particles (Figure 12.7). Using this approach, chimpanzees have been protected against the clinical effects of hepatitis B virus and mice that were inoculated with recombinant influenza hemagglutinin generated cytotoxic T-cells and were protected against influenza infection.

Attention has also been paid to BCG as a vehicle for antigens required to evoke CD4-mediated T-cell immunity. The organism is avirulent, has a low frequency of serious complications, can be administered any time after birth, has strong adjuvant properties and gives long-lasting cell-mediated immunity after a single injection.

The ability of *Salmonella* to elicit **mucosal responses by oral immunization** has been exploited in the design of vectors that allow the expression of any protein antigen linked to *E. coli* enterotoxin, a powerful mucosal immunostimulant. There is a possibility that the oral route of vaccination may be applicable not only for the establishment of gut mucosal immunity but also for providing systemic protection. For example, *Salmonella typhimurium* not only invades the mucosal lining of the gut, but also infects cells of the mononuclear phagocyte system throughout the body, thereby stimulating the production of humoral and secretory antibodies as

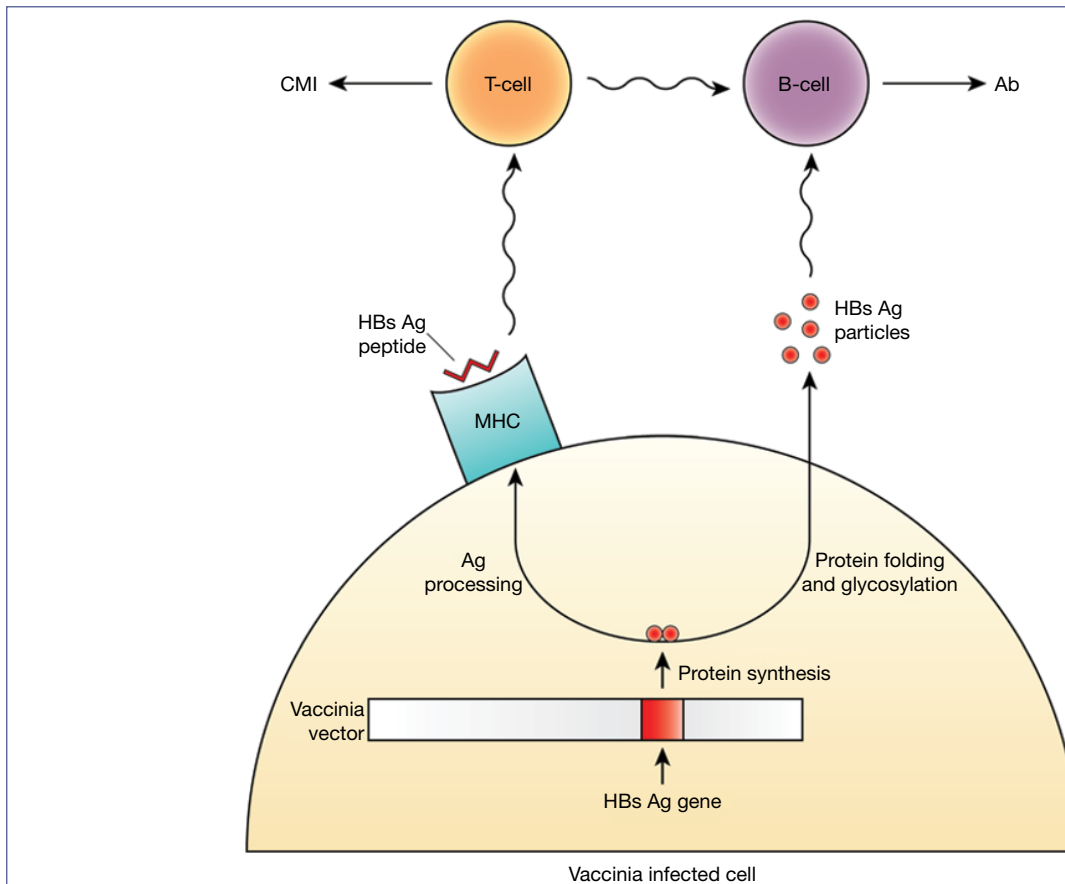


Figure 12.7 Hepatitis B surface antigen (HBsAg) vaccine using an attenuated vaccinia virus carrier. The HBsAg protein is synthesized by the machinery of the host cell: some is secreted to form the HBsAg 22 nm particle that stimulates antibody (Ab) production, and some follows the antigen processing pathway to stimulate cell-mediated immunity (CMI) and T-helper activity.

well as CD4⁺ and CD8⁺ T-cell-mediated immunity. As attenuated *Salmonella* can be made to express proteins from *Shigella*, cholera, malaria sporozoites, and so on, it is feasible to consider these as potential oral vaccines. *Salmonella* may also carry “foreign genes” within separate DNA plasmids and, after phagocytosis by antigen-presenting cells, the plasmids can be released from the phagosome into the cytosol if the plasmid bears a recombinant listeriolysin gene or the bacterium is a mutant whose cell walls disintegrate within the phagosome; the plasmid then moves to the nucleus where it is transcribed to produce the desired antigen. Quite strikingly, these attenuated organisms are very effective when inhaled and can elicit substantive mucosal and systemic immune responses comparable with those obtained by the parenteral route.

Constraints on the use of attenuated vaccines

Attenuated vaccines for poliomyelitis (Sabin), measles, mumps, rubella, varicella-zoster, and yellow fever have gained general acceptance. However, with live viral vaccines there is a possibility that the nucleic acid might be incorporated into the host's genome or that there may be reversion to a virulent form.

Reversion is less likely if the attenuated strains contain several mutations. Another disadvantage of attenuated strains is the difficulty and expense of maintaining appropriate cold-storage facilities, especially in out-of-the-way places. In diseases such as viral hepatitis, AIDS, and cancer, the dangers associated with live vaccines are daunting. With most vaccines there is a very small, but still real, risk of developing complications and it cannot be emphasized too often that this **risk must be balanced against the expected chance of contracting the disease with its own complications**. Where this is minimal, some may prefer to avoid general vaccination and to rely upon a crash course, backed up if necessary by passive immunization in the localities around isolated outbreaks of infectious disease.

It is important to recognize those children with immunodeficiency before injection of live organisms; a child with impaired T-cell reactivity can become overwhelmed by BCG and die. It is also inadvisable to give live vaccines to patients being treated with steroids, immunosuppressive drugs, or radiotherapy or who have malignant conditions such as lymphoma and leukemia; pregnant mothers must also be included here because of the vulnerability of the fetus.

Use in a veterinary context

For veterinary use, of course, there is a little less concern about minor side-effects and excellent results have been obtained using existing vaccinia strains with rinderpest in cattle and rabies in foxes, for example. In the latter case, a recombinant vaccinia virus vaccine expressing the rabies surface glycoprotein was distributed with bait from the air and immunized approximately 80% of the foxes in that area. No cases of rabies were subsequently seen, but epidemiological considerations indicate that because of the higher fox density this leads to a higher percentage have to be made immune; thus, either the efficacy of the vaccine must be increased or culling of the animals must continue – an interesting consequence of interference with ecosystems. Less complicated is the use of such immunization to control local outbreaks of rabies in rare mammalian species, such as the African wild dog, which are threatened with extinction by the virus in certain game reserves.

Subunit vaccines

A whole pathogen usually contains many antigens that are not concerned in the protective response of the host but may give rise to problems by suppressing the response to protective antigens or by provoking hypersensitivity, as we saw in the last chapter. Vaccination with the isolated protective antigens may avoid these complications, and identification of these antigens then opens up the possibility of producing them synthetically under circumstances in which bulk growth of the organism is impractical or isolation of the individual components too expensive.

The use of purified components as bacterial vaccines

Bacterial exotoxins such as those produced by diphtheria and tetanus bacilli have long been used as immunogens. First, they

must of course be detoxified and this may be achieved by formaldehyde treatment when this does not destroy the major immunogenic determinants (Figure 12.8). Immunization with the *toxoid* will, therefore, provoke the formation of protective antibodies, which neutralize the toxin by stereochemically blocking the active site, and encourage removal by phagocytic cells. The toxoid is generally given after adsorption to aluminum hydroxide, which acts as an adjuvant and produces higher antibody titers. In addition to their use as vaccines to generate a protective antibody response against tetanus and diphtheria, the toxoids are often conjugated to other proteins, peptides, or polysaccharides to provide helper T-cell epitopes for these antigens. Nontoxic variants of the toxins themselves, such as the CRM197 variant of diphtheria toxin, can also be used to provide helper T-cell epitopes for antigens such as the *Haemophilus influenzae* type b (Hib) polysaccharide.

A viral subunit vaccine: hepatitis B virus (HBV)

In 1965, Baruch Blumberg first described an antigen in the blood of Australian aborigines associated with hepatitis. This “Australia antigen” was subsequently shown to be a particle formed from the surface antigen of hepatitis B virus. Initially, antigen particles were isolated from the plasma of HBV carriers and inactivated and used as a vaccine. Later, the particles were prepared in yeast. The HBV subunit vaccine was a milestone in vaccinology as it was the first manufactured using recombinant DNA technology. One very interesting facet of this vaccine is that it was originally used for small at-risk groups exposed to blood products such as doctors and nurses. Later, it became very widely used, including in the developing world. As HBV is associated with hepatic cancer and more than 300 million people are infected worldwide, the HBV vaccine represents the first to prevent cancer on a large scale.

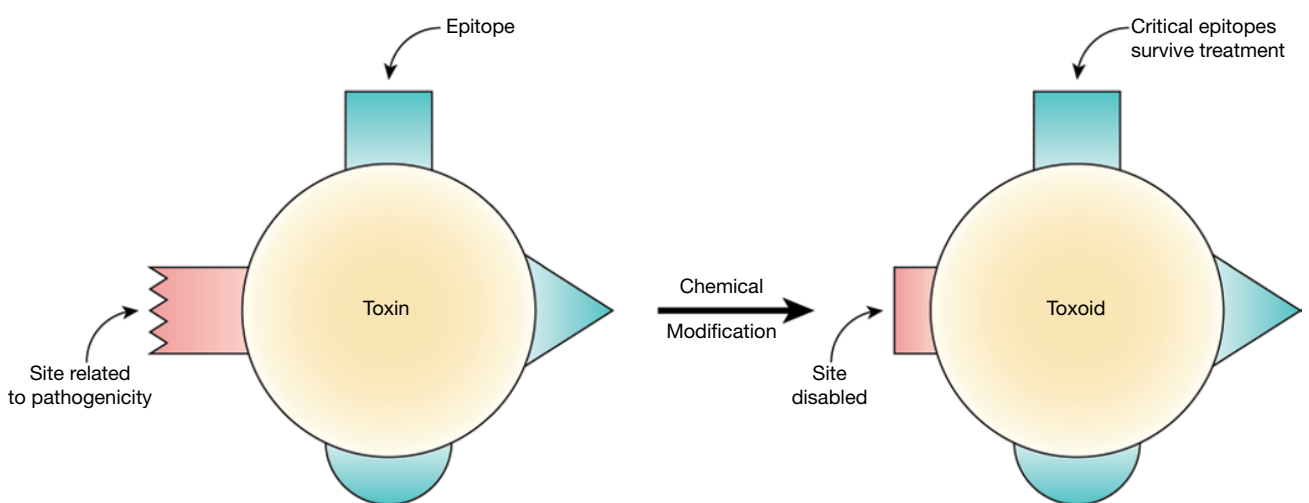


Figure 12.8 Modification of toxin to harmless toxoid without losing many of the antigenic determinants. Antibodies generated in response to the toxoid react well with the original toxin and lead to its clearance.

Carbohydrate vaccines

The dense surface distribution of characteristic glycan structures on diverse pathogens and on malignant cells makes carbohydrates attractive antibody-based vaccine targets. However, the nature of glycans presents some severe problems in terms of the induction of protective antibodies. First, glycans tend to be poorly immunogenic. They should be coupled to a carrier protein to provide a source of CD4⁺ T-cell help. Second, anti-glycan antibodies typically have low affinities relative to anti-protein antibodies. They rely heavily on avidity effects to achieve binding at physiological concentrations. Third, glycans are typically heterogeneous on target pathogens or cells and therefore the efficacy of any specific anti-glycan response is diluted. Nevertheless, glycoconjugates are increasingly being designed (Figure 12.9) as vaccine candidates. Licensed carbohydrate vaccines include those against *Haemophilus influenzae* type b (Hib), *Neisseria meningitidis*, *Salmonella typhi*, and *Streptococcus pneumoniae*.

DNA and RNA vaccines

Teams working with J. Wolff and P. Felgner experimented with a new strategy for gene therapy that involved binding the negatively charged DNA to cationic lipids, which would themselves attach to the negatively charged surface of living cells and then presumably gain entry. The surprise was that controls injected with DNA without the lipids actually showed an ***even higher uptake of DNA*** and expression of the protein it encoded, so giving rise to the whole new technology of ***DNA vaccination or genetic immunization***. It was quickly appreciated that the injected DNA functions as a source of immunogen *in situ* and can induce strong immune responses, particularly cellular immune responses. The DNA used in this procedure is sometimes referred to as ***naked DNA*** to reflect the fact that the nucleic acid is stripped bare of its associated proteins.

The transcription unit composed of the cDNA gene with a poly A terminator is stitched in place in a DNA plasmid with a promoter such as that from cytomegalovirus and a CpG bacterial sequence as an adjuvant. It is usually injected into muscle where it can give prolonged expression of protein. The pivotal cell is the dendritic antigen-presenting cell that may be transfected directly, could endocytose soluble antigen secreted by the muscle cells into the interstitial spaces of the muscle, and could take up cells that have been killed or injured by the vaccine. The CpG immunostimulatory sequences engage Toll-like receptor 9 (TLR9) and thereby provoke the synthesis of IFN α and β , IL-12, and IL-18, which promote the formation of T-helper (Th)1 cells; this in turn generates good cell-mediated immunity, helps the B-cell synthesis of certain antibody classes (e.g., IgG2a in the mouse), and induces good cytotoxic T-cell responses, presumably reflecting the cytosolic expression of the protein and its processing in the MHC class I pathway.

Let us look at an example. It will be recalled that frequent point mutations (drift) in the gene encoding influenza surface hemagglutinin give rise to substantial antigenic variation, whereas the major internal proteins, which elicit T-cell-mediated immunity responses, have been relatively conserved. On this line of reasoning, nucleoprotein DNA should give broad T-cell protection against other influenza strains and indeed it does (Figure 12.10). A combination of DNAs encoding the hemagglutinin (included only for statutory reasons) and nucleoprotein genes gave nonhuman primates and ferrets good protection against infection, and protected ferrets against challenge with an antigenically distinct epidemic human virus strain more effectively than the contemporary clinically licensed vaccine. Vaccination can also be achieved by coating the plasmids onto minute gold particles or cationic poly (lactide co-glycolide) (PLG) microparticles and shooting them into skin epidermal cells by the high-pressure “biolistic” helium gun, a technique that uses between 10- and 100-fold less plasmid DNA than the muscle injection.

To date, straightforward DNA vaccination has not been as successful in humans or nonhuman primates as in mice. Nevertheless the many potential advantages of the approach, including its simplicity and ease of quality control for example, mean that many efforts on improving DNA vaccination in humans have and are being explored. One is a “prime–boost” protocol. The persistent but low level of expression of the protein antigen by DNA vaccines establishes a pool of relatively high-affinity memory B-cells that can readily be revealed by boosting with protein antigen (Figure 12.11). This has given rise to a prime–boost strategy in which these memory cells are expanded by boosting with a non-replicating viral vector, such as fowlpox virus or Ankara strain-modified vaccinia virus, bearing a gene encoding the antigen. Mice immunized in this fashion with influenza virus hemagglutinin produced satisfyingly high levels of IgG2a antibody and were protected against challenge with live virus. Remarkably, up to 30% of circulating CD8 T-cells were specific for the immunizing epitope as shown by MHC class I tetramer binding. A similar strategy with *Plasmodium berghei* produced high levels of peptide-specific CD8 T-cells secreting IFN γ , which protected against challenge by sporozoites.

Recently, considerable excitement has focused on RNA vaccines, which have several major advantages over DNA. First, RNA needs only to be delivered into the cytoplasm of the host cell to be translated into protein, whereas DNA must first be transcribed into mRNA in the nucleus, before back into the cytoplasm for translation. Second, the safety concerns associated with potential integration of DNA into host chromosomes is absent for RNA. Third, RNA can have a very strong adjuvant effect by triggering innate responses that can lead eventually to more effective adaptive immune responses. The major disadvantage that has classically been associated with RNA is its very low stability compared to

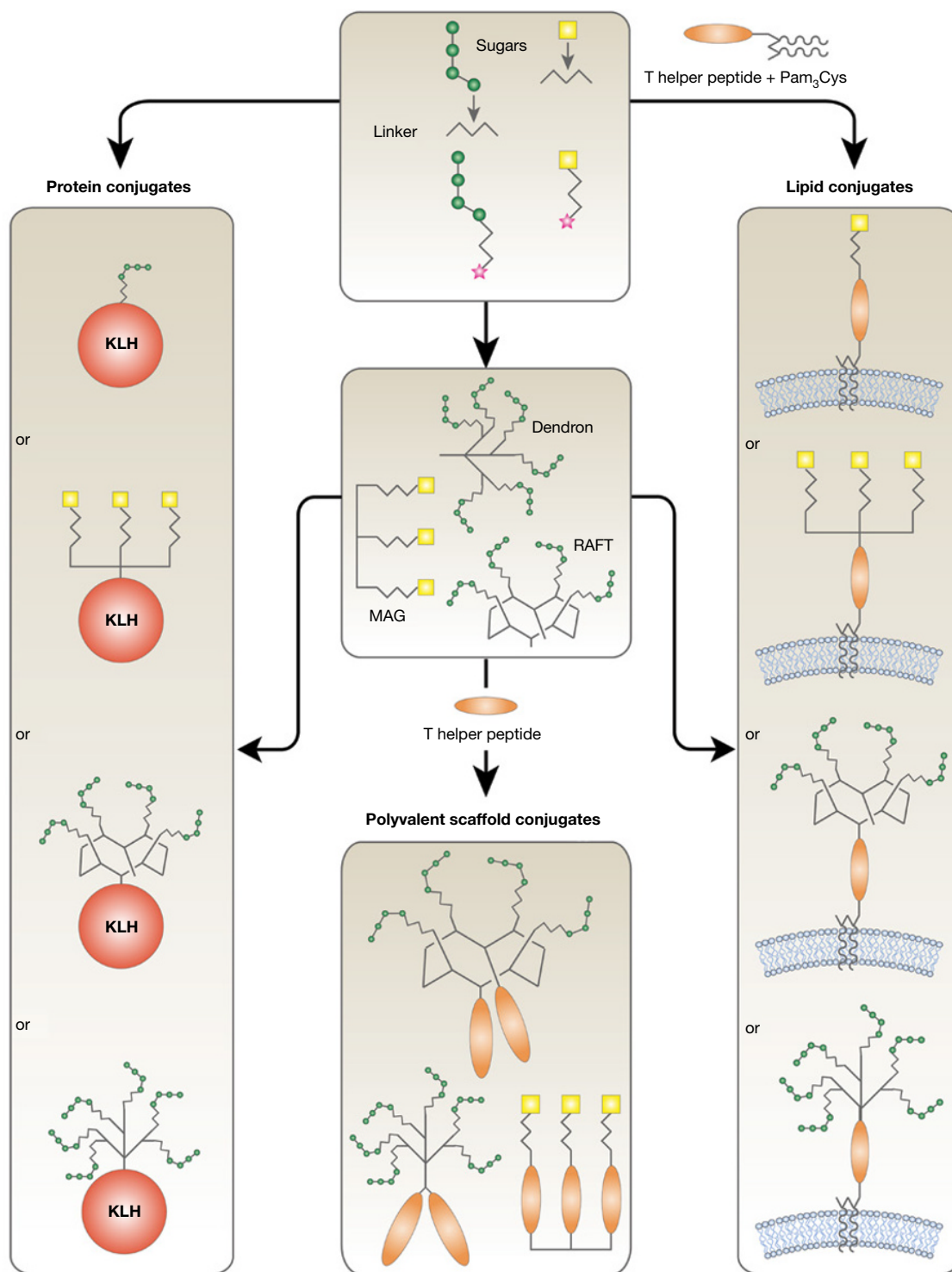


Figure 12.9 Schematic representation of glycoconjugate immunogen design. Starting from activated glycans (star denotes activated group) from natural or synthetic sources, the production of three categories of glycoconjugate immunogens is shown: protein conjugates, lipid conjugates, and polyvalent scaffold conjugates. The requirement for both polyvalent display and helper T-cell epitopes, crucial for achieving strong, long-lasting, and class-switched antibody responses, are satisfied in each category. For protein conjugates (left-hand panel), activated glycans are covalently attached to immunogenic protein carriers (e.g., keyhole limpet hemocyanin [KLH]), which provide helper T-cell epitopes and enable polyvalent display. Lipid conjugates (right hand panel) made by covalent linkage of activated glycans to helper T-cell peptides attached to lipid moieties allow polyvalency through formulation into lipid membranes. In addition, activated glycans may first be conjugated to synthetic polyvalent scaffolds (e.g., dendron, multiple antigen glycopeptide [MAG], and regioselectively addressable functionalized template [RAFT]) (middle panel), which may then be used to make protein and lipid conjugates. Alternatively, polyvalent scaffold conjugates may be made through addition of helper T-cell peptides alone. Adjuvants are usually included in the final glycoconjugate vaccine formulations (e.g., alum or QS-21). Note that tripalmitoyl-S-glycerol-cysteinyserine (Pam₃Cys) has adjuvant properties. (Source: Astronomo R.D. and Burton D.R. (2010) *Nature Reviews Drug Discovery* 9, 308–324. Reproduced with permission of Nature Publishing Group.)

DNA. However, recent advances in formulation and delivery have largely overcome these disadvantages. There are two principal forms of RNA vaccine: (i) conventional, non-amplifying mRNA and (ii) RNA replicons engineered from the genomes of positive-strand RNA viruses, especially alphaviruses such as Sindbis, Semliki Forest, and Venezuelan equine encephalitis (VEE) viruses. The conventional

approach requires high doses of mRNA to achieve good levels of antigen although optimization protocols have helped. The great strength of the second approach is that amplification of RNA (self-amplifying mRNA [SAM]) occurs within host cells to generate large amounts of antigen. Proof of concept of RNA vaccines has now been demonstrated in a number of animal models and many predict this will be a key vaccine platform for the future.

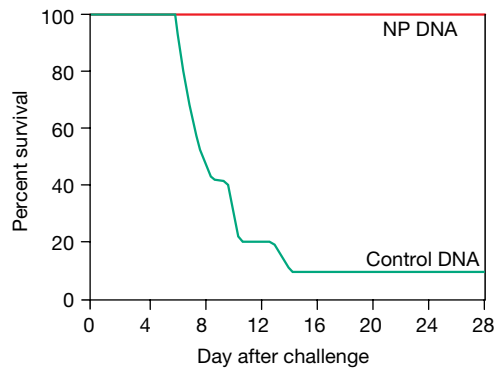


Figure 12.10 Protection from cross-strain influenza challenge after vaccination with nucleoprotein DNA. Mice were immunized three times at 3-week intervals with 200 mg of nucleoprotein (NP) or vector (control) DNA and lethally challenged with a heterologous influenza strain 3 weeks after the last immunization. Survival of mice given NP DNA was significantly higher than in mice receiving vector ($p = 0.0005$). (Data source: Liu M.A. *et al.* (1993) *DNA and Cell Biology* 12, 777–783.)

Newer approaches to vaccine development

Conventional vaccines, which have been enormously successful against a range of pathogens, can be described as following a “simple mimicry” strategy going back to the work of Jenner and Pasteur. The essential strategy is to use attenuated or killed pathogens, with the occasional use of purified or recombinant subunits. These vaccines mostly target pathogens that have very little antigenic diversity and appear to be largely dependent on antibody-based protection. The conventional approach has tended to find much less success for a range of other pathogens, notably those showing considerable antigenic diversity or for which T-cell immunity may be of greater protective import (Figure 12.12). For example consider HIV. A live attenuated vaccine protects monkeys against challenge with the same strain of SIV (simian immunodeficiency virus, the monkey equivalent of HIV) but is far less effective against other strains of SIV. For

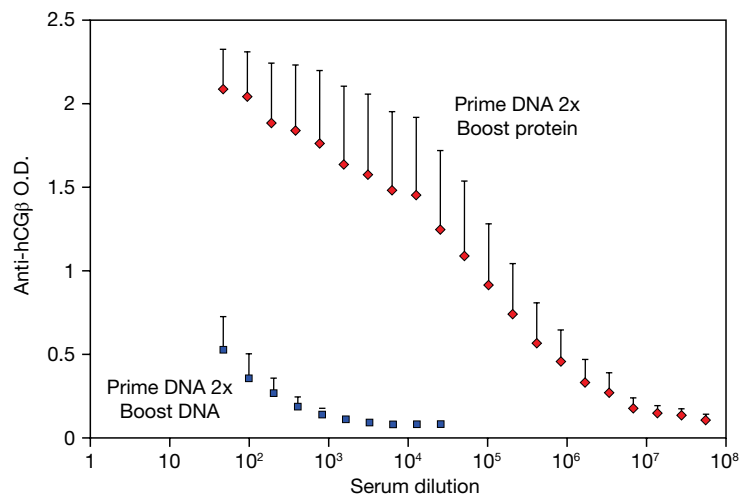


Figure 12.11 Induction of memory cells by DNA vaccine and boost of antibody production with the protein immunogen, human chorionic gonadotropin β -chain (hCG β). Groups of five (C57BL/6 \times BALB/c)F1 mice each received 50 mg of the hCG β DNA plasmid at weeks 0 and 2; one group received a further injection of the plasmid, while the other was boosted with 5 mg of the hCG β protein antigen in Ribi adjuvant. Dilutions of serum were tested for antibodies to hCG β by indirect ELISA. Mean titers + SE are shown. (Data source: Laylor R. *et al.* (1999) *Clinical and Experimental Immunology* 117, 106.)

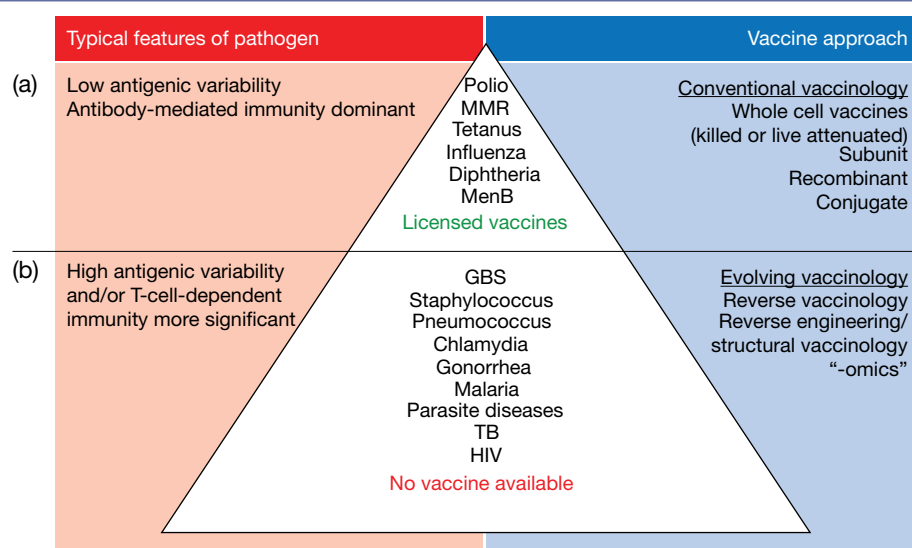


Figure 12.12 Schematic view of conventional vaccinology and evolving vaccinology in the post-genome era. (a) Most licensed vaccines target pathogens that have low antigenic variability and pathogens for which protection depends on antibody-mediated immunity. These vaccines have typically been developed using conventional vaccinology. (b) Several pathogens are shown for which no vaccine is available, owing to either their high antigenic variability and/or the need to induce T-cell-dependent immunity to elicit protection. New approaches are being applied to vaccine development for these pathogens in the post-genome era. Vaccines/diseases shown in the figure are selected examples of each category and are not a complete list. MenB is the first example of a vaccine that is now licensed that was generated by reverse vaccinology (Figure 12.13). TB, *Mycobacterium tuberculosis*; MMR, mumps, measles, rubella; MenB, meningitis B; GBS, group B *Streptococcus*. (Data source: Rinuado C.D. *et al.* (2009) *Journal of Clinical Investigation* **9**, 2515–2525.)

a human vaccine against HIV to be effective clearly it should protect against the majority of circulating global viral strains. Killed and subunit vaccines against HIV/SIV tend to be ineffective because of the enormous variability and instability of the surface envelope proteins (see also Chapter 13). Another highly problematical disease for vaccine development is tuberculosis; immunity to this intracellular pathogen is likely to involve T-cell rather than antibody-based protective activities.

In recent years, vaccine development has increasingly turned to the tools of modern molecular biology. For bacterial vaccines, the rise of genomics has been crucial. At least one complete sequence is now available for all of the major human pathogens. This has facilitated the development of “reverse vaccinology,” championed by Rino Rappuoli and colleagues. The essential strategy identifies the complete repertoire of bacterial surface antigens, investigates the ability of antigens to elicit immunity in animal models, and then designs a combination of antigens to be used in the vaccine. This elegant approach is illustrated in Figure 12.13 for the successful development of a vaccine to serogroup B *Neisseria meningitidis* (MenB), which is the most common cause of meningococcal disease in the developed world and had defied conventional vaccine approaches for decades.

Highly variable viruses such as HIV and hepatitis C virus (HCV) also provide severe vaccine development problems. Here one of the approaches being adopted can be described as reverse engineering or structural vaccinology. Thus broadly neutralizing antibodies capable of acting against a wide spectrum of global isolates as required by a vaccine have been described in natural infection and are being studied in terms of their interaction with surface envelope proteins. The notion is that the molecular information gained can be used to modify envelope proteins or to design novel immunogens that can be used as vaccines to elicit broadly neutralizing antibodies. This same concept might provide a universal influenza vaccine that would protect against most or all subtypes and strains of flu and obviate the need for annual immunizations. Immunodominance is one of the great problems in developing vaccines to highly variable pathogens (i.e., the pathogen has evolved so that the strongest immune responses tend to be elicited to the most variable regions of the pathogen). A host of strategies are now being explored to try to focus B-cell and T-cell responses onto the most conserved epitopes.

Modern vaccine development will be greatly aided by new technologies for studying immune responses. In particular antibody responses can now be examined at a level of detail that was unimaginable just a few years ago through

MenB vaccine development

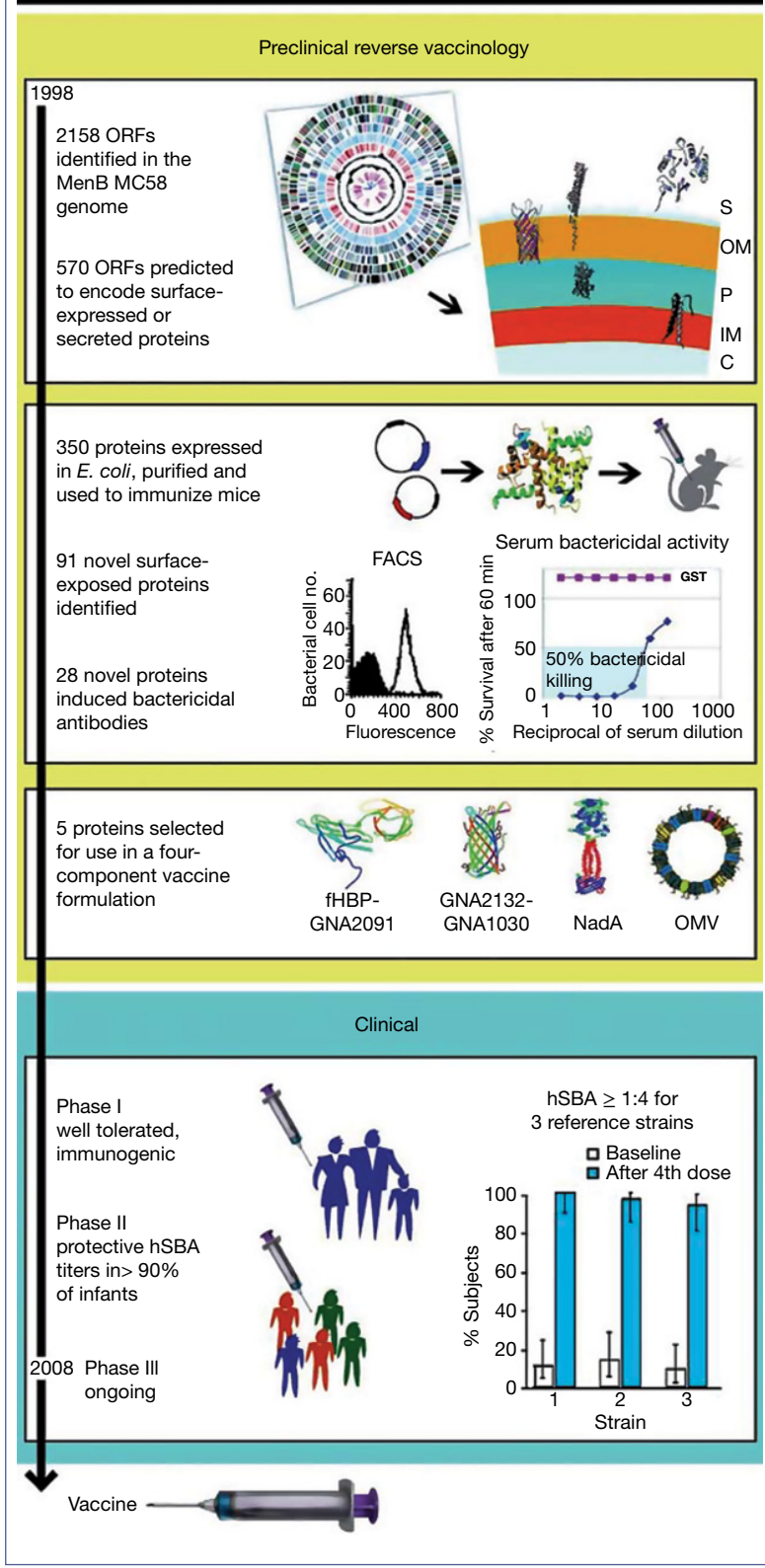


Figure 12.13 MenB vaccine development. Preclinical development was based on a reverse vaccinology approach, in which the genome sequence of the virulent meningitis B (MenB) strain MC58 was used to identify open reading frames (ORFs) predicted to encode proteins that were surface exposed (i.e., secreted [S] or located in the outer membrane [OM]), which were then expressed in *E. coli*, purified, and used to immunize mice. Antibodies generated in mice were then used to confirm surface exposure of the vaccine candidate by fluorescence-activated cell sorting (FACS) and to identify proteins that induced bactericidal activity. This screening process resulted in identification of several novel vaccine candidates, including GNA 1870 (which is fHBP), GNA 1994 (which is NadA), GNA2132, GNA 1030, and GNA2091. The formulation for the comprehensive MenB vaccine consists of four components: fHBP-GNA2091 and GNA2132-GNA1030 fusion proteins, NadA, and OMV from the New Zealand MenZB vaccine strain. Clinical development using this formulation has shown in phase I and II trials that the vaccine is well tolerated and immunogenic. The vaccine induced bactericidal activity using human complement (hSBA) with titers greater than 1:4, which indicates the generation of antibodies able to kill the bacteria at a level that correlates with protection against the bacteria in more than 90% of infants after the fourth dose. This vaccine entered phase III clinical trials in 2008 and was approved for use in Europe in 2013. P, periplasm; IM, inner membrane; C, cytoplasm. (Source: Rinuado C.D. *et al.* (2009) *Journal of Clinical Investigation* 9, 2515–2525. Reproduced with permission of the American Society for Clinical Investigation.)

the advent of next-generation sequencing (NGS) and automated methods for the generation of monoclonal antibodies. Systems vaccinology, the use of the tools of systems biology to help understand and predict immune responses, is also developing rapidly. The use of high-throughput technologies such as microarrays, RNA-seq and mass spectrometry-based proteomics and metabolomics following immunization is critical to systems vaccinology. Overall, technological developments are leading to a new era in rational vaccine design.

Current vaccines

The established vaccines in current use and the schedules for their administration are set out in Table 12.3 and Table 12.4. Regional differences in immunization schedules reflect not only different degrees of perceived risk of infection but also other local considerations. Children under 2 years of age make inadequate responses to the T-independent *H. influenzae* capsular polysaccharide, so they are now routinely immunized with the antigen conjugated with tetanus toxoid or the CRM197 nontoxic variant of diphtheria toxin. The considerable morbidity and mortality associated with hepatitis B infection, its complex epidemiology, and the difficulty in identifying high-risk individuals have led to routine vaccination in the United States from the time of birth. In the United Kingdom, BCG vaccination is routinely given. However, this is not the case in the United States, where the fact that vaccination leads to individuals becoming positive to the Mantoux skin test, thus resulting in an inability to use this test as a means of excluding tuberculosis during the investigation of suspected infection, is seen as too much of a disadvantage. Owing to the constant antigenic drift and occasional antigen shift that occurs with the influenza virus, a new vaccine has to be produced each year for each hemisphere.

Vaccines under development

As with other pharmaceutical agents, the development of vaccines comprises several stages. Successful preclinical studies in animal models are followed by phase I clinical trials in volunteers to initially evaluate safety and the immune response. If all goes well, phase II trials are then carried out in a small number of individuals to gain an indication of efficacy. If the phase II trial is successful, and the company and regulatory authorities decide to proceed, this is followed by a much larger (phase III) study to fully establish efficacy and safety, after which regulatory approval for distribution is given. Phase IV clinical trials finally establish efficacy and safety in large numbers of people.

This whole process may take up to 20 years and cost in excess of US\$500 million.

There are many vaccines currently under development for diseases in which there is at present no vaccine available or where the vaccines that are available are left wanting. **Tuberculosis** is a good example of the latter situation. The BCG vaccine has been in use for over 80 years but is only efficacious in protecting children and adolescents against disseminated and meningeal TB, and then only in some areas of the world, and is largely ineffective against pulmonary TB, which is the commonest form of the disease in adults. Indeed, TB remains a truly major problem in developing countries, and cases have also increased dramatically in Western countries. The alarmingly heightened susceptibility to TB in individuals with HIV/AIDS has led to TB in up to half of HIV-infected individuals, and worldwide multidrug-resistant strains are appearing. This has led to an urgent search for improved vaccine candidates.

Vaccines against parasitic diseases have proved particularly difficult to develop: malaria

Malaria kills more than 600 000 people a year worldwide and leads to illness in hundreds of millions more, most of whom are young children living in sub-Saharan Africa. A major advance in malaria control has been the finding that the impregnation of bed nets with the insecticide pyrethroid reduces *Plasmodium falciparum* deaths by 40%. However, with the emergence of drug-resistant strains of malaria parasites and reports of increasing mosquito resistance to insecticides, vaccines must be developed. The goal seems achievable as, although children are very susceptible, adults resident in highly endemic areas acquire a protective but non-sterilizing immunity possibly mediated by antibodies.

Malaria is a complex mosquito-borne parasitic disease (Figure 12.14). Traditionally, vaccines have targeted a single stage of the infectious cycle. These include the sporozoite (the form with which the host is first infected after a mosquito bite), the liver stage of infection, the blood stage in which red blood cells become infected, and the transmission stage in which gametes are taken up by the mosquito to complete the cycle. One of the problems faced by vaccine developers is the very considerable sequence variation apparent in malarial proteins.

The most investigated and promising malaria vaccine candidate is termed RTS,S (GlaxoSmithKline, GSK) and is being evaluated by GSK in conjunction with the PATH Malaria Vaccine Initiative and the Bill and Melinda Gates Foundation. The “R” stands for the central repeat region of

Table 12.3 Current licensed vaccines for use in the United States and/or Europe.

Vaccine	Antigenic component	Use
Bacterial infections (+ viral in some combinations)		
Anthrax	Alum adsorbed protective antigen (PA) from <i>Bacillus anthracis</i>	Individuals who handle infected animals or animal products. Laboratory staff working with <i>B. anthracis</i>
BCG	Bacillus Calmette–Guérin live attenuated strain of <i>Mycobacterium bovis</i>	Children and adolescents in geographical regions where the vaccine has been shown to be effective, including UK. Not routinely used in the USA
Cholera	Inactivated <i>Vibrio cholerae</i> together with recombinant B-subunit of the cholera toxin	Drinkable oral vaccine for travelers to endemic or epidemic areas
Diphtheria, tetanus, pertussis, poliomyelitis, hepatitis B	Alum-adsorbed diphtheria toxoid, tetanus toxoid, acellular pertussis, inactivated poliomyelitis virus, and recombinant hepatitis B virus surface antigen	Routine immunization of children
Diphtheria, tetanus, pertussis, poliomyelitis, <i>Haemophilus influenzae</i> type b	Another pentavalent combination vaccine, including <i>Haemophilus influenzae</i> type b capsular polysaccharides conjugated to tetanus toxoid or to the CRM197 nontoxic variant of diphtheria toxin	Routine immunization of children
Meningococcal	Conjugate and polysaccharide vaccines for groups A, C, W-135, and Y. Vaccine to group B consists of multiple component	Routine immunization of children in UK
Pneumococcal	Polysaccharide from either each of the 23 or from each of seven capsular types of pneumococcus, conjugated to diphtheria toxoid and adsorbed onto alum	Routine immunization of children (USA). Individuals at risk of pneumococcal infection, e.g., elderly, persons who have undergone splenectomy or with various chronic diseases (UK)
Typhoid fever	Vi polysaccharide antigen of <i>Salmonella typhi</i>	Travelers to countries with poor sanitation, laboratory workers handling specimens from suspected cases
Viral infections		
Hepatitis A	Alum-adsorbed inactivated hepatitis A virus	At-risk individuals, e.g., laboratory staff working with the virus, patients with hemophilia, travelers to high-risk areas
Hepatitis B	Alum-adsorbed recombinant hepatitis B virus surface antigen (HBsAg)	Routine immunization of children (USA). Individuals at high risk of contracting hepatitis B (UK)
Influenza (inactivated)	Inactivated trivalent WHO-recommended strains of influenza virus	Routine immunization of infants (USA). Individuals at high risk of complications from contracting influenza virus (UK)
Influenza (live attenuated)	Attenuated trivalent WHO-recommended strains of influenza virus	Individuals aged 5–49 at high risk of complications from contracting influenza virus
Japanese encephalitis virus	Inactivated Japanese encephalitis virus	Individuals at risk of contracting Japanese encephalitis virus

(Continued on p. 370)

Table 12.3 (Continued)

Vaccine	Antigenic component	Use
Measles, mumps, and rubella (MMR)	Live attenuated measles, mumps, and rubella viruses	Routine immunization of children
Papillomavirus	Virus-like particles	Prophylaxis against human papillomavirus (HPV) infections including prevention of cervical cancer
Polio (Inactivated, Salk)	Inactivated poliovirus types 1, 2, and 3	Routine immunization of children. Protects against polio paralysis but does not prevent spread of wild polio virus (for which the oral polio vaccine [Sabin] containing live attenuated types 1, 2, and 3 virus is used)
Rabies	Inactivated rabies virus	At-risk individuals
Rotavirus	Live attenuated virus	Oral, to prevent rotavirus-associated diarrhea and dehydration in infants
Tick-borne encephalitis	Inactivated tick-borne encephalitis virus	At-risk individuals, e.g., working, walking, or camping in infected areas
Varicella–zoster	Live attenuated varicella–zoster virus	Seronegative healthy children over 1 year old who come into close contact with individuals at high risk of severe varicella infections. Seronegative healthcare workers who come into direct contact with patients. A concentrated attenuated virus vaccine is used to prevent shingles in the elderly
Yellow fever	Live attenuated yellow fever virus	Those traveling or living in areas where infection is endemic, and laboratory staff who handle the virus or clinical samples from suspected cases

Vaccines separately containing the individual components of the polyvalent vaccines are also licensed.

Plasmodium falciparum circumsporozoite protein (CSP); the “T” for the T-cell epitopes of the CSP; and the “S” for hepatitis B surface antigen (HBsAg). These are combined in a single fusion protein (“RTS”) and co-expressed in yeast cells with free HBsAg. The RTS fusion protein and free “S” protein spontaneously assemble into RTS,S particles. The vaccine includes the AS01 adjuvant. The vaccine aims to induce antibodies to prevent liver infection and has been used in two groups: children aged 5–17 months and infants aged 6–12 weeks. In 2013 results emerged from 18 months of follow-up of the phase III study to show 46% efficacy in the first group and 27% in the second group. In 2016, final results indicated some protection in the former group with four doses of vaccine but no protection in the latter group.

Despite the modest success of RTS,S there is a strong argument made that the most effective vaccine is likely to target many antigens at different stages of the life-cycle of the parasite. For example, it has been noted that CD8⁺ T-cells can provide sterile protection against liver-stage malaria parasites in mice. However, the number of antigen-specific

CD8⁺ T-cells is very high, suggesting that reliance on this mechanism alone might be unwise. Encouraging data have emerged on combining immune responses to liver and blood stages of the parasite, particularly using viral vectors that can induce both effective antibody and T-cell responses. In addition, data in humans and mice suggest that antibodies blocking transmission can be beneficial.

One of the most promising opportunities for malaria vaccine research relates to definition of the complete malaria genome that should help identify more vaccine targets as described above for “reverse vaccinology.” Whole-organism-based malarial vaccines (e.g., irradiated sporozoites) are an alternative to recombinant vaccines that are being investigated.

Finally, it should be noted that, as with a number of viral infections, it is possible that T-cell-mediated immunity may contribute to malarial pathology. Infiltrating leukocytes have been observed in the brains of patients who have died of cerebral malaria and resistance to malarial disease has been correlated with a deficit in T-cell function in certain instances.

Table 12.4 Centers for Disease Control and Prevention (CDC) – recommended immunizations schedule for persons aged 0–18 years in the United States, 2014. The recommendations are to be read with many footnotes, which are presented on the CDC website (www.cdc.gov/vaccines/schedules/hcp/imz/child-adolescent.html).

Vaccine	Birth	1 mo	2 mos	4 mos	6 mos	9 mos	12 mos	15 mos	18 mos	19–23 mos	2–3 yrs	4–6 yrs	7–10 yrs	11–12 yrs	13–15 yrs	16–18 yrs
Hepatitis B (HepB)	1 st dose	↓.....2 nd dose.....↓					↓.....3 rd dose.....↓									
Rotavirus (RV) RV1 (2-dose series); RV5 (3-dose series)			1 st dose	2 nd dose												
Diphtheria, tetanus, & acellular pertussis (DTaP: < 7yrs)			1 st dose	2 nd dose	3 rd dose			↓.....4 th dose.....↓				5 th dose				
Tetanus, diphtheria, & acellular pertussis (Tdap: ≥ 7 yrs)														(Tdap)		
<i>Haemophilus influenzae</i> type b (Hib)			1 st dose	2 nd dose			↓...3 rd or 4 th dose...↓									
Pneumococcal conjugate (PCV13)			1 st dose	2 nd dose	3 rd dose		↓...3 rd or 4 th dose...↓									
Pneumococcal polysaccharide (PPSV23)																
Inactivated poliovirus (IPV) (<18 yrs)			1 st dose	2 nd dose			↓.....3 rd dose.....↓					4 th dose				
Influenza (IIV; LAIV) 2 doses for some							Annual vaccination (IIV only)					Annual vaccination (IIV or LAIV)				
Measles, mumps, rubella (MMR)							↓.....1 st dose.....↓					2 nd dose				
Varicella (VAR)							↓.....1 st dose.....↓					2 nd dose				
Hepatitis A (HepA)							↓.....2-dose series.....↓									
Human papillomavirus (HPV2: females only; HPV4; males and females)																
Meningococcal (Hib-Men-CY ≥ 6 weeks; MenACWY-D ≥ 9 mos; MenACWY-CRM ≥ 2 mos)																Booster

Range of recommended ages for all children
 Range of recommended ages for catch-up immunization
 Range of recommended ages for certain high-risk groups
 Range of recommended ages for certain high-risk groups
 Range of recommended ages during which catch-up is encouraged and for certain high-risk groups
 Not routinely recommended

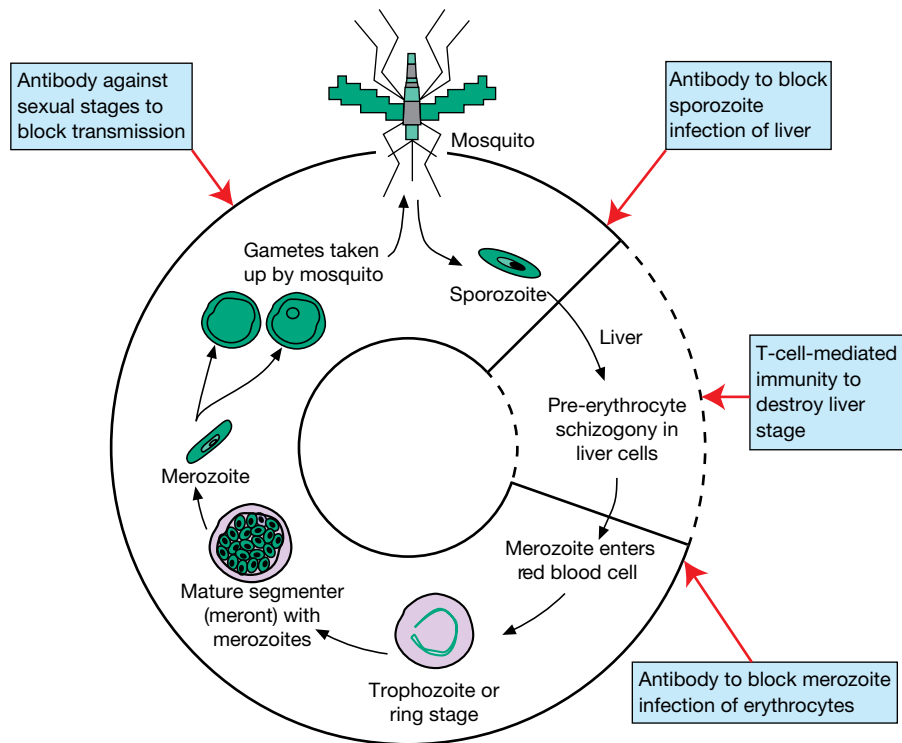


Figure 12.14 Vaccine targeting of the malaria life cycle. Some of the most investigated potential stages of the cycle to be targeted by vaccine strategies are illustrated.

Vaccines for protection against bioterrorism

Biological warfare has a long and dark history. One early example occurred in 1346 when a group of Tartars catapulted plague-infected bodies and heads over the city walls of the Black Sea town of Kaffa in an attempt to recapture the town from the Genovese. In 1763, the British were fighting native Americans and, as a supposed gesture of “goodwill,” donated smallpox-infected blankets resulting in many deaths in the native tribes. Throughout the last century many countries throughout the world had biological weapons programs. Particularly alarming for citizens of the United States were the anthrax cases that occurred in late 2001 following exposure to mail items deliberately contaminated with anthrax spores and sent to news media offices in New York City and Boca Raton, Florida, and to two US Senators in Washington, DC.

Aside from the anthrax (*Bacillus anthracis*), smallpox (variola), and plague (*Yersinia pestis*) mentioned above, many other infectious agents can potentially be used for bioterrorism, including *Clostridium botulinum* toxin (botulism), *Francisella tularensis* (tularemia), and the Ebola, Marburg,

Lassa, and South American hemorrhagic fever viruses. Efforts are under way, therefore, to develop vaccines against these diseases in those cases in which effective vaccines are not currently available. Considerable success has been noted at the Vaccine Research Center of the National Institutes of Health in Bethesda, Maryland, USA in developing a vaccine that protects monkeys against lethal challenge with Ebola virus. The vaccine uses non-replicating adenovirus as a vector for the introduction of Ebola virus genes and expression of Ebola virus proteins in the animals prior to exposure to virus. Following the eradication of smallpox, routine vaccination against smallpox was discontinued. Concern that this agent could be used as a biological weapon has led to calls for the reintroduction of routine vaccination against smallpox. Currently only a small number of laboratory researchers, key healthcare workers, and military personnel are vaccinated because it is felt that routine vaccination of the entire population would inevitably lead to a small number of vaccine-related deaths, a scenario accepted when a disease is endemic but not for a currently “extinct” disease. However, the vaccine is being stockpiled just in case. Incidentally, vaccination against smallpox would also protect against the related monkeypox virus.

Immunization against cancer

The realization that several different types of human cancer are closely associated with infectious agents suggests that vaccination against agents such as human papillomaviruses (cervical cancer), Epstein–Barr virus (Burkitt’s and other lymphomas, nasopharyngeal carcinoma), *Helicobacter pylori* (stomach cancer), hepatitis B virus (liver cancer), HTLV-1 (adult T-cell leukemia), and human herpesvirus 8 (Kaposi’s sarcoma) should lead to a substantial reduction in the incidence of such tumors. Cancer vaccines have also been developed against a number of tumor-associated antigens, including carcinoembryonic antigen (colorectal cancer), immunoglobulin idiotypes (B-cell lymphoma), MAGE (melanoma), and so on. Results to date have been somewhat less than spectacular using tumor-associated self antigens but there is hope that strategies such as targeted activation of dendritic cells will lead to improved response rates.

Other applications for vaccines

A vaccine based on the human chorionic gonadotropin hormone, which is made by the preimplantation blastocyst and is essential for the establishment of early pregnancy, has undergone clinical trials as an immunological contraceptive. Vaccines are also being developed for the treatment of allergies and autoimmune diseases. These are generally aimed at resetting the Th1/Th2 balance, activating regulatory T-cells, or re-establishing tolerance by clonal deletion or anergy. Vaccines are also being developed against agents of addiction, including tobacco and cocaine.



Adjuvants

For practical and economic reasons, prophylactic immunization should involve the minimum number of injections and the least amount of antigen. We have referred to the undoubted advantages of replicating attenuated organisms in this respect, but nonliving organisms, and especially purified products, frequently require an adjuvant that, by definition, is a substance incorporated into or injected simultaneously with antigen that potentiates the immune response (Latin *adjuvare* – to help).

Two types of action have been described for adjuvants: **immunostimulation** and **antigen delivery**. Immunostimulation results from the action of molecules to directly enhance immune responses. Immunostimulants include Toll-like receptor (TLR) agonists, cytokines, and bacterial exotoxins. The explosion of understanding in innate immunity in the last decade has greatly increased the potential for the rational design of immunostimulants. The

activation of dendritic cells is particularly important here as this leads to increased antigen uptake, migration to lymph nodes, and priming of CD4⁺ T-cell help for B- and T-cell responses. Antigen delivery vehicles serve to optimally present antigens to the immune system by, at least in part, preventing dispersal of antigen and promoting slow release of antigen (“depot effects”). Such vehicles can deliver not only antigen but also immunostimulants more effectively. Examples include mineral salts such as alum, emulsions such as Freund’s adjuvant, liposomes and immune-stimulating complexes (ISCOMs). In reality, many adjuvants combine to varying degrees the properties of immunostimulation and antigen delivery.

As stated above, conventional live attenuated vaccines typically do not require adjuvants, although responses sometimes can be enhanced by adjuvantation (e.g., hepatitis A vaccination). However, the immunogenicity of proteins is typically relatively poor and the use of adjuvants is required. This is particularly the case if the protein is presented as a soluble monomeric form, such as HIV gp120, rather than in a multimeric repeating particulate form, such as HBV surface antigen. The most widely used adjuvants in humans are based on gels formed by aluminum salts and are referred to collectively as “**alum**” adjuvants. Antigens are adsorbed on the aluminum particles and the appropriate adjuvant formulation selected based on immunogenicity. The activity of alum is ascribed to depot effects and immunostimulatory effects based on particle formation and induction of inflammation. Alum is used in several licensed vaccines, including hepatitis A, human papillomavirus (HPV), diphtheria–pertussis–tetanus (DPT), *Haemophilus influenzae* b, and inactivated polio.

Emulsions have been much used in vaccine research and are beginning to appear in human use. The classical adjuvant is Freund’s, which is a water-in-oil emulsion. The complete form consists of a water-in-paraffin-oil emulsion plus inactivated mycobacteria; the incomplete form lacks the mycobacteria. The lifelong persistence of oil in the tissues and the occasional production of sterile abscesses mean this adjuvant (incomplete form, the complete form is even less suitable) is not used in human vaccines. The montanides are similar to incomplete Freund’s but are biodegradable and have been used in HIV, malaria, and cancer vaccine trials. Ribi, a commonly used formulation in experimental work, is a water-in-oil emulsion incorporating monophosphoryl lipid A (MPL) and mycobacterial trehalose dimycolate (TDM). MLA is a derivative of one of the most potent stimulators of antigen-presenting cells, namely lipid A from Gram-negative bacterial lipopolysaccharide (LPS). Although lipid A has many side-effects, its derivative, MLA, is far less toxic. MF59 (Chiron – now Novartis) is an oil-in-water emulsion that has been safely used in millions of doses in an influenza vaccine in Europe. It effectively stimulates antibody and CD4⁺ T-cell

Table 12.5 Classes of clinically used and tested adjuvants.

Adjuvant name	Class	Mechanism or receptor	Type of immune response	Clinical phase or licensed product name
dsRNA analogues (for example, poly(I:C))	IM	TLR3	Ab, T _H 1, CD8 ⁺ T cells	Phase 1
Lipid A analogues (for example, MPL, RC529, GLA, E6020)	IM	TLR4	Ab, T _H 1	Cervarix, Supravax, Pollinex Quattro, Melacine
Flagellin	IM	TLR5	Ab, T _H 1, T _H 2	Phase 1
Imidazoquinolines (for example, Imiquimod, R848)	IM	TLR7 and TLR8	Ab, T _H 1	Aldara
CpG ODN	IM	TLR9	Ab, T _H 1, CD8 ⁺ T cells	Phase 3
Saponins (for example, QS21)	IM	Unknown	Ab, T _H 1, T _H 2, CD8 ⁺ T cells	Phase 3
C-type lectin ligands (for example, TDB)	IM	Mincle, Nalp3	Ab, T _H 1, T _H 17	Phase 1
CD1d ligands (for example, α -galactosylceramide)	IM	CD1d	Ab, T _H 1, T _H 2, CD8 ⁺ NKT cells	Phase 1
Aluminum salts (for example, aluminum oxyhydroxide, aluminum phosphate)	PF	Nalp3, ITAM, Ag delivery	Ab, T _H 2	Numerous licensed products
Emulsions (for example, MF59, AS03, AF03, SE)	PF	Immune cell recruitment, ASC, Ag uptake	Ab, T _H 1, T _H 2	Fluad, Pandemrix
Virosomes	PF	Ag delivery	Ab, T _H 1, T _H 2	Epaxal, Inflaxal V
AS01 (MPL, QS21, liposomes)	C	TLR4	Ab, T _H 1, CD8 ⁺ T cells	Phase 3
AS02 (MPL, QS21, emulsion)	C	TLR4	Ab, T _H 1	Phase 3
AS04 (MPL, aluminum salt)	C	TLR4	Ab, T _H 1	Cervarix
AS15 (MPL, QS21, CpG, liposomes)	C	TLR4 and TLR9	Ab, T _H 1, CD8 ⁺ T cells	Phase 3
GLA-SE (GLA, emulsion)	C	TLR4	Ab, T _H 1	Phase 1
IC31 (CpG, cationic peptide)	C	TLR9	Ab, T _H 1, T _H 2, CD8 ⁺ T cells	Phase 1
CAF01 (TDB, cationic liposomes)	C	Mincle, Ag delivery	Ab, T _H 1, CD8 ⁺ T cells	Phase 1
ISCOMs (saponin, phospholipid)	C	Unknowns	Ab, T _H 1, T _H 2, CD8 ⁺ T cells	Phase 2

Ab, antibody; Ag, antigen; ASC, apoptosis-associated speck-like protein containing caspase recruitment domain; C, combination of immunomodulatory molecule and particulate formulation; dsRNA, double-stranded RNA; IM, immunomodulatory molecule; ITAM, immunoreceptor tyrosine-based activation motif; PF, particulate formulation; TDB, trehalose dibehenate. Some particulate formulations (such as aluminum salts and emulsions) also generate immunomodulatory activity.

Source: Reed S.G. *et al.* (2013) *Nature Medicine* **19**, 1597–1608. Reproduced with permission of Nature Publishing Group.

responses but not CD8⁺ T-cell responses in humans and nonhuman primates. AS02 (GlaxoSmithKline) is an oil-in-water emulsion to which two immunostimulants, 3D-MPL and QS21, have been added. 3D-MPL is a derivative of MPL

and QS21 is a saponin, originally derived from tree bark, which stimulates both antibody and cell-mediated immunity. AS02 is seen as a potentially powerful adjuvant for vaccines in which antibody and T-cell-mediated immunity may be important,

such as HIV, or in which T-cell-mediated immunity is likely to be key, such as TB.

Particulate antigens elicit much better immune responses than soluble proteins. ISCOMs take advantage of this by trapping antigens in cage-like structures with saponins. ISCOMATRIX (CSL) refines this basic concept. Synthetic oligonucleotides (deoxyribonucleotides) containing unmethylated CpG motifs (CpG ODN) are powerful immunostimulants acting through interaction with TLR9. Different families of CpG ODN can preferentially stimulate different cells – B-cells, NK cells, dendritic cells, CD8⁺ T-cells – involved in immune responses. Liposomes, virosomes, and virus-like particles have the ability to present antigens in a multimeric form and can stimulate enhanced immune responses.

A number of pathogens gain entry to the body via mucosal surfaces and the induction of immune responses at these surfaces can be crucial in providing the best protection against disease. Many of the adjuvants described above can be used as mucosal adjuvants. However, there are also a number of molecules that are particularly effective as mucosal adjuvants, most notably cholera toxin (CT) and *E. coli* heat-labile enterotoxin (LT). Modified forms of the toxins and their subunits can powerfully stimulate mucosal responses through mechanisms that are not well understood.

Table 12.5 summarizes some of the adjuvants that have been used and are under development for use in human vaccines.

Passively acquired immunity

- Temporary protection against infection or clearance of toxins can be achieved with passively administered antibody preparations. Antisera from hyperimmunized animals and from immune humans are classically used in passive protection but increasingly human monoclonal antibodies are becoming available.
- Maternal antibody provides crucial protection to the newborn as its immune system matures.

Principles of vaccination

- Vaccines are effective because of humoral and cellular immune memory. Probably antibodies induced by vaccination are crucial in protecting against most bacteria and many viruses and parasites.
- Herd immunity is important in reducing disease incidence when transmission occurs between humans.

Killed organisms as vaccines

- Killed bacteria and viruses have been widely used as effective vaccines.

Live attenuated organisms

- The advantages include the larger antigen dose typically provided by a replicating organism, the tendency to elicit better cellular immunity and the generation of an immune response at the site of the natural infection.
- Nonpathogenic vectors such as adenovirus, attenuated fowlpox, and modified vaccinia Ankara virus can serve as Trojan horses for genes from pathogenic organisms that are difficult to attenuate.
- BCG is a good vehicle for antigens requiring CD4 T-cell immunity and salmonella constructs may give oral and systemic immunity. Intranasal immunization is gaining popularity.

- The risk with live attenuated organisms is reversion to the virulent form and danger to immunocompromised individuals.

Subunit vaccines

- Whole organisms have a multiplicity of antigens, some of which are not protective, may induce hypersensitivity or might even be immunosuppressive.
- It makes particular sense in these cases to use purified components or those made recombinantly.
- Toxoids (inactivated toxins) are effective as vaccines in preventing illness due to some bacterial agents.
- The hepatitis B surface antigen particle is a classic example of an effective subunit viral vaccine.
- Many successful bacterial vaccines target glycans on the surface of the organism using glycoconjugate preparations.
- DNA encoding the proteins from a pathogen can be injected directly into muscle to generate the proteins *in situ* and produce immune responses. The advantages are stability, ease of production, and cheapness. The method has not been as effective in humans as in mice but newer developments such as a DNA prime with a protein or vector boost are promising. Perhaps even more promising is the development of RNA vaccines, particularly using self-replicating vectors.

Newer approaches to vaccines

- The rise of genomics has been crucial in allowing a rational approach to the identification of many more bacterial vaccine targets. “Reverse vaccinology” has been successfully applied to the development of a MenB vaccine.

- Highly variable pathogens such as HIV and HCV present particular problems to vaccine design in that they require the elicitation of broadly protective immune responses. Here molecular approaches are being adopted to describe how broadly neutralizing antibodies interact with their targets and use the information to rationally design vaccine candidates.

Current vaccines

- Children in both the United States and United Kingdom are routinely immunized with diphtheria and tetanus toxoids and acellular pertussis (DTP triple vaccine), attenuated strains of measles, mumps, and rubella (MMR), inactivated polio, and the capsular polysaccharide of *H. influenzae* type b (Hib) linked to a carrier.
- Vaccines against anthrax, Japanese encephalitis virus, hepatitis A, yellow fever, cholera, and rabies, among others, are not given routinely but are available for travelers and high-risk groups.

Vaccines in development

- A vaccine to malaria has been reported to show moderate success. Many argue that a successful vaccine should target multiple antigens and multiple stages of the malarial life cycle.

- Most vaccines to HIV that have been investigated to date in humans have failed with one possible partial success. Efforts are focused on a number of fronts to generate usable vaccines.
- Vaccines are being developed for many pathogens, including *Clostridium difficile*, dengue virus, herpes simplex virus, and West Nile virus.

Adjuvants

- Adjuvants generate enhanced longer lived immune responses. They are generally not required for live attenuated vaccines but are crucial for protein subunit vaccines.
- Adjuvants function by immunostimulation and antigen delivery or both.
- Immunostimulation arises by the action of molecules such as TLR agonists, cytokines, and bacterial exotoxins to directly enhance immune responses, particularly involving the dendritic cell. Antigen delivery vehicles prevent antigen dispersal and promote slow release. They include mineral salts and emulsions.
- Certain adjuvants such as cholera toxin are potent at stimulating mucosal responses, which may be most appropriate for certain pathogens infecting via mucosal surfaces.



Now visit www.roitt.com to test yourself on this chapter.

FURTHER READING

- Allen A. (2008) *Vaccine: the Controversial Story of Medicine's Greatest Life Saver*. W.W. Norton & Company, New York.
- Amanna I.J., Messaoudi I., and Slifka M.K. (2008) Protective immunity following vaccination: how is it defined? *Human Vaccines* **4**, 316–319.
- Amanna I.J. and Slifka M.K. (2009) Wanted, dead or alive: new viral vaccines. *Antiviral Research* **84**, 119–130.
- Astronomo R.D. and Burton D.R. (2010) Carbohydrate vaccines: developing sweet solutions to sticky situations? *Nature Reviews Drug Discovery* **9**, 308–324.
- Barrett A.D. and Beasley D.W. (2009) Development pathway for biodefense vaccines. *Vaccine* **27**, D2–D7.
- Burton D.R., Ahmed R., Barouch D.H., et al. (2012) A blueprint for HIV vaccine discovery. *Cell Host Microbe* **12**, 396–407.
- Casadevall A., Dadachova E., and Pirofski L.A. (2004) Passive antibody therapy for infectious diseases. *Nature Reviews Microbiology* **2**, 695–703.
- De Gregorio E., D'Oro U., Bertholet S., and Rappuoli R. (2013) Vaccines. In *Fundamental Immunology*, Vol. **43** (ed. Paul W.E.). Lippincott Williams and Wilkins, Philadelphia, pp. 1032–1068.
- Delany I., Rappuoli R., and De Gregorio E. (2014) Vaccines for the 21st century. *Embo Molecular Medicine* **6**, 708–720.
- Frazer I.H., Lowy D.R., and Schiller J.T. (2007) Prevention of cancer through immunization: prospects and challenges for the 21st century. *European Journal of Immunology* **37** (Suppl 1), S148–S155.
- Galson J.D., Pollard A.J., Trück J., and Kelly D.F. (2014) Studying the antibody repertoire after vaccination: practical applications. *Trends in Immunology* **35**, 319–331.
- Geall A.J., Mandl C.W., and Ulmer J.B. (2013) RNA: the revolution in nucleic acid vaccines. *Seminars in Immunology* **25**, 152–159.
- Henderson D.A. (2009) *Smallpox – the Death of a Disease: the Inside Story of Eradicating a Worldwide Killer*. Prometheus Books, New York.
- Kaufmann S.H. (2012) Tuberculosis vaccine development: strength lies in tenacity. *Trends in Immunology* **33**, 373–379.
- Kaufmann S.H., McElrath M.J., Lewis D.J., and Del Giudice G. (2014) Challenges and responses in human vaccine development. *Current Opinion in Immunology* **28**, 18–26.

- Li S., Nakaya H.I., Kazmin D.A., Oh J.Z., and Pulendran B. (2013) Systems biological approaches to measure and understand vaccine immunity in humans. *Seminars in Immunology* **25**, 209–218.
- Offit P.A. (2007) *Vaccinated: One Man's Quest to Defeat the World's Deadliest Diseases*. Smithsonian Books, New York.
- Oldstone M.B. (2009) *Viruses, Plagues, and History: Past, Present and Future*, 2nd edn. Oxford University Press, Oxford.
- Plotkin S.A. (2010) Correlates of protection induced by vaccination. *Clinical Vaccine and Immunology* **17**, 1055–1065.
- Reed S.G., Orr M.T., and Fox C.B. (2013) Key roles of adjuvants in modern vaccines. *Nature Medicine* **19**, 1597–1608.
- Reperant L.A., Rimmelzwaan G.F., and Osterhaus A.D. (2014) Advances in influenza vaccination. *F1000Prime Reports* **6**, 47.
- Stanisic D.I., Barry A.E., and Good M.F. (2013) Escaping the immune system: How the malaria parasite makes vaccine development a challenge. *Trends in Parasitology* **29**, 612–622.
- Taylor K., Nguyen A., and Stéphenne J. (2009) The need for new vaccines. *Vaccine* **27**, G3–G8.

CHAPTER 13

Immunodeficiency

Key topics

- Deficiencies of pattern recognition receptor signaling 379
- Phagocytic cell defects 379
- Primary immunodeficiency affecting other cells of the innate response 382
- Complement system deficiencies 382
- Cytokine and cytokine receptor deficiencies 384
- Primary B-cell deficiency 386
- Primary T-cell deficiency 387
- Severe combined immunodeficiency (SCID) 389
- Diagnosis of primary immunodeficiencies 390
- Treatment of primary immunodeficiencies 391
- Secondary immunodeficiency 391
- Acquired immunodeficiency syndrome (AIDS) 392



Just to recap ...

Multipotent hematopoietic stem cells in the bone marrow can develop down either the myeloid or lymphoid pathway to differentiate into the various cell types that mediate the immune response. Migration of immune system cells from the blood circulation into the tissues involves cell adhesion molecules, chemotactic factors, and complement components that regulate the inflammatory response. Upon entering the tissues, the phagocytic cells of the innate response engulf and subsequently destroy pathogens using a plethora of microbicidal agents. Natural killer (NK) cells are involved in dealing with intracellular infections, a situation in which the pathogen is shielded from the effects of phagocytes and complement. Providing back-up to these innate responses is the acquired immune response that involves the antibody-producing B-cells together with helper, cytotoxic, and regulatory T-cells. Although normally all the cells and molecules of the immune system interact effectively to fight infection there is always the possibility that one or more participants might fail, either owing to inherited gene defects or because of damage caused by external factors.

Introduction

In accord with the dictum that “most things that can go wrong, do so,” a multiplicity of immunodeficiency states in humans, which are *not secondary* to environmental factors, have been recognized. These “experiments of nature” provide valuable clues regarding the function of the defective factors concerned. We have earlier stressed the manner in which the interplay of complement, antibody and phagocytic cells constitutes the basis of a tripartite defense mechanism against pyogenic (pus-forming) infections with bacteria that require prior opsonization before phagocytosis. It is not surprising, then, that deficiency in any one of these factors may predispose the individual to repeated infections of this type. Patients with T-cell deficiency of course present a markedly different pattern of infection, being susceptible to those intracellular bacteria, viruses, and fungi that are normally eradicated by cell-mediated immunity (CMI).

The following sections deal first with some examples of these relatively uncommon genetically determined *primary immunodeficiency diseases (PIDs)*. The severity of such diseases can vary depending upon the particular mutation in a given gene. Thus some patients may, for example, have a mutation that results in the complete absence of the gene product whereas others may possess a mutation that leads only to a slight misfolding of the protein resulting in a relatively minor impairment of function. We will then examine the various environmental factors, such as infection and malnutrition, that can be responsible for the much more prevalent *secondary immunodeficiencies*. We then consider in detail HIV/AIDS in terms of the natural history of HIV infection, the life-cycle of the virus, therapy, and vaccines.

Deficiencies of pattern recognition receptor signaling

Recognition of pathogen-associated molecular patterns (PAMPs) by dendritic cells and other cells of the innate response is fundamental to the detection of microorganisms. Several gene defects have been described that result in impaired signaling through pattern recognition receptors (PRRs). The MyD88 adaptor protein is required for signaling through a number of Toll-like receptors (TLRs), and patients with MyD88 deficiency suffer from severe life-threatening infections with pyogenic bacteria, including pneumococci and *Salmonella*. The IL1R-associated kinase-4 (IRAK4) is involved in signaling through the IL-1 and IL-18 receptors and also through the TLR1/2 heterodimer, TLR2/6 heterodimer, TLR7, and TLR8. In IRAK4-deficient individuals it is Gram-positive pyogenic bacteria, including *Streptococcus pneumoniae* and *Staphylococcus aureus*, that are most commonly seen. In response to engagement by their ligands, the intracellular TLRs (TLR3, -7, -8, and -9) interact with the ER-resident accessory molecule UNC93B1. Deficiencies in this protein are associated particularly with herpes simplex virus encephalitis, as is mutation in TLR3 or in the signaling molecules TRAF and TRIF.

Phagocytic cell defects (Table 13.1)

In *chronic granulomatous disease* the monocytes, macrophages, and neutrophils fail to produce reactive oxygen intermediates because of a defect in the nicotinamide adenine dinucleotide phosphate (NADPH) oxidase system (see Chapter 1) normally activated by phagocytosis. The cytochrome b_{558} component of this system is composed of 91 and 22 kDa *phox* (phagocyte oxidase) subunits and, in the X-linked form of the disease, there are mutations in the gene encoding the larger of these subunits (Figure 13.1). In the majority of cases, no cytochrome is produced, but one variant gp91 mutation permits the synthesis of low levels of the protein (Figure 13.2) and the condition can be improved by treatment with interferon- γ (IFN γ). Not unexpectedly, the knockout of gp91^{phox} provides a handy mouse model. The 30% of chronic granulomatous disease patients who inherit their disorder in an autosomal recessive pattern express a defective form of the oxidase resulting from mutations in the smaller p22^{phox} cytochrome subunit or in the cytosolic p40^{phox}, p47^{phox}, or p67^{phox} molecules (Figure 13.1).

Curiously, the range of infectious pathogens that trouble these patients is relatively restricted. The most common pathogen is *Staphylococcus aureus*, but certain Gram-negative bacilli and also fungi such as *Candida albicans* and *Aspergillus fumigatus* are frequently involved (Figure 13.3). The factors underlying this restriction are two-fold. First, many bacteria help to bring about their own destruction by generating H₂O₂ through their own metabolic processes, but if they are catalase positive, the

Table 13.1 Some deficiencies of phagocytic cells.

Defective gene	Disorder	Typical infections
<i>CD18 β-subunit</i>	Leukocyte adhesion deficiency 1	Pyogenic bacteria
<i>MVK</i>	Hyper-IgD syndrome (HIDS)	None
<i>NLRP3, IL1RN</i>	Cryopyrin-associated periodic syndrome	None
<i>SLC35C1</i>	Leukocyte adhesion deficiency 2	Pyogenic bacteria
<i>FERMT3</i>	Leukocyte adhesion deficiency 3	Pyogenic bacteria
<i>IFNγR1, IFNγR2, IL-12 p40, IL-12R/IL-23R shared β1 subunit, STAT1, IRF8, GATA2, IGS15</i>	Mendelian susceptibility to mycobacterial disease	Mycobacteria, <i>Salmonella</i> , viruses
<i>LYST</i>	Chédiak–Higashi	<i>Staph. aureus</i> , <i>Strep. pyogenes</i> , pneumococci, <i>Aspergillus</i> spp., <i>Pseudomonas aeruginosa</i>
<i>MEVF</i>	Familial Mediterranean fever	None
<i>p22phox, p40phox, p47phox, p67phox, or gp91phox</i>	Chronic granulomatous disease	<i>Staph. aureus</i> , <i>Aspergillus fumigatus</i> , <i>Candida albicans</i>
<i>TNFRSF1A</i>	TNF receptor-associated periodic syndrome (TRAPS)	None

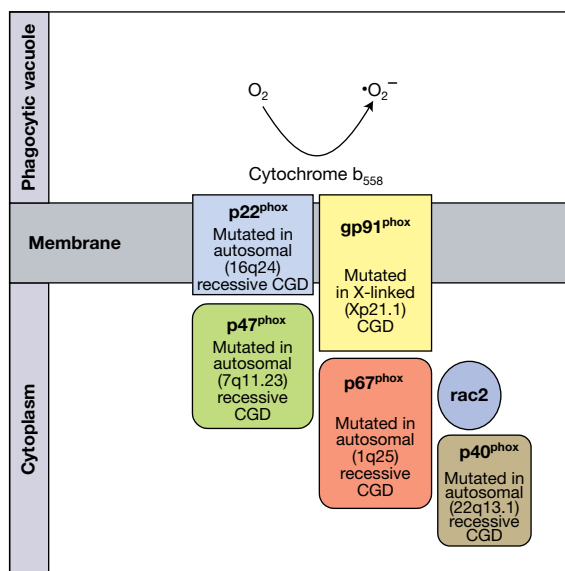


Figure 13.1 Mutations in NADPH oxidase components responsible for chronic granulomatous disease (CGD). The cytochrome b_{558} found in the phagocyte membrane is composed of $p22^{phox}$ and $p91^{phox}$. Upon cell activation the cytosolic proteins $p47^{phox}$, $p67^{phox}$, and $p40^{phox}$, together with the small GTP-binding protein $rac2$, associate with cytochrome b_{558} to form the active NADPH oxidase complex, resulting in the generation of the superoxide anion (see Figure 1.29). Most patients with CGD have the X-linked form of the disease involving mutations in the $gp91^{phox}$ gene. Mutations in the genes encoding other components of the NADPH oxidase are responsible for the autosomal forms of the disease.

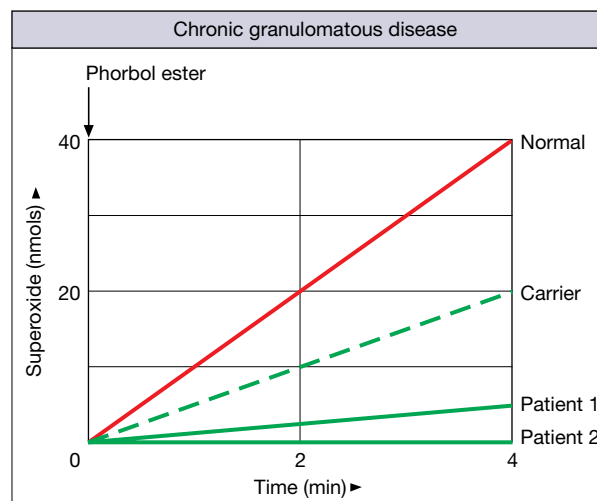


Figure 13.2 Defective respiratory burst in neutrophils of patients with chronic granulomatous disease. The activation of the NADPH oxidase is measured by superoxide anion ($\cdot O_2^-$; see Figure 1.29) production following stimulation with phorbol myristate acetate. Patient 2 has a $p91^{phox}$ mutation that prevents expression of the protein, whilst patient 1 has a different $p91^{phox}$ mutation that results in very low but measurable levels. Many carriers of the X-linked disease express intermediate levels, as in the individual shown who is the mother of patient 2. (Data source: Smith R.M. and Curnutte J.T. (1991) *Blood* **77**, 673.)



Figure 13.3 Fulminant pneumonitis in a patient with chronic granulomatous disease (CGD). Chest radiograph of a 15-year-old boy with autosomal recessive CGD, showing bilateral dense infiltrates because of *Aspergillus fumigatus* and *Absidia corymbifera* pneumonitis. (Source: Slatter M.A. and Gennery A.R. (2008) *Clinical Experimental Immunology* **152**, 389–396. Reproduced with permission of Wiley.)

peroxide is destroyed and the bacteria will survive. Thus neutrophils from these patients readily take up catalase-positive staphylococci in the presence of antibody and complement but fail to kill them intracellularly. Second, the most virulent organisms tend to be those that are highly resistant to the oxygen-independent microbicidal mechanisms of the phagocyte.

Lack of the CD18 β subunit of the β_2 -integrins produces **leukocyte adhesion deficiency (LAD)** type I, causing impaired neutrophil chemotaxis and recurrent bacterial infection. Emigration of monocytes, eosinophils, and lymphocytes is unaffected as these can fall back on the alternative VCAM-1/VLA-4 β_1 -integrin system. In contrast, LAD type II is due to a defective GDP-fucose transporter encoded by the *SLC35C1* gene resulting in an inability to fucosylate sialyl-Lewis^x structures which mediate leukocyte adhesion, whereas mutation of the *FERMT3* gene encoding the integrin-activation molecule kindling-3 is responsible for LAD type III.

In **Chédiak–Higashi** disease and the “beige” murine counterpart, dysfunction of neutrophils, NK cells and cytotoxic T-cells is associated with defects in the *LYST* (lysosomal trafficking) gene. Accumulation of giant intracytoplasmic granules occurs because of defective migration of the late endosomal/lysosomal compartment within the cell. Patients suffer from sometimes fatal pyogenic infections, particularly with *Staphylococcus aureus*. Most develop an “accelerated phase” of the disease in which there is unremitting T-cell proliferation; this can potentially be brought under control by hematopoietic stem cell transplantation.

Mendelian susceptibility to mycobacterial disease (MSMD) in humans involving bacille Calmette–Guérin (BCG) or nontuberculous mycobacteria can be traced to mutations in several genes, including those encoding either chains of the IFN γ receptor (IFN γ R1 and IFN γ R2), the IL-12 p40 subunit, the IL-12R/IL-23R shared β 1 subunit, the signal transducer and activator of transcription-1 (STAT1) molecule, interferon regulatory factor 8 (IRF8), GATA2, and IGS15 (interferon-stimulated gene 15). As well as being particularly prone to mycobacterial infections, patients with MSMD show increased susceptibility to other intracellular bacteria, particularly *Salmonella*, and to viruses. Because IL-12 drives the differentiation of the IFN γ -producing Th1 subset, collectively the genes involved in MSMD very nicely underline the role of IFN γ in mediating protection against intracellular infection.

Autoinflammatory disorders

There are over 30 so-called **autoinflammatory disorders**. Some are caused by a single-gene defect (monogenic); others are polygenic in nature. They are included here because they represent deficiency of immune response related genes that by various mechanisms affect the activity of neutrophils, monocytes and macrophages. Characteristically, there are episodes of apparently unprovoked inflammation, fever, rashes, joint and muscle aches, and abdominal or chest pain. The common theme is dysregulated expression or control of proinflammatory cytokines such as IL-1 β . Thus, one of these disorders, **familial Mediterranean fever**, is caused by mutations in the *MEFV* gene that encodes pyrin, an inflammasome regulator expressed predominantly in neutrophils and activated monocytes. Inflammasomes generate active caspase-1 which converts pro-IL-1 β into the active form of the cytokine. The pattern of inheritance can be autosomal recessive (i.e., both copies of the gene need to be defective) or autosomal dominant (only one copy of the gene needs to be defective), depending upon the severity of the particular mutation involved. The **cryopyrin-associated periodic syndrome (CAPS)** is associated with autosomal dominant mutations in the *NLRP3* gene, whereas the condition known as **deficiency of the interleukin-1 receptor antagonist (DIRA)** involves an autosomal recessive mutation in the *IL1RN* gene encoding the IL-1 receptor antagonist (IL-1RA), resulting in uncontrolled activity of IL-1 β (Figure 13.4).

Another important proinflammatory cytokine is, of course, tumor necrosis factor (TNF), and the **TNF receptor-associated periodic syndrome (TRAPS)** is caused by dominantly inherited mutations in the *TNFRSF1A* gene encoding the p55 TNF receptor. Another hereditary periodic fever, **hyper-IgD syndrome (HIDS)**, also referred to as hyperimmunoglobulinaemia D with periodic fever syndrome, is caused by an autosomal recessive mutation in the mevalonate kinase (*MVK*) gene, indirectly leading to increased production of proinflammatory isoprenoids.

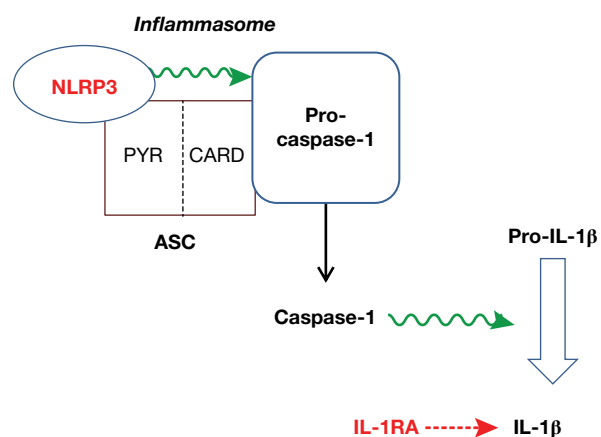


Figure 13.4 Autoinflammatory disorders involving IL-1 β . Inflammasomes of various composition result in the generation of caspase-1 which subsequently cleaves pro-IL-1 β to generate the inflammatory cytokine IL-1 β . Mutations in the genes encoding NLRP3 and IL-1RA (indicated in red) have been shown to be responsible for two of the autoinflammatory disorders. IL-1RA is the IL-1 receptor antagonist, mutations in which prevent the control of excess IL-1 β . ASC (apoptosis-associated speck-like protein containing a caspase-recruitment domain) is an adaptor protein that contains a pyrin-domain (PYR) to link to the NLRP3 sensor molecule, and a caspase activation and recruitment domain (CARD) to link to pro-caspase-1.

Primary immunodeficiency affecting other cells of the innate response

Natural killer (NK) cells play important roles in surveillance and subsequent destruction of infected cells and in the production of cytokines such as IFN γ . Mutation of the *MCM4* gene, which encodes a component of DNA helicase, results in an autosomal recessive disease in which there is a complete lack or very low numbers of NK cells, leaving patients susceptible to viral and mycobacterial infections. Defects in the *ADA* (adenosine deaminase), *JAK-3*, and *γc* genes are responsible for NK-SCID, which will be discussed a little later in this chapter. NK cell **activity** can be affected by mutations in a number of genes, including *DOCK8* and *MAGT1*. *DOCK8* is a guanine-nucleotide-exchange factor (GEF) involved in cell signaling and mutations in this gene not only affect NK cell function but in addition cause defects in B-cell activation and the survival of CD8⁺ T-cells. Patients are particularly prone to bacterial and viral skin and lung infections. The gene encoding the magnesium transporter protein-1 (*MAGT1*) is one of several immunodeficiency-associated genes that map to the X chromosome (Figure 13.5). Defects in *MAGT1* result in decreased expression of the NKG2D-activating receptor on NK cells and T-cells, and patients are particularly susceptible to infection with Epstein–Barr virus.

Autosomal dominant mutations in the gene encoding the GATA2 transcription factor impair the production of dendritic cells, monocytes, neutrophils, and NK cells in addition to T-cells, whereas mutations in the IRF8 transcription factor have a less profound effect, mainly interfering with the development of dendritic cells and monocytes and particularly conferring susceptibility to mycobacterial infections.

Mast cells do not escape the possibility of being affected by genetic mutations. Individuals who inherit defects in the *PLCG2* gene encoding phospholipase C γ 2 develop PLCG2-associated antibody deficiency and immune dysregulation (PLAID), one feature of which is cold urticaria in which patients' mast cells spontaneously degranulate in cold temperatures.

Complement system deficiencies (Table 13.2)

Defects in control proteins

The importance of complement in defense against infections is emphasized by the occurrence of repeated life-threatening infection with pyogenic bacteria in patients lacking factor I, the C3b inactivator. Because of this inability to destroy C3b, there is continual activation of the alternative pathway through the feedback loop, leading to very low C3 and factor B levels with normal C1, C4, and C2.

Erythrocytes are bombarded daily with C3b generated through the formation of fluid-phase alternative pathway C3 convertase from the spontaneous hydrolysis of the internal thiolester of C3. There are several regulatory components on the red blood cell surface to deal with this. The C3 convertase complex is dissociated by decay accelerating factor (DAF; CD55) and by CR1 complement receptors (not forgetting factor H from the fluid phase), after which the C3b is dismembered by factor I in concert with CR1, membrane cofactor protein (MCP) or factor H (Figure 13.6). There are also two inhibitors of the membrane attack complex, homologous restriction factor (HRF) and the abundant protectin molecule (CD59) that, by binding to C8, prevent the unfolding of the first C9 molecule needed for membrane insertion. DAF, HRF, and protectin bind to the membrane through glycosyl phosphatidylinositol anchors. In a condition known as *paroxysmal nocturnal hemoglobinuria (PNH)*, there is a defect in the ability to synthesize these anchors, caused by a mutation in the X-linked *PIG-A* gene that encodes the enzyme required for adding *N*-acetylglucosamine to phosphatidylinositol. In the absence of these complement regulators, lysis of the red blood cells occurs. The phenotype in which there are normal levels of these protective molecules is referred to as "type I." In the type II PNH disease phenotype, there is a defect in DAF, whereas in the more severe type III form protectin and HRF are also affected and susceptibility to spontaneous complement-mediated lysis is

	Location	Gene	PID	
p	22.3			
	22.2			
	22.1	p22.1	<i>PIG-A</i>	Paroxysmal nocturnal hemoglobinuria
	21.3			
	21.2			
	21.1	p21.1	<i>gp91^{phox}</i>	Chronic granulomatous disease (CGD)
	11.4	p11.4-11.21	<i>WASP</i>	Wiskott–Aldrich syndrome (WAS)
	11.3			
	11.23	p11.23	<i>Foxp3</i>	Immune dysregulation, polyendocrinopathy, enteropathy, X-linked (IPEX)
	11.22			
11.21				
q	11.1			
	11.2			
	12			
	13.1	q13.1	γC	X-linked severe combined immunodeficiency (SCID)
	13.2			
	13.3			
	21.1	q21.1	<i>MAGT1</i>	NKG2D deficiency
	21.2			
	21.31			
	21.32			
	21.33	q21.33	<i>Btk</i>	X-linked agammaglobulinaemia (XLA)
	22.1			
	22.2			
	22.3			
	23			
	24			
	25	q25	<i>XIAP</i>	X-linked lymphoproliferative disease type 2 (XLP2)
	26.1	q25-26	<i>SH2D1A</i>	X-linked lymphoproliferative disease type 1 (XLP1)
26.2	q26	<i>CD40L</i>	X-linked hyper-IgM syndrome (XHIGM)	
26.3				
27.1				
27.2				
27.3				
28	q28	<i>NEMO</i>	X-linked hyper-IgM syndrome (XHIGM)	

Figure 13.5 Loci of the major X-linked immunodeficiency syndromes. Males are more likely to be affected by X-linked recessive genes because, unlike the situation with females when there are two X chromosomes, homozygosity is not needed. In some cases the precise location of the relevant gene is still to be ascertained. A number of other rare X-linked immunodeficiencies have also been described. Some of the primary immunodeficiency diseases (PIDs) listed (e.g., CGD, SCID, HIGM) can also be due to defective genes on other chromosomes.

greatly increased (Figure 13.6). A monoclonal antibody to complement component C5, eculizumab, is effective in treating PNH by preventing C5 convertase-mediated cleavage and thus the generation of the membrane attack complex.

Polymorphisms in the complement regulatory factors H and I, as well as in factor B, C2, and C3, are associated with the development of *age-related macular degeneration (AMD)*, the leading cause of visual impairment in the developed world

and third leading cause (after cataracts and glaucoma) globally. These associations appear to be related to the enhanced inflammatory responses seen in patients with AMD. Polymorphisms in genes linked to angiogenesis, lipid metabolism, and extracellular matrix remodeling have also been described in this condition.

A defective gene for the C1 inhibitor is associated with *hereditary angioedema* and can lead to recurring episodes of

Table 13.2 Some deficiencies of complement pathways.

Defective gene	Disorder	Typical infections
<i>C1q, C1r, C1s</i>	Predisposition to immune complex-mediated autoimmune disease such as systemic lupus erythematosus	Pyogenic bacteria
<i>C1 inhibitor</i>	Hereditary angioedema	Usually none
<i>C2, C3, factor I</i>	Predisposition to immune complex-mediated autoimmune disease such as systemic lupus erythematosus and to age-related macular degeneration	Pyogenic bacteria
<i>C5, C6, C7, C8, C9, factor D, properdin</i>	C5, C6, C7, C8, C9, factor D, and properdin deficiencies	<i>Neisseria gonorrhoeae</i> , <i>N. meningitidis</i>
<i>C2, C3, factor B, factor H, factor I</i>	Age-related macular degeneration	Pyogenic bacteria
<i>MASP-2</i>	MASP-2 deficiency	<i>Strep. pneumoniae</i>
<i>MBL</i>	MBL deficiency	None
<i>PIG-A</i>	Paroxysmal nocturnal hemoglobinuria	Usually none

acute circumscribed non-inflammatory edema mediated by a vasoactive C2 fragment (Figure 13.7). The patients synthesize small amounts of the inhibitor that can be raised to useful levels by administration of the synthetic anabolic steroid danazol or of the purified inhibitor itself. ϵ -Aminocaproic acid, which blocks the plasmin-induced liberation of the C2 kinin, provides an alternative treatment.

Deficiency in components of the complement pathways

Deficiencies in C1q, C1r, C1s, C2, C3, as well as in factor I, can all predispose to the development of immune-complex-mediated autoimmune diseases such as systemic lupus erythematosus (SLE), mostly because of a decreased ability to eliminate immune complexes and apoptotic material effectively. Bearing in mind the focus of the autoimmune response in SLE on the molecular constituents of the blebs appearing on the surface of apoptotic cells, the importance of C1q in binding to and clearing these apoptotic bodies becomes paramount. So it is that C1q-deficient mice develop high-titer antinuclear antibodies and die with severe glomerulonephritis. Deficiency of any of the early complement components is also associated with recurrent infections with pyogenic bacteria, particularly so with C3 deficiency which will of course affect all three pathways of complement activation.

Patients who are deficient in components of the membrane attack complex (i.e., C5, C6, C7, C8, or C9) exhibit increased susceptibility to disseminated *Neisseria gonorrhoeae* and *N. meningitidis*. Such infections are also characteristic of deficiencies in the alternative pathway components factor D and properdin. Interestingly, the inability to produce a membrane attack

complex does not have a substantial effect on the incidence of other types of infection. Adequate protection must be largely afforded by opsonization of microorganisms with antibody and/or the C3b, C4b, and iC3b complement components for subsequent phagocytosis, and the immune adherence mechanism whereby organisms coated with these early complement components become bound to the CR1 complement receptor on erythrocytes and are then taken to the liver or spleen for destruction.

Mutations that lead to reduced levels of mannose-binding lectin (MBL) are fairly common but this does not result in a detectable increase in infections in most cases. Presumably complement activation by other mammalian lectins such as ficolin, or indeed by the antibody-mediated classical pathway, compensates for the absence of the MBL-mediated pathway. However, other individuals with an MBL-associated serine protease-2 (MASP-2) deficiency due to a mutation that renders the enzyme nonfunctional exhibit increased pyogenic infections by organisms such as *Streptococcus pneumoniae*.

Cytokine and cytokine receptor deficiencies

Given their fundamental role in the coordination of the immune response it is glaringly obvious that genetically determined defects in cytokines might have adverse consequences. Patients with WHIM syndrome (warts, hypogammaglobulinemia, infections, and myelokathesis) have mutations in the gene encoding the CXCR4 chemokine receptor. Autosomal recessive mutations in the genes encoding IL-10 and in the IL-10R1 and IL-10R2 chains of the

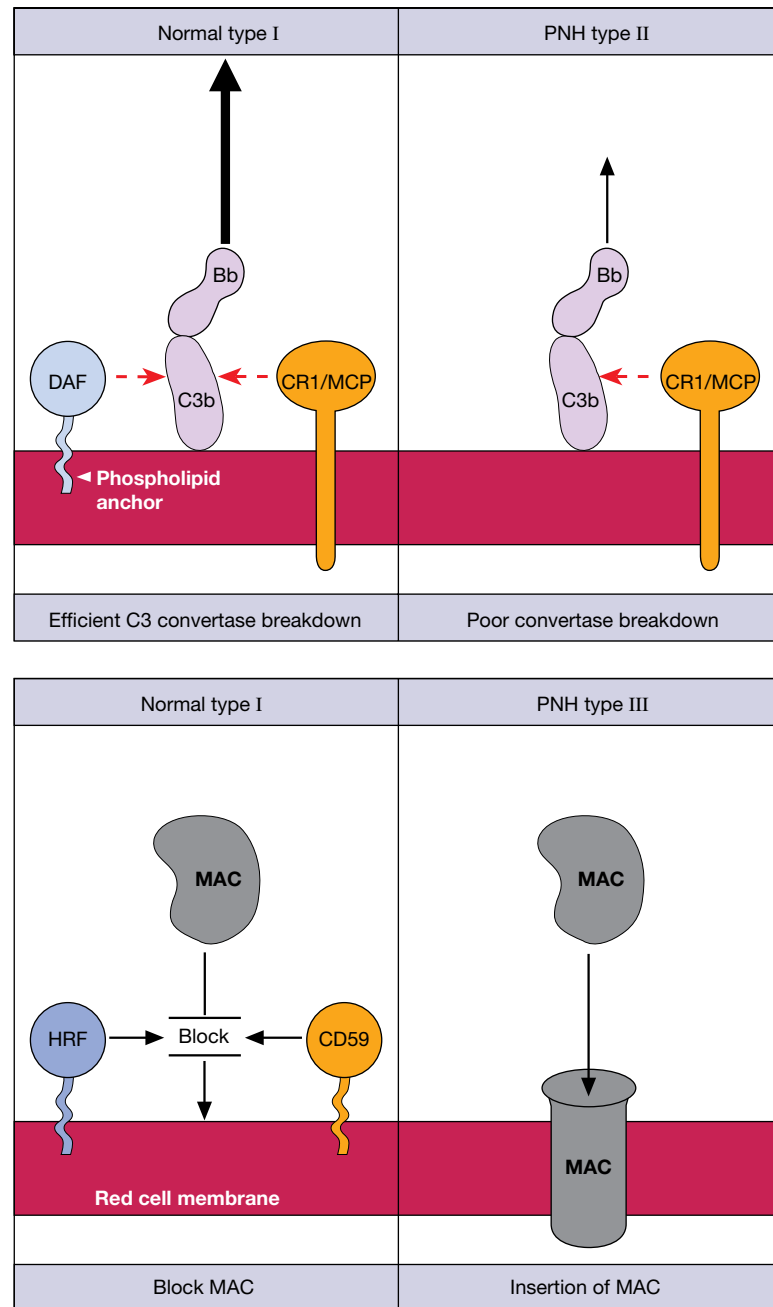


Figure 13.6 Paroxysmal nocturnal hemoglobinuria (PNH). A mutation in the *PIG-A* gene, which encodes α -1,6-*N*-acetylglucosaminyl-transferase, results in an inability to synthesize the glycosyl phosphatidylinositol anchors, deprives the red blood cell membrane of complement control proteins and renders the cell susceptible to complement-mediated lysis. PNH type II is associated with a DAF defect and the more severe type III with additional CD59 (protectin) and HRF deficiency. DAF, decay accelerating factor; CR1, complement receptor type 1; MCP, membrane cofactor protein; HRF, homologous restriction factor; MAC, membrane attack complex.

IL-10 receptor lead to defective regulation of myeloid cells and the development of inflammatory bowel disease, with susceptibility to cryptosporidia a further consequence. Increased infection with this protozoan is also seen in patients with mutations in the gene encoding the IL-21

receptor. Two more examples of defects in cytokine pathways are autosomal recessive mutations in *IL-17RA* and autosomal dominant mutations in *IL-17F*, both resulting in increased susceptibility to bacterial infections and to candidiasis.

Primary B-cell deficiency (Table 13.3)

A number of gene defects can result in a block at a particular stage in the development of lymphoid cells (Figure 13.8)

Agammaglobulinemia due to early B-cell maturation failure

In *X-linked agammaglobulinemia (XLA)* the defect occurs at the pre-B-cell stage and the production of immunoglobulin in affected males is grossly depressed, there being few lymphoid follicles or plasma cells in the lymph nodes. Mutations occur in

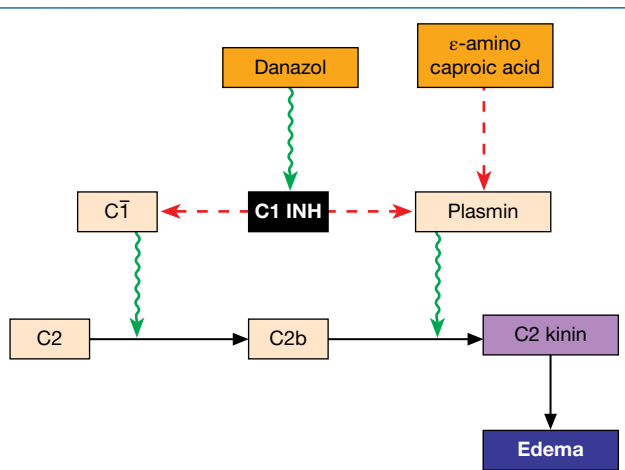


Figure 13.7 C1 inhibitor deficiency and angioedema. C1 inhibitor stoichiometrically inhibits C1, plasmin, kallikrein, and activated Hageman factor and deficiency leads to formation of the vasoactive C2 kinin by the mechanism shown. The synthesis of C1 inhibitor can be boosted by the synthetic steroid danazol; alternatively, attacks can be controlled by giving either C1 inhibitor concentrate or ϵ -aminocaproic acid to inhibit the plasmin.

the Bruton's tyrosine kinase (*Btk*) gene, as is also seen in *xid* mice. The children are subject to repeated infection by pyogenic bacteria – *Staphylococcus aureus*, *Streptococcus pyogenes* and *S. pneumoniae*, *Neisseria meningitidis*, *Haemophilus influenzae* – and by a protozoan, *Pneumocystis jirovecii*, which produces an unusual form of pneumonia. Cell-mediated immune responses are normal and viral infections are readily brought under control.

Mutations in either the μ heavy chain or the λ_5 chain, which together form the surrogate IgM receptor on pre-B-cells, result in a phenotype similar to that seen in XLA, with arrest at the pro-B stage. The comparable phenotype is because *Btk* provides the signal for pro- to pre-B differentiation through this pre-B-cell receptor complex. Other mutations that cause a similar phenotype include those in the genes for the $Ig\alpha$ (CD79a) signal-transducing protein and for the BLNK (B-cell linker) protein, which is again required for the transition from pro-B to pre-B-cells.

Deficiencies affecting particular antibody isotypes

The most common of all the primary immunodeficiencies is *selective IgA deficiency*. Both circulating IgA and the secretory dimeric form are affected and the phenotype can also broaden to include the IgG2 isotype. In some patients there is a complete absence of IgA, whereas others have low levels of these antibodies. The majority of patients with selective IgA deficiency are asymptomatic, presumably because the other classes of antibody (including IgM transported to mucosal surfaces by the poly-Ig receptor) are able to compensate. *Common variable immunodeficiency (CVID)*, in which there is low IgG and IgA and/or IgM, often occurs within the same family as patients with selective IgA deficiency, and individual family members sometimes gradually convert from one disease to the other. The gene defects for

Table 13.3 Some deficiencies affecting B-lymphocytes.

Defective gene	Disorder	Typical infections
<i>BAFFR</i> , <i>CD19</i> , <i>ICOS</i> , <i>TACI</i> , <i>MHC class II</i> , various complement components, <i>MSH5</i> , <i>substance P</i>	Common variable immunodeficiency	<i>S. pneumoniae</i> , <i>H. influenzae</i> , <i>Mycoplasma</i> spp.
<i>Btk</i>	X-linked agammaglobulinemia	<i>S. aureus</i> , <i>S. pyogenes</i> , <i>S. pneumoniae</i> , <i>N. meningitidis</i> , <i>H. influenzae</i> , <i>Pneumocystis jirovecii</i>
<i>Ig Cμ</i> , λ_5 , <i>Igα</i> or <i>BLNK</i>	–	<i>S. aureus</i> , <i>S. pyogenes</i> , <i>S. pneumoniae</i> , <i>N. meningitidis</i> , <i>H. influenzae</i> , <i>Pneumocystis jirovecii</i>
Unknown	Selective IgA deficiency	Mostly asymptomatic, sometimes bronchopulmonary infections
ADA, RAG-1, RAG-2, Artemis, AK2	B-SCID	Broad (viral, bacterial, fungal)

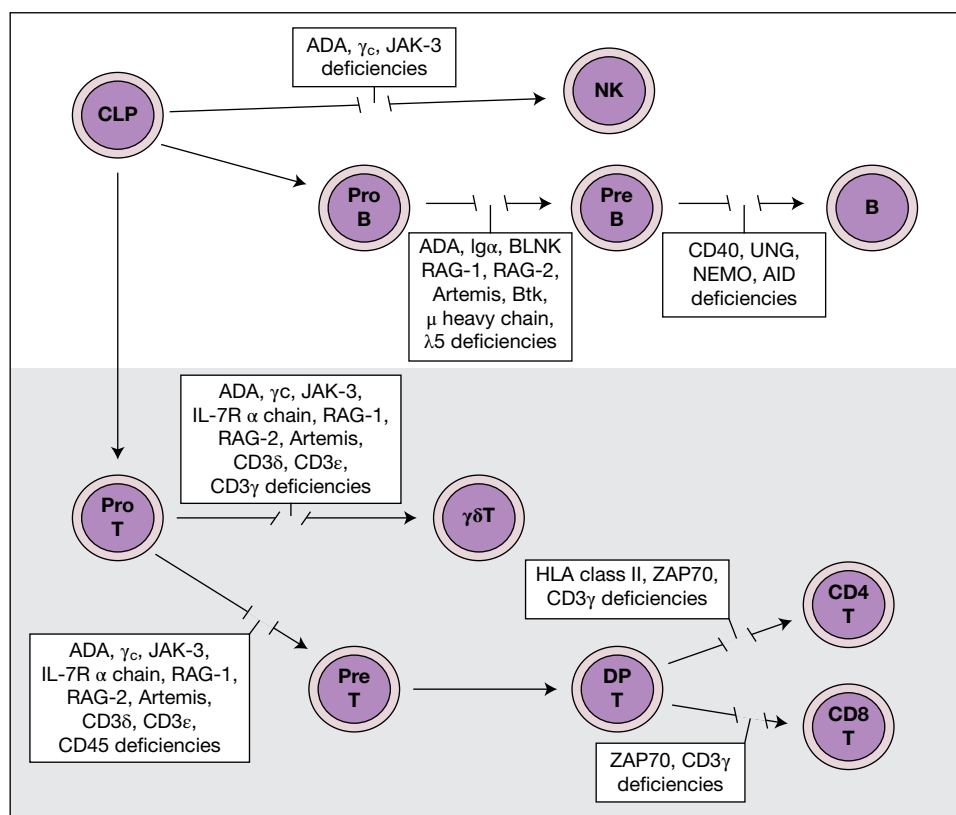


Figure 13.8 Blocks in lymphoid cell development result in immunodeficiency. The site and nature of the mutation will determine the extent to which the function of the gene product is compromised. Thus, although homozygous inheritance of the mutated gene will often lead to an absolute block in development of the relevant lymphocyte populations, some mutations only cause a partial block in development. Furthermore, even some loss of function mutations will only partially abrogate lymphocyte differentiation. This is the case with CD3 γ chain and HLA class II deficiencies where the consequences are usually less severe than in many other immunodeficiencies. ADA, adenosine deaminase; AID, activation-induced cytidine deaminase; CLP, common lymphoid progenitor; DP, double positive; RAG, recombination-activating gene.

both these PIDs in most patients have yet to be fully defined but mutations in quite a few genes have been described in small numbers of CVID patients, including the genes encoding TAC1, CD19, ICOS, Substance P, MHC class II, complement components, the mismatch repair protein MSH5, and the B-cell surface BAFF receptor. Patients with these antibody deficiencies can be protected against recurrent pyogenic infections with intravenous or subcutaneous injections of pooled human immunoglobulin.

Transient hypogammaglobulinemia is seen in early life

A degree of immunoglobulin deficiency occurs naturally in human infants as the maternal IgG level wanes, and may become a serious problem in very premature babies. A more protracted *transient hypogammaglobulinemia of infancy*, characterized by recurrent respiratory infections, is associated with low IgG levels that often return to normal by 4 years of age. There is a deficiency in the number of circulating lymphocytes and in their ability to generate help for

Ig production by B-cells, but this becomes normal as the disease resolves spontaneously.

Primary T-cell deficiency (Table 13.4)

Patients with no T-cells or poor T-cell function are vulnerable to opportunistic infections and, as B-cell function is to a large extent T-cell dependent, T-cell deficiency also impacts negatively on humoral immunity. Dysfunctional T-cells often permit the emergence of allergies, lymphoid malignancies, and autoimmune syndromes, the latter presumably arising from inefficient negative selection in the thymus or the failure to generate appropriate regulatory cells.

Defective thymic development

The *DiGeorge syndrome*, in which mutations in the TBX1 transcription factor involved in embryonic development are present, is characterized by a failure of the thymus to develop properly from the third and fourth pharyngeal pouches (DiGeorge syndrome children also lack parathyroids and have severe

Table 13.4 Some deficiencies affecting T-lymphocytes.

Defective gene	Disorder	Typical infections
<i>AIRE</i>	Autoimmune polyendocrine syndrome 1	<i>Candida albicans</i>
<i>ATM</i>	Ataxia telangiectasia	Bronchopulmonary
<i>CIITA</i>	MHC class II deficiency	Bronchopulmonary
<i>CD3γ</i>	CD3 γ deficiency	Bacteria and viruses
<i>CD40L</i> , <i>CD40</i> , <i>AID</i> , <i>NEMO</i> , or <i>UNG</i>	Hyper-IgM syndrome	<i>Pneumocystis jirovecii</i> , <i>Toxoplasma</i> , <i>Cryptosporidium parvum</i>
<i>FAS</i> or <i>FASL</i>	Autoimmune lymphoproliferative syndrome	None
<i>Foxp3</i>	Immune dysregulation, polyendocrinopathy, enteropathy, X-linked (IPEX)	None
γ C, <i>RAG-1</i> , <i>RAG-2</i> , <i>artemis</i> , <i>ADA</i> or <i>IL-7R α chain</i>	Omenn syndrome	Broad (viral, bacterial, fungal)
γ C, <i>RAG-1</i> , <i>RAG-2</i> , <i>artemis</i> , <i>ADA</i> , <i>AK2</i> , <i>JAK3</i> , <i>IL-7R α chain</i>	SCID	Broad (viral, bacterial, fungal)
<i>NBS1</i>	Nijmegen breakage syndrome	Bronchopulmonary
<i>PNP</i>	PNP deficiency	Broad (viral, bacterial, fungal)
<i>SH2DIA</i>	X-linked lymphoproliferative disease type 1	Epstein–Barr virus
<i>STAT3</i>	Hyper-IgE syndrome	Extracellular bacteria, staphylococci, <i>Aspergillus</i> spp., <i>C. albicans</i>
<i>TAP-1</i> , <i>TAP-2</i> , or <i>tapasin</i>	MHC class I deficiency	Brochopulmonary
<i>TBX1</i>	DiGeorge syndrome	Multiple
<i>WASP</i>	Wiskott–Aldrich syndrome	Encapsulated extracellular bacteria

cardiovascular abnormalities). Consequently, hematopoietic stem cells cannot differentiate to become T-lymphocytes and the “thymus-dependent” areas in lymphoid tissue are sparsely populated; in contrast, lymphoid follicles are seen but even these are poorly developed. Cell-mediated immune responses are undetectable and, although the infants can deal with common bacterial infections, they may be overwhelmed by live attenuated vaccines such as measles or BCG if given by mistake. Antibodies can be elicited, but the response is subnormal, reflecting the need for the cooperative involvement of T-cells. Treatment by grafting neonatal thymus leads to restoration of immunocompetence, but some matching between the MHC on the nonlymphocytic thymus cells and peripheral cells is essential for the proper functioning of the T-lymphocytes. Complete absence of the thymus is pretty rare and more often one is dealing with partial DiGeorge syndrome in which the T-cells may rise from 6% at birth to around 30% of the total circulating lymphocytes by the end of the first year (compared with 60–70% in normal 1-year-olds); antibody responses are adequate.

Arrest of early T-cell differentiation

Mutation of the gene encoding the purine degradation enzyme *purine nucleoside phosphorylase* results in the accumulation of the metabolite deoxy-GTP in mitochondria. It has been

proposed that this prevents normal maintenance of mitochondrial DNA leading to release of cytochrome *c* from the mitochondria and the induction of apoptosis, particularly in CD4⁺ CD8⁺ (double positive) thymocytes. Some T-cells “leak through” but they give inadequate protection against infection and the disease is usually fatal unless a hematopoietic stem cell transplant life-line is offered. In addition to recurrent infections, patients usually have neurologic dysfunction and autoimmunity.

Quite a few different genes, including for *RAG-1*, *RAG-2*, *Artemis*, *IL-7* receptor α chain, adenosine deaminase, and the γ _c shared interleukin receptor chain, have been linked to the development of **Omenn syndrome**. As we shall see shortly, mutations of these genes are also responsible for severe combined immunodeficiency (SCID), but in Omenn syndrome the particular mutations involved are “leaky” and result in a less devastating phenotype. For example, the mutations in *RAG* allow some T-cells to sneak through because VDJ recombination is not completely abolished. Patients often exhibit eosinophilia and raised IgE, and sometimes have autoimmune disease affecting the skin and gut.

MHC class II deficiency (sometimes referred to as “bare lymphocyte syndrome”) is associated with recurrent bronchopulmonary infections and chronic diarrhea occurring within the first year of life, with death from overwhelming viral infections

at a mean age of 4 years unless these affected infants are successfully treated with a hematopoietic stem cell transplant. The condition arises from mutations affecting any of several transcription factors controlling the expression of class II genes, for example the class II transactivator (CIITA). Feeble expression of class II molecules on thymic epithelial cells grossly impedes the positive selection of CD4⁺ T-cells, and those that do leak through will not be encouraged by the lack of class II on antigen-presenting cells. Note also that rare patients with mutations in the *TAP-1*, *TAP-2*, or *tapasin* genes have MHC class I deficiency.

Deficiencies leading to dysfunctional T-cell–B-cell collaboration

Cell-mediated immunity (CMI) is depressed in immunodeficient patients with thrombocytopenia and eczema (*Wiskott–Aldrich syndrome*) or with *ataxia telangiectasia*. The Wiskott–Aldrich syndrome protein (*WASp*) plays a critical role in linking signal transduction pathways and the actin-based cytoskeleton by clustering physically with actin through the GTPase Cdc42 and the Arp2/3 (actin-related protein) complex that regulates actin polymerization. Mutations in the *WASP* gene on the X chromosome thus adversely affect T-cell motility, phagocyte chemotaxis, dendritic cell (DC) trafficking, and the polarization of the T-cell cytoskeleton towards the B-cells during T-cell–B-cell collaboration. Poor CMI and impaired antibody production in affected boys are hardly surprising consequences. *Ataxia telangiectasia*, a chromosomal breakage syndrome, is an autosomal recessive disorder of childhood characterized by progressive cerebellar ataxia with degeneration of Purkinje cells, a hypersensitivity to X-rays, and an unduly high incidence of cancer. The ataxia telangiectasia mutated (*ATM*) gene encodes the Atm protein kinase, a member of the phosphatidylinositol 3-kinase family involved in regulating cell cycle and DNA double-stranded break repair. Furthermore, the Atm kinase is required for hematopoietic stem cell self-renewal by inhibiting oxidative stress in these cells. Another disease characterized by immune dysfunction, radiation sensitivity, and increased incidence of cancer is the *Nijmegen breakage syndrome*, in which there is a mutation in the *NBS1* gene encoding nibrin, a component of the double-stranded DNA break repair complex that becomes phosphorylated by Atm. Both Atm and nibrin are required for efficient class-switch recombination in B-cells.

The names of some clinical conditions might not at first glance suggest that they are immunodeficiencies. Take for instance the *hyper-IgM syndrome*, in which there are often raised concentrations of serum IgM and IgD. This rare disorder is characterized by recurrent bacterial infections and very low levels or absence of IgG, IgA, and IgE. Most patients have an X-linked form of the disease involving point mutations and deletions in the gene encoding the T-cell CD40L (CD154) molecule. These mutations largely map to the part of the molecule involved in the interaction with B-cell CD40, thereby rendering the T-cells incapable of transmitting the signals needed for Ig class switching in B-cells. Less commonly,

mutation of the X-linked *NEMO* gene (NFκB essential modifier, alternatively known as IKKγ), or the autosomal *CD40*, activation-induced cytidine deaminase (*AID*), or uracil-DNA glycosylase (*UNG*) genes are responsible. In these cases it is the B-cells, rather than the helper T-cell, that are defective.

The most common genetic cause of *hyper-IgE syndrome* (*HIES*) is a mutation in the *STAT3* gene. In addition to elevated IgE levels there are decreased numbers of Th17 cells. The HIES phenotype also includes several distinctive anatomical features such as hyperextensible joints and a failure or delay in shedding primary teeth so that patients have two sets of teeth.

Rare cases of T-cell functional deficiency arise from mutation in the γ chain of the CD3 complex, in which patients have normal levels of circulating T-cells but with a reduced expression of T-cell receptors on their cell surface, and ZAP-70 kinase mutations that result in reduced numbers of CD8⁺ T-cells.

Some immunodeficiencies can rather paradoxically cause an overactive immune response

We have already mentioned that excessive production of certain classes of antibody (IgM or IgE, for example) can result from particular gene defects. It is now also clear that “immunodeficiency” affecting regulatory or tolerance mechanisms will result in an undesirable enhancement of particular types of immune response. Thus, given the important role of Foxp3 in the induction of regulatory T-cells, it will come as no surprise to hear that loss-of-function mutations in the *Foxp3* gene have a profound effect, being responsible for the *IPEX* (immune dysregulation, polyendocrinopathy, enteropathy, X-linked) syndrome, in which unregulated T-cell activity leads to multisystemic and often fatal autoimmune disease. The somewhat less severe clinical condition *autoimmune polyendocrine syndrome-1* (*APS-1*), sometimes referred to as APECED (autoimmune polyendocrinopathy with candidiasis and ectodermal dystrophy), is caused by mutations in the *AIRE* gene leading to inadequate central tolerance of T-cells. In contrast, APS-2 is genetically much more complex and, like the vast majority of autoimmune diseases (see Chapter 17), is not caused by a single-gene defect.

Defects in either Fas (CD95) or Fas ligand (CD95L) lead to *autoimmune lymphoproliferative syndrome* (*ALPS*), in which there is defective lymphocyte apoptosis resulting in increased numbers of CD4⁺CD8⁻ (double negative) T-cells in the peripheral blood and the development of autoimmune disease.

Severe combined immunodeficiency (SCID)

In the primary T-cell deficiencies described above there are at least some mature T-cells present, albeit functionally defective. However, in *severe combined immunodeficiency disease* (*SCID*) there is normally an absolute failure in T-cell development and therefore SCID represents the most severe form of primary immunodeficiency, affecting one child in

approximately every 80 000 live births. These infants exhibit profound defects in cellular and humoral immunity and without medical intervention death occurs within the first year of life owing to severe and recurrent opportunistic infections. Prolonged diarrhea resulting from gastrointestinal infections and pneumonia due to *Pneumocystis jirovecii* are common; *Candida albicans* grows vigorously in the mouth or on the skin. If vaccinated with attenuated organisms these immunocompromised infants usually die of progressive infection.

Several different gene defects can be responsible for the development of SCID

Mutations in several different genes can cause SCID, which involves a block in T-cell development together with a direct or indirect B-cell deficiency. In some cases NK cells also fail to develop (see Figure 13.8).

Cytokine signaling pathway defects

Approximately 40% of patients with SCID have mutations in the **common γ (γ_c) chain** of the receptors for interleukins IL-2, IL-4, IL-7, IL-9, IL-15, and IL-21. Of these, IL-7R is the most crucial for lymphocyte differentiation, and mutations in the **IL-7R α chain**, or in **JAK-3**, which transduces the γ_c signal, also result in SCID (Figure 13.9).

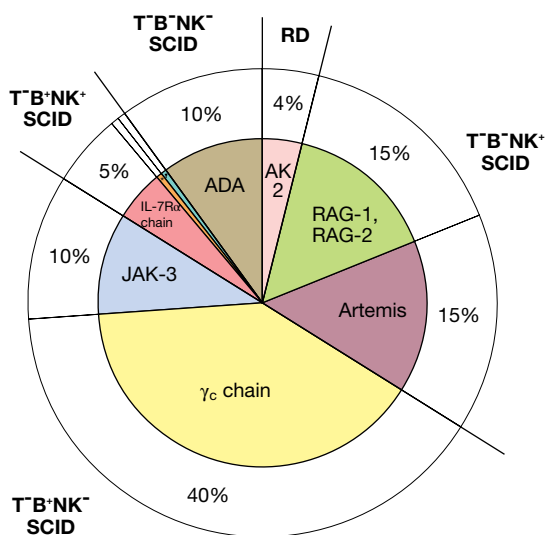


Figure 13.9 Genetic defects responsible for severe combined immunodeficiency (SCID). The SCID phenotype is dependent upon the particular gene defect that is responsible. For example, in the 15% of SCID cases caused by mutation of the *Artemis* gene there is a complete lack of both T- and B-cells but NK cells are present (i.e., T-B-NK⁺ SCID) whereas in the 10% of cases due to ADA gene defects NK cells are also lacking (T-B-NK⁻ SCID). Mutations in CD3 δ , CD3 ϵ , CD3 ζ , or CD45, (*) or the actin-regulator coronin-1A (†) each account for <1% of SCID cases. Mutations in the AK2 gene give rise to reticular dysgenesis (RD). There may be a few rare cases of SCID in which other gene mutations are responsible.

SCID can arise from grossly deficient VDJ recombination

Unlike the sneak through of immunocompetent T-cells that accompanies the partial *RAG* deficiency in Omenn syndrome, grossly dysfunctional mutations in the recombinase enzymes, which catalyze the introduction of the double-stranded breaks permitting subsequent recombination of the *V*, *D*, and *J* segments of the immunoglobulin and T-cell receptor gene loci, prevent the emergence of any mature lymphocytes (see Figure 13.8). Failure of the VDJ recombination mechanism is also a feature of SCID patients with a defective *Artemis* gene. *Artemis* is an essential component of the DNA-dependent protein kinase complex that realigns and repairs the free coding ends created by the *RAG* enzymes.

Other causes of SCID

Ten percent of SCID patients have a genetic deficiency of the purine degradation enzyme adenosine deaminase (ADA), which results in the accumulation of the metabolite dATP, which is toxic to early lymphoid progenitor cells (see Figure 13.8). If either the CD3 δ or ϵ chain of the T-cell receptor complex is mutated there is a block in T-cell development, in marked contrast to CD3 γ chain deficiency which does not prevent T-cell differentiation but does result in defective T-cell activation. Mutations of the CD45 protein tyrosine phosphatase can also give rise to SCID in very rare instances. **Reticular dysgenesis**, in which there are mutations in the mitochondrial adenylate kinase-2 (*AK2*) gene, is a rapidly fatal variant of SCID associated with a block in the differentiation of both myeloid and lymphoid cell precursors.

Combined immunodeficiency resulting from inherited defective control of lymphocyte function

X-linked lymphoproliferative disease (XLP), or Duncan's syndrome, is a progressive immunodeficiency disorder characterized by fever, pharyngitis, lymphadenopathy, and dysgammaglobulinemia (i.e., a selective deficiency of one or more, but not of all, the classes of antibody). Patients are particularly vulnerable to Epstein-Barr virus (EBV) infection. Mutations occur in the *SH2DIA* gene encoding SAP (signaling lymphocytic activation molecule (SLAM)-associated protein), which binds to SLAM through its SH2 domain. As triggering of SLAM leads to strong induction of IFN γ in T-cells and acts on B-cells to enhance proliferation and increase susceptibility to apoptosis, mutations in SAP that adversely affect the activation of SLAM will weaken the immune response, especially with regard to EBV infection in which viral replication in B-cells is heavily controlled by host T-cells.

Diagnosis of primary immunodeficiencies

Defects in immunoglobulins can be assessed by quantitative estimations; levels of <200 mg/dL suggest an antibody deficiency. The humoral immune response can be examined by

screening the serum of individuals >6 months of age for IgM natural antibodies to bacterial polysaccharides and, in those who are not blood group AB, to the A and B blood group antigens (A and B isohemagglutinins). IgG antibody responses can be measured following vaccination with tetanus toxoid, diphtheria toxoid, *Haemophilus influenzae* type B, and other subunit or killed vaccines – but no live vaccines. CD19, CD20, and CD22 are the main markers used to enumerate B-cells by immunofluorescence.

Patients with T-cell deficiency will be hypo- or unreactive in skin tests to such antigens as tuberculin, *Candida*, and mumps. The reactivity of peripheral blood mononuclear cells to the phytohemagglutinin mitogen is a good indicator of T-lymphocyte reactivity, as is also the one-way mixed lymphocyte reaction (see Chapter 15). Enumeration of T-cells is most readily achieved by flow cytometry using CD3, CD4, and CD8 monoclonal antibodies. T-cell receptor excision circles (TRECs), circular DNA molecules that result from TCR gene recombination, can be measured by polymerase chain reaction (PCR) and are used to quantify recent thymic emigrants as a measure of T-cell output from the thymus.

In vitro tests for complement and for the bactericidal and other functions of neutrophils are available. The absence of an oxidative (respiratory) burst in neutrophils from patients with chronic granulomatous disease can be detected by incubation of leukocytes with dihydrorhodamine 123 (DHR) and catalase followed by activation with phorbol 12-myristate 13-acetate (PMA). The ability of the neutrophils to oxidize DHR to rhodamine is then detected using flow cytometry.

If the above tests are suggestive of primary immunodeficiency, the diagnosis can be confirmed by genetic testing for mutations in the relevant gene.

Treatment of primary immunodeficiencies

Early intervention with antibiotics and antifungals is of immediate importance, with the option of long-term low-dose prophylactic antimicrobials to prevent reinfection and subsequent complications such as hearing loss following otitis media (infection of the middle ear).

Replacing the missing components

As already mentioned earlier, if a suitable matched donor is available, then bone marrow, cord blood, or adult peripheral blood hematopoietic stem cell transplantation is the treatment of choice and has led to reconstitution of immune responses in patients with various primary immunodeficiencies including SCID, leukocyte adhesion deficiency, Chédiak–Higashi disease, and Wiskott–Aldrich syndrome. In patients with ADA-SCID for whom no matched donor is available, the missing enzyme can be replaced by weekly intramuscular injections of bovine ADA conjugated to polyethylene glycol; this phenomenonally improves the biological half-life of ADA from a few minutes for the free enzyme to 48–72 hours for the conjugate.

Deficiencies affecting humoral responses can, to some extent, be compensated for by intravenous immunoglobulin

(IVIg) given every 3–4 weeks. Cytokine therapy with G-CSF to boost neutrophil numbers in patients with neutropenia, IFN γ to stimulate phagocytes in patients with CGD, or IL-2 to stimulate lymphocytes in those affected by CVID can be helpful.

Gene therapy

The ideal treatment for patients in which a matched transplant is not available is correction of the gene defect. The first gene therapy trials for primary immunodeficiencies were initiated over 20 years ago and there has been a steady improvement in this approach, with some setbacks along the way. The majority of patients treated by this procedure have been those with ADA-SCID, in which the normal gene for ADA is inserted into a retroviral vector that is then used to introduce the functional gene into the patient's own CD34⁺ hematopoietic stem cells (Figure 13.10). More recently this approach has been extended to the replacement of the defective γ_c cytokine receptor gene in patients with this form of SCID, although in this case more caution is required as some of these patients have developed leukemia following treatment. However, in both types of SCID the gene therapy approach has led to a sustained clinical benefit with restoration of immune responses to common pathogens. Clinical trials using the gene encoding the Wiskott–Aldrich syndrome protein (WASp) in patients with Wiskott–Aldrich syndrome have also resulted in the development of leukemia in some patients. A small number of patients with the X-linked form of chronic granulomatous disease have been treated with a functional *gp91^{phox}* gene but generally with only short-term benefit. Future progress will depend upon improvements in vector design to enhance the safety and efficiency of the gene transfer, and facilitate a more precise targeting of the gene integration sites. The use of self-inactivating lentiviral vectors (lentiviruses, which include HIV, are a sub-family of retroviruses) incorporating tissue-specific promoters is being explored in current clinical trials.

Secondary immunodeficiency

Immune responsiveness can be depressed nonspecifically by many factors. CMI in particular may be impaired in a state of malnutrition, even of the degree which may be encountered in urban areas of the more affluent regions of the world. Iron deficiency is particularly important in this respect, as are zinc and selenium deficiencies.

Viral infections are not infrequently immunosuppressive, and the profound fall in CMI that accompanies **measles infection** has been attributed to specific suppression of IL-12 production by viral cross-linking of monocyte surface CD46 (membrane cofactor protein). The most notorious immunosuppressive virus, human immunodeficiency virus (HIV), will be elaborated upon in the next section. In lepromatous leprosy and malarial infection there is evidence for a constraint on immune responsiveness imposed by distortion of the normal lymphoid traffic pathways and, additionally, in the latter

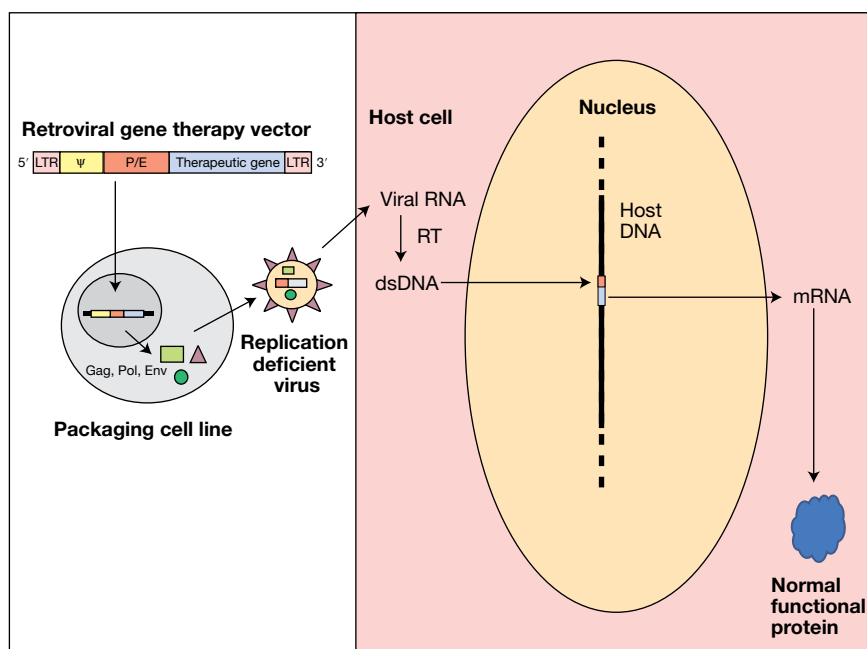


Figure 13.10 Gene therapy. In a typical retroviral vector the Gag (core protein), Pol (reverse transcriptase [RT]) and Env (viral envelope) genes are replaced with the therapeutic gene, together with appropriate promoter (P) and enhancer (E) regulatory sequences. The 5' and 3' long terminal repeats (LTR) include sequences involved in gene integration, and the ψ (psi) sequence directs packaging of the viral nucleic acid. The retroviral vector containing the therapeutic gene is transfected into a packaging cell line that contains previously integrated genes encoding the essential Gag, Pol, and Env proteins. The virus particles that are produced by this cell line will lack the genes for these proteins and therefore cannot go on to produce further infectious particles following delivery of the therapeutic gene to the host hematopoietic stem cells. In the patient's cells the viral RNA is reverse transcribed into double-stranded DNA that subsequently integrates into the host chromosomal DNA. The therapeutic gene can then be transcribed into mRNA for production of a functional form of the previously defective protein.

instance, macrophage function appears to be aberrant. Skewing of the balance between Th1 and Th2 cells as a result of infection may also depress the subset most appropriate for immune protection.

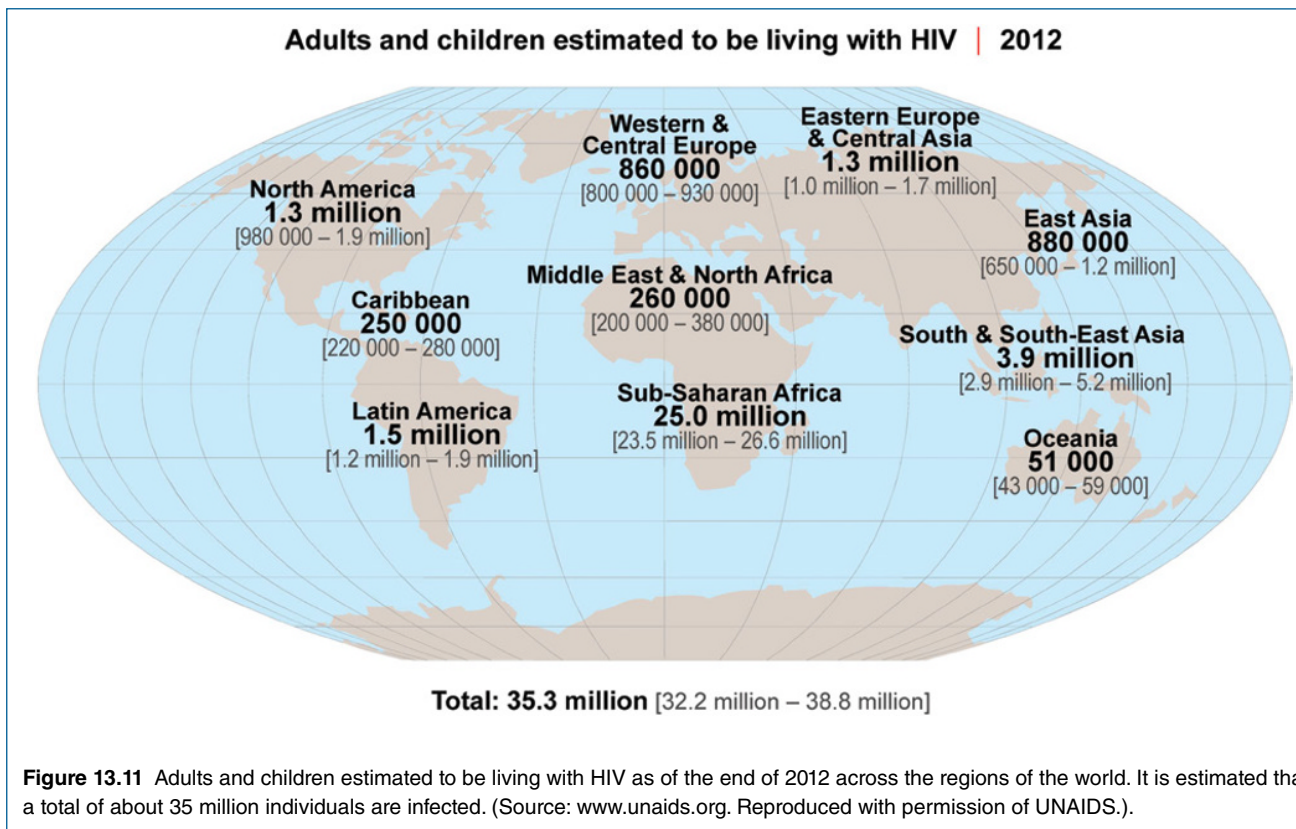
Many therapeutic agents, such as X-rays, cytotoxic drugs, and corticosteroids, can have dire effects on the immune system. **B-lymphoproliferative disorders**, such as chronic lymphocytic leukemia, myeloma, and Waldenstrom's macroglobulinemia, are associated with varying degrees of hypogammaglobulinemia and impaired antibody responses. Their common infections with pyogenic bacteria contrast with the situation in Hodgkin's disease in which the patients display all the hallmarks of defective CMI – susceptibility to tubercle bacillus, *Brucella*, *Cryptococcus*, and herpes zoster virus.

Acquired immunodeficiency syndrome (AIDS)

Acquired immunodeficiency syndrome (AIDS) is a devastating illness that had killed more than 25 million people by the end of 2008. According to the 2013 UNAIDS report, approximately 35 million people were living in 2012 with human immunodeficiency virus (HIV), the agent responsible for AIDS

(Figure 13.11). There were approaching 2.3 million new infections in 2012 but this was down on previous years. The epicentre of the plague is sub-Saharan Africa with nearly two-thirds of worldwide HIV infections, an adult infection rate estimated at about 5%, and more than a million deaths in 2012. Increasingly, HIV/AIDS has a female face; females over 16 years of age account for nearly 50% of all people living with HIV or AIDS (closer to 60% in sub-Saharan Africa). Another key demographic is that children under 15 years of age account for about 10% of all infected individuals.

The first reported case of AIDS was in 1981. The syndrome was characterized by a predisposition to opportunistic infections (i.e., those easily warded off by a normally functioning immune system); the incidence of an aggressive form of Kaposi's sarcoma or B-cell lymphoma; and the concurrent depletion of CD4⁺ T-cells. It was suspected that AIDS was caused by a previously unknown virus as it spread through contact with bodily fluids, and in 1983, HIV-1 was isolated and identified. There are in fact two closely related HIVs, HIV-1 and the less virulent HIV-2, which differ both in origin and sequence. The majority of AIDS cases are caused by HIV-1. HIV-2 is found predominantly in West Africa.



Both HIV-1 and HIV-2 have their origins in nonhuman primates. Based on sequence similarities (Figure 13.12) with simian immunodeficiency viruses (SIVs), HIV is likely the evolutionary product of closely related SIVs that crossed from their nonhuman primate hosts into humans in the early to mid part of the twentieth century. The closest relative of HIV-1 is SIV_{cpz}, the natural host of which is the chimpanzee, *Pan troglodytes*. HIV-2 is more closely related to SIV_{smm} from the sooty mangabey, *Cercocebus atys*. Phylogenetic mapping and sequence analyses indicate several independent zoonoses of SIV_{cpz} and SIV_{smm} within the past century. The leading hypothesis is that SIV_{cpz} and SIV_{smm} were transmitted to humans through cutaneous or mucosal membrane exposure to infected animal blood. This scenario is consistent with regular direct exposure of hunters in the bushmeat trade to primate blood.

Based on viral sequences, HIV-1 is categorized into four groups: M (main), O (outlier), N (non-M, non-O), and P (a virus likely transmitted to humans from gorillas) each representing separate zoonoses (Figure 13.12). HIV-2 is similarly categorized into eight groups, A through H. HIV-1 from group M has spread throughout the world and is further subcategorized into clades A through K, which predominate in different geographical regions. The other three groups, N, O, and P, are mainly confined to Gabon, Cameroon, and neighboring countries in West Africa.

The evolution of the different group M clades most probably occurred within the human population following one

cross-species transmission event. The discovery of an HIV-1 isolate from 1959 that appears to be an ancestor of clades B and D is consistent with this viewpoint. Furthermore, the discovery of a second isolate from 1960 that is highly divergent from the 1959 isolate shows that the virus had already undergone substantial diversification 50 years ago. The oldest common ancestor of group M has been estimated to date to the early part of the twentieth century, suggesting that HIV-1 has been infecting humans longer than originally thought, unnoticed clinically among populations in West Central Africa. The early spread of AIDS may have resulted from various economic, social, and behavioral factors (e.g., use of nonsterilized needles for parenteral injections and vaccinations) that facilitated virus transmission.

HIV does not usually cause AIDS immediately and controversy still remains as to precisely how the virus damages the immune system and whether all HIV-1 infected individuals will necessarily develop disease. Great strides have been made since the identification of HIV but much remains a puzzle and a cure or a vaccine are elusive.

The clinical course of disease: from infection to AIDS

Initial infection generally occurs by exposure to bodily fluids from an infected individual. HIV is found as free virus particles and infected cells in semen, vaginal fluid, and mother's milk.

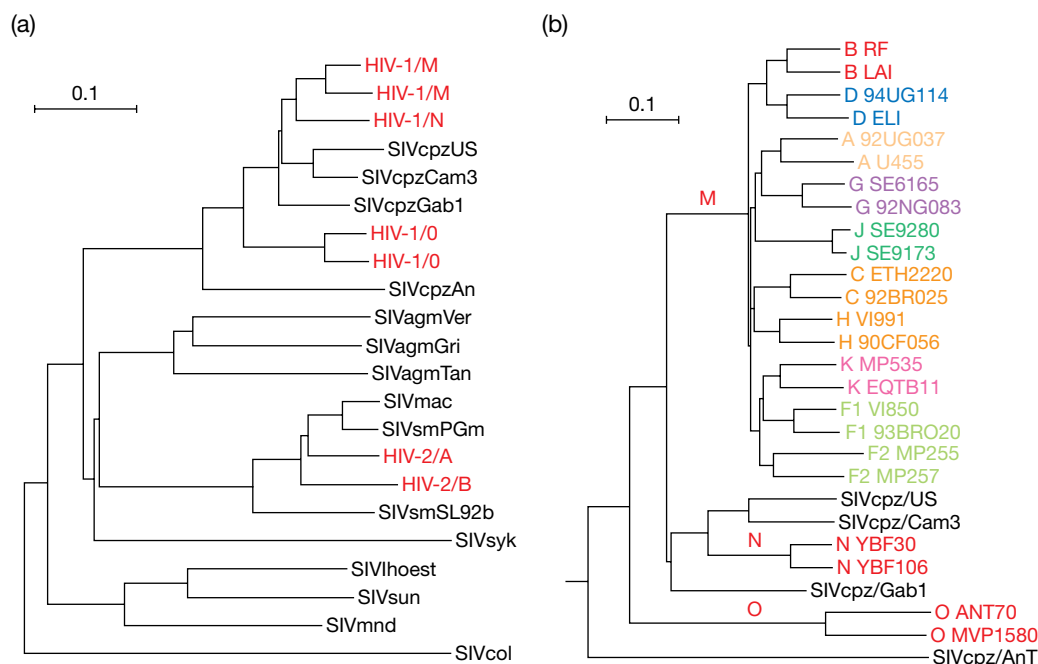


Figure 13.12 Evolution of AIDS viruses. Two evolutionary trees are shown in which the scale bar indicates 10% protein sequence divergence. (a) Tree showing the origins of primate lentiviruses. SIV strains have a suffix indicating their species of origin (e.g., SIV_{cpzUS} is SIV from a chimpanzee in captivity in the United States). The distinct origins of HIV-1 and HIV-2 (shown in red) are apparent. This tree was derived using Pol protein sequences. (b) Tree showing the relationship between HIV-1 groups and clades and SIV_{cpz}. This tree was derived from Env protein sequences. (Source: Sharp P.M. (2002) *Cell* **108**, 305–312. Reproduced with permission of Elsevier.)

Currently, the most common route of transmission worldwide is through sexual intercourse. The use of contaminated needles for intravenous drug delivery and the use of blood or blood products for therapeutic purposes are also common means of infection with HIV. Screening the blood supply for HIV has virtually eliminated transmission via the inadvertent administration of infected human blood in developed countries. Another important route of transmission is from infected mothers to their children. Mothers can pass HIV to their child either during birth or by breastfeeding. The chance of perinatal transmission can be significantly reduced if the mother is undergoing antiretroviral therapy.

Between 2 and 8 weeks after infection (Figure 13.13), more than 50% of individuals experience symptoms of acute viremia. These symptoms are reminiscent of a bout of influenza and include a high spiking fever, sore throat, headaches, and swollen lymph nodes. This is referred to as the acute retroviral syndrome, the symptoms of which usually subside spontaneously in 1–4 weeks. During this acute phase, there is an explosion of viral replication, particularly in CD4⁺ T-cells in the gut, and a corresponding marked decline in circulating CD4⁺ T-cells. At this time, most individuals also launch a strong HIV-specific CD8⁺ T-cell response (Figure 13.13) that kills infected cells, followed by the production of HIV-specific antibodies (seroconversion). CD8⁺ T-cells are thought to be important for controlling primary viremia. Virus levels spike, then fall as CD4⁺ T-cell counts rebound but to levels still below normal (800

cells/mL compared with 1200 cells/mL). The baseline level of virus persisting in the blood after the symptoms of acute viremia subside (the “set point”) is currently the best indicator for an individual’s prognosis.

Following primary infection, a period of clinical latency (no or few symptoms) follows, during which time HIV continues to replicate while CD4⁺ T-cells gradually decline in function and number. There are several mechanisms proposed to contribute to the depletion of CD4⁺ T-cells during HIV infection. First, there are the direct cytopathic effects of the virus on its host T-cell. Second, infected cells have an increased susceptibility to the induction of apoptosis. Third, “bystander” effects can lead to the demise of uninfected cells by exposure to viral products or molecules leading to immune activation. Finally, there is the elimination of infected CD4⁺ T-cells by CD8⁺ T-cells that recognize viral peptides displayed by MHC class I.

The great majority of HIV-infected individuals will, over the course of years, progress to AIDS. The asymptomatic period typically lasts somewhere between 2 and 15 years; however, the number of functional CD4⁺ T-cells eventually drops below a threshold (about 400 cells/mL) and opportunistic infections begin to appear. Once the CD4⁺ T-cell count has dropped below 200 cells/mL, the individual is classified as having AIDS.

In the earlier stages of HIV-1 disease, typical opportunistic microbes to evade the impaired cellular immune system are oral *Candida* species and *Mycobacterium tuberculosis*, which manifest as oral thrush and tuberculosis respectively. Later,

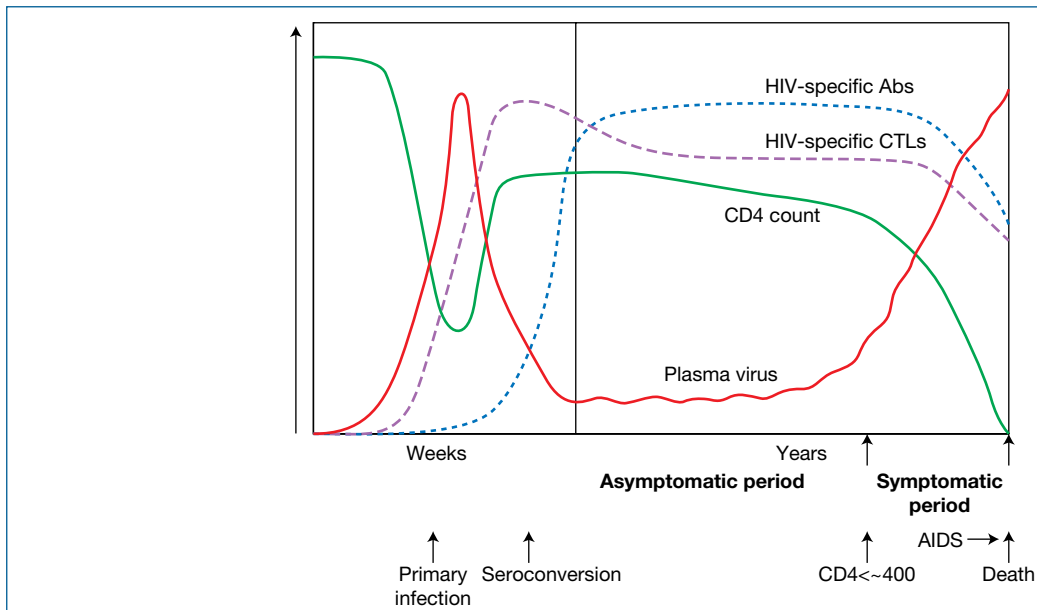


Figure 13.13 The typical course of HIV infection. Primary infection is characterized by a rapid rise in plasma virus and a rapid decline in circulating CD4⁺ T-cells. The plasma virus levels peak and decline to a low roughly constant level (“the set point”), which is predictive of the time of progression to disease. The CD4⁺ T-cell count recovers somewhat but to a lower level than prior to infection. The HIV-specific CD8⁺ T-cell response is activated as virus peaks and is probably important in controlling primary infection. The HIV-specific antibody response takes somewhat longer to initiate and results in seroconversion. The neutralizing antibody response is yet slower to initiate (see Figure 13.17). Clinical latency follows primary infection for a period of the order of a decade. No symptoms are apparent but depletion of CD4⁺ T-cells in lymphoid tissues continues. Eventually, CD4⁺ T-cell depletion is so pronounced that resistance to opportunistic infections begins to wane, leading ultimately to a complete collapse of a functioning immune system and death. Drug intervention can take plasma viral loads below the level of detection and prevent CD4⁺ T-cell depletion.

patients often suffer from shingles due to the activation of latent varicella zoster virus from a previous case of chickenpox. Also common is the development of EBV-induced B-cell lymphomas and Kaposi’s sarcoma, a cancer of endothelial cells, likely owing to the effects of cytokines secreted in response to both the existing HIV infection and a herpes virus (HHV-8) found in these tumors. Hepatitis C/HIV co-infection is also common and disease progression due to hepatitis C is accelerated. Pneumonia caused by the fungus *Pneumocystis jirovecii* is a frequent occurrence in patients and was often fatal prior to the introduction of effective antifungal therapy. In the final stages of AIDS, the prominent pathogens causing infection are *Mycobacterium avium* and cytomegalovirus. Respiratory infections are the major cause of death for people with AIDS. Although the above-mentioned infections and cancers are typical, not all people with AIDS will develop these illnesses and a number of other tumors and infections, though less prominent, are still of note.

The time of progression from HIV infection to AIDS varies greatly because of genetic variations in virus and/or host. For example, some viruses are naturally attenuated and are associated with slower disease progression. The HLA type of the host can be important. Homozygosity of HLA class I is linked to faster progression, probably due to a less diverse

T-cell response to the infection. Certain HLA types are associated with different prognoses: HLA-B57 and HLA-B27 are associated with slower progression whereas HLA-B35 is associated with more rapid progression. There are also individuals who are highly resistant to HIV infection because they have a mutation in the chemokine receptor CCR5, which serves as a co-receptor for HIV, as discussed later.

Two small groups of people are of particular interest to researchers owing to their ability to remain disease free after exposure to HIV. The first group, long-term nonprogressors, are clearly infected with virus but control virus replication at low levels and have not progressed to disease. Within this group, some individuals have barely detectable virus and are referred to as elite controllers. The second group, highly exposed seronegative individuals, have been repeatedly exposed to HIV yet remain disease free and have no detectable virus. Intriguingly, some members of this latter group appear to possess HIV-specific CD8⁺ T-cells suggesting previous exposure to the virus or at least to noninfectious viral antigens. Whether the immune response seen in these individuals is responsible for clearing an HIV infection is unclear. Nonetheless, these individuals are the focus of much interest for vaccine design and development. We will now review key aspects of the virus itself, including its cellular tropism, genome, and life cycle.

HIV-1 genome

HIV-1 is a retrovirus, which means that it has an RNA genome but that replication passes through DNA with the involvement of the enzyme reverse transcriptase. It belongs to a group of retroviruses called the lentiviruses, from the Latin *lentus* meaning “slow,” because of the slow course of disease associated with infection by these viruses. The HIV-1 genome is composed of approximately 9 kb of RNA, which consists of nine different genes encoding 15 proteins. Two copies of the single-stranded genome are packaged in the virus particle along with additional enzymes and accessory proteins. Three of the reading frames encode Gag (group-specific antigen), Pol (polymerase), and Env (envelope) polyproteins, which are proteolytically cleaved into individual structural proteins and enzymes (Figure 13.14). Gag is cleaved into four structural proteins, MA (matrix), CA (capsid), NC (nucleocapsid), and p6, while Env is cleaved into two, SU (surface gp120) and TM (transmembrane gp41). Pol cleavage produces the enzymes PR (protease), RT (reverse transcriptase), and IN (integrase),

which are encapsulated in the virus particle. Several accessory proteins are also encoded, three of which – Vif, Vpr, and Nef – are packaged inside the virus particle. The remaining accessory proteins are Tat, Rev, and Vpu. The functions of the 15 HIV proteins are summarized in Figure 13.14 and discussed in relation to the HIV life cycle below.

The life cycle of HIV-1

Viral entry

Initial virus–cell attachment is believed to be mediated primarily through nonspecific interactions between the envelope spikes that decorate the surface of the virus and target T-cell surface molecules. The envelope spike is a trimer of heterodimers composed of noncovalently associated surface glycoprotein (gp120) and transmembrane glycoprotein (gp41) subunits. The sugar moieties and positively charged patches on gp120 probably mediate binding to cell surface lectins and negatively charged heparan sulfate proteoglycans, respectively.

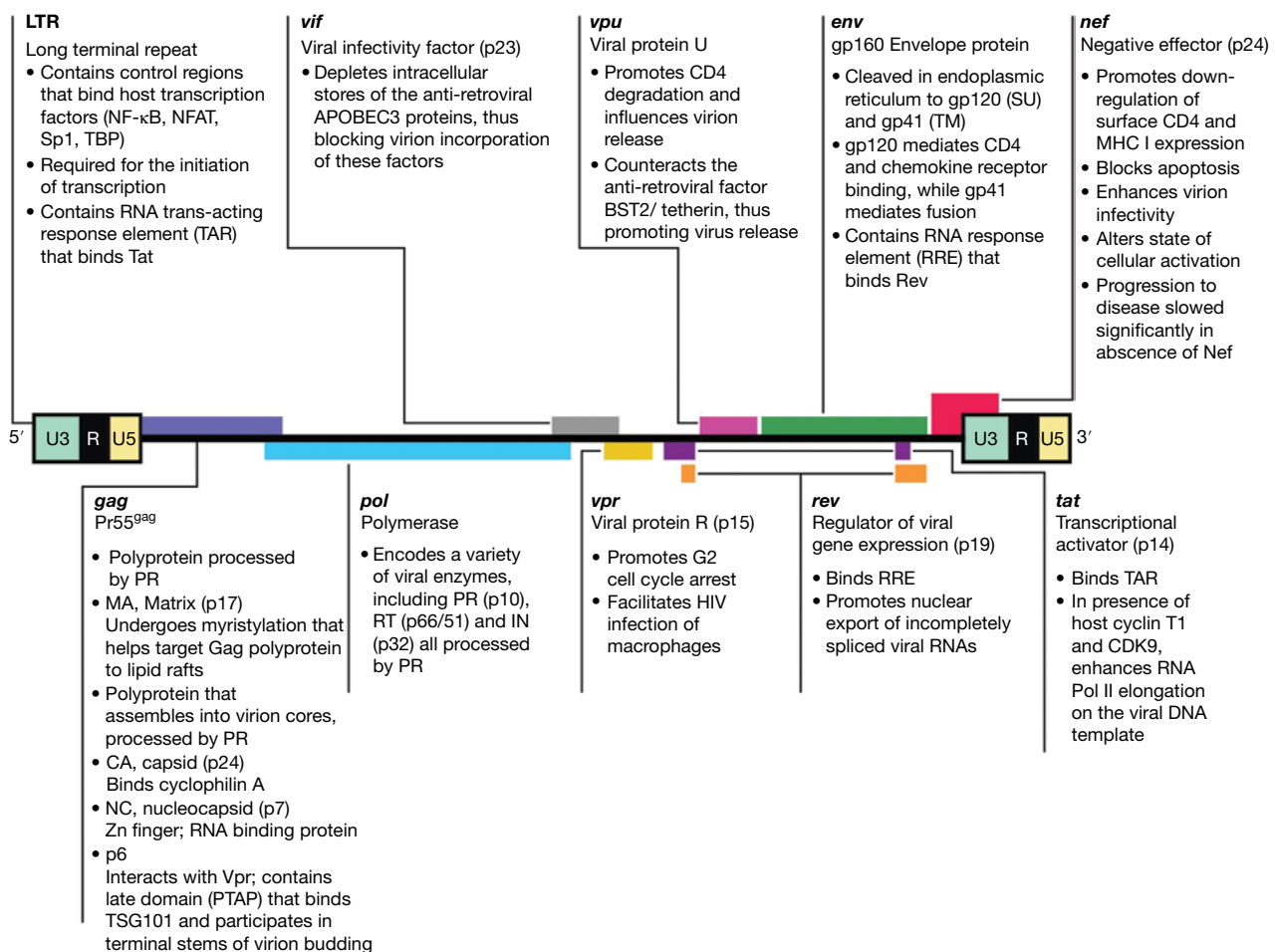


Figure 13.14 The HIV-1 genome. The organization of the genome is shown and the functions of the gene products summarized. (Source: Greene W.C. and Peterlin B.M. (2002) *Nature Medicine* 8, 673–680. Reproduced with permission of Nature Publishing Group.)

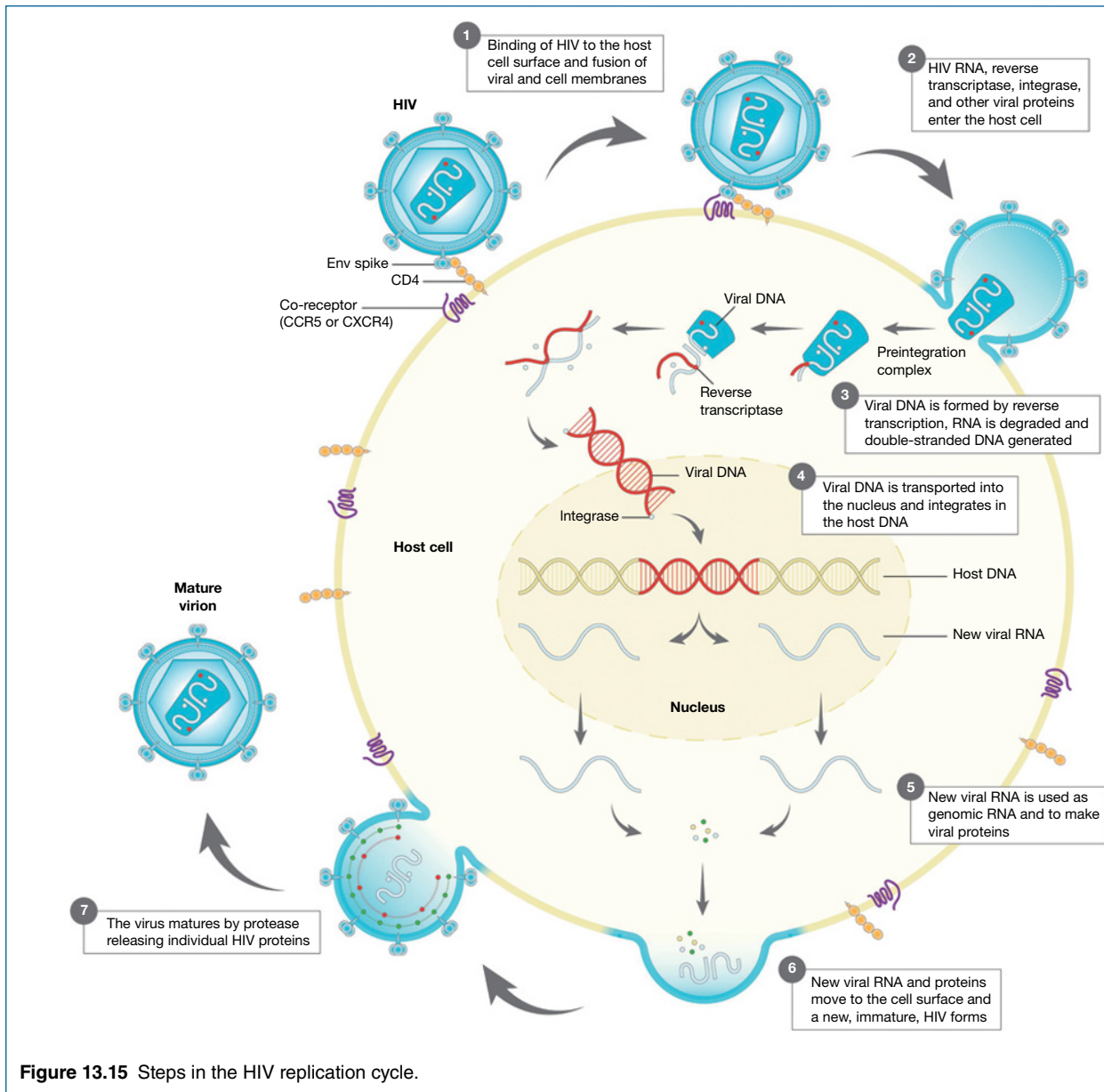


Figure 13.15 Steps in the HIV replication cycle.

The first receptor-specific binding event occurs when gp120 on the viral envelope spike engages CD4 on the target T-cell surface (Figure 13.15). HIV-1 specifically infects cells expressing CD4, including T-lymphocytes, macrophages, and dendritic cells. CD4 binds with high affinity to a recessed cavity of gp120 as revealed by a structure of gp120 in complex with CD4. This binding event triggers multiple conformational changes in gp120 that expose and form the co-receptor binding site. The co-receptor is most often the chemokine receptor CCR5 or CXCR4. These receptors normally function in chemoattraction, in which immune cells move along gradients of chemokine molecules to sites of inflammation. HIV-1s are often grouped by their co-receptor usage. R5 viruses use CCR5, X4 viruses use CXCR4, and dual tropic R5X4 viruses use both CCR5 and

CXCR4. R5 viruses only require low levels of CD4 expressed on the surface of target T-cells, whereas X4 viruses require higher levels. Thus, differential expression of CD4 and co-receptors makes different T-cell types (or subtypes) more susceptible to infection by either X4 or R5 viruses: X4 viruses infect naive CD4⁺ T-cells and mature DCs, whereas the preferred *in vivo* targets of R5 viruses include immature DCs, macrophages, and activated effector or memory CD4⁺ T-cells. Initially, R5 variants were labeled as “macrophage-tropic” when variants were classified based on the cell lines in which they could grow *in vitro* and, likewise, X4 viruses were labeled as “lymphocyte-tropic.” These former designations for HIV variants are misleading, as R5 viruses do infect lymphocytes, and therefore the designations were changed to reflect co-receptor usage.

Co-receptor binding induces conformational changes in the transmembrane glycoprotein gp41, which results in the exposure of the highly hydrophobic N-terminal fusion peptide of gp41, previously buried in the spike structure. The fusion peptide inserts into the host T-cell membrane like a harpoon, both destabilizing the target T-cell membrane and generating an extended α -helical gp41 fusion intermediate, designated the “pre-hairpin intermediate.” This intermediate is unstable and readily collapses back onto itself, forming a six-helix bundle, or “hairpin,” comprising three internal α -helices arranged antiparallel to three external α -helices. The collapse of gp41 into this extremely stable six-helical bundle is thought to provide the thermodynamic driving force for fusion. Six-helical bundles are a common structural motif among other viral and cellular fusion proteins; other viruses having surface proteins with structural similarities to gp41 include influenza virus, SARS, and Ebola virus. Although it is not well understood how six-helical bundle formation enables the merging of cellular and viral membranes, if bundle formation is prevented using peptide analogs that compete for the occupancy of the external α -helices, fusion is also abrogated. One such peptide was developed into an HIV drug, the first of a class of drugs referred to as viral entry inhibitors.

Fusion is a highly cooperative process that occurs on a time scale of minutes and has been proposed to require the interaction of one to several spikes with corresponding receptors and co-receptors to be an efficient process.

Following fusion, the virus particle has lost its enveloped exterior, and the viral core, or reverse transcription complex, remains. This complex is composed of two viral RNAs, RT, IN, tRNA^{Lys}, matrix (p17), nucleocapsid (p7), capsid protein (p24), and Vpr.

Reverse transcription and integration

En route to the nucleus, RT uses the two single-stranded RNA molecules enclosed within the viral core as a template to convert the viral genome into a double-stranded cDNA copy of the viral genome. RT has no proofreading mechanism and introduces between 0.1 and 1 mutations per genome replication. It has three activities: RNA-dependent DNA polymerase, ribonuclease H (RNase H), and DNA-dependent DNA polymerase activities. The RNase H activity degrades the RNA template as the minus strand DNA is synthesized by the RNA-dependent DNA polymerase activity and the DNA-dependent DNA polymerase activity catalyzes the generation of a double-stranded viral cDNA.

Upon reverse transcription, the complex contains essentially the same factors as before, except that the RNA genome has been replaced with a newly synthesized cDNA. This complex is referred to as the preintegration complex, and translocates to the nucleus, possibly via actin filaments and microtubules.

Integration of the viral cDNA into the host T-cell genome is mediated by integrase and the actions of several host proteins (Figure 13.15). It requires the viral LTR sequence and is preferentially targeted to areas of active transcription. Integration can lead to latent or transcriptionally active viral cDNA referred to as a provirus. Active provirus serves as the template for viral

replication and transcription. Latency explains the inability of viral therapies employed to date to eliminate virus completely from infected individuals and is the great challenge to a complete cure for HIV. The number of latently infected cells in an infected individual is very small, of the order of 10^6 .

Replication

Replication of the virus commences postintegration with the production of nascent viral transcripts by cellular RNA polymerases (Figure 13.15). Transcription is regulated by proteins that bind within the LTR sequences that flank the genome of the virus. For example, activation of T-cells results in the expression of transcription factor NF κ B. NF κ B binds to several promoters including those within the 5'-LTR.

Production of the viral proteins is biphasic. During the early phase (also called the Rev-independent phase), the viral transcripts are completely processed (i.e., all internal splice sites are utilized), polyadenylated, and exported to the cytoplasm as all other cellular transcripts. Translation of these transcripts results in three gene products: Tat, Rev, and Nef. Like other viruses, HIV-1 makes full use of a single template and therefore, in order for the other genes to be expressed, alternative splicing patterns are utilized (four different 5'-splice sites, eight different 3'-splice sites). A nuclear localization signal in the N-terminus of Rev guides it back to the nucleus post-translation with the help of cellular factor importin β . This arginine-rich domain also serves as a binding site for an RNA target, the Rev response element (RRE), which is located within the env intron of all incompletely spliced mRNAs. Splicing of HIV transcripts by cellular splicing factors is an inefficient process, and this allows time for Rev to bind the RRE. Rev cooperatively multimerizes along the RNA and this Rev-RRE complex associates with exportin/Crm-1 via a nuclear export signal in the C-terminus of Rev. This allows for efficient transport of the partially spliced or unspliced transcripts from the nucleus to the cytoplasm before the splicing factors are able to process the transcripts.

These actions by Rev permit the second phase of gene expression to commence and the partially spliced and unspliced mRNAs are translated into Env, Vif, Vpr, and Vpu and Gag and Gag-Pol, respectively. This is a crucial adaptation on the part of the virus as transcripts with introns are normally retained and degraded if they cannot be processed. Without Rev, HIV-1 is not able to transport its genetic material (containing multiple introns) to the cytoplasm where newly synthesized virus particles assemble; indeed, in experiments in which Rev is removed from the genome, the resulting virus clones are replication incompetent.

Tat and Nef are also crucial in HIV replication. In the absence of Tat, transcription begins but the polymerase fails to elongate efficiently along the viral genome. Tat binds to a well-defined structure at the 5'-end of the RNA, recruits positive elongation factors and promotes the rate of viral transcription. Nef acts differently to Tat and Rev; it does not bind directly to viral RNA but rather acts upon the environment of the infected

cell to favor replication. The activities of Nef include the ability to affect signaling cascades, downregulate CD4 expression at the infected cell surface and promote the generation of more infectious virions as well as virus dissemination. In addition by downregulating MHC class I molecules from the cell surface, Nef impairs adaptive immunological responses to HIV and inhibits apoptosis, thereby prolonging the life of the infected cell and increasing viral replication.

The number of mechanisms by which HIV promotes its own reproduction is staggering. It reflects the rapid turnover and inherent infidelity in HIV replication. The virus has sampled a huge number of different protein–protein and protein–nucleic acid interactions in its dance with humans and selection pressure has brought forth those interactions that favor virus survival and expansion. This is evolution on a time scale far shorter than normally experienced.

Virus assembly, budding, and maturation

New virus particle assembly occurs at the plasma membrane of the infected cell (Figure 13.15). One of the viral proteins translated in the cytosol during the late phase of gene expression is the Gag precursor protein p55. p55 trafficks to the plasma membrane and attaches to the lipid bilayer where it assembles into immature viral cores, and where Env glycoproteins are attached via the transmembrane anchor of gp41. Other structural viral proteins co-assemble at the cell membrane, specifically with two copies of the viral RNA genome, the Gag-Pol polyprotein, Vpr, Vif, and Nef. One of the key structural proteins present is p6, which connects the virus core to components of the endosomal sorting complex at sites of budding in the plasma membrane. Just before budding, other host factors, including cytoplasmic viral restriction factors such as APOBEC3G, can be incorporated into the virion. Coincident with budding of the immature virion from the plasma membrane, proteolytic processing of p55 and Gag-Pol occurs, generating the mature viral particle.

APOBEC3G is an interesting molecule that can restrict viral replication by cytidine deamination of DNA and resultant loss of functionality of viral genomes. The HIV-1 protein Vif binds to APOBEC3G and, by targeting it for proteasomal degradation, reduces its incorporation into virions. APOBEC3G is expressed in primary cells such as lymphocytes and macrophages and, as a consequence, Vif is essential for viral replication in these cells.

Another important HIV-1 restriction factor is TRIM5 α , which is responsible for the resistance of primate cells to diverse retrovirus infection. It targets the capsid protein and blocks an early step of retroviral infection prior to reverse transcription. However, the human protein is largely ineffective against HIV-1. Finally, although bone marrow stromal antigen 2 (BST2) or tetherin is a molecule that can suppress the effective release of budded virions from the surface of infected cells, Vpu counteracts its action by removing it from the site of budding at the cell surface.

In closing, it is important to note that much propagation of infection in HIV-1 *in vivo* probably occurs by cell-to-cell

spread of virus rather than by free virus particles. Env proteins on the infected cell surface engage receptors on neighboring target T-cells, but HIV-1 transfer still requires viral budding. It appears that HIV-1 particles transfer directionally through sites of contact between infected and uninfected T-cells in an arrangement that has been termed the virological synapse, with similarities to the immunological synapse found between T-cells and DCs. Nef promotes the formation of such synapses between infected macrophages and T-cells.

HIV-1 therapy

Great advances have been made in recent years in the containment of HIV replication in infected individuals and the slowing down or blocking of the progression to AIDS. Many new drugs are available. Many steps in the virus life cycle are potential targets for drugs, including: (i) entry; (ii) fusion; (iii) reverse transcription; (iv) integration; (v) transcription/transactivation; (vi) assembly; and (vii) maturation.

Currently, five classes of drugs targeting four steps are in clinical use. The first antiretroviral class to become available was the nucleoside/nucleotide reverse transcription inhibitors. These nucleoside/nucleotide analogs are incorporated into the growing strand of viral DNA leading to chain termination and the production of noninfectious virus. Reverse transcription can also be inhibited by a second class of drugs, the non-nucleoside/nucleotide reverse transcription inhibitors, which bind allosterically to a site distant from the substrate-binding site. Viral protease inhibitors inhibit cleavage of the Gag and Pol polyproteins. The first fusion inhibitor, enfuvirtide, was approved by the Federal Food and Drug Administration (FDA) in the United States in 2003, and is a peptide that binds to gp41 to inhibit fusion. The first integrase inhibitor was approved in the United States in 2007.

A major problem in HIV therapy is the development of drug resistance. The error-prone nature of reverse transcription, the large viral load, and the rapid rate of virus replication in many infected individuals means that they typically harbor a very large number of HIV variants. Administration of drugs may select for a variant that has resistance. Drug resistance against many protease inhibitors and some of the more potent nucleoside analogs can develop within a few days as a single mutation in the target enzyme confers resistance to many of these drugs. Resistance to other antiretrovirals, such as zidovudine (AZT), requires multiple mutations (three or four for AZT) and correspondingly longer to develop. As a result of the relatively rapid development of resistance to all HIV drugs used singly, successful suppression of HIV currently necessitates combination therapy. Antiretroviral therapy (ART) typically involves the administration of a combination of drugs operating by different mechanisms.

ART has proven very effective in the management of viral levels in infected individuals. During the first 2 weeks of treatment, plasma virus loads decrease very rapidly, reflecting the inhibition of virus production from infected cells and the rapid clearance of free virus from the circulation (half-life about

30 minutes). The results indicate that the half-life of productively infected cells is about 2 days. At the end of 2 weeks, viral plasma levels have decreased by more than 95%, signifying a nearly complete loss of productively infected CD4⁺ T-cells. There is a concomitant rise in CD4⁺ T-cell counts in the peripheral blood as HIV replication and infection is controlled. This rise has been attributed to three mechanisms: redistribution of CD4⁺ memory cells from lymphoid tissues into the circulation; reduction in the abnormal levels of immune activation associated with reduced CD8⁺ T-cell killing of infected cells; and the emergence of new naive T-cells from the thymus.

After the initial rapid and almost complete clearance of free virus, a second slow phase of viral decay reflects the very slow decay of virus production in longer lived reservoirs, such as in DCs and macrophages, from latently infected memory CD4⁺ T-cells that have been activated. A third phase has been postulated, which is even slower, resulting from reactivation of integrated provirus in memory T-cells and other long-lived reservoirs of infection. Follicular DCs store virus in the form of immune complexes, making them potential long-term sources of infectious virus. These latent reservoirs may persist for years and are resistant to current HIV drug therapy.

Considerable interest in recent years has centered on the use of antiretroviral drugs in the prevention of HIV infection or pre-exposure prophylaxis (PrEP). Clinical studies have shown that oral administration of the drug tenofovir or a combination of the drugs tenofovir and emtricitabine (Truvada) given daily can greatly reduce infections among individuals at high risk of becoming infected. The US Centers for Disease Control and Prevention added Truvada for PrEP to its guidelines for HIV prevention in 2014.

HIV-1 vaccines

Most epidemiologists agree that the most efficient means to control the HIV-1 pandemic would be an effective vaccine. Unfortunately, the development of such a vaccine faces some major hurdles intimately associated with features of the virus. These include the variability of the virus, the nature of the envelope spikes of the virus, and the ability of the virus to integrate into host chromosomes and become latent.

Most viral vaccines appear to be effective because they mimic natural infection and elicit neutralizing antibody responses. Long-lived plasma cells in the bone marrow secrete neutralizing antibodies that are present in serum and can act immediately to inactivate virus particles (Figure 13.16). Indeed, the likelihood that a vaccine will be effective is often assessed by looking at serum neutralizing antibody levels. Additionally, on contact with virus, vaccine-induced memory B-cells are stimulated to secrete neutralizing antibodies. Studies in monkeys show that neutralizing antibodies can protect against HIV. If neutralizing antibodies are administered systemically and then the monkeys challenged with a hybrid human (HIV)/monkey (SIV) virus, they show no signs of infection (i.e., they exhibit sterilizing immunity). However, there is a requirement that the neutralizing antibodies elicited by vaccination be active against a wide spectrum of different HIV variants (so-called broadly neutralizing antibodies). Such antibodies are known to exist but the design of immunogens to elicit them has not yet been achieved. Indeed, natural HIV infection elicits potent broadly neutralizing antibody responses infrequently, highlighting the difficulties of finding an appropriate immunogen. Natural

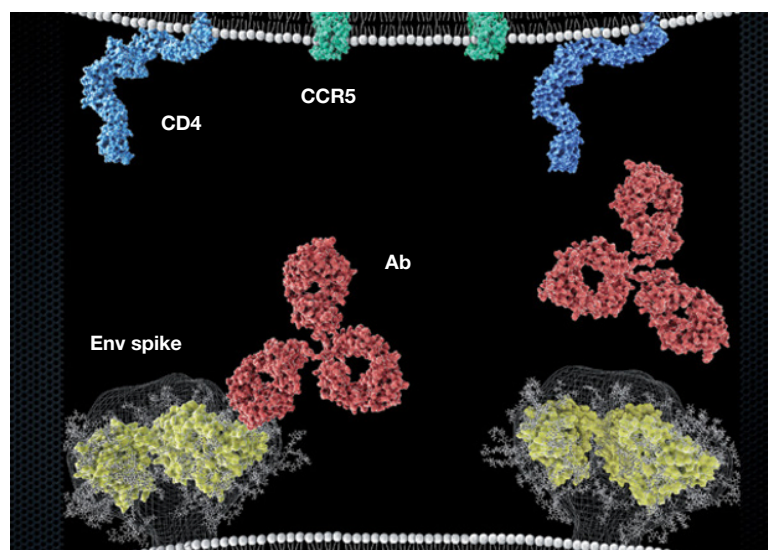


Figure 13.16 Model for neutralization of HIV by antibody. Viral entry is mediated by the interaction of envelope spikes on the virus surface with CD4 and CCR5 on the target cell surface. The antibody molecule (Ab) has a molecular volume approaching that of a spike. Therefore the attachment of an antibody molecule to a spike is expected to show strong steric interference with virus attachment and/or fusion. Further, some antibodies appear able to inactivate spikes by inducing conformational rearrangements. (Adapted from Pognard *et al.* (2001) *Annual Review of Immunology*, **19**, 253–274; and Schief *et al.* (2010) *Current Opinion in HIV and AIDS* **4**, 431–440.)

infection tends to elicit type-specific neutralizing antibodies (Figure 13.17). When these antibodies reach a critical threshold, a resistant virus emerges. Eventually, a neutralizing antibody response to this virus develops and a new resistant virus emerges and so on. Apparently the virus always stays one step ahead of the neutralizing antibody response.

It appears that it will be challenging to design an HIV vaccine that will provide sterilizing immunity through elicitation of broadly neutralizing antibodies. In fact, most current vaccines effective against other viruses are not thought to provide sterilizing immunity. Rather they elicit sufficient serum titers of neutralizing antibody to blunt infection, which is then contained by cellular or innate immunity and overt symptoms are avoided. In other words, vaccination protects against disease rather than infection. The difficulties of eliciting broadly neutralizing antibodies can be ascribed to the nature of the HIV envelope spike (Figure 13.18), which is a meta-stable structure, densely coated with glycans and prominently presenting immunodominant variable regions.

Studies in animal models have shown that protection against disease for a number of viruses can be achieved by eliciting a cellular immune response through vaccination. In the absence of effective methods to elicit broadly neutralizing antibodies, much HIV vaccine research has targeted cellular immune responses. The primary rationale has been that if potent T-cellular immune responses can be elicited in vaccinees, the response may reduce the damage to CD4⁺ T-cells following primary infection and lower the viral set point. As viral set point has been correlated with time of progression to AIDS, this would provide direct benefit to

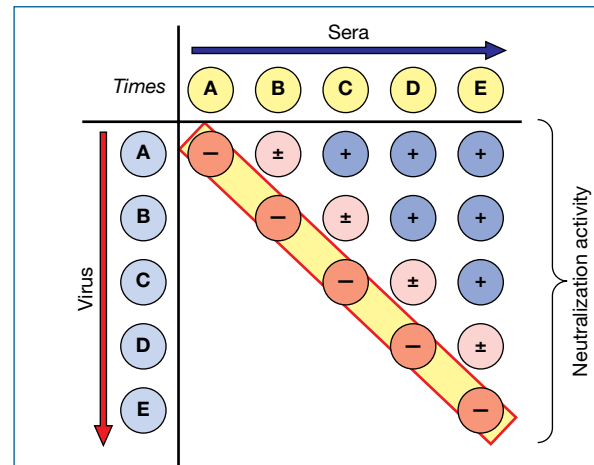


Figure 13.17 Evolution of the neutralizing antibody response in HIV infection. A–E refer to virus and sera from time points A–E during the course of infection of an individual. Serum taken at time point A has no significant neutralizing activity against virus isolated from the plasma of the infected individual at time point A. Serum taken at time point B has some weak activity. Serum taken at time point C and points thereafter clearly neutralizes virus from time point A. Once the serum neutralizing antibody concentration has reached a certain threshold following exposure to a given predominant virus variant, selection pressure is exerted such that a new neutralization-resistant variant emerges from the huge pool of variants present in the infected individual. A neutralizing antibody response develops to this new variant and the cycle is repeated. (Source: Richman D.D. *et al.* (2003) *Proceedings of the National Academy of Sciences of the USA* **100**, 4144–4149. Reproduced with permission of the National Academy of Sciences.)

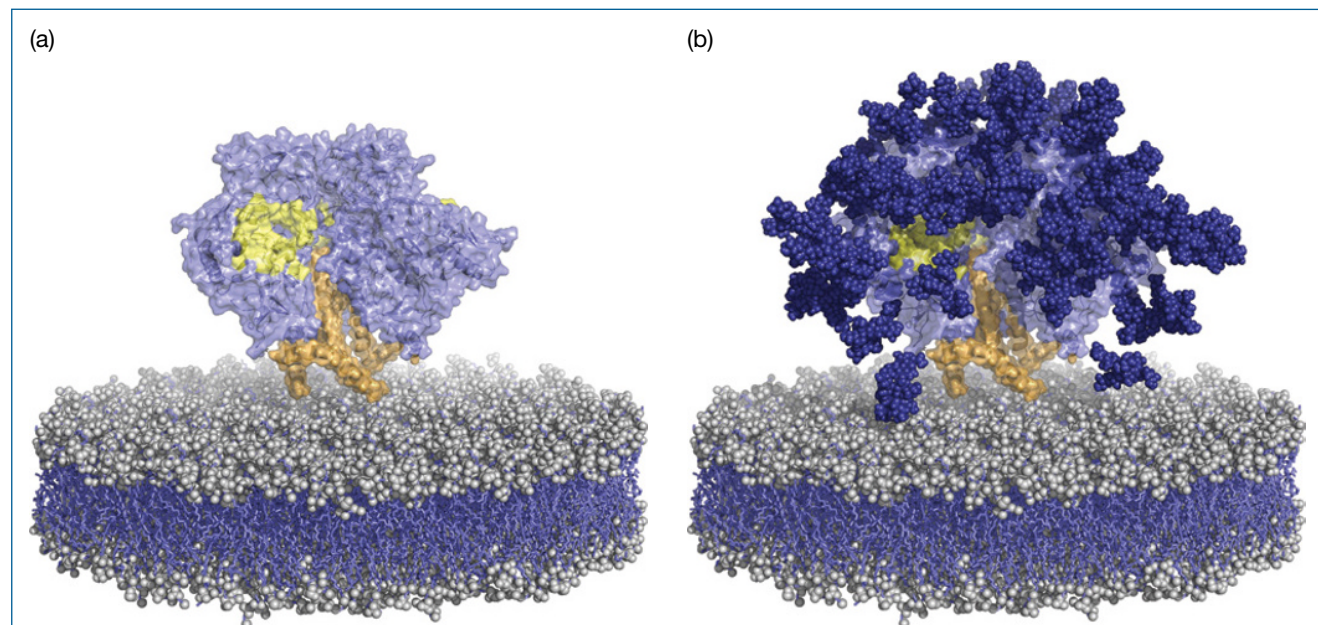


Figure 13.18 Structure of the HIV envelope spike. The envelope spike of composition $(gp120)_3(gp41)_3$ is represented at the viral membrane bilayer. The structure of a molecule largely constituting the external part of the trimer has been determined by crystallography and cryoelectron microscopy. On the virus, transmembrane segments and a cytoplasmic domain will hold the trimer on the surface. (a) The three gp41 molecules are shown in brown, the three tightly packed gp120 molecules in light purple, and the CD4 binding site in yellow. (b) The trimer now includes the glycan chains (dark blue) that cover much of the spike surface making antibody access difficult. (Source: Joe Jardine and Christina Corbaci.)

vaccines. Furthermore, reduction of average plasma viral loads in vaccinated individuals should reduce transmission rates since transmission correlates with plasma viral load. Thus, vaccination should provide benefit to the population at large. Finally, reducing the damage to CD4⁺ T-cells in primary infection may help to maintain immunity against many pathogens over a long period.

Most studies on so-called “T-cell vaccines” have been carried out in monkeys. The results have been mixed. The best CD8⁺ T-cell responses, at least in terms of ELISPOT measurements, have been achieved using recombinant viral vectors to express HIV/SIV gene products. In particular, adenovirus vectors, either alone or in combination with other vectors or DNA vaccination, have elicited significant T-cellular responses. These responses have shown some protection in some monkey models but not in others.

Five larger scale human HIV vaccine trials have been carried out. Two trials reporting in 2003 were based on recombinant monomeric gp120 and could be described as “antibody vaccines,” in that they were expected to elicit primarily antibody responses. However the responses did not neutralize typical

HIV isolates and the vaccines showed no efficacy. A trial reporting in 2007 was based on an adenovirus vector encoding HIV internal proteins Gag, Pol, and Nef and was described as a “T-cell vaccine.” The vaccine showed no efficacy. Initially, it was thought that the vaccine had enhanced infection rates but detailed studies have brought this interpretation into question. A trial reporting in 2009 was based on a canarypox vector encoding HIV Gag, Pro, and Env with boosting by Env (recombinant gp120). This has been described as an “antibody and T-cell vaccine.” The trial described possible modest efficacy close to the limits of statistical significance that appeared to have very short duration. Finally in 2013, another vaccine trial involving a DNA prime (Gag, Pol, Nef, Env) and adenovirus boost (Gag, Pol, Env) reported no efficacy.

Overall, it is clear that the development of an HIV vaccine is one of the major challenges facing modern medicine. Many believe that success will require the development of immunogens that can elicit both potent broadly neutralizing antibody and cellular immune responses.

Primary immunodeficiency diseases (PIDs)

- Primary immunodeficiencies are much less common than secondary, occur as a result of a gene defect, and can affect almost any component of the immune response.
- They are characterized by opportunistic infections.
- Several X-linked mutations produce PIDs in males.
- PIDs illuminate the importance of individual components of the immune system in combating particular infectious agents.
- Treatment includes prophylactic antibiotics, intravenous Ig, hematopoietic stem cell transplantation, and, potentially, gene therapy.

PIDs affecting innate responses

- Mutations in the genes encoding pattern recognition receptors or their associated adaptor and signaling molecules will particularly affect innate responses.
- Phagocytic cell or complement defects result in infection with bacteria that would normally be disposed of by opsonization and phagocytosis.
- Where there is an inability to produce the membrane attack complex there is only a very limited spectrum of increased infections, mainly with *Neisseria* spp.
- Defects in complement components are associated with age-related macular degeneration or immune-complex-mediated autoimmune disease.
- A mutation in any one of several genes involved in the IFN γ response leads to increased susceptibility to mycobacterial infections.
- Mutations that influence IL-1 β or TNF pathways can lead to autoinflammatory conditions in which inflammation occurs in the absence of a stimulus.

B-cell primary immunodeficiencies

- Selective IgA deficiency is the most common PID but affected individuals are often symptomless.
- In X-linked agammaglobulinemia all classes of antibodies are absent or only present at extremely low concentrations because of a defect in the Bruton's tyrosine kinase resulting in maturation arrest at the pre-B-cell stage.
- Common variable immunodeficiency is associated with low IgG and IgA and/or IgM.

T-cell primary immunodeficiencies

- Patients with T-cell deficiencies are susceptible to intracellular bacteria, viruses, and fungi.
- A lack of functional T-cells will impair B-cell responses.
- In complete DiGeorge syndrome the absence of a thymus leads to an inability to produce T-cells, although in most cases there is only a partial defect.
- Mutations affecting the enzyme purine nucleoside phosphorylase lead to the accumulation of toxic metabolites that particularly affect T-cells.
- The genes linked to Omenn syndrome are similar to those responsible for SCID but the site of the actual mutation is different and does not have quite such a profound effect.
- An absence of either MHC class I or class II molecules will result in the inability of T-cells to undergo positive selection in the thymus.
- A number of gene defects, including those associated with Wiskott–Aldrich syndrome and with hyper-IgM syndrome, adversely affect the ability of T-cells to interact with B-lymphocytes.
- Mutations in genes required for regulatory T-cell activity result in autoimmune conditions.

Severe combined immunodeficiency

- Null mutations in a number of different genes, including γ_c , ADA, RAG-1, RAG-2, JAK-3, Artemis, and the IL-7R α chain, can result in SCID.
- There is a complete block in the development of T-cells, and thus complete lack of help for B-cells. Depending on the particular gene defect, B-cells and/or NK cells may also be absent.
- Most cases of gene therapy for PIDs have attempted to insert a normal gene for ADA or γ_c .

Secondary immunodeficiency

- Immunodeficiency may arise as a secondary consequence of malnutrition, lymphoproliferative disorders, agents such as X-rays and cytotoxic drugs, and viral infections.

Acquired immunodeficiency syndrome (AIDS)

- AIDS results from infection with the lentiviruses HIV-1 or HIV-2, with HIV-1 being much more prevalent worldwide.
- HIV-1 infects CD4⁺ cells, including CD4⁺ T-cells, macrophages, and dendritic cells.
- Depletion of CD4⁺ T-cells, dramatically in primary infection particularly in the gut and then more slowly over a period of years during clinical latency, leads to damage to the immune system, which renders an individual susceptible to opportunistic pathogens (AIDS).
- HIV-1 is a retrovirus, which gains entry to cells by interaction of envelope spikes with CD4 and the chemokine receptors

CCR5 or CXCR4. The RNA genome is reverse transcribed and the resulting viral cDNA integrated into host T-cell chromosomes.

- Integrated proviral DNA can remain latent in cells for very long times, posing enormous problems for complete elimination of the virus from an individual and therefore hampering a complete cure for HIV-1 infection.
- Proviral DNA can be transcribed to generate new viral particles with the aid of several viral accessory proteins, which act to aid viral replication and/or adapt the host T-cell machinery to virus production.
- A major hallmark of HIV is the enormous diversity of the virus, present even in a single infected individual, because of the inherent errors involved in transcribing from an RNA genome, the rapid turnover of the virus and the high viral burden typically carried by the individual.
- Viral diversity and latency present major challenges to drug therapy but nevertheless drug design has been highly successful and combination drug regimes can hold the virus in check for many years, if not indefinitely.
- Vaccine design has also struggled with viral diversity and no immunogens that elicit broadly neutralizing antibodies or sufficiently potent T-cell responses to significantly contain challenge with a wide diversity of HIVs have yet been designed, although efforts are intense and there are promising leads.



Now visit www.roitt.com to test yourself on this chapter.

FURTHER READING

- Arhel N. and Kirchhoff F. (2010) Host proteins involved in HIV infection: new therapeutic targets. *Biochimica et Biophysica Acta* **1802**, 313–321.
- Badolato R. (2013) Defects of leukocyte migration in primary immunodeficiencies. *European Journal of Immunology* **43**, 1436–1440.
- Barouch D.H. and Deeks S.G. (2014) Immunologic strategies for HIV-1 remission and eradication. *Science* **345**, 169–174.
- Broder S. (2010) The development of antiretroviral therapy and its impact on the HIV-1/AIDS pandemic. *Antiviral Research* **85**, 1–18.
- Burton D.R., Poignard P., Stanfield R.L., and Wilson, I.A. (2012). Broadly neutralizing antibodies present new prospects to counter highly antigenically diverse viruses. *Science* **337**, 183–186.
- de Jesus A.A., Canna S.W., Liu Y. and Goldbach-Mansky R. (2015) Molecular mechanisms in genetically defined autoinflammatory diseases: disorders of amplified danger signaling. *Annual Review of Immunology* **33**, 823–874.
- Durandy A., Kracker S., and Fischer A. (2013) Primary antibody deficiencies. *Nature Reviews Immunology* **13**, 519–533.
- Fauci A.S. and Marston H.D. (2014) Ending AIDS – is an HIV vaccine necessary? *New England Journal of Medicine* **370**, 495–498.
- Fischer A., Haccin-Bey-Abina S., and Cavazzana-Calvo M. (2013) Gene therapy of primary T cell immunodeficiencies. *Gene* **525**, 170–173.
- Fodil N., Langlais D., and Gros P. (2016) Primary Immunodeficiencies and Inflammatory Disease: A Growing Genetic Intersection. *Trends in Immunology* **37**, 126–140.
- Greene W.C. and Peterlin B.M. (2002) Charting HIV's remarkable voyage through the cell: basic science as a passport to future therapy. *Nature Medicine* **8**, 673–680.
- Klasse P.J., Shattock R., and Moore J.P. (2008) Antiretroviral drug-based microbicides to prevent HIV-1 sexual transmission. *Annual Review of Medicine* **59**, 455–471.
- Kohn D.B. (2010) Update on gene therapy for immunodeficiencies. *Clinical Immunology* **135**, 247–254.
- Malim M.H. and Bieniasz P.D. (2012) HIV restriction factors and mechanisms of evasion. *Cold Spring Harbor Perspectives in Medicine* **2**, a006940.

- Malim M.H. and Emerman M. (2008) HIV-1 accessory proteins – ensuring viral survival in a hostile environment. *Cell Host & Microbe* **3**, 388–398.
- McMichael A.J., Borrow P., Tomaras G.D., Goonetilleke N., and Haynes B.F. (2010) The immune response during acute HIV-1 infection: clues for vaccine development. *Nature Reviews Immunology* **10**, 11–23.
- Milner J.D. and Holland S.M. (2013) The cup runneth over: lessons from the ever-expanding pool of primary immunodeficiency diseases. *Nature Reviews Immunology* **13**, 635–648.
- Mukherjee S. and Thrasher A.J. (2013) Gene therapy for PIDs: progress, pitfalls and prospects. *Gene* **525**, 174–181.
- Ochs H.D., Smith C.I.E., and Puck J.M. (eds.) (2013) *Primary Immunodeficiency Diseases – A Molecular and Genetic Approach*, 3rd edn. Oxford University Press, Oxford.
- Orange J.S. (2013) Natural killer cell deficiency. *Journal of Allergy and Clinical Immunology* **132**, 515–525.
- Picard C., Al-Herz W., Bousfiha A. *et al.* (2015) Primary Immunodeficiency Diseases: an Update on the Classification from the International Union of Immunological Societies Expert Committee for Primary Immunodeficiency 2015. *Journal of Clinical Immunology* **35**, 696–726.
- Richman D.D., Margolis D.M., Delaney M., Greene W.C., Hazuda D., and Pomerantz R.J. (2009) The challenge of finding a cure for HIV infection. *Science* **323**, 1304–1307.
- Sharp P.M. and Hahn B.H. (2008) AIDS: prehistory of HIV-1. *Nature* **455**, 605–606.
- Siliciano R.F. and Greene W.C. (2011) HIV latency. *Cold Spring Harbor Perspectives in Medicine* **1**, a007096.
- Skattum L., van Deuren M., van der Poll T., and Truedsson L. (2011) Complement deficiency states and associated infections. *Molecular Immunology* **48**, 1643–1655.
- Tilton J.C. and Doms R.W. (2010) Entry inhibitors in the treatment of HIV-1 infection. *Antiviral Research* **85**, 91–100.
- Walker B.D. and Yu X.G. (2013) Unravelling the mechanisms of durable control of HIV-1. *Nature Reviews in Immunology* **13**, 487–498.

CHAPTER 14

Allergy and other hypersensitivities

Key topics

- Type I hypersensitivity – IgE-mediated mast cell degranulation 407
- Type II hypersensitivity – antibody-dependent cytotoxicity 418
- Type III hypersensitivity – immune complex-mediated 421
- Type IV hypersensitivity – cell-mediated (delayed-type) 426
- An addition to the original classification – stimulatory hypersensitivity (“type V”) 430
- Innate hypersensitivity reactions 430

Roitt's Essential Immunology, Thirteenth Edition. Peter J. Delves, Seamus J. Martin, Dennis R. Burton, and Ivan M. Roitt.
 © 2017 John Wiley & Sons, Ltd. Published 2017 by John Wiley & Sons, Ltd.
 Companion website: www.roitt.com

Just to recap ...

Infections are dealt with by appropriate immune responses that detect foreign antigens. In the case of adaptive responses there is a necessity for clonal proliferation of lymphocytes in order to generate sufficient numbers of antigen-specific cells. Antibody of a class appropriate to clear the infection is produced and binds to the surface of the pathogen. The formation of IgM- or IgG-containing immune complexes triggers the activation of the classical complement pathway. IgG and complement components opsonize microorganisms for subsequent phagocytosis. In the case of parasitic infections, Th2-derived IL-4 and IL-13 encourage IgE production by B-cells. Intracellular pathogens are dealt with by NK cells, cytotoxic T-cells, and Th1 cells producing macrophage-activating factors such as IFN γ .

Introduction

In *allergy* the immune response extends beyond its usual boundary of recognizing only foreign pathogens to also encompass what should be innocuous environmental antigens.

This is a form of *hypersensitivity*, overzealous immunity that can also take the form of reactivity to self antigens or to antigens from another species. Indeed, in the past autoimmune responses were often referred to as autoallergic responses. Hypersensitivity responses lead to tissue damage: *immunopathology*. It should be emphasized that the mechanisms underlying hypersensitivity reactions are the same as those normally employed by the body in combating infection, the problem is that they are occurring with much too high an intensity, are directed against antigens that pose no threat and/or are taking place at locations in the body that are inappropriate. The various hypersensitivity states were originally classified into types I–IV (Figure 14.1a–d) by Gell and Coombs and this classification remains broadly useful. Most allergies (hayfever, asthma, eczema, and food allergies) are mediated by type I hypersensitivity reactions, although some forms of eczema are due to type IV reactions. Some subsequent additions to the original classification have included a type V and an innate hypersensitivity (Figure 14.1e–f). It should also be noted that in a particular disease state more than one type of hypersensitivity may be operating.

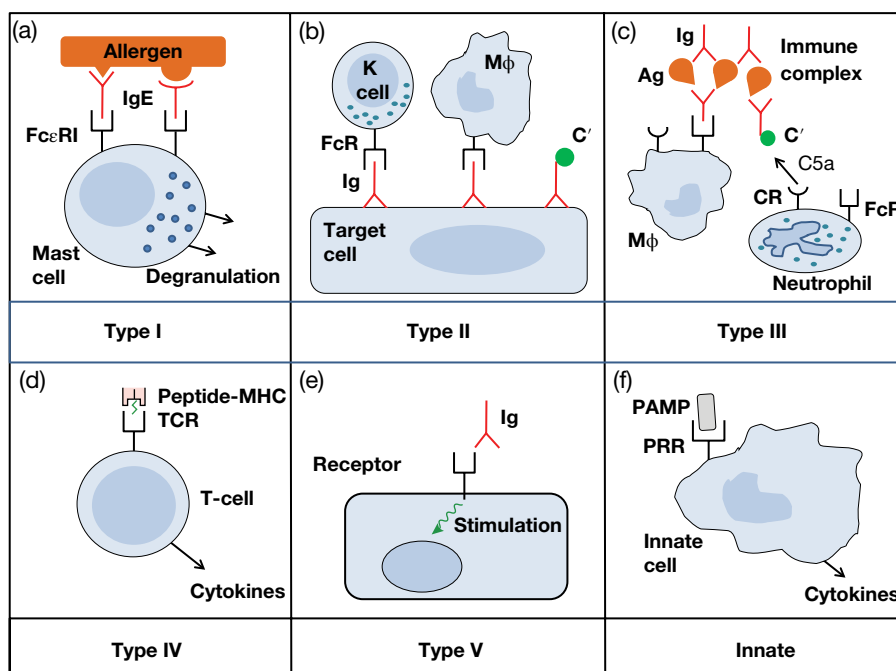


Figure 14.1 Six categories of hypersensitivity. Type I: IgE-mediated mast cell degranulation. Type II: antibody-dependent cytotoxicity which can be mediated by killer (K) cells carrying out antibody-dependent cellular cytotoxicity (ADCC), by opsonization for phagocytosis, or by activation of the classical pathway of complement with the generation of the membrane attack complex. Type III: immune complex-mediated which can result in activation of phagocytic cells leading to an inflammatory response (as well as platelet aggregation and mast cell activation, not shown). Type IV: delayed type (cell-mediated) involving the release of cytokines from T-cells. Type V: stimulatory hypersensitivity in which antibodies act as agonists for cell surface receptors. Innate hypersensitivity resulting from, for example, excessive activation of pattern recognition receptors (PRR). Ag, antigen; C', complement; CR, complement receptor; FcεR1, high-affinity IgE receptor; FcR, Fc receptor for antibody of appropriate class; Ig, immunoglobulin; Mφ, macrophage; MHC, major histocompatibility complex; PAMP, pathogen-associated molecular pattern; TCR, T-cell receptor.



Type I hypersensitivity – IgE-mediated mast cell degranulation

Anaphylaxis

The earliest accounts of inappropriate responses to foreign antigens relate to *anaphylaxis* (Milestone 14.1). This phenomenon is characterized by intense constriction of the bronchioles and bronchi, contraction of smooth muscle, and dilatation of capillaries. Life-threatening anaphylactic responses can occur in individuals that are highly allergic to insect stings, pollens, foods, drugs such as penicillin, or other agents. In many instances only a timely injection of epinephrine, which rapidly reverses the action of histamine on smooth muscle contraction and capillary dilatation, can prevent death. Individuals known to be at risk are given preloaded epinephrine syringes for self-administration.

Sir Henry Dale recognized that histamine mimics the systemic changes of anaphylaxis and, furthermore, that exposure of the uterus from a sensitized guinea-pig to antigen induces an immediate contraction associated with an explosive degranulation of mast cells responsible for the release of histamine and a number of other mediators of anaphylaxis (see Figure 1.14).

Mast cells

In rodents, two main types of *mast cell* have been recognized: those in the intestinal mucosa and those in the peritoneum and other connective tissue sites. They differ in a number of respects, for example in the type of protease and proteoglycan in their granules, and in their ability to proliferate and differentiate in response to stimulation by interleukin 3 (IL-3) (Table 14.1). The two types have common precursors and are

interconvertible depending upon the environmental conditions, with the mucosal MC_t (tryptase) phenotype favored by IL-3 and connective tissue MC_c (both tryptase and chymase) being promoted by relatively high levels of stem cell factor (c-kit ligand). In humans, most mast cells in the intestinal mucosa and lung alveoli are tryptase-only positive, whereas those in skin, intestinal submucosa, and other connective tissues are tryptase, chymase, and carboxypeptidase positive. A third, less frequent, population is chymase-only positive and is found in the nasal mucosa and intestinal submucosa.

Cross-linking of IgE receptors on mast cells triggers degranulation

Mast cells, and their circulating counterpart the basophil, abundantly display the $Fc\epsilon RI$ high-affinity ($K_a 10^{10} M^{-1}$) receptor for IgE (see Table 3.2). The receptor is also expressed, albeit at considerably lower levels, on Langerhans cells, dendritic cells, monocytes, macrophages, neutrophils, eosinophils, platelets, and the intestinal epithelium. On basophils and mast cells the receptor is a tetramer consisting of an α chain, a tetraspan β chain and two disulfide-linked γ chains, whereas on other cell types, where the receptor is involved in antigen presentation rather than triggering degranulation, the β chain is absent and therefore the receptor is a trimer. The α chain possesses two external Ig-type domains responsible for binding the C $\epsilon 3$ region of IgE (Figure 14.2), whereas the γ chains and β chain each contain a cytoplasmic immunoreceptor tyrosine-based activation motif (ITAM) for cell signaling. In the absence of bound IgE the level of $Fc\epsilon RI$ drops substantially. However, in its presence there is upregulation of the receptor on mast cells and, because the γ chain is shared with the mast cell $Fc\gamma RIIIA$,



Milestone 14.1 The discovery of anaphylaxis

Hypersensitive reactions in some individuals to normally innocuous environmental agents have been observed from time immemorial. Scientific interest in such reactions was aroused by the observations of Charles Richet and Paul Portier. During a South Sea cruise on Prince Albert of Monaco's yacht, the Prince, presumably smarting from an encounter with *Physalia* (the jellyfish known as the Portuguese man-of-war with very nasty tentacles), suggested that toxin production by the jellyfish might be of interest. Let Richet and Portier take up the story in their own words (1902):

“On board the Prince's yacht, experiments were carried out proving that an aqueous glycerin extract of the filaments of *Physalia* is extremely toxic to ducks and rabbits. On returning to France, I could not obtain *Physalia* and decided to study comparatively the tentacles of *Actiniaria* (sea anemone). While endeavouring to determine the toxic dose (of extracts), we soon discovered that some days must elapse before fixing it; for

several dogs did not die until the fourth or fifth day after administration or even later. We kept those that had been given insufficient to kill, in order to carry out a second investigation upon these when they had recovered. At this point an unforeseen event occurred. The dogs that had recovered were intensely sensitive and died a few minutes after the administration of small doses. The most typical experiment, the one in which the result was indisputable, was carried out on a particularly healthy dog. It was given at first 0.1 ml of the glycerin extract without becoming ill: 22 days later, as it was in perfect health, I gave it a second injection of the same amount. In a few seconds it was extremely ill; breathing became distressful; it could scarcely drag itself along, lay on its side, was seized with diarrhea, vomited blood and died in 25 minutes.”

The development of sensitivity to relatively harmless substances was termed by these authors *anaphylaxis*, in contrast to *prophylaxis*.

Table 14.1 Comparison of the two main types of mast cell.

Characteristics	Mucosal mast cell	Connective tissue mast cell
<i>General</i>		
Abbreviation*	MC _t	MC _{tc}
Distribution	Gut & lung	Most tissues**
Differentiation favored by	IL-3	Stem cell factor
Activity is T-cell dependent	+	-
High-affinity Fcε receptor	2 × 10 ⁵ /cell	3 × 10 ⁴ /cell
<i>Granules</i>		
Alcian blue and Safranin staining	Blue & brown	Blue
Ultrastructure	Scrolls	Gratings/lattices
Protease	Tryptase	Tryptase & chymase
Proteoglycan	Chondroitin sulfate	Heparin
<i>Degranulation</i>		
Histamine release	+	++
LTC ₄ : PGD ₂ release	25 : 1	1 : 40
Blocked by disodium cromoglycate/theophylline	-	+
*Based on protease in granules.		
**Predominate in normal skin and intestinal submucosa.		

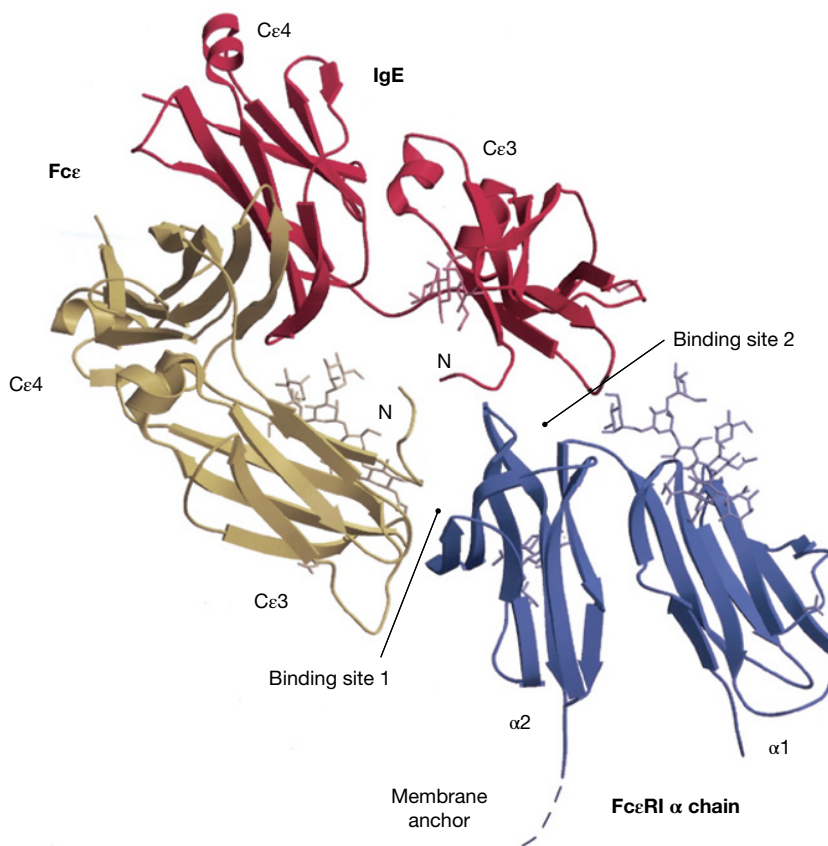


Figure 14.2 The structural basis of the binding of IgE to the high-affinity mast cell receptor FcεRI. Side view of the complex with the two Fc chains in yellow and red and the FcεRI α chain in blue; carbohydrate residues are shown as sticks. The two Cε3 domains of the heavy chain dimer of IgE bind asymmetrically to two distinct interaction sites on the α chain of the receptor. The β-turn loop on one Cε3 binds along one side of the α2 domain, while surface loops plus the Cε2–Cε3 linker region on the other Cε3 interact with the top of the α1–α2 interface. The 1 : 1 stoichiometry of this asymmetric binding precludes the linkage of one IgE to two receptor molecules and ensures that triggering owing to α–α aggregation only occurs through multivalent binding to surface IgE (see Figure 14.3). (Source: Ted Jardetzky. Reproduced with permission.)

a consequent competitive downregulation of the Fc receptor for IgG. Anaphylaxis is mediated by the reaction of the allergen with the IgE antibodies held on the surface of the mast cell. Cross-linking of these antibodies by allergen causes cross-linking of the receptors to which the antibodies are bound. This results in intracellular signaling that triggers degranulation and the release of inflammatory mediators (Figure 14.1a). Note that, as illustrated in this figure, the two antibodies can be against different epitopes on the same allergen, and that anti-allergen antibodies will need to be represented on the mast cell surface at a reasonably high frequency in order for efficient cross-linking to occur. That the critical event is aggregation of the receptors by cross-linking is clearly shown by the ability of divalent anti-receptor antibodies to trigger the mast cell.

Aggregation of the FcεRI α chains activates the Lyn and Fyn protein tyrosine kinases associated with the β chains and, if the aggregates persist, this leads to transphosphorylation of the β and γ chains of other FcεRI receptors within the cluster and recruitment of the Syk kinase (Figure 14.3). The subsequent series of phosphorylation-induced activation steps ultimately leads to mast cell degranulation with release of preformed mediators and the synthesis of arachidonic acid metabolites formed by the cyclo-oxygenase and lipoxygenase pathways (see Figure 1.14). The preformed mediators released from the granules include histamine, heparin, tryptase, chymase, carboxypeptidase, eosinophil, neutrophil and monocyte chemotactic factors, platelet activating factor, and serotonin. By contrast, leukotrienes LTB₄, LTC₄, and LTD₄,

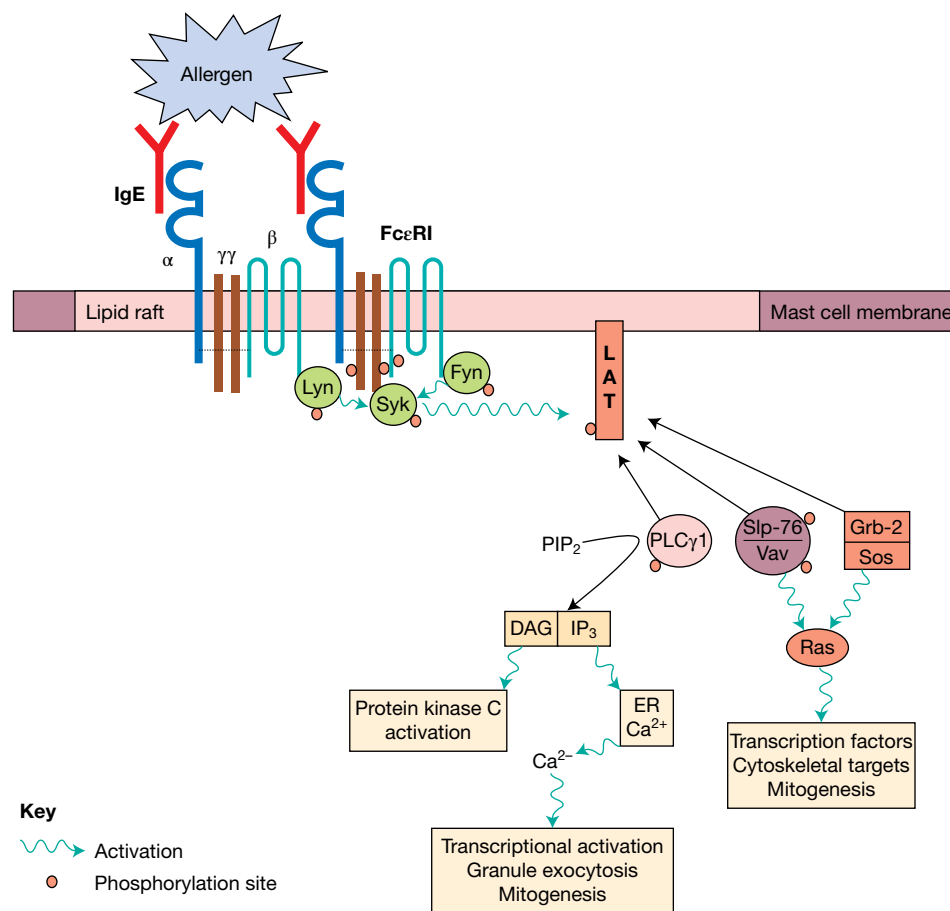


Figure 14.3 Mast cell triggering. Cross-linking of the high-affinity IgE receptor FcεRI by binding of multivalent allergen to IgE leads to mast cell degranulation. A simplified scheme is shown of some of the signaling events that occur. Aggregation of the FcεRI α chains in lipid rafts leads to ITAMs in the β and γ chains of the receptor interacting with the Lyn, Syk, and Fyn protein tyrosine kinases. Phosphorylation of Syk leads to its activation and it in turn phosphorylates and activates the membrane adaptor LAT1 and LAT2 (NTAL) proteins that recruit phospholipase Cγ1 (PLCγ1) and adaptor molecules concerned in the activation of GTPase/kinase cascades. Activation of PLCγ1 generates diacylglycerol (DAG) that targets protein kinase C, while inositol 1,4,5-triphosphate (IP₃) elevates cytoplasmic Ca²⁺ by depleting the ER stores. The raised calcium concentration activates transcriptional factors and causes granule exocytosis. The Grb-2/Sos and Slp-76/Vav complexes associate with the LAT1 adaptor, and Grb-2/Sos additionally with LAT2, and trigger the Ras GTPase-induced serial kinase cascade leading to the activation of transcription factors and rearrangements of the actin cytoskeleton. (Source: Turner H. and Kinet J.-P. (1999) *Nature (Supplement on Allergy and Asthma)* **402**, B24. Reproduced with permission of Nature Publishing Group.)

the prostaglandin PGD_2 , and thromboxanes are all newly synthesized. The Th2-type cytokines IL-4, IL-5, IL-6, IL-9, IL-10, IL-13, as well as IL-1, IL-3, IL-8, IL-11, granulocyte-macrophage colony-stimulating factor (GM-CSF), TNF (tumor necrosis factor), CCL2 (monocyte chemotactic protein-1 [MCP-1]), CCL5 (RANTES), and CCL11 (eotaxin), are all also released. Under normal circumstances, these mediators help to orchestrate the development of a defensive acute inflammatory reaction (and in this context let us not forget that complement fragments C3a and C5a can also trigger mast cells through complement receptors). When there is a massive release of these mediators under abnormal conditions, as in type I hypersensitivity, their bronchoconstrictive and vasodilatory effects become distinctly threatening.

Atopic allergy

The term *atopy* (from the Greek *atopos*, meaning “out of place”) refers to the generation of inappropriate levels of IgE against external allergens. Clinically, type I hypersensitivity can manifest itself as *immunological reactions in the gastrointestinal tract, eczema* (atopic dermatitis), *asthma, and/or hayfever* (seasonal allergic conjunctivitis and rhinitis). These conditions often occur in the same individual; indeed in many subjects they develop in an ordered sequence that has been referred to as the “allergy march” (Figure 14.4). Thus infants and children with gastrointestinal and cutaneous allergies have a 2- to 3-fold increased risk of later developing asthma and hayfever.

Clinical responses to allergens

In westernized countries some estimates suggest that up to 30% of adults and 45% of children may suffer to a greater or lesser degree with allergies to grass pollens, animal danders, the feces from mites in house dust (Figure 14.5), and so on. Even if these are overestimates, it is clear that allergies affect huge numbers of people and that their incidence has increased substantially over the last few decades. A large number of allergens have been cloned (Table 14.2), several of which turn out to be enzymes. For example, the Der p 1 allergen from house dust mites is a cysteine protease that increases the permeability of the bronchial mucosa, thereby facilitating its own passage along with other allergens across the epithelium and allowing access to and sensitization of cells of the immune system. The CD23 low-affinity receptor for IgE (FcεRII) on B-cells downregulates IgE synthesis upon antigen-mediated cross-linking of the bound IgE. However, Der p 1 proteolytically cleaves CD23 and thereby reduces its negative impact on IgE synthesis. Furthermore, Der p 1 also cleaves CD25 (the IL-2 receptor α chain) on T-cells and thus limits the activation of Th1 cells, biasing the immune response to Th2-dependent IgE production.

The local anaphylactic reaction to injection of antigen into the skin of atopic patients is manifest as a *wheal and flare* (Figure 14.6), which is maximal at 30 minutes or so and

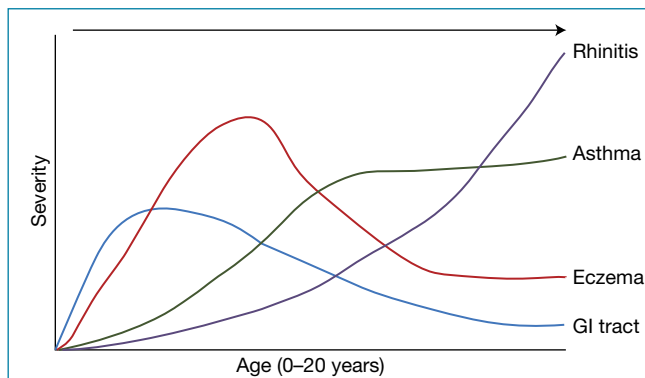


Figure 14.4 The allergy march. In many children there is a temporal progression in the development of allergies. Note, however, that quite often allergies develop simultaneously or that the order of progression can be different with, for example, rhinitis preceding asthma. (Adapted from Ulrich Wahn, World Allergy Organization.)



Figure 14.5 House dust mite – a major cause of allergic disease. The electron micrograph shows the rather nasty looking mite graced by the name *Dermatophagoides pteronyssinus* and fecal pellets on the bottom left. A typical double bed can contain up to 200 million mites, each mite producing approximately 20 fecal pellets/day and each pellet containing 0.2 ng of proteolytically active Der p 1 allergen. The biconcave pollen grains (top left) shown for comparison indicate the size of particle that can become airborne and reach the lungs. The mite itself is much too large for that. (Source: E. Tovey. Reproduced with permission.)

resolves within about an hour; it may be succeeded by a late phase response involving an infiltration by eosinophils which peaks at around 5 hours. Contact of the allergen with cell-bound IgE in the bronchial tree produces the symptoms of *asthma* whilst encounters in the nose and eyes results in *allergic rhinitis and conjunctivitis* (hayfever). Three hundred million individuals worldwide suffer from asthma and the World Health Organization estimates that the economic costs associated with asthma exceed those of tuberculosis and HIV/AIDS

Table 14.2 Some examples of allergens.

Category	Origin	Allergens	Example
Insect	House dust mite (<i>Dermatophagoides pteronyssinus</i>) feces	Der p 1–Der p 14	Der p 1: cysteine protease
	Honeybee (<i>Apis mellifera</i>) venom	Api m 1–7	Api m 1: phospholipase A ₂
	German cockroach (<i>Blattella germanica</i>)	Bla g 1–6	Bla g 2: aspartic protease
Companion animals	Cat (<i>Felis domesticus</i>)	Fel d 1–7	Fel d 4: lipocalin
	Dog (<i>Canis domesticus</i>)	Can f 1–4	Can f 3: albumin
Trees	Birch (<i>Betula verrucosa</i>)	Bet v 1–7	Bet v7: cyclophilin
	Hazel (<i>Corylus avellana</i>)	Cor a 1–11	Cor a 8: lipid transfer protein
Grasses and plants	Timothy grass (<i>Phleum pratense</i>)	Phl p 1–13	Phl p 13: polygalacturonase
	Perennial ryegrass (<i>Lolium perenne</i>)	Lol p 1–11	Lol p 11: trypsin inhibitor
	Short ragweed (<i>Ambrosia artemisiifolia</i>)	Amb a 1–7	Amb a 5: neurophysin
Molds	<i>Aspergillus fumigatus</i>	Asp f 1–23	Asp f 12: heat shock protein p90
	<i>Cladosporium herbarum</i>	Cla h 1–12	Cla h 3: aldehyde dehydrogenase
Foods	Peanut	Ara h 1–8	Ara h 1: vicilin
	Cows' milk (<i>Bos domesticus</i>)	Bos d 1–8	Bos d 4: α -lactalbumin
	Chickens' eggs (<i>Gallus domesticus</i>)	Gal d 1–5	Gal d 2: ovalbumin
Drugs	Penicillin	–	Amoxicillin
	Fluoroquinolone	–	Ciprofloxacin
Occupational allergens	Toluene diisocyanate	–	–
	Latex (derived from the rubber tree, <i>Hevea brasiliensis</i>)	Hev b 1–13	Hev b 1: elongation factor

For a complete list see International Union of Immunological Societies Allergen Nomenclature Sub-Committee (www.allergen.org).

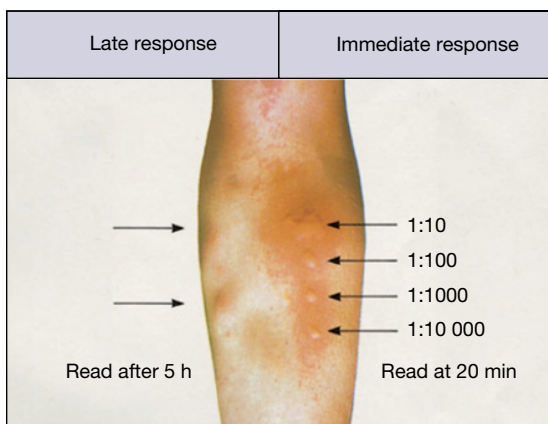


Figure 14.6 Atopic allergy. Skin prick tests with grass pollen allergen in a patient with typical summer hayfever. Skin tests were performed 5 hours (left) and 20 minutes (right) before the photograph was taken. The tests on the right show a typical titration of a type I immediate wheal and flare (alternatively described as wheal and erythema) reaction. The late phase skin reaction (left) can be clearly seen at 5 hours, especially where a large immediate response has preceded it. Figures for allergen dilution are given.

combined. Asthma can be associated with agents encountered in the workplace, and is then described as **occupational asthma**. Allergens here include toluene diisocyanate in spray paints, colophony fumes from solders used in the electronics industry, and danders (particles of old skin on animal hair) encountered by animal handlers. Although the majority of asthma patients have **extrinsic asthma** associated with **atopy** some patients are nonatopic and therefore are said to have **intrinsic or idiopathic asthma**.

Bronchial biopsy and lavage of asthmatic patients reveal **mast cells and eosinophils** as the major mediator-secreting effector cells, while T-cells provide the microenvironment required to sustain the chronic inflammatory response, which is an essential feature of the histopathology (Figure 14.7). The resulting variable airflow obstruction and bronchial hyperresponsiveness are the cardinal clinical and physiological features of the disease.

Atopy can also manifest itself as **eczema (atopic dermatitis)** (Figure 14.8), with house dust mite, domestic cats, and German cockroaches often proving to be the environmental offenders. Recalling the inflammation in asthma, skin patch tests with Der p 1 in these eczema patients produce an infiltrate of eosinophils, T-cells, mast cells, and basophils. The number

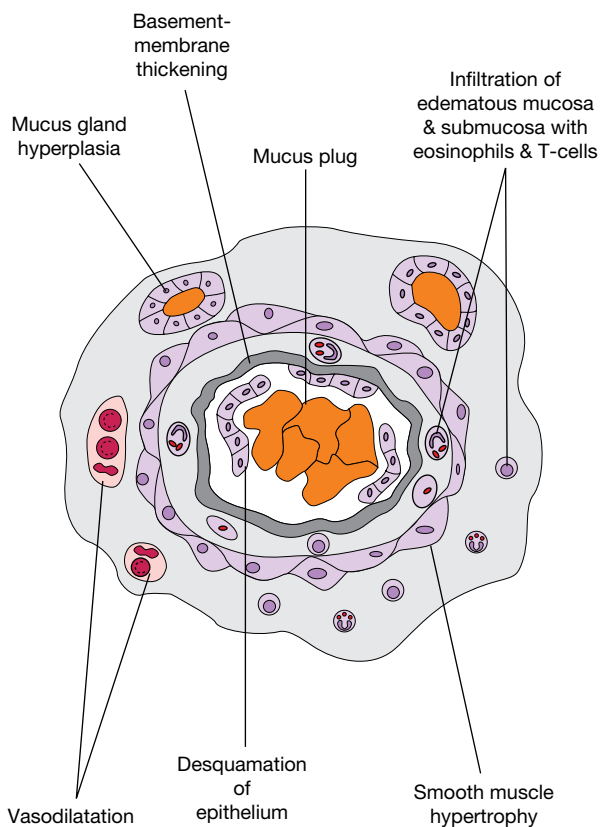


Figure 14.7 Pathological changes in asthma. Diagram of cross-section of an airway in severe asthma.

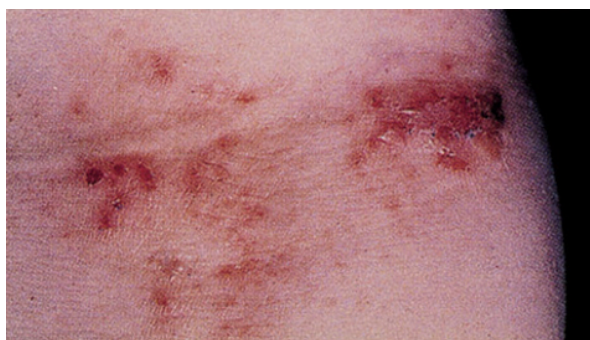


Figure 14.8 An atopic eczema reaction on the back of a knee of a child allergic to rice and eggs. (Source: J. Brostoff. Reproduced with permission.)

of individuals affected is comparable to the number affected by asthma. The beneficial effect of the calcineurin inhibitors cyclosporine and, more recently, topical tacrolimus in patients with eczema highlights the important role of T-cells in the pathogenesis of this disease.

Allergy to food antigens, although less prevalent than food intolerance (which is caused by, often ill-defined,

non-immunological factors), occurs in approximately 3–8% of children and 1–3% of adults. IgE sensitization to **food allergens** can occur in the **gastrointestinal tract** and it had previously been thought that potential allergens such as cows' milk, eggs, nuts, and shellfish should be avoided during pregnancy and breastfeeding and excluded from the infant's diet for the first couple of years. However, it has become apparent that this approach can actually lead to an increase rather than a decrease in food allergy. Therefore, whether or not to introduce commonly allergenic foods early in life is hotly debated.

Peanut allergy is seen in approximately 1% of children and, as with other allergens, reactions are sometimes life threatening or even occasionally fatal. Food additives such as sulfiting agents can also cause adverse reactions. The absence of food allergy in most individuals is thought to be due to IgA and IgG4 antibodies that effectively compete with IgE for binding to the allergen, and the presence of Foxp3⁺ regulatory T-cells capable of inhibiting both Th2 cells and mast cells. Contact of the food with specific IgE on mast cells in the gastrointestinal tract may produce local reactions resulting in abdominal pain, cramps, diarrhea, and vomiting, or may allow the allergen to enter the body by causing a change in gut permeability through mediator release; the allergen may complex with antibodies and cause distal lesions by depositing in the joints, for example, or it may diffuse freely to other sensitized sites, such as the skin (Figure 14.8) or lungs, where it will cause a further local anaphylactic reaction. Thus eating strawberries may produce **urticarial reactions** (**hives**, raised areas of itchy skin) and egg may precipitate an asthmatic attack in appropriately sensitized individuals. The role of the sensitized gut in acting as a "gate" to allow entry of allergens is strongly suggested by experiments in which oral sodium cromoglycate, a mast cell stabilizer, prevented subsequent asthma after ingestion of the provoking food (Figure 14.9).

Anaphylactic drug allergy is manifest in the dramatic responses to drugs such as **penicillin**, which haptenate body proteins by covalent coupling to induce IgE synthesis. In the case of penicillin, the β -lactam ring links to the ϵ -amino of lysine to form the penicilloyl determinant. The fine specificity of the IgE antibodies permits discrimination between closely similar drugs, such that some patients may be allergic to amoxicillin but tolerate benzylpenicillin, which differs by only very minor modifications of the side-chains (Figure 14.10).

Pathological mechanisms in asthma

Asthma affects approximately 10% of individuals worldwide. We should now look in more depth at those events that generate the chronicity of asthma. There is an **early phase** bronchial response to inhaled antigen essentially involving mast cell mediators, and an inflammatory **late phase** dominated by eosinophils. **Both phases are IgE-dependent** as shown by their marked attenuation in asthma patients treated with the humanized monoclonal anti-IgE antibody **omalizumab**, which reduces IgE to almost undetectable levels. Activated Th2 cells

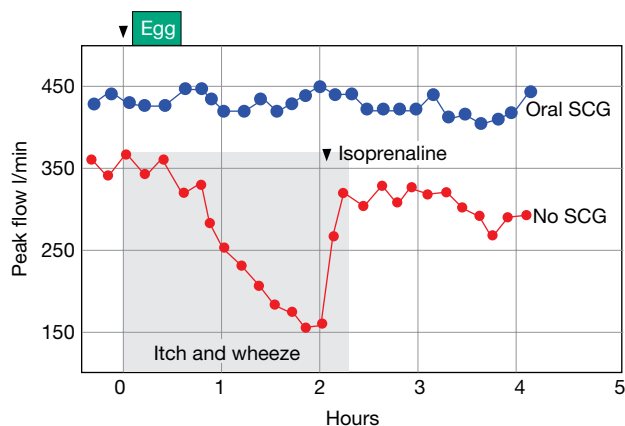


Figure 14.9 The role of gut sensitivity in the development of asthma to food allergens. A patient challenged by feeding with egg developed asthma within hours, as shown here by the depressed lung function test of measuring peak air flow. The symptoms at the end-organ stage were counteracted by the β -adrenoreceptor agonist isoprenaline. However, oral sodium cromoglycate (SCG), which prevents antigen-specific mast cell triggering, also prevented the onset of asthma after oral challenge with egg. Note that SCG taken orally has no effect on the response of an asthmatic to inhaled allergen. (Source: Brostoff J. (1986) In *Food Allergy* (eds. Brostoff J. and Challacombe S.J.). Baillière Tindall, London, p. 441. Reproduced with permission of Elsevier.)

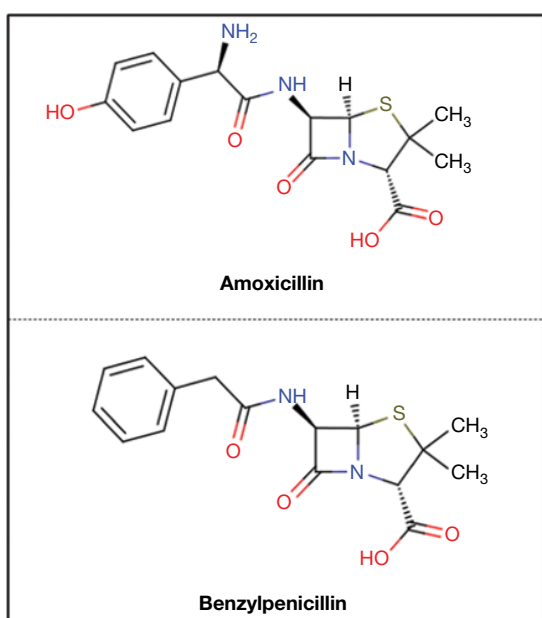


Figure 14.10 Drug allergy. The ability of the IgE-mediated allergic response to distinguish between two closely related antibiotics, amoxicillin and benzylpenicillin, is both of clinical importance for the treatment of bacterial disease in drug allergic patients and a beautiful example of the fine discriminatory power of the adaptive immune response.

and a cell type referred to as group 2 innate lymphoid cells (ILC2) produce IL-13, which is a key mediator of the asthma-associated structural changes referred to as **airway remodeling**, which involve thickening of the airway walls and increases in the adventitia (the outermost connective tissue), submucosal tissue, and smooth muscle. Following damage, the airway epithelium secretes the cytokines IL-25, IL-33, and thymic stromal lymphopoietin (TSLP), which collectively are involved in the activation of Th2 cells, ILC2 cells, dendritic cells, mast cells, basophils, eosinophils, and NKT cells. By secreting the Th2-type cytokines IL-5 and IL-13, the innate ILC2 cells help strengthen the adaptive Th2 response.

The mast cells also contribute to eosinophil recruitment by secretion of tryptase, which can activate coagulation factor II receptor-like 1 (F2RL1, protease-activated receptor-2 [PAR-2]) on the surface of endothelial and epithelial cells, fibroblasts and smooth muscle. Activation of the receptor leads to TNF, IL-1 β , and IL-4 production, promoting the expression of the vascular endothelial adhesion molecules VCAM-1, ICAM-1, and P-selectin, which recruit eosinophils and basophils. An important trigger of the late phase reaction is the **activation of alveolar macrophages** through the interaction of allergen with IgE bound to the low-affinity Fc ϵ RII, leading to a significant increase in the production of TNF and IL-1 β . These cytokines stimulate the release of the powerful **eosinophil chemoattractants** CCL5 (RANTES), CCL11 (eotaxin), and CCL12 (MCP5) from bronchial epithelial cells and fibroblasts. Note also that CCL5 and CCL11 can contribute directly to local inflammation by IgE-independent degranulation of basophils.

A new player now enters the field: primed T-cells traffic into the inflamed site under the influence of CCL11. Along with cytokine secretion by the ILC2 cells mentioned above, the transcription factors GATA-3 and c-maf, and the presence of prostaglandin E₂ all promote **Th2 development**, and responses are heavily skewed towards this particular T-cell subset in **asthma** (Figure 14.11). Encounter with allergen-derived peptides on antigen-presenting cells will promote the synthesis of IL-4, IL-5, and IL-13. IL-4 stimulates further CCL11 release, while IL-5 upregulates chemokine receptors on eosinophils, maintains their survival through an inhibitory effect on natural apoptosis and is involved in their longer term recruitment from bone marrow. Th17 cells are also present and promote both neutrophil and macrophage inflammatory responses in the lung.

Things now look bad for the bronchial tissues and a multitude of factors contribute to allergen-induced airway dysfunction: (i) a virtual soup of **bronchoconstrictors**, the leukotrienes being especially important, bathe the smooth muscle cells; (ii) **edema** of the airway wall; (iii) altered neural regulation of airway tone through binding of eosinophil major basic protein (MBP) to M2 autoreceptors on the nerve endings with increased release of **acetylcholine**; (iv) airway **epithelial cell desquamation** due to the toxic action of MBP, there being a strong correlation between the number of desquamated cells in bronchoalveolar lavage fluid and the concentration of MBP; (v) **mucus hypersecretion** due to IL-13 and, to a lesser extent,

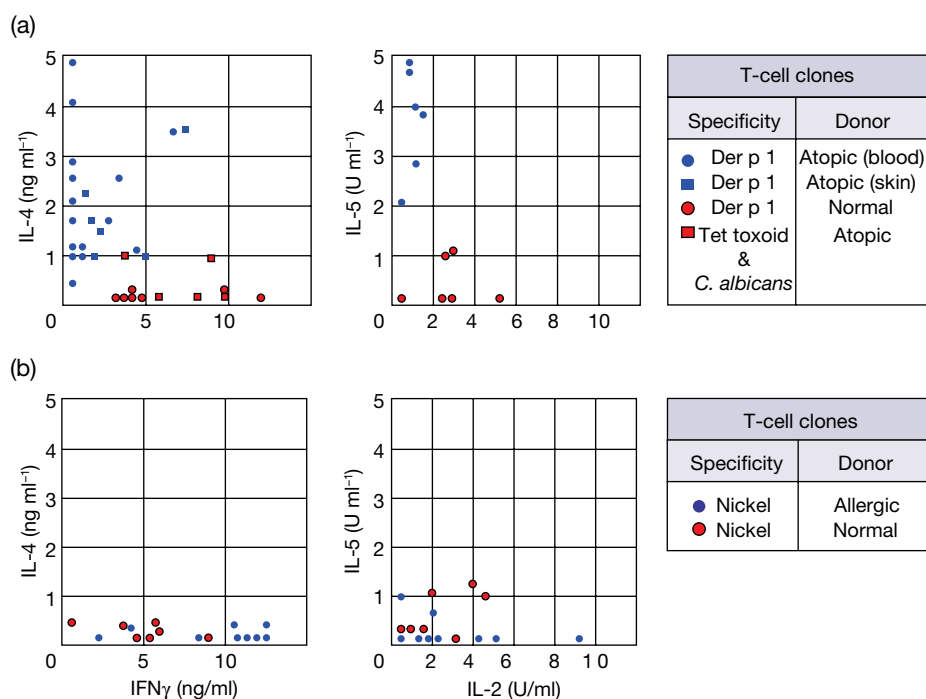


Figure 14.11 Th2 dominance in atopic allergy. Shown by cytokine profiles of antigen-specific CD4 T-cell clones from (a) patients with type I atopic allergy and (b) subjects with type IV contact sensitivity, compared with normal controls. Each point represents the value for an individual clone. Archetypal Th1 clones have high IFN γ and IL-2 and low IL-4 and IL-5; Th2 clones show the converse. The high level of IL-4 drives the switch to IgE production by B-cells and further promotes the Th2 bias. (Data source: Kapsenberg M.L. *et al.* (1991) *Immunology Today* **12**, 392.)

IL-4, leukotrienes and platelet activating factor acting on sub-mucosal glands and their controlling neural elements; and finally (vi) a repair-type response involving the production of fibroblast growth factor, TGF β , and platelet-derived growth factor, the laying down of collagen, scar and fibrous tissue and hypertrophy of smooth muscle, leading to an exaggerated narrowing of the airways (i.e., bronchoconstriction) in response to a variety of environmental stimuli (Figure 14.7). The wide variety of cytokines and mediators produced by lung epithelial (including endothelial) cells, fibroblasts, and smooth muscle cells may account for the persistence of airway inflammation and the permanent structural changes in chronic disease sufferers, even in the absence or apparent absence of ongoing exposure to inhalant allergens to which subjects are sensitized, a state where conventional immunotherapy might not be expected to be beneficial.

Unlike atopic asthmatics, *intrinsic asthmatics* have negative skin tests to common aeroallergens, no clinical or family history of allergy, normal levels of serum IgE, and no detectable specific IgE antibodies to common allergens. Nonetheless, they resemble the atopics in important respects: bronchial biopsies show enhanced expression of IL-4, IL-13, CCL5, and CCL11, and of the mRNA for the ϵ heavy chain, suggestive of local IgE synthesis. Is there a role for virus-specific IgE or for IgE autoantibodies to the Fc ϵ RI?

Hayfever

The most common manifestations of hayfever, which will be all too familiar to many reading this text, are rhinitis (inflammation inside the nose causing sneezing and the nose to become blocked or runny) and conjunctivitis (redness and inflammation of the conjunctiva of the eyes, which feel itchy). Although not a particularly serious disease, it can have a substantial negative impact on quality of life. The offending allergens are present in tree, grass, or weed pollens. Genome-wide association studies (GWAS) have identified nearly 20 genes that contribute to susceptibility to develop hayfever. Allergic rhinitis shares many pathological features with asthma, which is perhaps not too surprising considering that both conditions affect the airways. However, although there is often extensive damage to the epithelium in asthma, there is usually rather minimal damage to the nasal epithelium. The immunological processes occurring are rather similar, with, for example, increased numbers of CD4⁺ T-cells and of eosinophils, and local production of IgE and cytokines such as IL-5 being a feature of both conditions.

Eczema

The barrier function of skin plays a key role in excluding allergens and mutations in the gene encoding filaggrin, a key component of the barrier, are found in some patients with

atopic dermatitis (eczema). Skin Langerhans cells and other populations of dendritic cells express FcεRI, and incoming allergens are taken up as allergen–IgE complexes and passed to the MHC class II processing pathway for presentation to Th2 cells. Keratinocytes in patients with atopic dermatitis produce substantial amounts of a cytokine called thymic stromal lymphopoietin (TSLP), which help dendritic cells to drive Th2 cell differentiation. CC chemokines produced by keratinocytes and fibroblasts preferentially attract eosinophils and the skin-homing CLA⁺ memory Th2-cells. The latter comprise 80–90% of the T-cells in the infiltrate (at least during the early stages of inflammation), account for most of the specific response to the offending allergen, and produce a variety of cytokines including IL-4, IL-13, and IL-31. Interleukin-31, in particular, has inhibitory effects on the differentiation of epidermal cells. Patients with atopic dermatitis are prone to infection, particularly with *Staphylococcus aureus*, and as the skin lesions develop there is increasing involvement of Th1, Th17, and Th22 cells in response to microbial challenges. As their name suggests, Th22 cells predominantly secrete IL-22, along with IL-13 and TNF.

Etiology of allergy

There is a strong familial predisposition to the development of atopic allergy (Figure 14.12) suggestive of genetic factors. In one study looking at peanut allergy, monozygotic twins had a concordance rate of 64% compared to 7% in dizygotic twins. It is clear that the development of atopic allergy depends upon complex multiple genetic interactions with various environmental factors. Age, sex, infection history, nutritional status, and allergen exposure all play a role. One obvious factor is the overall ability to synthesize the IgE isotype – the higher the level of IgE in the blood, the greater the likelihood of becoming atopic (Figure 14.12). Genetic studies have provided evidence that many different genes contribute to susceptibility to develop asthma, including HLA-DQ, those encoding the cytokines IL-33 and TSLP, the cytokine receptors IL-33R and the IL-2R β chain, and the transcription factor SMAD3 (Figure 14.13) although no one single gene is a particularly strong predisposing factor on its own.

One interesting association, however, is with polymorphisms in a number of pattern recognition receptors (PRRs). What relevance might this have for atopic disease? Well, the PRR-mediated recognition of pathogens by dendritic cells is important in developing the correct balance between Th1 and Th2 responses. Current thinking goes along the following lines. At the time of birth the neonatal immune system is skewed towards Th2-type responses, but in the face of a hostile microbial environment there is a shift towards Th1 responses. This shift extends to inhaled allergens, and is sometimes referred to as immune deviation. However, in the absence of repeated infections with common pathogens (due to a “cleaner” environment and widespread early use of antibiotics) the

immune system maintains a Th2 phenotype, which will favor the secretion of IL-4 and IL-13 (promoting IgE production) and IL-5 (promoting eosinophilia). This idea forms the basis of the hygiene hypothesis put forward to explain the rise in allergies seen in highly developed countries, and even more tellingly in countries that **become** highly developed, such as the former East Germany, where levels of atopic allergy started to catch up with those in West Germany following reunification. The overall picture relating to economic development is, however, complex – let us not forget that a finger has been pointed at environmental pollutants such as diesel exhaust particles as cofactors for asthma attacks.

Recently there has also been a great deal of interest in trying to more fully understand the role of the barrier function of the epithelium in allergic responses. Compromise of the normally tight junctions between the epithelial cells, perhaps caused by chemical or physical pollutants or by infection, will clearly lead to increased access of both pathogens and allergens.

Diagnosis

Sensitivity is normally assessed by the response to intradermal challenge with antigen. The release of histamine and other mediators rapidly produces a **wheal and flare** (see Figure 14.6), maximal within 30 minutes and then subsiding. These immediate wheal and flare reactions may be followed by a late phase reaction in the injected skin (see Figure 14.6), which sometimes lasts for 24 hours, redolent of those seen following challenge of the bronchi and nasal mucosa of allergic subjects and similarly characterized by dense infiltration with eosinophils and T-cells.

The correlation between skin prick test responses and measurement of allergen-specific serum IgE is fairly good. In some instances, intranasal challenge with allergen may provoke a response even when both of these tests are negative, probably as a result of local synthesis of IgE antibodies.

Therapy

If one considers the sequence of reactions from initial exposure to allergen right through to the production of atopic disease, it can be seen that several points in the chain provide legitimate targets for therapy (Figure 14.14).

Allergen avoidance

In individuals where the offending allergen(s) has/have been identified, avoidance of contact with the allergen(s) is desirable but sometimes problematic. The reluctance of some parents to dispose of the family cat to stop little Algernon's wheezing is sometimes quite surprising.

Desensitization immunotherapy

Repeated **subcutaneous injection** of small amounts of allergen can lead to worthwhile improvement in individuals subject to insect venom anaphylaxis or hayfever. Studies are ongoing to assess the benefit of extending this approach to

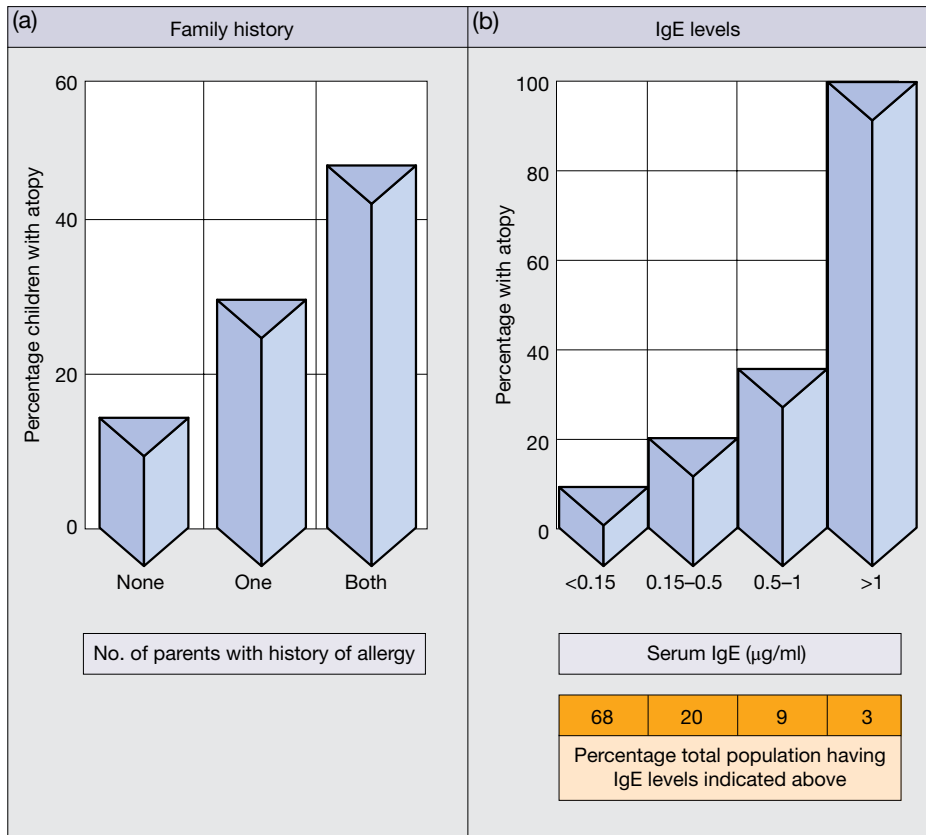


Figure 14.12 Risk factors in allergy. (a) Family history; (b) IgE levels – the higher the serum IgE concentration, the greater the chance of developing atopy.

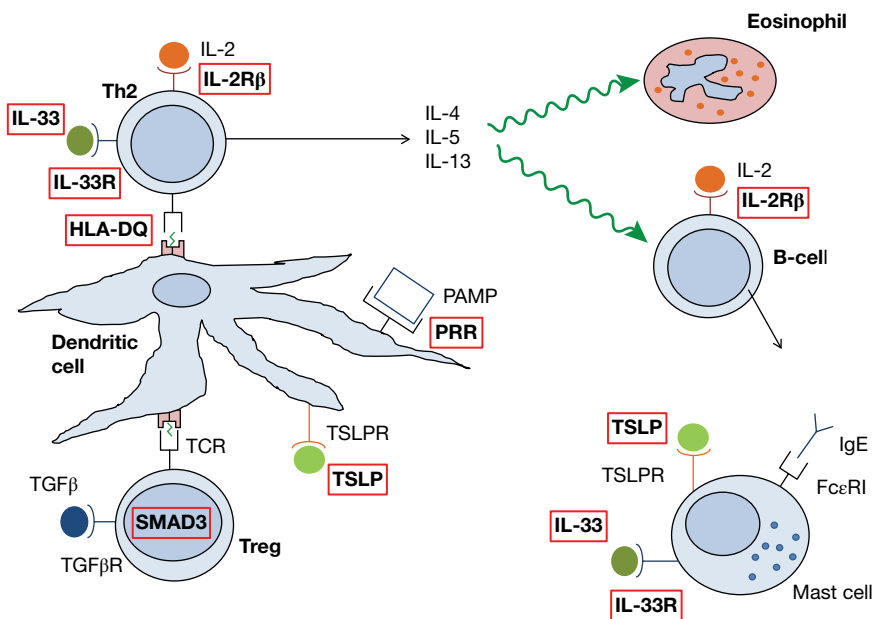


Figure 14.13 Gene products that influence susceptibility to asthma. Multiple genes have been implicated that act at various stages in the type I hypersensitivity response. Examples include those indicated by red boxes. IL-2R β , interleukin-2 receptor β chain; PAMP, pathogen-associated molecular pattern; PRR, pattern recognition receptor; TSLP, thymic stromal lymphopoietin; TSLPR, TSLP receptor.

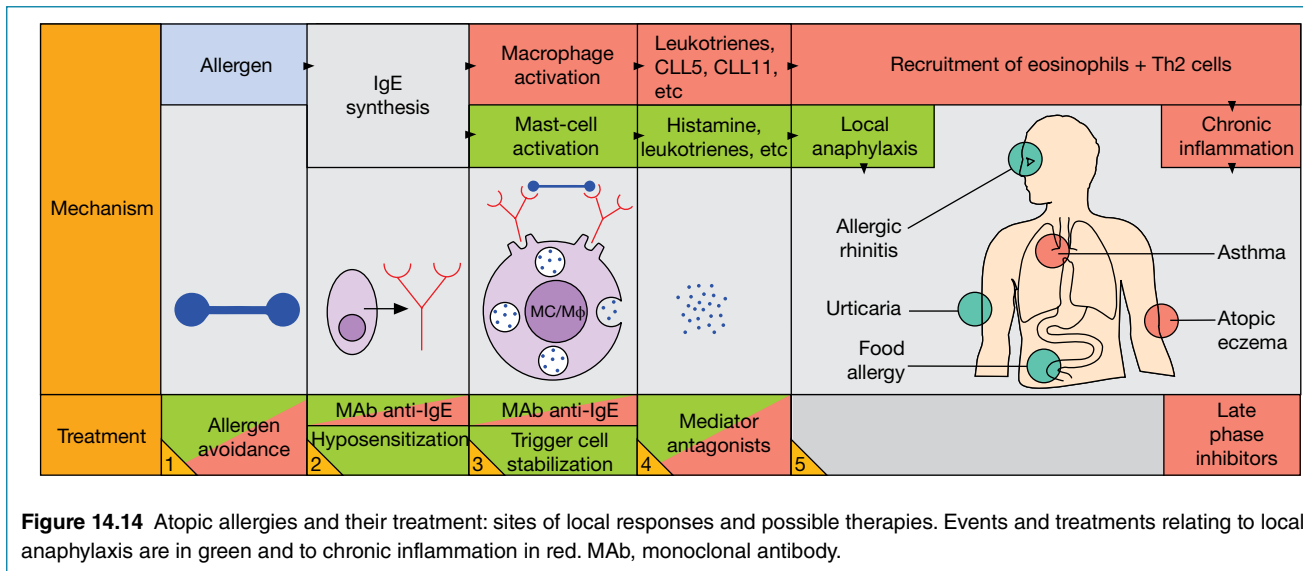


Figure 14.14 Atopic allergies and their treatment: sites of local responses and possible therapies. Events and treatments relating to local anaphylaxis are in green and to chronic inflammation in red. MAB, monoclonal antibody.

patients with asthma and eczema. **Sublingual allergen immunotherapy (SLIT)** can be self administered at home and carries less risk of severe systemic reactions than subcutaneous administration, but this has to be balanced against the fact that it is sometimes not quite as effective as injection immunotherapy. The mechanism(s) by which desensitization works is not entirely clear but it may boost the synthesis of IgG “blocking” antibodies which divert the allergen from contact with tissue-bound IgE and/or downregulate IgE synthesis by engagement of the FcγRIIB receptor on B-cells by allergen-specific IgG linked to allergen molecules bound to surface IgE receptors (see Chapter 9 on IgG regulation of Ab production). Additionally, T-lymphocyte cooperation is important for IgE synthesis and eosinophil-mediated pathogenesis, and therefore the beneficial effects of antigen exposure may also be mediated through induction of anergic or regulatory T-cells and a switch from Th2 to Th1 cytokine production.

Blocking the action of IgE

We have already mentioned the humanized monoclonal **omalizumab** directed against the FcεRI-binding Cε3 domain of IgE, which provides a relatively new therapy for severe forms of asthma. It reduces the circulating IgE levels almost to vanishing point by direct neutralization, and as a secondary effect this decreases the IgE-dependent expression of the FcεRI receptor on mast cells. Thus there are far fewer receptors on the mast cell to bind IgE, and virtually no IgE to be bound anyway. It is not surprising, therefore, that this antibody successfully completed clinical trials and was subsequently approved by the FDA for use in those adults and adolescents with moderate or severe persistent atopic asthma whose symptoms are inadequately controlled with inhaled corticosteroids. Omalizumab is also licensed for use in adults and adolescents with chronic idiopathic urticaria whose symptoms are not fully controlled by antihistamines.

Inhibiting the effector cells

Much relief has been obtained with agents such as inhaled **isoprenaline** and **sodium cromoglycate** (cromolyn sodium), which prevent mast cell activation. Sodium cromoglycate blocks chloride channel activity and maintains cells in a normal resting physiological state, which probably accounts for its inhibitory effects on a wide range of cellular functions, such as mast cell degranulation, eosinophil and neutrophil chemotaxis and mediator release, and reflex bronchoconstriction. Some or all of these effects are responsible for its anti-asthmatic actions.

The triggering of macrophages through allergen interaction with surface-bound IgE is clearly a major initiating factor for late reactions, as discussed earlier, and resistance to this stimulus can be very effectively achieved with corticosteroids. Unquestionably, **inhaled corticosteroids** have revolutionized the treatment of asthma. Their principal action is to suppress the transcription of multiple inflammatory genes, including in the present context those encoding several cytokines.

Mediator antagonism

Histamine H1-receptor antagonists have for long proved helpful in the symptomatic treatment of atopic disease. Newer drugs of this class such as **loratadine** and **fexofenadine** are effective in rhinitis and in reducing the itch in atopic dermatitis, although they have little benefit in asthma. **Cetirizine** additionally has useful effects on eosinophil recruitment in the late phase reaction. Short-acting selective **β₂-agonists** such as Ventolin, the active ingredient of which is **albuterol** (salbutamol), are inhaled to alleviate mild-to-moderate symptoms of asthma. Such β-adrenergic receptor agonist drugs increase cAMP levels leading to relaxation of bronchial smooth muscle and inhibition of mast cell degranulation. An important advance was the introduction of **long-acting β₂-agonists** such as **salmeterol** and **formoterol** which, although potentially carrying a risk of substantial side-effects, protect against bronchoconstriction for over 12 hours and can be used over a short

period to bring symptoms under control when treatment with other drugs are insufficient. Potent **leukotriene receptor antagonists** such as **montelukast** are also effective in asthma and allergic rhinitis.

Theophylline was introduced for the treatment of asthma nearly 100 years ago and, as a **phosphodiesterase (PDE) inhibitor**, it increases intracellular cAMP, thereby causing bronchodilatation.

Limiting chronic inflammation

Certain drugs impede atopic disease at more than one stage. **Cetirizine** is a case in point with its dual effects on the histamine receptor and on eosinophil recruitment. **Corticosteroids** seem to do almost everything; apart from their role in stabilizing macrophages, they solidly inhibit the activation and proliferation of Th2 cells, which are the dominant underlying driving force in chronic asthma, and may call a halt to the development of irreversible narrowing of the airways. So it is that inhaled steroids (e.g., budesonide, mometasone, fluticasone) with high anti-inflammatory potency but minimal side-effects owing to hepatic metabolism, provide first-line therapy for most chronic asthmatics.

Type II hypersensitivity – antibody-dependent cytotoxicity

Where an antigen is present on the surface of a cell, recognition by antibody has the potential to lead to the death of that cell by complement-mediated or cell-mediated cytotoxicity (Figure 14.15). Activation of complement can occur via the

classical pathway and, unless the cells are protected by complement regulatory proteins (which will in fact usually be the case), then the production of membrane attack complex (MAC) will lead to cell death. In type II hypersensitivity, excessive generation of MAC will swamp the protective effect of cell surface complement regulatory proteins.

A quite distinct cytotoxic mechanism, **antibody-dependent cellular cytotoxicity (ADCC)**, occurs when target cells coated with antibody are killed through an extracellular non-phagocytic process involving leukocytes that bind to the target by their specific Fc receptors (e.g., Fc γ R in the case of IgG; Figure 14.15). ADCC can be mediated by a number of different types of leukocyte, including NK cells, monocytes, neutrophils, and eosinophils. Although readily observed as a phenomenon *in vitro* (e.g., schistosomules coated with either IgG or IgE can be killed by eosinophils; see Figure 11.25), whether ADCC plays a role *in vivo* remains a tricky question. Functionally this extracellular cytotoxic mechanism would be expected to be of significance where the target is too large for ingestion by phagocytosis (e.g., large parasites and solid tumors). It could also act as a back-up system for T-cell-mediated killing.

Type II reactions between members of the same species (alloimmune reactions)

Transfusion reactions

Antibodies to the A or B antigens of the **ABO blood groups** (Figure 14.16) occur spontaneously when the antigen is absent from the red cell surface; thus a person of blood group A will

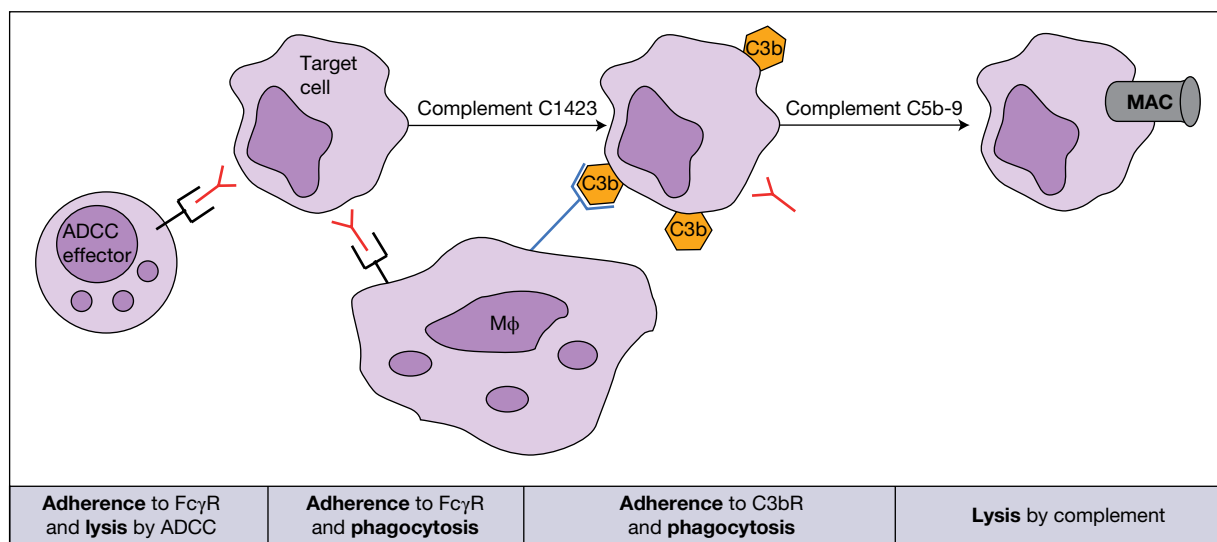


Figure 14.15 Antibody-dependent cytotoxic hypersensitivity (type II). Antibodies directed against cell surface antigens cause cell death not only by complement-dependent lysis using the C5b–C9 membrane attack complex (MAC) but also by Fc γ and C3b adherence reactions leading to phagocytosis, or through nonphagocytic extracellular killing by antibody-dependent cellular cytotoxicity (ADCC). Human monocytes and IFN γ -activated neutrophils kill Ab-coated tumor cells using their Fc γ RI receptors; NK cells kill targets through Fc γ RIII receptors.

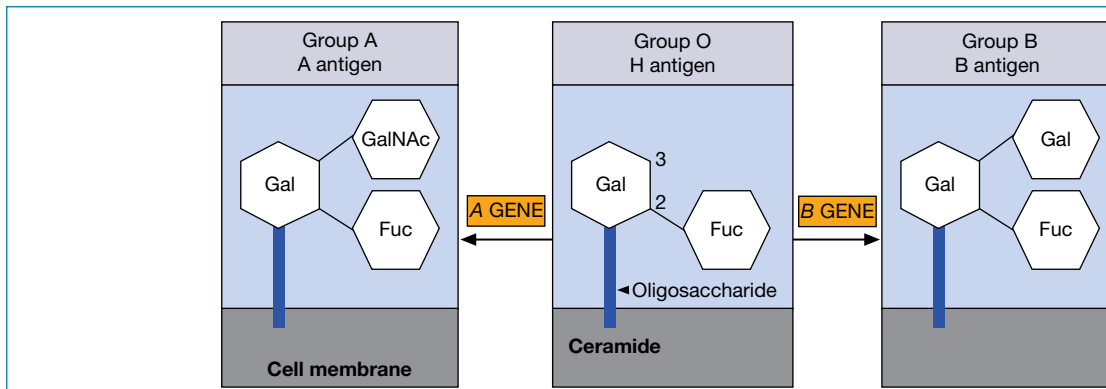


Figure 14.16 The ABO system. The allelic genes A and B code for transferases that add either *N*-acetylgalactosamine (GalNAc) or galactose (Gal), respectively, to H substance. The oligosaccharide is anchored to the cell membrane by coupling to a sphingomyelin called ceramide. Eighty-five percent of the population secrete blood group substances in the saliva, where the oligosaccharides are present as soluble polypeptide conjugates formed under the action of a secretor (*se*) gene. Fuc, fucose.

Table 14.3 ABO blood groups and serum antibodies.

Blood group (phenotype)	Genotype	Antigen	Serum antibody
A	AA, AO	A	Anti-B
B	BB, BO	B	Anti-A
AB	AB	A and B	None
O	OO	H	Anti-A Anti-B

possess anti-B, someone of blood group B will have anti-A, and someone of blood group O will possess both anti-A and anti-B. These *isohemagglutinins* are usually IgM and belong to the class of “natural antibodies” (Table 14.3). On transfusion, mismatched red cells will be coated by the isohemagglutinins, which will cause severe complement-mediated intravascular hemolysis. Clinical refractoriness to platelet transfusions is frequently due to HLA alloimmunization, but one can usually circumvent this problem by depleting the platelets of leukocytes.

Maternal antibodies

The *Rh* (*rhesus*) blood groups form the other major antigenic system. Of particular note is the fact that a mother with an RhD-negative blood group (i.e., *dd* genotype) can readily be sensitized by red cells from a baby carrying RhD antigens (*DD* or *Dd* genotype). This occurs most often at the birth of the first child when a placental bleed can release a large number of the baby’s erythrocytes into the mother. The antibodies formed are predominantly of the IgG class and, unlike the IgM anti-A and anti-B mentioned above for the ABO blood group system, are therefore able to cross the placenta in any subsequent pregnancy. Reaction with the D-antigen on the fetal red cells leads to their destruction through opsonic adherence, causing hemolytic disease of the fetus and newborn (erythroblastosis fetalis) (Figure 14.17a,b).

These anti-D antibodies fail to agglutinate RhD-positive red cells *in vitro* because of the low density of antigenic sites, but erythrocytes coated with anti-D can be made to agglutinate by addition of an anti-immunoglobulin serum (Coombs’ test; Figure 14.18).

RhD-negative mothers are treated prophylactically with IgG anti-D at 28 weeks and 34 weeks gestation and then again within 72 hours of delivery if the baby is RhD-positive (Figure 14.17c). This eliminates the risk of sensitization by causing the rapid phagocytic removal of RhD-positive red cells from the mother’s circulation before the fetal erythrocytes are able to prime a maternal immune response, and perhaps also by downregulatory effects on maternal B-cells via the inhibitory FcγRIIb receptor.

Another disease resulting from transplacental passage of maternal antibodies is *neonatal alloimmune thrombocytopenia*. The fall in platelet numbers is greatly ameliorated by intravenous injections of pooled human IgG (IVIg). The efficacy of Fcγ fragments and of anti-FcγR suggests that this works by blockade of the Fcγ receptors.

Solid organ allografts

Allografts can provoke the production of antibodies, particularly against mismatched MHC antigens, in transplant recipients. The antibodies may be directly cytotoxic by

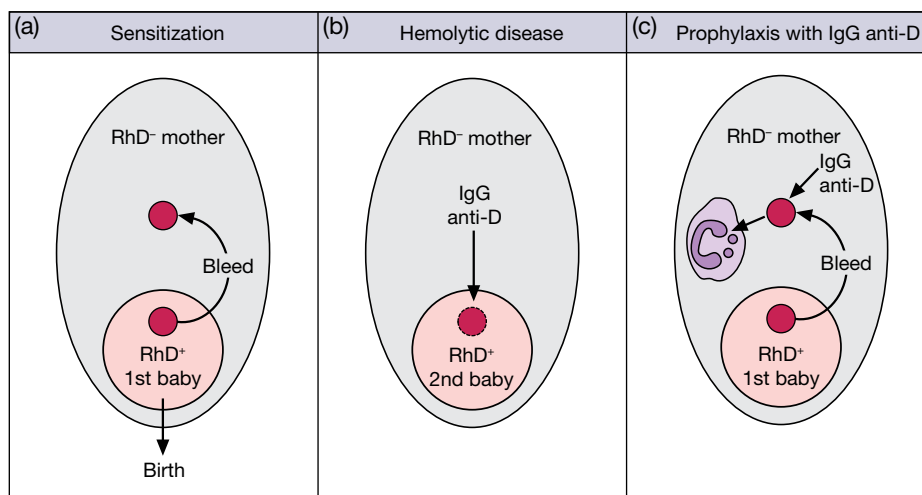


Figure 14.17 Hemolytic disease of the fetus and newborn due to rhesus incompatibility. (a) RhD-positive red cells from the first baby sensitize the RhD-negative mother. (b) The mother's IgG anti-D crosses the placenta and coats the erythrocytes of the second RhD-positive baby, causing type II hypersensitivity hemolytic disease. (c) IgG anti-D given prophylactically during the first pregnancy and birth removes the baby's red cells through phagocytosis and prevents sensitization of the mother.

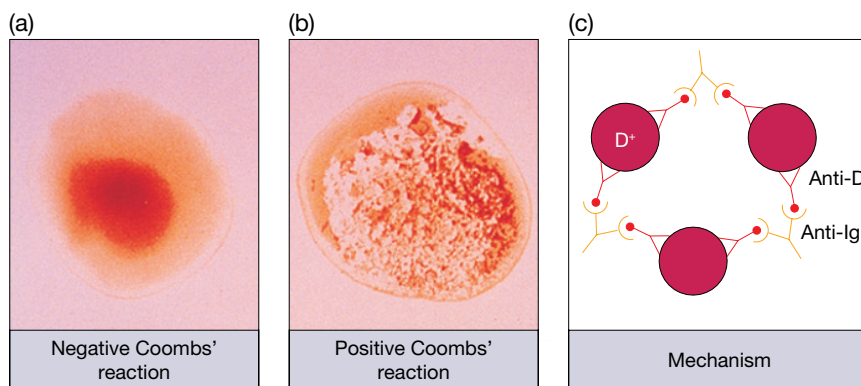


Figure 14.18 The Coombs' test for antibody-coated red cells. This test is used for detecting rhesus antibodies and in the diagnosis of autoimmune hemolytic anemia. (Source: A. Cooke. Reproduced with permission.)

activating complement, or cause adherence of phagocytic cells or attack by ADCC. The antibodies may also lead to platelet adherence when they bind antigens on the surface of the vascular endothelium (see Figure 15.6). Hyperacute rejection is caused by preformed antibodies in the graft recipient.

Autoimmune type II hypersensitivity reactions

Autoantibodies to the patient's own red cells are produced in *autoimmune hemolytic anemia*. They react at 37°C with epitopes on antigens of the rhesus complex distinct from those that incite transfusion reactions. Erythrocytes coated with these antibodies have a shortened half-life, largely through their adherence to splenic macrophages. Similar mechanisms account for the anemia in patients with cold hemagglutinin

disease who have monoclonal anti-I after infection with *Mycoplasma pneumoniae*, and in some cases of paroxysmal cold hemoglobinuria associated with the actively lytic Donath–Landsteiner antibodies specific for blood group P. These antibodies are primarily of IgM isotype and only react at temperatures well below 37°C. IgG autoantibodies against platelet surface glycoproteins are responsible for the depletion of platelets in *idiopathic thrombocytopenic purpura*, primarily through Fcγ receptor-mediated clearance by tissue macrophages in spleen and liver.

In Goodpasture's syndrome, autoantibodies recognize type IV collagen in kidney glomerular basement membrane. These antibodies, together with complement components, bind to the basement membranes where the action of the full complement system leads to serious damage (Figure 14.19a).

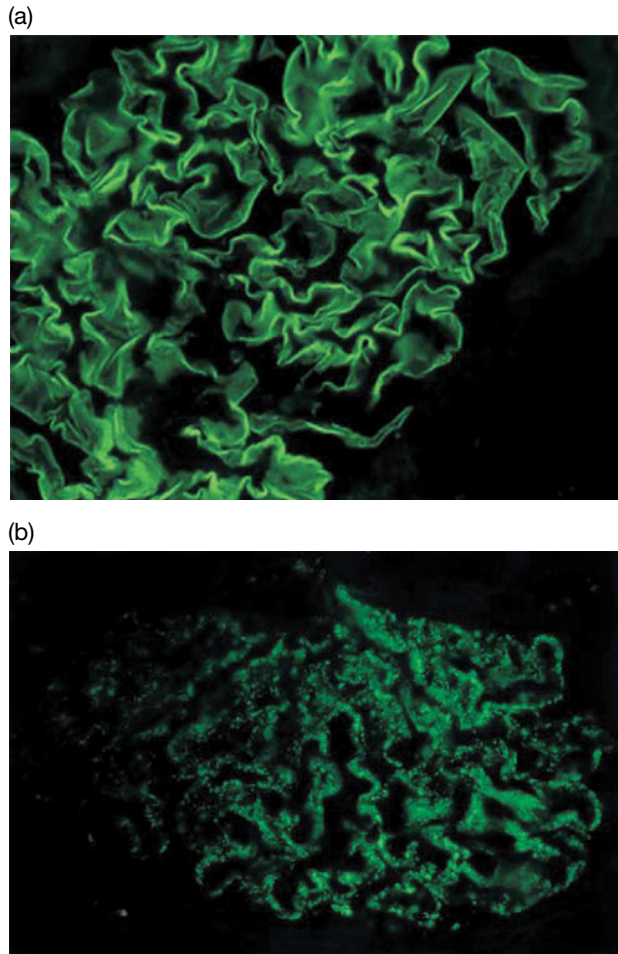


Figure 14.19 Glomerulonephritis. (a) In Goodpasture's syndrome due to a type II hypersensitivity with linear deposition of antibody to glomerular basement membrane, here visualized by staining the human kidney biopsy with a fluorescent anti-IgG; and in contrast to (b) in systemic lupus erythematosus (SLE), where a type III hypersensitivity is associated with deposition of antigen–antibody complexes, which can be seen as discrete masses lining the glomerular basement membrane following immunofluorescent staining with anti-IgG. Similar patterns to these are obtained with a fluorescent anti-C3. (Source: S. Thiru. Reproduced with permission.)

One could also include the stripping of acetylcholine receptors from the muscle endplate by autoantibodies in myasthenia gravis as a further example of type II hypersensitivity.

Type II drug reactions

Drugs can become coupled to body components and thereby undergo conversion from a hapten to a full immunogen that may elicit an immune response in some individuals. If the drug forms an immunogenic complex with the surface of circulating blood cells it gains the potential to stimulate the production of antibodies that are cytotoxic for the cell–drug complex. When the drug is withdrawn, the sensitivity is no longer evident.

Examples of this mechanism occur in the *hemolytic anemia* sometimes associated with continued administration of chlorpromazine or phenacetin, in the *agranulocytosis* associated with amidopyrine or of quinidine, and in a subset of patients with *thrombocytopenic purpura* treated with excessive amounts of penicillin.

Type III hypersensitivity – immune complex-mediated

The body may be exposed to excessive amounts of antigen over a protracted period of time in a number of circumstances: persistent infection, autoimmunity to self-components, and repeated contact with environmental agents. The union of such antigens and antibodies to form a complex within the body may well give rise to acute inflammatory reactions through a variety of mechanisms (Figure 14.20). For a start, intravascular complexes can aggregate platelets (Figure 14.20a) with two consequences: they provide a source of vasoactive amines and may also form microthrombi that can lead to local ischemia (reduced blood supply and thus reduced oxygen to the tissues). Immune complexes can also stimulate macrophages, through their Fc γ receptors, to generate the release of proinflammatory cytokines IL-1 β and TNF, reactive oxygen intermediates, and nitric oxide (Figure 14.20b). Complexes that are insoluble often cannot be digested after phagocytosis by macrophages and so provide a persistent activating stimulus. If complement is activated, the generation of the C5a chemotactic factor will lead to an influx of neutrophils (Figure 14.20c), which phagocytose (or try to phagocytose) the immune complexes; this in turn results in the extracellular release of the neutrophil granule contents, particularly when the complex is deposited on a basement membrane and cannot be phagocytosed (so-called “frustrated phagocytosis”). The proteolytic enzymes (including neutral proteases and collagenase), kinin-forming enzymes, polycationic proteins, and reactive oxygen and nitrogen intermediates that are released will, of course, damage local tissues and intensify the inflammatory responses. The anaphylatoxins C3a and C5a produced following complement activation will cause release of mast cell mediators, resulting in vascular permeability changes (Figure 14.20d). Further havoc may be mediated by a process referred to as reactive lysis, in which activated C5, C6, and C7 becomes attached to the surface of nearby cells (even though they are not sensitized with antibody) and subsequently binds C8 and C9. Given all these potential consequences of immune complex formation the need for the system of inhibitors present in the body should be absolutely clear.

The outcome of the formation of immune complexes *in vivo* depends not only on the absolute amounts of antigen and antibody but also on their relative proportions, which govern the nature of the complexes and hence their distribution within the body. Between *antibody excess* and *mild antigen excess*, the complexes are rapidly precipitated and

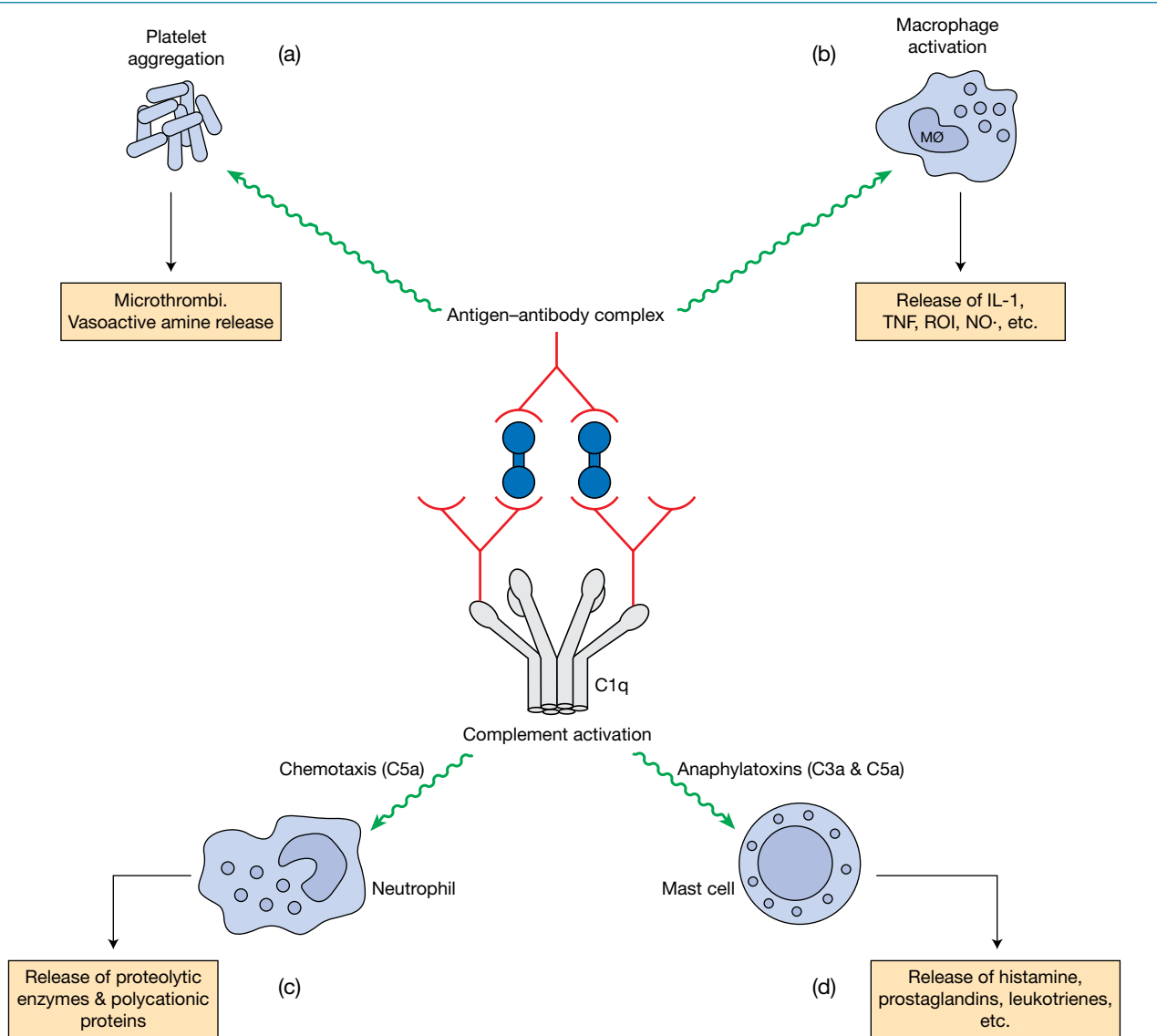


Figure 14.20 Immune complex-mediated (type III) hypersensitivity – underlying pathogenic mechanisms. ROI, reactive oxygen intermediates; NO, nitric oxide.

tend to be localized to the site of introduction of antigen, whereas in *moderate* to *gross antigen excess*, soluble complexes are formed.

Covalent attachment of C3b to the immune complex prevents the Fc–Fc interactions required to form large insoluble aggregates, and these small complexes bind to CR1 complement receptors on the human erythrocyte and are transported to fixed macrophages in the liver and spleen where they are safely destroyed. This is an important role of the erythrocyte, a cell often unfairly ignored in discussion of the immune system. If there are defects in this process, for example deficiencies in classical pathway components, or perhaps if the system is overloaded, then widespread disease involving deposition of complexes in the kidneys, joints, skin, and choroid plexus (networks of capillaries in the walls of the ventricles in the brain) may result.

Inflammatory lesions due to locally formed complexes

The Arthus reaction

Maurice Arthus found that injection of soluble antigen intradermally into hyperimmunized rabbits with high levels of precipitating antibody produced an erythematous and edematous reaction that reached a peak at 3–8 hours and then usually resolved. The lesion was characterized by an intense infiltration with neutrophils (Figure 14.21a,b). The injected antigen precipitates with antibody often within the venule, too fast for the classical complement system to prevent it; subsequently, the complex is able to bind complement and, using fluorescent reagents, antigen, immunoglobulin, and complement components can all be demonstrated in this lesion, as illustrated by

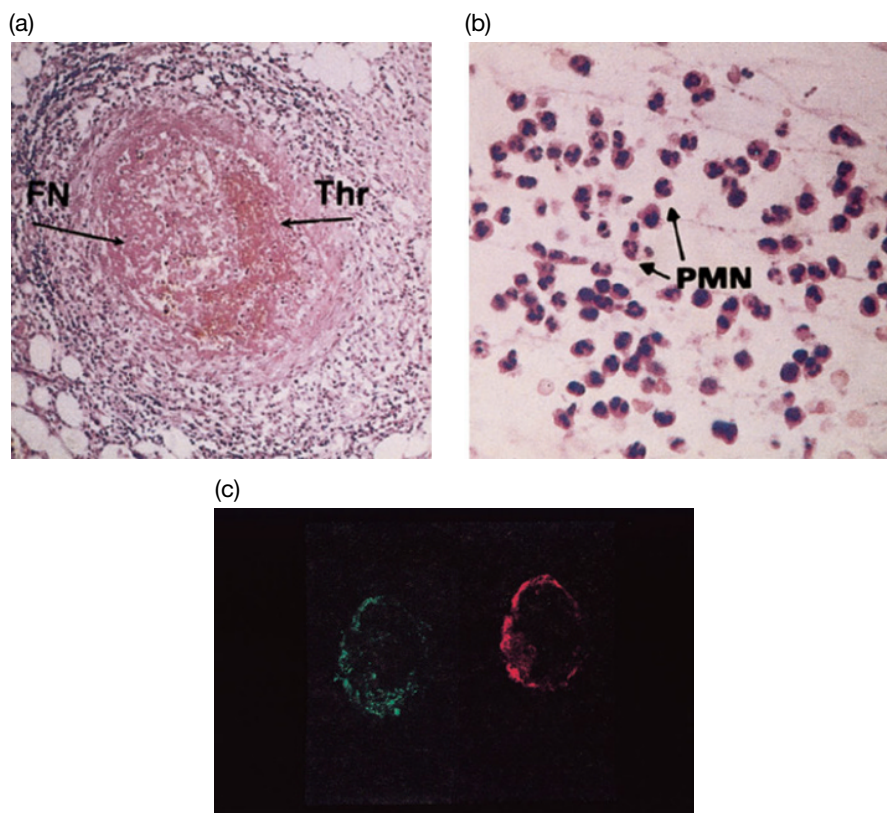


Figure 14.21 Histology of acute inflammatory reaction in polyarteritis nodosa associated with immune complex formation with hepatitis B surface antigen (HBsAg). (a) A vessel showing thrombus (Thr) formation and fibrinoid necrosis (FN) is surrounded by a mixed inflammatory infiltrate, largely neutrophils. (b) High-power view of acute inflammatory response in loose connective tissue of patient with polyarteritis nodosa; polymorphonuclear neutrophils (PMN) are prominent. (c) Immunofluorescence studies of immune complexes in the renal artery of a patient with chronic hepatitis B infection stained with fluoresceinated antihepatitis B antigen (left) and rhodaminated anti-IgM (right). The presence of both antigen and antibody in the intima and media of the arterial wall indicates the deposition of the complexes at this site. IgG and C3 deposits are also detectable with the same distribution. (Source: (a) and (b) N. Woolf. (c) A. Nowoslawski. Reproduced with permission.)

the inflammatory response to deposits of immune complexes containing hepatitis B surface antigen in a patient with periarteritis nodosa (Figure 14.21c). Anaphylatoxin (C3a, C4a, and C5a) production, mast cell degranulation, macrophage activation, platelet aggregation, and influx of neutrophils all make their contribution. The Arthus reaction can be attenuated by depletion of neutrophils by nitrogen mustard or of complement by anti-C5a; soluble forms of the complement regulatory proteins CD46 (membrane cofactor protein) and CD55 (delay accelerating factor) are also inhibitory.

Reactions to inhaled antigens

Intrapulmonary Arthus-type reactions to exogenous inhaled antigen are responsible for a number of type III hypersensitivity disorders. The severe respiratory difficulties associated with **farmer's lung** occur within 6–8 hours of exposure to the thermophilic actinomycetes that grow in the moldy hay. Inhalation of bacterial spores in dust from the hay introduces antigen into the lungs and an immune complex-mediated hypersensitivity

reaction occurs. Similar situations arise in bird-fancier's lung, where the antigens are probably avian intestinal mucin and avian IgA and IgG present in the dust from dried feces, and in many other quaintly named cases of **extrinsic allergic alveolitis** resulting from continual inhalation of organic particles, such as cheese washer's disease (*Penicillium casei* spores), furrier's lung (fox fur proteins), and maple bark stripper's disease (spores of *Cryptostroma*). Evidence that an immediate anaphylactic type I response may sometimes be of importance for the initiation of an Arthus reaction comes from the study of patients with allergic bronchopulmonary aspergillosis who have both high levels of IgE and also precipitating IgG antibodies to *Aspergillus* species.

Reactions to resident infections or to self antigens

Type III reactions are often provoked by the local release of antigen from infectious organisms within the body; for example, living filarial worms, such as *Wuchereria bancrofti*, are

relatively harmless, but the dead parasite found in lymphatic vessels initiates an inflammatory reaction thought to be responsible for the obstruction of lymph flow and the ensuing, rather monstrous, *elephantiasis*. Microbial cell death following chemotherapy may cause an abrupt release of microbial antigens and, in individuals with high antibody levels, produce

quite dramatic immune complex-mediated reactions, such as *erythema nodosum leprosum* in the skin of dapsone-treated lepromatous leprosy patients (Figure 14.22) and the Jarisch–Herxheimer reaction in syphilis patients receiving penicillin.

An interesting variant of the Arthus reaction is seen in rheumatoid arthritis, where complexes are formed locally in the joint because of the production of self-associating IgG anti-IgG by synovial plasma cells.



Figure 14.22 Erythema nodosum leprosum, forearm. The patient has lepromatous leprosy with superimposed erythema nodosum leprosum. These acutely inflamed nodules were extremely tender and the patient was pyrexial. (Source: G. Levene. Reproduced with permission.)

Disease resulting from circulating complexes

Immune complex glomerulonephritis

The deposition of complexes is a dynamic affair and long-lasting disease is only seen when the antigen is persistent, as in chronic infections and autoimmune diseases. In the glomeruli of the kidney, *small complexes reach the epithelial side*, whereas *larger complexes are retained in or on the endothelial side of the glomerular basement membrane* (Figure 14.23). They build up as “lumpy” granules containing antigen, immunoglobulin, and complement (C3) as revealed by immunofluorescence (Figure 14.19b), appearing as large amorphous masses by electron microscopy. The inflammatory process damages the basement membrane through engagement of the complexes with effector cells bearing Fc γ receptors, as illustrated by the absence of glomerulonephritis despite immune complex deposition in the kidneys of Fc γ R-knockout New Zealand (B \times W) F1 hybrids (a murine model of human

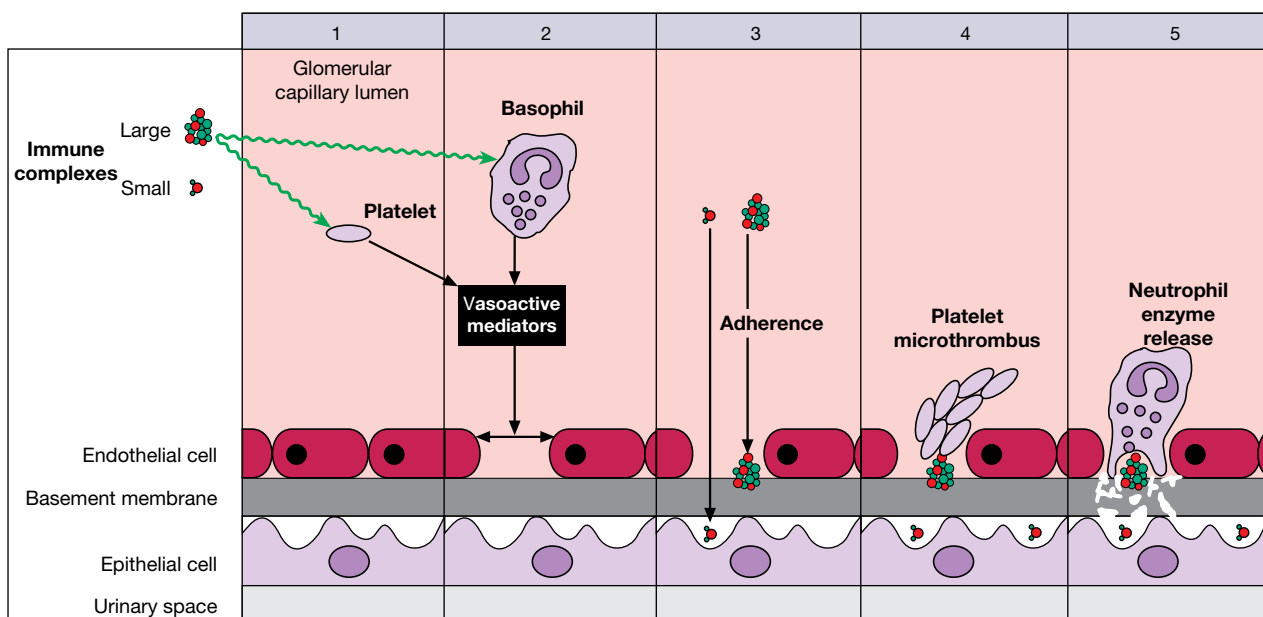


Figure 14.23 Deposition of immune complexes in the kidney glomerulus. (1) Complexes induce release of vasoactive mediators from basophils and platelets that cause (2) separation of endothelial cells. (3) Attachment of larger complexes to exposed basement membrane, with smaller complexes passing through to the epithelial side. (4) Complexes induce platelet aggregation. (5) Chemotactically attracted neutrophils release granule contents in “frustrated phagocytosis” to damage basement membrane and cause leakage of serum proteins. Complex deposition is favored in the glomerular capillary because it is a major filtration site and has a high hydrodynamic pressure. Deposition is greatly reduced in animals depleted of platelets or treated with vasoactive amine antagonists.

systemic lupus erythematosus [SLE]). Proteinuria (raised levels of protein in the urine) results from the leakage of serum proteins through the damaged membrane and serum albumin, being small, appears in the urine (Figure 14.24, lane 3).

Many cases of glomerulonephritis are associated with circulating immune complexes, and biopsies give a fluorescent staining pattern similar to that of Figure 14.19b, which depicts DNA/anti-DNA/complement deposits in the kidney of a patient with SLE. The disease that can follow infection with

certain strains of so-called “nephritogenic” streptococci and the nephrotic syndrome associated with malaria are both well-known examples where complexes with antigens of the infecting organism have been implicated. Immune complex nephritis can arise in the course of chronic viral infections; as seen in individuals co-infected with HIV and hepatitis C virus.

Deposition of immune complexes at other sites

The choroid plexuses in the brain are a major filtration site and therefore also susceptible to immune complex deposition. This factor could account for the frequency of central nervous system disorders in SLE. Neurologically affected patients tend to have depressed complement component C4 in the cerebrospinal fluid (CSF) and, at postmortem, SLE patients with neurologic disturbances and high-titer anti-DNA have been shown to have scattered deposits of immunoglobulin and DNA in the choroid plexus. Subacute sclerosing panencephalitis is associated with a high CSF-to-serum ratio of measles antibody, and deposits containing Ig and measles Ag may be found in neural tissue.

Vasculitic skin rashes are also characteristic of both systemic and discoid lupus erythematosus (Figure 14.25), and biopsies of the lesions reveal deposits of Ig and C3 at the basement membrane between the dermis and the epidermis.

Another example of immune complex hypersensitivity is the dengue hemorrhagic fever and dengue shock syndrome that can occur during a second infection with dengue virus. There are five types of virus, and antibodies to one type produced during a first infection may not neutralize a second strain but rather facilitate its entry into, and replication within, monocytes and macrophages by attachment of the complex to Fc receptors. The enhanced production of virus leads to immune complex formation and a massive intravascular activation of the classical complement pathway. In some instances

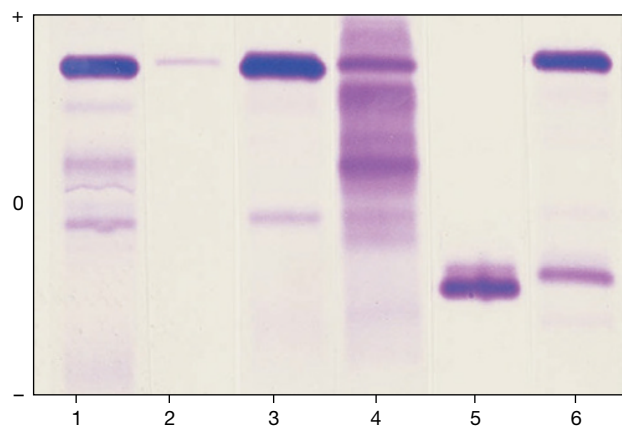


Figure 14.24 Proteinuria demonstrated by electrophoresis. Lane 1: Normal serum as reference. The major band nearest to the cathode is albumin. Lane 2: Normal urine showing a trace of albumin. Lane 3: Glomerular proteinuria showing a major albumin component. Lane 4: Proteinuria resulting from tubular damage with a totally different electrophoretic pattern. Lane 5: Bence Jones proteinuria representing excreted paraprotein light chains. Lane 6: Bence Jones proteinuria with a trace of the intact paraprotein. Some of the samples have been concentrated. (Source: T. Heys. Reproduced with permission.)

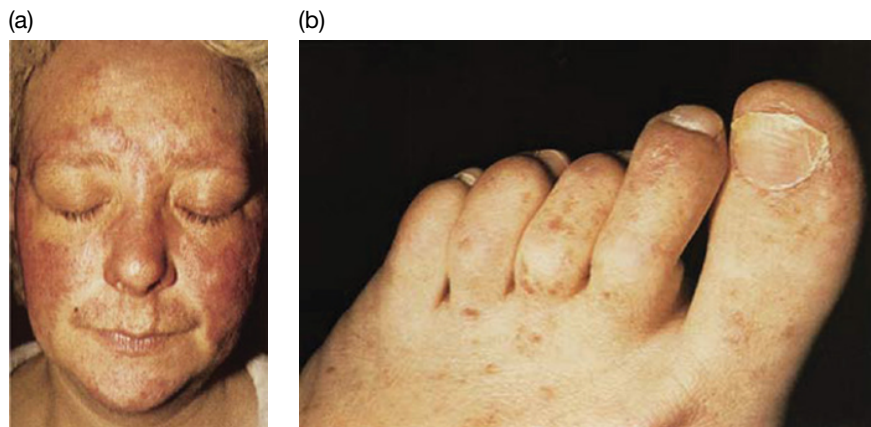


Figure 14.25 Vasculitic skin rashes caused by immune complex deposition. (a) Facial appearance in systemic lupus erythematosus (SLE). Lesions of recent onset are symmetrical, red, and edematous. They are often most pronounced on the areas of the face that receive most light exposure (i.e., the upper cheeks and bridge of the nose, and the prominences of the forehead). (b) Vasculitic lesions in SLE. Small purpuric macules are seen.

drugs such as penicillin become antigenic after conjugation with body proteins and form complexes that mediate type III hypersensitivity reactions.

Treatment

The avoidance, if at all possible, of exogenous inhaled antigens inducing type III reactions is obvious. Elimination of microorganisms associated with immune complex disease by chemotherapy may provoke a further reaction because of copious release of antigen. Sodium cromoglycate, heparin, and salicylates are often used, the latter being an effective platelet stabilizer as well as a potent anti-inflammatory agent. Corticosteroids are particularly powerful inhibitors of inflammation and are immunosuppressive. In many cases, particularly those involving autoimmunity, conventional immunosuppressive agents such as chlorambucil, cyclophosphamide, or azathioprine may be employed.

Type IV hypersensitivity – cell-mediated (delayed-type)

Unlike types I–III, which are antibody-mediated, type IV hypersensitivity is mediated by T-cells. Whereas antibody can be present in a preformed state, antigen-specific T-cells need time to proliferate, and then synthesize and secrete cytokines;

hence type IV is also referred as a “delayed-type” hypersensitivity (DTH). This kind of hypersensitivity is encountered in many allergic reactions to infectious agents, in the contact dermatitis resulting from sensitization to certain simple chemicals, and in transplant rejection. Perhaps the best-known example is the **Mantoux reaction** obtained by injection of tuberculin (an extract of *Mycobacterium tuberculosis*) into the skin of an individual in whom previous infection with the mycobacterium had induced a state of cell-mediated immunity (CMI). The reaction is characterized by erythema (redness) and induration (hardening of the tissue) (Figure 14.26a), which appears only after several hours and reaches a maximum at 24–48 hours, thereafter subsiding. Histologically, the earliest phase of the reaction is seen as a perivascular cuffing of the blood vessels with mononuclear cells followed by a more extensive exudation of mono- and polymorphonuclear cells. The latter soon migrate out of the lesion, leaving behind a predominantly mononuclear cell infiltrate consisting of lymphocytes and cells of the monocyte–macrophage series (Figure 14.26b). This contrasts with the essentially “neutrophil” character of the Arthus reaction (Figure 14.21b).

Comparable reactions to soluble proteins are obtained when sensitization is induced by incorporation of the antigen into complete Freund’s adjuvant. In some, but not all cases, if animals are primed with antigen alone or in incomplete

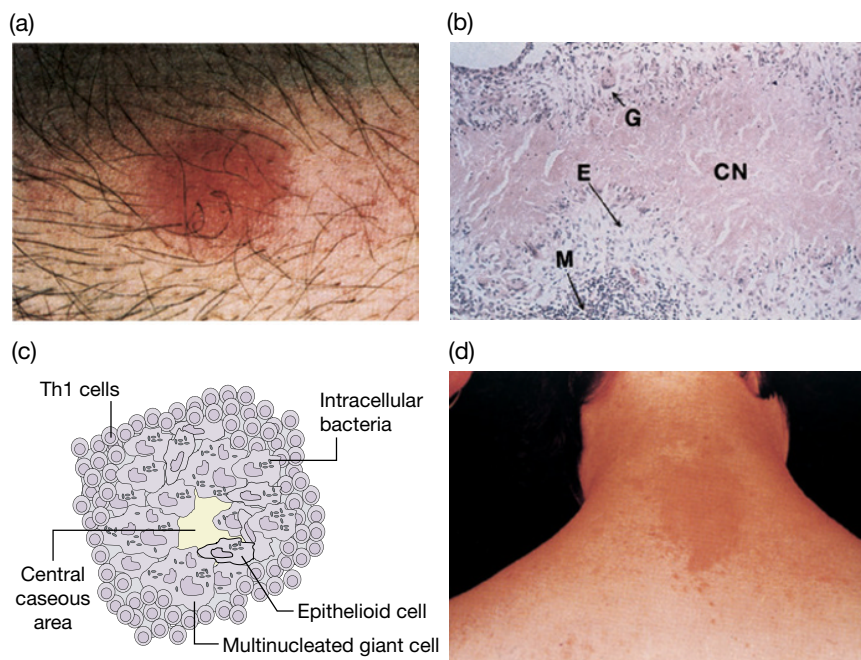


Figure 14.26 Cell-mediated (type IV) hypersensitivity reactions. (a) Mantoux test showing cell-mediated hypersensitivity reaction to tuberculin, characterized by induration and erythema. (Source: J. Brostoff. Reproduced with permission.) (b) Chronic type IV inflammatory lesion in tuberculous lung showing caseous necrosis (CN), epithelioid cells (E), giant cells (G), and mononuclear inflammatory cells (M). (Source: R. Barnetson. Reproduced with permission.) (c) Diagrammatic representation of a granuloma with central caseous (“cheesy”) necrosis. (d) Type IV contact hypersensitivity reaction to nickel caused by the clasp of a necklace. (Source: (d) British Society for Immunology. Reproduced with permission.)

Freund's adjuvant (which lacks the mycobacteria present in the complete adjuvant), the delayed hypersensitivity state is of shorter duration and the dermal response more transient. This was previously known as "Jones–Mote" sensitivity but is now usually referred to as *cutaneous basophil hypersensitivity* on account of the high proportion of basophils infiltrating the skin lesion.

The cellular basis of type IV hypersensitivity

The hypersensitivity lesion results from an exaggerated interaction between antigen and the normal cell-mediated immune mechanisms. Following earlier priming, memory T-cells recognize the antigen peptide together with MHC class II molecules on an antigen-presenting cell, such as a Langerhans cell or dermal dendritic cell, and are activated to undergo proliferation. The stimulated T-cells release a number of cytokines that mediate the ensuing hypersensitivity response, particularly by attracting and activating macrophages if they belong to the Th1 subset, or eosinophils if they are Th2. Helper T-cells also

assist Tc precursors to become killer cells that can cause damage to virally infected target cells (Figure 14.27); the CD8 TCR $\alpha\beta$ cytotoxic cells being activated by recognition of MHC class I complexes with processed viral proteins and TCR $\gamma\delta$ killers operating through binding to native viral proteins on the surface of the infected cells. Th17 cells also play a role. Thus, IL-17 knockout mice have impaired DTH responses, and IL-17A and IL-22 is secreted by nickel-specific T-cell clones from patients allergic to this allergen. Cytokines released by Th17 cells cause the activation of various cell types, including macrophages, fibroblasts, and epithelial cells that then release further proinflammatory cytokines which contribute to the pathology.

Tissue damage produced by type IV reactions

Infections

The development of cell-mediated hypersensitivity to bacterial products is probably responsible for the lesions, such as the cavitation, caseation, and general toxemia, seen in human

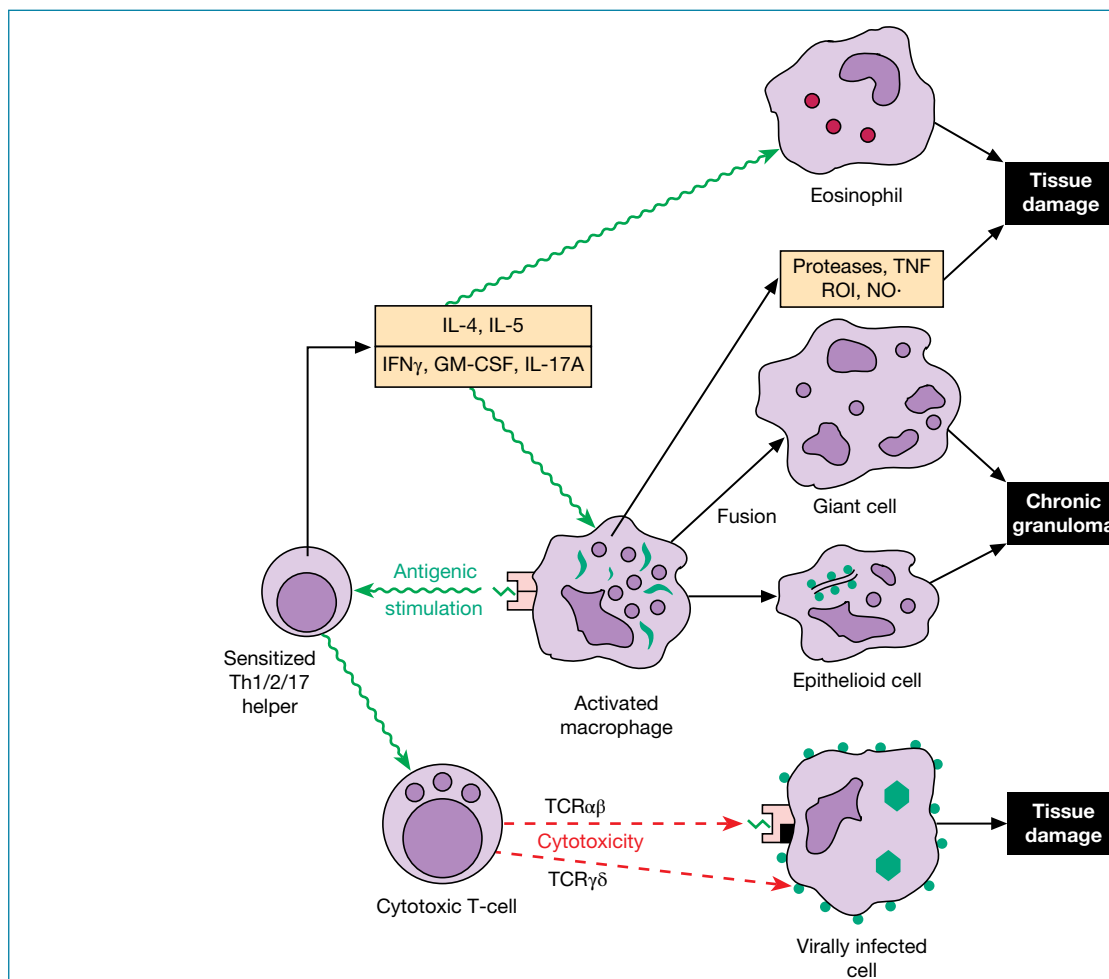


Figure 14.27 The cellular basis of type IV hypersensitivity. Th1 cells will activate macrophages and cytotoxic T-cells. IL-17A from Th17 cells is also able to activate macrophages. Th2 cells will recruit eosinophils. ROI, reactive oxygen intermediates; NO, nitric oxide.

tuberculosis and the granulomatous skin lesions found in patients with the borderline form of leprosy. When the battle between the replicating bacteria and the body defenses fails to be resolved in favor of the host, persisting antigen provokes a chronic local DTH reaction. Continual release of cytokines from sensitized T-lymphocytes leads to the accumulation of large numbers of macrophages, many of which give rise to arrays of epithelioid cells (macrophages that differentiate to morphologically resemble epithelial cells), while others fuse to form multinucleated macrophages referred to as giant cells. Macrophages presenting peptides derived from bacterial antigens using their surface MHC class I molecules may become targets for cytotoxic T-cells and be destroyed. Further tissue damage will occur as a result of indiscriminate cytotoxicity by cytokine-activated macrophages. Morphologically, this combination of cell types with proliferating lymphocytes and fibroblasts associated with areas of fibrosis and necrosis is termed a **chronic granuloma** and represents an attempt by the body to wall off a site of persistent infection (Figure 14.26b,c and Figure 14.27). It should be noted that granulomas can also arise from the persistence of indigestible antigen-antibody complexes or inorganic materials, such as talc, within macrophages, although non-immunological granulomas may be distinguished by the absence of lymphocytes.

The skin rashes in measles and the lesions associated with herpes simplex infection may be largely attributed to delayed-type reactions with extensive Tc-mediated damage to virally infected cells. By the same token, specific cytotoxic T-cells can cause extensive destruction of liver cells infected with hepatitis B virus. Cell-mediated hypersensitivity has also been demonstrated in the fungal diseases candidiasis, dermatomycosis, coccidioidomycosis and histoplasmosis, and in the parasitic disease leishmaniasis.

Inflammatory bowel disease

Crohn's disease and ulcerative colitis are the two main forms of inflammatory bowel disease (IBD) and are distinct entities, although both probably result from dysregulated mucosal immune responses to microbial antigens in the gut and involve changes to the epithelial barrier and aberrant autophagy. In **Crohn's disease** there is predominantly a Th1-like cytokine profile characterized by transmural granulomatous inflammation involving the entire bowel wall from mucosa to serosa, and the development of fibrosis, microperforations, and fistulas. Inflammation can occur throughout the gastrointestinal tract. Mutations in the *NOD2* gene, encoding a cytoplasmic pattern recognition receptor for the muramyl dipeptide of bacterial cell wall peptidoglycan, are strongly associated with susceptibility to Crohn's disease. By contrast, in **ulcerative colitis** there is a more superficial inflammation involving Th2 cells that is confined to the colon and rectum. IL-13-producing CD1d-restricted NKT cells are also present in the lamina propria.

IBD can be induced in severe combined immunodeficient (SCID) mice by the transfer of CD45RB^{hi} (naive) CD4 T-cells,

but the colitis that develops can be cured by the subsequent transfer of CD4⁺ CD25⁺ CD45RB^{lo} regulatory T-cells. The regulators secrete the suppressor cytokines TGF β and IL-10 but the balance during disease episodes is in favor of aggressor cells belonging to the IL-12-driven Th1 population and producing TNF and IFN γ . The IFN γ stimulates further production of TNF from macrophages, the latter cytokine being a key contributor to the pathology in IBD by inducing apoptosis of enterocytes. Along with IL-21, TNF also stimulates the production of matrix metalloproteinases from stromal cells. These enzymes degrade the extracellular matrix and the basement membrane, further leading to enterocyte apoptosis. Monoclonal anti-TNF is a very effective therapy. Probiotic treatment with lactobacilli and *Streptococcus salivarius* would appear to maintain remission in severe colitis, is less draconian, and is easier on the budget (remember the friendly yoghurt adverts). Clinical trials to establish the efficacy of probiotics are ongoing.

Experimental colitis induced in SJL/J mice by administration of oxazolone presents as a relatively superficial inflammation resembling human ulcerative colitis. It is initially mediated by IL-4-producing Th2 cells but rapidly superceded by an atypical Th2 response involving IL-13-producing NKT cells. The inflamed tissue in patients with ulcerative colitis has also been shown to contain increased numbers of IL-13-producing **nonclassical** NKT cells which, unlike most NKT cells, do not bear an invariant TCR. IL-13, like TNF and IL-21, contributes to apoptosis of enterocytes. Furthermore, macrophage and dendritic cell production of IL-23 drives the development of both Th17 cells and innate lymphoid cells, both of which are likely to play a role in IBD. Certainly the recruitment of neutrophils by IL-17A will add further fire to the inflammatory process.

Sarcoidosis

Sarcoidosis is a disease of unknown etiology affecting lymphoid tissue and involving the formation of chronic granulomas. A chronic inflammatory Th1 response to an infectious agent, environmental factor, or autoantigen is thought to be responsible. Evidence for an exaggerated immune response to components of mycobacteria and propionibacteria has been obtained. Patients develop a granulomatous reaction a few weeks after intradermal injection of spleen extract from another sarcoid patient – the **Kveim reaction**.

Contact dermatitis

The epidermal route of inoculation tends to favor the development of a Th1 response through processing by class II-rich dendritic Langerhans cells (see Figure 2.8f), which migrate to the lymph nodes and present antigen to T-lymphocytes. Thus, delayed-type reactions in the skin are often produced by foreign low-molecular-weight materials capable of binding to peptides within the groove of MHC molecules on the surface of Langerhans cells, to form new antigens. The reactions are characterized by a mononuclear cell infiltrate peaking at

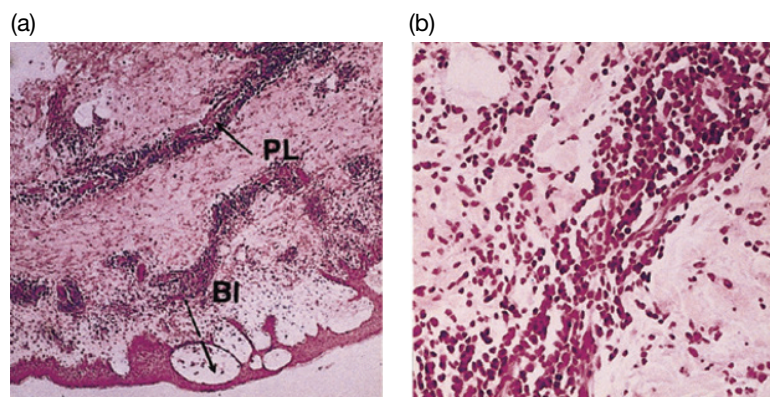


Figure 14.28 Contact sensitivity. (a) Perivascular lymphocytic infiltrates (PL) and blister (Bl) formation characterize a contact sensitivity reaction of the skin. (b) High-power view to show the lymphocytic nature of the infiltrate in a contact hypersensitivity reaction. (Source: N. Woolf. Reproduced with permission.)

12–15 hours, accompanied by edema of the epidermis with microvesicle formation (Figure 14.28). There is a most unusual twist to this story, however, possibly because the inciting reagent is a reactive hapten. The late mononuclear reaction is entirely dependent upon very early events (1–2 hours) mediated by hapten-specific IgM produced by B-1 cells that, together with complement, activates local vessels to permit T-cell recruitment. Contact hypersensitivity can occur in people who become sensitized while working with chemicals, such as picryl chloride and chromates, or who repeatedly come into contact with the substance urushiol from the poison ivy plant. *p*-Phenylene diamine in certain hair dyes, neomycin in topically applied ointments, and nickel salts formed from articles such as nickel jewellery clasps (Figure 14.26d) can provoke similar reactions. T-cell clones specific for nickel salts isolated from the latter group produce a Th1-type profile of cytokines (IFN γ , IL-2) on antigen stimulation (Figure 14.11b). Invariant NKT cells producing both the “Th1” cytokine IFN γ and the “Th2” cytokine IL-4 are also present in the skin infiltrate of patients with contact dermatitis, as are Th17 cells that secrete IL-17A and IL-23 in response to contact allergens.

Psoriasis

Psoriasis involves marked proliferation of epidermal keratinocytes and accelerated incomplete epidermal differentiation. For reasons that are not understood, in around a quarter of patients the skin manifestations are associated with *psoriatic arthritis* involving joint inflammation and destruction. The skin inflammation involves neutrophils and both CD4 and CD8 T-cells that are CD45RO⁺, indicating that they are antigen experienced. The release of IFN γ induces epidermal hyperplasia and, together with TNF, increases the expression of ICAM-1 on epidermal keratinocytes, thereby facilitating the adhesion of T-cells. Experiments in a skin xenograft model of psoriasis involving the transplantation of human skin onto SCID mice have identified that the activated form of the signal transducer

and activator of transcription 3 (STAT3) cell signaling molecule localizes to the nucleus of epidermal keratinocytes following the transfer of CD4 but not CD8 T-cells, indicating a central role for STAT3 signaling in the interactions between activated CD4 cells and keratinocytes. Biological agents that are effective in the treatment of psoriasis include etanercept (TNF receptor–IgG fusion protein) and the human monoclonal antibodies adalimumab (anti-TNF), ustekinumab (anti-IL-12 and IL-23), and secukinumab (anti-IL-17A). Efalizumab, a humanized IgG1 monoclonal antibody against CD11a (LFA-1), is also effective but was withdrawn following safety concerns. Recently, IL-22 production by Th17 cells has been shown to mediate keratinocyte proliferation and epidermal cell hyperplasia, providing another potential therapeutic target. Drugs that interfere with signaling, such as the JAK inhibitor tofacitinib, which dampens Th1 and Th17 responses, are also under investigation.

Other examples

Excessive responses by Th2 cells can damage tissues through activation of eosinophils (Figure 14.27). As recounted earlier, T-cells synthesizing IL-5 are largely responsible for the sustained influx of eosinophils in asthma and atopic dermatitis. Th2 cells also account for the liver pathology in schistosomiasis that has been attributed to a reaction against soluble enzymes derived from the eggs that lodge in the capillaries (Figure 14.29).

It has been suggested that the relatively mixed Th1–Th2 DTH response induced by bites from blood-feeding insects such as sand flies (*Phlebotomus papatasi*) might represent an adaptation of the insect to direct the host immune response to its own advantage. Thus, it was shown that the increased blood flow associated with the DTH sites allowed sand flies to feed twice as fast relative to feeding from normal skin sites.

The contribution of DTH reactions to allograft rejection is covered in Chapter 15, and the potential role of T_c cells for the control of cancer cells is discussed in Chapter 16. In certain

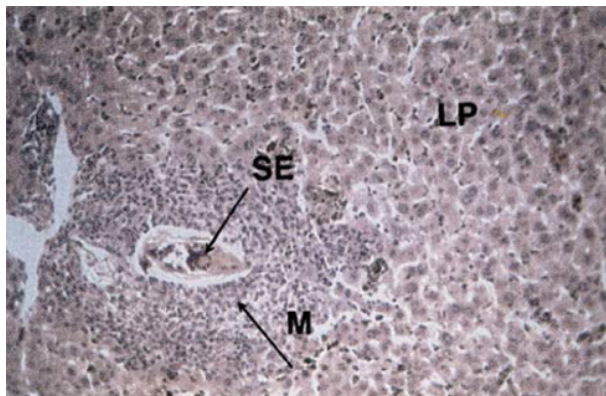


Figure 14.29 Th2-mediated response to schistosome egg. Th2-type hypersensitivity lesion of inflammatory cells (M) around a schistosome egg (SE) within the liver parenchyma (LP). (Source: M. Doenhoff. Reproduced with permission.)

organ-specific autoimmune diseases, such as type I diabetes, cell-mediated hypersensitivity reactions undoubtedly provide the major engine for tissue destruction.

The intestinal inflammation in **celiac disease**, an HLA-DQ2/8-associated enteropathy, is precipitated by exposure to dietary gliadin (a component of wheat gluten). The disorder involves what is probably a genetically related increased mucosal activity of transglutaminase (the main target antigen of anti-endomysium autoantibodies). This enzyme deamidates the glutamine residues in gliadin and creates a new T-cell epitope that binds efficiently to DQ2 and is recognized by IFN γ -secreting intraepithelial CD4⁺ Th1-cells. Local production of IL-15 also plays a role by increasing expression of non-classical MHC class I molecules such as MICA on epithelial cells and receptors for these such as NKG2D on intraepithelial CD8⁺ $\alpha\beta$ T-cells, $\gamma\delta$ T-cells, and NK cells, leading to cytotoxic killing of the epithelial cells.

An addition to the original classification – stimulatory hypersensitivity (“type V”)

Although Gell and Coombs only categorized four types of hypersensitivity reaction, a fifth type (type V) is sometimes added. This is in some ways similar to type II hypersensitivity in that it is due to antibodies to cell surface antigens, but in this case the antibodies do not mediate their effect via cytotoxicity but rather are directed to a cell surface receptor and act as an agonist leading to stimulation of the cell. When thyroid-stimulating hormone (TSH) binds to its receptor on the thyroid epithelial cells, adenylyl cyclase is activated, and the cAMP “second messenger” is generated to stimulate thyroid hormone production. Once sufficient levels of the hormones are produced, a negative feedback loop shuts off the production of TSH. The **thyroid-stimulating antibody** present in patients with Graves’ disease is an autoantibody against the

TSH receptor and mimics the effect of TSH, except in this case there is continuous secretion of the autoantibody by plasma cells that provides a constant stimulation of the thyroid leading to hyperthyroidism. Agonistic autoantibodies that stimulate the angiotensin II AT1 receptor have been described in patients with preeclampsia and with hypertension.

Innate hypersensitivity reactions

Many infections provoke a **toxic shock syndrome** characterized by hypotension (low blood pressure), hypoxia (shortage of oxygen), oliguria (decreased urine output), and microvascular abnormalities and mediated by elements of the innate immune system independently of the operation of acquired immune responses.

Sepsis (septicemia) associated with **Gram-negative bacteria** results in excessive release of TNF, IL-1 β , and IL-6 through stimulation of pattern recognition receptors on macrophages and endothelial cells by the lipopolysaccharide (LPS) endotoxin. Normally this would enhance host defenses, aiding the recruitment of phagocytes by promoting adherence to endothelium, priming neutrophils for subsequent production of reactive oxygen intermediates, inducing febrile responses (immune responses improve steadily from 33 to 44 °C), and so on. Unfortunately, the excess of circulating LPS, and the cytokines released in response to its presence, lead to unwanted pathophysiology at distant sites. This occurs in, for example, the **adult respiratory distress syndrome** brought about by an overwhelming invasion of the lung by neutrophils. There is a prolonged pathologically high concentration of nitric oxide but, additionally, LPS can activate the alternative complement pathway, and this may be linked to its ability to induce the release of thromboxane A₂ and prostaglandin from platelets, leading to **disseminated intravascular coagulation**. Whereas the major culprit in Gram-negative sepsis is LPS, **Gram-positive organisms** possess a variety of components that act on host defense elements to initiate septic shock. Thus adherence of *Staphylococcus aureus* to macrophages induces TNF synthesis, and peptidoglycan-mediated aggregation of platelets by the same organism leads to disseminated intravascular coagulation. The staphylococcal and streptococcal enterotoxins induce toxic shock syndrome by quite different means. By functioning as **superantigens**, they react directly with particular T-cell receptor families and give rise to massive cytokine release, including TNF and macrophage migration inhibitory factor (MIF).

Various treatments are under investigation, including the use of anti-TNF and IL-1Ra, but with rather limited success to date. The reader’s attention has already been drawn to both the **tumor necrosis factor receptor-associated periodic syndrome** (TRAPS) and to **paroxysmal nocturnal hemoglobinuria** in Chapter 13. Undue C3 consumption is associated with mesangiocapillary glomerulonephritis and partial lipodystrophy (degeneration of adipose tissue) in patients with the so-called **C3 nephritic factor**, an IgG autoantibody capable of

activating the alternative pathway by combining with and stabilizing the C3bBb convertase.

In patients with *idiopathic pulmonary fibrosis* there is a defective response to tissue damage in the lung with an imbalance between wound repair and fibrinolysis. TGF β and TNF production by epithelial cells and macrophages cause fibroblasts to proliferate and overproduce extracellular matrix. Anti-inflammatory agents have not generally proved of benefit in this disease. However, phase III trials of pirfenidone, a small molecule inhibitor with multiple effects including inhibition of TGF β and TNF production, have confirmed earlier studies showing that it can significantly delay disease progression.

The neuropathological hallmarks of *Alzheimer's disease* are extracellular plaques and intracellular neurofibrillary tangles. Although several genes have been linked to the development of Alzheimer's disease the strongest association found to date has been with the APOE ϵ 4 variant of the gene encoding apolipoprotein E, a cholesterol transporter. The senile plaques contain 4 kDa β -amyloid hydrophobic peptides (termed A β)

derived from β -amyloid precursor protein (APP). Normally APP is cleaved by an α -secretase into soluble products that cannot form the Alzheimer's β -amyloid fragment. However, in individuals with this neurodegenerative disease the pathogenic A β peptides are produced following sequential proteolytic processing of APP by β -secretase (BACE, β -site APP cleavage enzyme) and γ -secretase (composed of presenilin-1 and -2). Aggregated A β peptides produced by this pathway are thought to trigger apoptosis in neurons. It has been proposed that the immune system also plays a role in the development of the pathology. Thus, there is evidence that microglia respond to A β by mounting inflammatory responses which result in the release of tissue-damaging reactive oxygen species.

Although antibodies against A β and vaccines based on A β both showed promise in animal models, to date immunotherapeutic approaches to the treatment of patients with Alzheimer's disease have proved ineffective. The only drugs shown to have beneficial effects are those that modify cholinergic function and even here effects have been modest.

- Excessive stimulation of the normal effector mechanisms of the immune system can lead to tissue damage and we speak of hypersensitivity reactions, several types of which can be distinguished.

Type I hypersensitivity – IgE-mediated mast cell degranulation

- Anaphylaxis involves contraction of smooth muscle and dilatation of capillaries.
- Hayfever and asthma represent the most common atopic allergic disorders resulting from exposure to inhaled allergens. Eczema (atopic dermatitis) is also extremely common.
- Atopy stems from an excessive IgE response to antigens (allergens) that leads to local anaphylactic reactions at sites of contact with allergen.
- This depends upon the reaction of antigen with specific IgE antibody bound through its Fc to the mast cell and basophil high-affinity receptor Fc ϵ RI.
- Cross-linking and clustering of the IgE receptors activates the Lyn and Fyn protein tyrosine kinases, recruits other kinases and leads to release from the granules of mediators including histamine, leukotrienes, and platelet activating factor, plus eosinophil and neutrophil chemotactic factors and numerous other cytokines.
- Whereas the immediate reaction to allergen (maximum at 30 minutes) is due to mast cell triggering, a late phase reaction peaking at 5 hours, involving eosinophil infiltration, is initiated by the activation of macrophages through surface-bound IgE; secreted TNF and IL-1 β now act upon epithelial cells and fibroblasts to release powerful eosinophil chemoattractants such as CCL5 and CCL11.

- In asthma, serious prolongation of the response to allergen is caused by Th2 cells and ILC2 cells that sustain the recruitment of tissue-damaging eosinophils through the release of IL-5. Th17 cells promote neutrophil and macrophage responses. The soup of powerful bronchoconstrictors, the injurious effect of eosinophil major basic protein, and the mucus hypersecretion stimulated by IL-13 and IL-4 all contribute to the airway damage characteristic of chronic asthma.
- Many food allergies involve type I hypersensitivity.
- Genetic factors include linkage to a number of pattern recognition receptors, cytokines, cytokine receptors, and to HLA-DQ.
- Exposure to Th1-stimulating infections may strongly influence the "immunostat" setting of the tendency to either Th1 or Th2 responses, the latter increasing the risk of allergy through promotion of IgE synthesis and eosinophil recruitment.
- The offending antigen is identified by intradermal prick tests, giving immediate wheal and flare reactions, by provocation testing, and by measurement of allergen-specific IgE.
- Where possible, allergen avoidance is the best treatment.
- A monoclonal antibody directed to the receptor-binding domain of IgE dramatically reduces IgE levels and synthesis and decreases mast cell responsiveness.
- Symptomatic treatment involves the use of long-acting β_2 -agonists and leukotriene antagonists. Sodium cromoglycate blocks chloride channel activity, thereby stabilizing mast cells and inhibiting bronchoconstriction. Theophylline is a phosphodiesterase inhibitor that raises intracellular cAMP, causing bronchodilatation.

- Chronic asthma is dominated by activated Th2 cells and is treated with inhaled steroids that display a wide range of anti-inflammatory actions, including the ability to block the production of mediators by stimulated macrophages or Th2 cells. These are supplemented where necessary by long-acting β_2 -agonists.
- Courses of antigen injection or sublingual administration can desensitize by the formation of blocking or regulatory IgG antibodies, or through T-cell regulation.

Type II hypersensitivity – antibody-dependent cytotoxicity

- This involves the death of cells bearing antibody attached to a surface antigen.
- The cells may be taken up by phagocytic cells to which they adhere through their coating of IgG or C3b, lysed by complement or killed by ADCC effectors.
- Examples are: transfusion reactions, hemolytic disease of the fetus and newborn through rhesus incompatibility, antibody-mediated graft destruction, autoimmune reactions directed against red blood cells, platelets and kidney glomerular basement membranes, and hypersensitivity resulting from the coating of erythrocytes or platelets by a drug.

Type III hypersensitivity – immune complex-mediated

- This results from the effects of antigen–antibody complexes through: (i) activation of complement resulting in mast cell degranulation and the attraction of neutrophils, which release tissue-damaging mediators on contact with the complex; (ii) stimulation of macrophages to release proinflammatory cytokines; and (iii) aggregation of platelets to cause microthrombi and vasoactive amine release.
- Where circulating antibody levels are high, the antigen is precipitated near the site of entry into the body. The reaction in the skin is characterized by neutrophil infiltration, edema, and erythema maximal at 3–8 hours (Arthus reaction).
- Examples are farmer's lung, bird-fancier's disease, and pulmonary aspergillosis where inhaled antigens provoke high antibody levels, reactions to an abrupt increase in antigen caused by microbial cell death during chemotherapy for leprosy or syphilis, polyarteritis nodosa linked to complexes with hepatitis B virus, and an element of the synovial lesion in rheumatoid arthritis.
- In relative antigen excess, soluble complexes are formed that are removed by binding to the CR1 C3b receptors on red cells. If this system is overloaded or if the classical complement components are deficient, the complexes circulate in the free state and are deposited under circumstances of increased vascular permeability at certain preferred sites: the kidney glomerulus, the joints, the skin, and the choroid plexus.

- Examples are: glomerulonephritis associated with systemic lupus erythematosus (SLE) or infections with streptococci, malaria, and co-infection with HIV and hepatitis C virus; neurological disturbances in SLE and subacute sclerosing panencephalitis; and hemorrhagic shock in dengue viral infection.

Type IV hypersensitivity – cell-mediated (delayed-type)

- This is based upon the interaction of antigen with primed T-cells and represents tissue damage resulting from inappropriate cell-mediated immunity reactions.
- Cytokines, including $\text{IFN}\gamma$, are released that activate macrophages and account for the events that occur in a typical delayed hypersensitivity response such as the Mantoux reaction to tuberculin, that is, the delayed appearance of an indurated and erythematous reaction that reaches a maximum at 24–48 hours and is characterized histologically by infiltration with mononuclear phagocytes and lymphocytes.
- Continuing provocation of delayed hypersensitivity by persisting antigen leads to formation of chronic granulomas.
- Th2-type cells producing IL-5 can also produce tissue damage through their ability to recruit eosinophils.
- CD8 T-cells are activated by class I MHC antigens to become directly cytotoxic to target cells bearing the appropriate antigen.
- IL-22 production by Th17 cells in patients with psoriasis results in keratinocyte proliferation and epidermal cell hyperplasia.
- Examples are: tissue damage occurring in bacterial (tuberculosis, leprosy), viral (measles, herpes), fungal (candidiasis, histoplasmosis), and parasitic (leishmaniasis, schistosomiasis) infections, contact dermatitis from exposure to chromates and poison ivy, insect bites, and psoriasis. Inflammatory bowel disease can result from Th1-type (Crohn's disease) or "Th2-like" NKT (ulcerative colitis) reactions to intestinal bacteria. Celiac disease is an aberrant response to wheat gliadin.

Stimulatory hypersensitivity (type V)

- The antibody reacts with a key surface component such as a hormone receptor and "switches on" the cell.
- An example is the hyperthyroidism in Graves' disease due to a stimulatory anti-TSHR autoantibody. Features of these five types of acquired hypersensitivity are compared in Table 14.4.

Innate hypersensitivity reactions

- Some infections provoke a "toxic shock syndrome" involving excessive release of TNF, IL- 1β , and IL-6 and activation of the alternative complement pathway.
- Acute respiratory distress syndrome associated with Gram-negative bacteria is primarily due to the

Table 14.4 Comparison of the main types of hypersensitivity involving acquired responses.

		Anaphylactic (I)	Cytotoxic (II)	Complex-mediated (III)	Cell-mediated (IV)	Stimulatory (V)
Antibody mediating the reaction		Homocytotropic Ab	Humoral Ab	Humoral Ab	None	Humoral Ab
		Mast-cell binding	±CF*	±CF*	(T-cell mediated)	Non-CF*
Antigen		Usually exogenous (e.g., grass pollen)	Cell surface	Extracellular	Associated with MHC on macrophage or target cell	Cell surface
Response to intradermal antigen:	Max. reaction	30 min (+late reaction)	–	3–8 h	24–48 h	–
	Appearance	Wheal and flare	–	Erythema and edema	Erythema and induration	–
	Histology	Degranulated mast cells; edema; (late reaction cellular including eosinophils)	–	Acute inflammatory reaction; predominant neutrophils	Perivascular inflammation: polymorphs migrate out leaving predominantly mononuclear cells	–
Transfer sensitivity to normal subject			Serum antibody		Lymphoid cells	Serum antibody
Examples:		Atopic allergy, e.g., hay fever	Hemolytic disease of the fetus & newborn (Rh)	Immune complex glomerulonephritis Farmer's lung	Mantoux reaction to TB Granulomatous reaction to TB Contact sensitivity	Graves' disease

* CF, complement fixation.

- lipopolysaccharide (LPS) endotoxin provoking a massive invasion of the lung by neutrophils.
- Gram-positive organisms cause release of TNF and macrophage migration inhibitory factor (MIF) through direct action on macrophages and stimulation of selected T-cell families by the enterotoxin superantigens.
- Aberration of innate mechanisms may underlie idiopathic pulmonary fibrosis.
- A role for innate responses has been proposed as a contributory factor to the pathogenesis of Alzheimer's disease.



Now visit www.roitt.com to test yourself on this chapter.

FURTHER READING

- Alcorn J.F., Crowe C.R., and Kolls J.K. (2010) T_H17 cells in asthma and COPD. *Annual Review of Physiology* **72**, 495–516.
- Berlin M.C. and Sampson H.A. (2013) Food allergy: an enigmatic epidemic. *Trends in Immunology* **34**, 390–397.
- Chapel H., Haeney M., Misbah S., and Snowden N. (2014) *Essentials of Clinical Immunology*, 6th edn. Blackwell Publishing, Oxford.
- Frew A.J. (2008) Sublingual immunotherapy. *New England Journal of Medicine* **358**, 2259–2264.
- Holgate S.T., Church M.K., Broide D.H., and Martinez F.D. (2011) *Allergy*, 4th edn. Saunders, London.
- Licona-Limón P., Kim L.K., Palm N.W., and Flavell R.A. (2013) T_H2 , allergy and group 2 innate lymphoid cells. *Nature Immunology* **14**, 536–542.
- Martinez F.D. and Vercelli D. (2013) Asthma. *Lancet* **382**, 1360–1372.
- Moran T.P., Vickery B.P., and Burks A.W. (2013) Oral and sublingual immunotherapy for food allergy: current progress

- and future directions. *Current Opinion in Immunology* **25**, 781–787.
- Otsuka A., Nonomura Y., and Kabashima K. (2016) Roles of basophils and mast cells in cutaneous inflammation. *Seminars in Immunopathology* **38**, 563–570.
- Palomares O., Yaman G., Azkur A.K., Akkoc T., Akdis M., and Akdis C.A. (2010) Role of Treg in immune regulation of allergic diseases. *European Journal of Immunology* **40**, 1232–1240.
- Peloquin J.M., Goel G., Villablanca E.J., and Xavier R.J. (2016) Mechanisms of Pediatric Inflammatory Bowel Disease. *Annual Review of Immunology* **34**, 31–64.
- Rothenberg M.E. and Hogon S.P. (2006) The eosinophil. *Annual Review of Immunology* **24**, 147–174.
- Torgerson D.G., Ampleford E.J., Chiu G.Y., *et al.* (2011) Meta-analysis of genome-wide association studies of asthma in ethnically diverse North American populations. *Nature Genetics* **43**, 887–892.
- Valenta R., Ferreira F., Focke-Tejkl M., *et al.* (2010) From allergen genes to allergy vaccines. *Annual Review of Immunology* **28**, 211–241.
- Wesemann D.R. and Nagler C.R. (2016) The Microbiome, Timing, and Barrier Function in the Context of Allergic Disease. *Immunity* **44**, 728–738.
- Wolter S. and Price H.N. (2014) Atopic dermatitis. *Pediatric Clinics of North America* **61**, 241–260.

CHAPTER 15

Transplantation

Key topics

■ Types of graft	436
■ Types of rejection	436
■ Genetic control of transplantation antigens	437
■ Some other consequences of MHC incompatibility	438
■ Mechanisms of graft rejection	439
■ Matching the donor and recipient	442
■ Immunosuppression	445
■ Is xenografting a practical proposition?	449
■ Stem cell therapy	449
■ Clinical experience in grafting	450
■ The fetus as an allograft	454

Just to recap ...

Although the cells of the innate response and the B-lymphocytes of the adaptive response recognize intact antigen, T-lymphocytes recognize processed antigens in the form of peptides presented by cell surface MHC molecules. At the population level there is an incredible diversity of MHC genes that is thought to have evolved in response to pathogen diversity. The V(D)J recombination mechanisms associated with antibodies and T-cell receptors have the potential to generate responses against virtually any foreign antigen, including allogeneic MHC molecules.

Introduction

The replacement of diseased organs by a transplant of healthy tissue has long been an objective in medicine but has been frustrated to no small degree by the uncooperative attempts by the body to reject grafts from other individuals. Unfortunately, a relatively high percentage of T-cells have T-cell receptors specific for “allo-MHC” (i.e., the MHC variants of other individuals). Furthermore, antibodies can be produced against nonself antigens on transplanted tissues or organs. These constraints necessitate both tissue type matching and immunosuppression in most cases of transplantation from genetically non-identical individuals.

Types of graft

First, let us define the terms used for transplants between individuals and species:

- *Autograft* – tissue grafted back on to the original donor.
- *Isograft* – graft between **syngeneic** individuals (i.e., of identical genetic constitution) such as identical twins or mice of the same pure inbred strain.
- *Allograft* – graft between **allogeneic** individuals (i.e., members of the same species but different genetic constitution), for example, human to human and one mouse strain to another.
- *Xenograft* – graft between **xenogeneic** individuals (i.e., of different species), for example, pig to human.

Most types of clinical transplant (Table 15.1) involve allografts, although there is now a serious interest in the use of grafts from other species. The most common allografting procedure is blood transfusion, where the unfortunate consequences of mismatching include hemolysis (lysis of red cells), intravascular coagulation, chills, and nausea. However, such events are rare because infused blood would, of course, normally have been cross-matched for the ABO and Rh blood groups.

Considerable attention has been paid to the rejection of solid grafts, such as skin, and the sequence of events is worth describing. In mice, for example, the skin allograft settles down and becomes vascularized within a few days. Between 3 and 9 days the circulation gradually diminishes and there is increasing infiltration of the graft bed with lymphocytes and monocytes. Necrosis begins to be visible macroscopically and

Table 15.1 The major transplanted organs and tissues.

Organ/tissue	Deceased donor	Living donor
Blood	–	14 million units
Skin	–	48000
Cornea	47000	–
Hematopoietic stem cells	–	18000
Kidney	11161	5732
Liver	6203	252
Heart	2531	–
Lung	1922	1
Kidney/pancreas	761	1
Pancreas	256	–
Intestine	108	1
Heart/lung	23	

The numbers reflect transplants carried out in the United States in 2013, and for blood, skin, cornea, and hematopoietic stem cells are approximate. Skin grafts were mostly autologous. Hematopoietic stem cells were derived from bone marrow, peripheral blood, or cord blood and 60% were autologous.
Data source: OPTN (optn.transplant.hrsa.gov) 2014.

within a day or so the graft is sloughed completely (Figure M15.1.1). **Rejection is an immunological phenomenon**, showing both memory and specificity (Milestone 15.1). Furthermore, the recipient of T-cells from a donor who has already rejected a graft will give accelerated rejection of a further graft of the same type (Figure 15.1), showing that the lymphoid cells are primed and retain memory of the first contact with graft antigens.

Types of rejection

Various immunological mechanisms can contribute to rejection, which can occur immediately after transplantation or may take longer to manifest itself. The three main types of rejection based on the time course of their development are:

- **Hyperacute rejection** – occurring within minutes of transplantation and resulting from pre-existing anti-donor antibodies in the recipient binding to blood vessel endothelium in the donated organ.
- **Acute rejection** – taking place days or weeks following transplantation and mediated by lymphocytes.
- **Chronic rejection** – taking months or years to manifest itself and involving mechanisms that are often somewhat poorly defined.

The features of these different types of rejection are summarized in Table 15.2. Both hyperacute and acute rejection are becoming less common due to careful matching between the donor and recipient and improved immunosuppressive regimens. Chronic rejection, however, remains a substantial problem. Patient survival

is very often longer than graft survival, with large numbers of transplant recipients eventually needing a new graft. Unfortunately, repeat grafts tend to have shorter survival times.

Genetic control of transplantation antigens

The specificity of the antigens involved in graft rejection is under genetic control. Genetically identical individuals, such as mice of a pure strain or monozygotic twins, have identical

transplantation antigens and grafts can be freely exchanged between them. The mendelian segregation of the genes controlling these antigens has been revealed by interbreeding experiments between mice of different pure strains. As these mice breed true within a given strain and always accept grafts from each other, they must be homozygous for the “transplantation” genes. Consider two such strains A and B with allelic genes differing at one locus. In each case paternal and maternal genes will be identical and they will have a genetic constitution of, say, A/A and B/B respectively. Crossing strains A and B gives



Milestone 15.1 The immunological basis of graft rejection

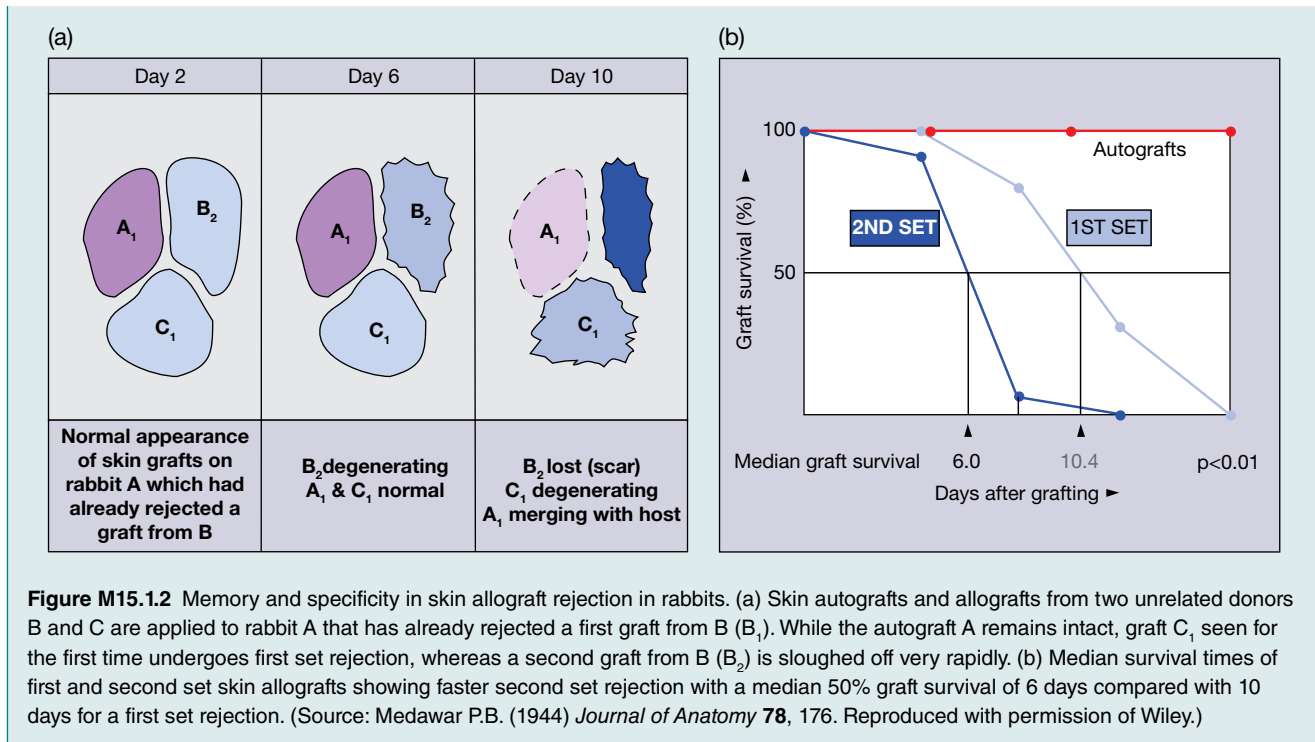
The field of transplantation owes a tremendous debt to Sir Peter Medawar, the outstanding scientist who kick-started and inspired its development. Even at the turn of the twentieth century it was an accepted paradigm that grafts between unrelated members of a species would be unceremoniously rejected after a brief initial period of acceptance (Figure M15.1.1). That there was an underlying genetic basis for rejection became apparent from Padgett's observations in Kansas City in 1932 that skin allografts between family members tended to survive for longer than those between unrelated individuals and James Barrett Brown's critical demonstration in St. Louis in 1937 that monozygotic (i.e., genetically identical) twins accepted skin grafts from each other. However, it was not until Medawar's research in the early part of the Second World War, motivated by the need to treat aircrew with appalling burns, that rejection was laid at immunology's door. He showed that a second graft from a given donor was rejected more rapidly and more vigorously than the first and, further, that an unrelated graft was rejected with the kinetics of a first set reaction (Figure M15.1.2). This **second set rejection** is characterized by **memory** and **specificity** and thereby bears the hallmarks of an immunological response. This was later confirmed by transferring the ability to express a second set reaction with lymphocytes.

The message was clear: to achieve successful transplantation of tissues and organs in the human, it would be necessary to overcome this immunogenetic barrier. Limited success was obtained by Joseph Murray at the Peter Bent Brigham Hospital (Boston) and Jean Hamburger in Paris, who grafted kidneys between dizygotic twins using sublethal X-irradiation. The key breakthrough came when Robert Schwartz and William Damashek's report on the immunosuppressive effects of the antimetabolic drug 6-mercaptopurine was applied independently by Roy Calne and Charles Zukowski in 1960 to the prolongation of renal allografts in dogs. This finding was followed very rapidly by Murray's successful grafting in 1962 of an unrelated cadaveric kidney under the immunosuppressive umbrella of azathioprine, the more effective derivative of 6-mercaptopurine devised by George Hutchings and Gertrude Elion.

This story is studded with Nobel Prize winners and readers of a historical bent will gain further insight into the development of this field and the minds of the scientists who gave medicine this wonderful prize in Hakim N.S. and Papalouis V. (eds.) (2003) *History of Organ and Cell Transplantation*, Imperial College Press, London and in Brent L. (1996) *A History of Transplantation Immunology*, Academic Press, London.



Figure M15.1.1 Appearance of skin grafts in mice. (a) Graft undergoing rejection; (b) complete rejection (scab); and, for comparison, (c) a completely healed skin graft without evidence of rejection. (Source: McFarland H.I. and Rosenberg A.S. *Current Protocols in Immunology*. Unit Number: UNIT 4.4. Reproduced with permission of Wiley.)




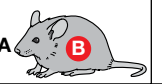




Previously grafted strain A mouse	Transfer T-cells	Naive strain A mouse	Rejection
	→		2nd set
	→		1st set
	→		1st set

Figure 15.1 Graft rejection induces memory that is specific and can be transferred by T-cells. In experiment 1, an A strain recipient of T-cells from another A strain mouse, which had previously rejected a graft from strain B, will give accelerated (i.e., second set) rejection of a B graft. This occurs even though the mouse that has received the graft has not itself previously been grafted. Experiments 2 and 3 show the specificity of the phenomenon with respect to the genetically unrelated third party strain C.

a first familial generation (F1) of constitution A/B . Now, all F1 mice accept grafts from either parent, showing that they are immunologically tolerant to both A and B due to the fact that the transplantation antigens from each parent are co-dominantly expressed (see Figure 4.28). By intercrossing the F1 generation, one would expect an average distribution of genotypes for the F2s as shown in Figure 15.2; only one in four would have no A genes and would therefore reject an A graft because of

lack of tolerance, and one in four would reject B grafts for the same reason. Thus, for each locus, three out of four of the F2 generation will accept parental strain grafts.

In the mouse around 40 such loci have been established but, as we have seen earlier, the complex set of loci termed H-2 (HLA in the human) predominates in the sense that it controls the “strong” transplantation antigens that provoke intense allograft reactions. We have looked at the structure (see Figure 4.19) and biology of this *major histocompatibility complex* (MHC) in some detail in previous chapters (see Milestone 4.2). Given the mendelian segregation and co-dominant expression of these genes, it should be evident that in outbred populations siblings have a 1 : 4 chance of identity with respect to MHC. The non-H-2 or “minor” transplantation antigens, such as the male H-Y, are recognized by T-cells as processed peptides in association with the MHC molecules. One should not be misled by the term “minor” into thinking that these antigens cannot give rise to serious rejection problems; they do, albeit more slowly than the MHC.

Some other consequences of MHC incompatibility

Class II MHC differences produce a mixed lymphocyte reaction (MLR)

When peripheral blood mononuclear cells (PBMCs) from individuals of different class II haplotype are cultured together, lymphocyte activation and proliferation occurs (MLR), the T-cells of each population reacting against MHC class II determinants on the surface of the cells of the other

Table 15.2 The various types of graft rejection.

Graft rejection	Time course	Cause	Characteristics
Hyperacute	Minutes	Pre-existing antibodies due to either blood group incompatibility or presensitization to class I MHC through blood transfusion	Antibodies bind to blood vessel endothelium in the graft, resulting in complement activation, neutrophil recruitment, platelet aggregation, and blood clotting
Acute	Several days	Activation of lymphocytes	Cytotoxic T-cells attack the donor cells expressing foreign MHC. Helper T-cells and B-cells collaborate in production of antibodies to alloantigens
Chronic	Months to years	Multiple immune mechanisms or recurrence of the original disease	Mechanisms not fully understood. Can involve lymphocytes, phagocytes, antibody and complement

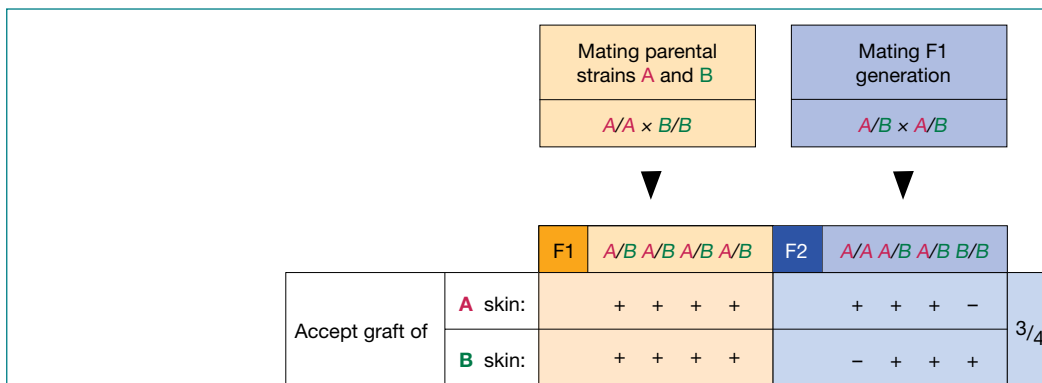


Figure 15.2 Inheritance of genes controlling transplantation antigens. A represents a gene expressing the A antigen and B the corresponding allelic gene at the same genetic locus. The pure strains are homozygous for A/A and B/B respectively. As the genes are co-dominant, an animal with A/B genome will express both antigens, become tolerant to them and therefore accept grafts from either A or B donors. The illustration shows that, for each gene controlling a transplantation antigen specificity, three-quarters of the F2 generation will accept a graft of parental skin. For n genes the fraction is $(3/4)^n$. If F1 A/B animals are back-crossed with an A/A parent, half the progeny will be A/A and half A/B; only the latter will accept B grafts.

population. The responding cells are predominantly CD4⁺ T-cells and are stimulated by the class II determinants present mostly on B-cells, macrophages, and especially dendritic cells. Thus, the MLR is inhibited by antisera to class II determinants on the stimulator cells.

The graft-versus-host (GVH) reaction

When competent T-cells are transferred from a donor to a recipient who is incapable of rejecting them, the grafted cells survive and have time to recognize the host antigens and react immunologically against them. Instead of the normal transplantation reaction of host against graft, we have the reverse, a graft-versus-host (GVH) reaction (Figure 15.3). In the young rodent there can be inhibition of growth (runt-ing), spleen enlargement, and hemolytic anemia (due to the production of red cell antibodies). In the human, fever, anemia, weight loss, rash, diarrhea, and splenomegaly are observed, with cytokines, especially tumor necrosis factor (TNF), being major mediators of pathology. The “stronger” the transplantation antigen difference, the more severe the reaction. Where donor and recipient differ at HLA or H-2

loci, the consequences can be fatal, although it should be noted that reactions to dominant minor transplantation antigens, or combinations of them, may be equally difficult to control.

In humans, a GVH reaction may arise in immunologically compromised subjects receiving hematopoietic stem cell grafts (e.g., for severe combined immunodeficiency) or as a form of cancer therapy. Competent T-cells in blood or present in grafted organs given to immunosuppressed patients may also mediate GVH reactions.

Mechanisms of graft rejection

Various immune system components can mediate an attack upon the foreign organ or tissue and thereby contribute towards rejection.

Lymphocytes can mediate rejection

A primary role of lymphocytes in first set rejection is consistent with the histology of the early reaction showing infiltration by mononuclear cells with very few polymorphonuclear cells or

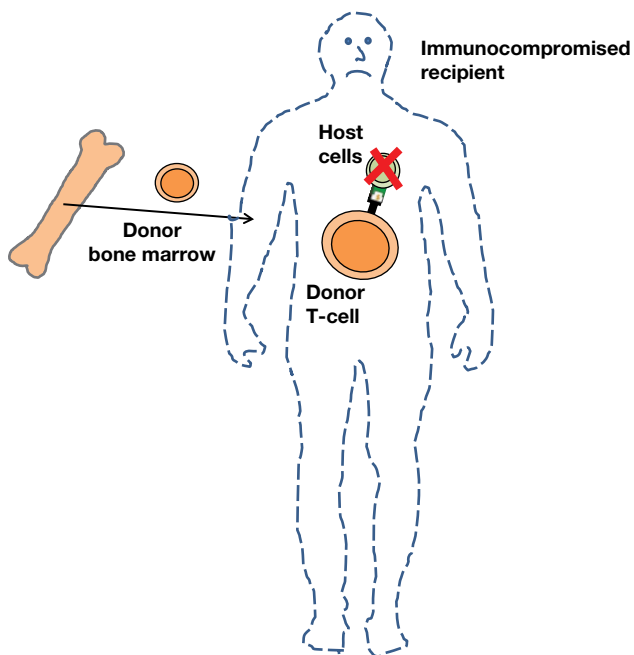


Figure 15.3 Graft-versus-host reaction. When immunocompetent T-cells are inoculated into a host incapable of reacting against them, the grafted cells are free to react against the foreign antigens on the host's cells. The ensuing reaction may be fatal.

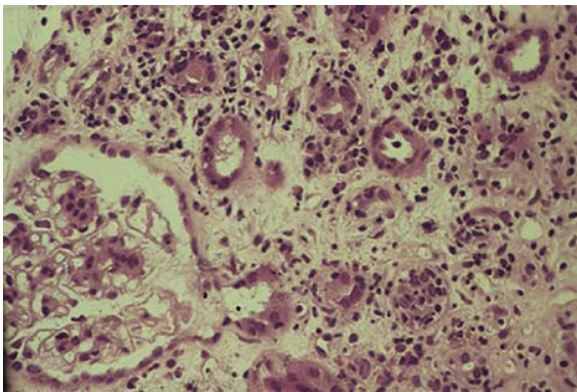


Figure 15.4 Acute rejection of human renal allograft showing dense cellular infiltration of interstitium by mononuclear cells. (Source: M. Thompson and A. Dorling. Reproduced with permission.)

plasma cells (Figure 15.4). The dramatic effect of neonatal thymectomy on prolonging skin transplants, and the long survival of grafts in children with thymic deficiencies, implicate the T-cells in these reactions. In the chicken, allograft rejection and GVH reactivity are influenced by neonatal thymectomy but not bursectomy. More direct evidence has come from *in vitro* studies showing that T-cells taken from mice rejecting an allograft could kill target cells bearing the graft antigens

in vitro. Although CD8 cytotoxic T-cells play a major role in allograft rejection, a number of murine models have indicated that in the absence of CD4 T-cells allografts can be accepted indefinitely. Indeed, rejection can be mediated by CD4 T-cells in the absence of CD8 T-cells, perhaps because the CD4 cells sometimes have cytotoxic potential for class II targets. However, in intact animals, cytokine secretion from CD4 T-cells will recruit and activate CD8 T-cells, B-cells, NKT cells, and macrophages that all have the potential to contribute to the rejection process. Furthermore, interferon- γ (IFN γ) upregulates MHC expression on the target graft cell, so increasing its vulnerability to CD8 cytotoxic cells.

Recognition of allogeneic MHC by the recipient's T-cells

Remember, we defined the MHC by its ability to provoke the most powerful rejection of grafts between members of the same species. This intensity of MHC-mismatched rejection is a consequence of the **very high frequency of alloreactive T-cells** (i.e., cells that react with allografts) **present in normal individuals**. Whereas merely a fraction of a percent of the normal T-cell population is specific for a given single peptide, upwards of 10% of T-cells react with alloantigens. Two main pathways of recognition have been described. In the **direct pathway** large numbers of recipient alloreactive T-cells recognize **allo-(i.e., graft) MHC** on the surface of donor cells, whereas in the **indirect pathway** a smaller number of recipient T-cells recognize peptides derived from **allo-MHC** (and allo-minor transplantation antigens) presented by self MHC molecules on the recipient's own antigen-presenting cells (Figure 15.5a,b).

Allogeneic MHC differs from the recipient essentially in the groove residues that contact processed peptide, but much less so in the more conserved helical regions that are recognized by the TCR. Having a different groove structure, the allo-MHC will be able to bind a number of peptides derived from proteins common to donor and host that might be unable to fit the groove in the host MHC and therefore fail to induce self-tolerance. Thus the host T-cells that recognize allo-MHC plus common peptides will not have been eliminated, and will be available to react with the large number of different peptides binding to the allo-groove of the donor antigen-presenting cells (APCs) that migrate to the secondary lymphoid tissue of the graft recipient. In some cases, the polymorphic residues may lie within the regions of the MHC helices that contact TCR directly and, by chance, a proportion of the T-cell repertoire cross-reacts and binds to the donor MHC with high affinity. Attachment of the T-cell to the APC will be particularly strong as the TCRs will bind to all the donor MHC molecules on the APC, whereas in the case of normal MHC-peptide recognition, only a small proportion of the MHC grooves will be filled by the specific peptide in question. These direct pathways of immunization by the allograft MHC that are usually initiated by the most powerful APC, the dendritic cell, dominate

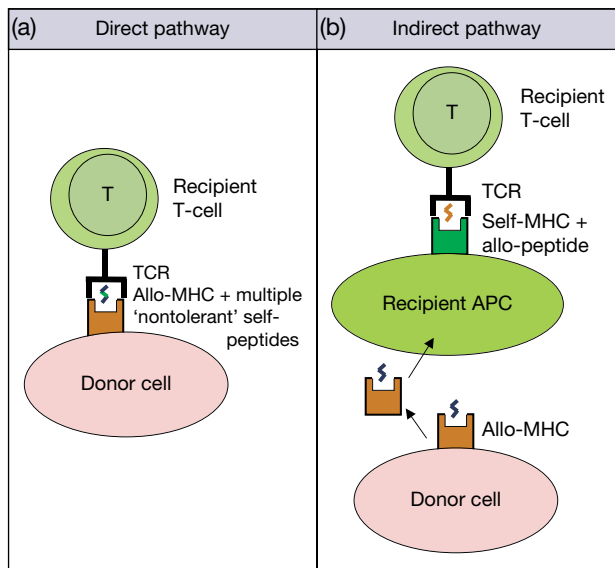


Figure 15.5 Recognition of graft antigens by alloreactive T-cells. (a) Direct pathway. T-cell receptors (TCR) on the recipient's T-cells directly recognize allogeneic MHC (brown) on the surface of donor antigen-presenting cells (APC). Polymorphic differences between MHC allotypes largely affect peptide binding rather than TCR contact by the donor MHC. Under these circumstances, the donor allogeneic MHC molecule will be seen as similar to "self" MHC by the recipient's T-cells but, unlike the self MHC, the donor MHC groove on graft APCs will bind large numbers of processed peptides common to graft and recipient to which the responder host T-cells have not been rendered tolerant and that can therefore provoke a reaction in up to 10% of these host T-cells. This provides the intensity of the allograft response. This explanation for the high frequency of alloreactive T-cells is given further credibility by the isolation of individual T-cell clones that react with self and allo-MHC, each binding a different peptide sequence. Direct recognition of donor MHC by recipient T-cells can also occur if the limited polymorphism in the α -helix adventitiously allows binding of TCRs to the allo-MHC independently of the associated peptide. Multiple bonds of this nature between the APC and T-cell may give rise to a strong enough interaction to permit T-cell activation. (b) Indirect pathway. The recipient's APCs process donor MHC (brown) and donor minor histocompatibility molecules and, just as they would any protein molecule, then present the generated allogeneic peptides (brown) using their own (i.e., self) MHC (green). The initially small population of T-cells that are stimulated by the indirect pathway will expand with time.

the early sensitization events, as this acute phase of rejection can be blocked by antibodies to the allo-MHC class II.

However, with time, as the donor APCs in the graft are replaced by recipient cells, the indirect pathway of sensitization involving the presentation of processed **allogeneic peptides** by **host MHC** (Figure 15.5b) can become involved. Although T-cells recognizing peptides derived from polymorphic graft proteins would be expected to be present at low frequency comparable to that observed with any foreign

antigen, a graft that has been in place for an extended period will have the time to expand this small population significantly, so that later rejection may depend progressively on this indirect pathway. In these circumstances, anti-recipient MHC class II can now be shown to prolong renal allografts in rats.

The role of antibody

Allogeneic cells can be destroyed by antibody-mediated cytotoxic (type II hypersensitivity) reactions. Consideration of the different ways in which kidney allografts can be rejected illustrates the contribution of antibody to the rejection process.

In hyperacute rejection the antibodies that bind to blood vessel endothelium in the donated kidney activate the classical pathway of complement and initiate the blood clotting cascade. The blood vessels become blocked with aggregated platelets, and neutrophils are also rapidly recruited as a result of the complement activation.

Acute rejection of a kidney is characterized by dense cellular infiltration (Figure 15.4) and rupture of peritubular capillaries. CD8⁺ cytotoxic T-cells attack the graft cells whose MHC antigen expression has been upregulated by IFN γ . CD4⁺ T-cells are also present, including cells of the Th17 phenotype. Upregulated expression of the CD80 and CD86 co-stimulatory molecules occurs on tubular epithelial cells, thereby promoting activation of these cell-mediated responses, further aided by the local production of a number of chemokines. Although some T-cells may become sensitized within the graft itself, antigen presentation by dendritic cells of both donor and recipient origin occurs predominantly in the draining lymph nodes. Acute humoral rejection involving anti-donor MHC can contribute to acute rejection episodes. Binding of graft-specific antibody leads to the deposition of substantial amounts of complement component C4d in the peritubular capillaries. Immunoglobulin deposits on the vessel walls induce platelet aggregation in the glomerular capillaries, leading to acute renal shutdown (Figure 15.6). The possibility of damage to antibody-coated cells through antibody-dependent cellular cytotoxicity (ADCC) must also be considered.

Chronic rejection involves glomerular and tubular fibrosis and is often associated with subendothelial deposits of immunoglobulin and C4d in the glomerular and peritubular capillaries. This may sometimes be an expression of an ongoing immune complex disorder (causing the renal pathology that originally resulted in the necessity to replace a damaged kidney) or possibly of complex formation with soluble antigens derived from the grafted kidney.

The complexity of the action and interaction of cellular and humoral factors in graft rejection is therefore considerable and an attempt to summarize the postulated mechanisms involved is presented in Figure 15.7.

There are also circumstances when antibodies may actually protect a graft from destruction, a phenomenon termed enhancement.

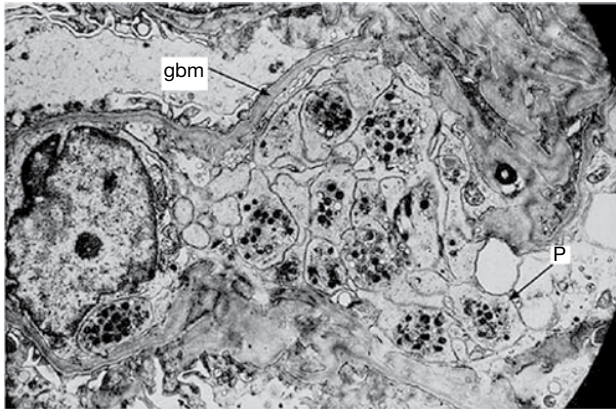


Figure 15.6 Acute late rejection of human renal allograft showing platelet aggregation in a glomerular capillary induced by deposition of antibody on the vessel wall. Electron micrograph. gbm, glomerular basement membrane; P, platelet. (Source: K. Porter. Reproduced with permission.)

Matching the donor and recipient

Given the fact that demand for transplantation far outstrips the supply of available organs (Figure 15.8) it is essential to maximize the chances that the graft will be immunologically accepted by the recipient. As MHC differences provoke the most vicious rejection of grafts, a prodigious amount of effort has gone into defining these antigen specificities, in an attempt to minimize rejection by matching graft and recipient in much the same way that individuals are cross-matched for blood transfusions (incidentally, the ABO group provides strong transplantation antigens).

HLA tissue typing

HLA alleles are defined by their gene sequences and individuals can be typed by the polymerase chain reaction (PCR) using discriminating pairs of primers. Molecules encoded by the class II *HLA-DP*, *-DQ*, and *-DR* loci provoke CD4 T-cell responses, whereas *HLA-A*, *-B*, and *-C* gene products are targets for alloreactive CD8 T-cells.

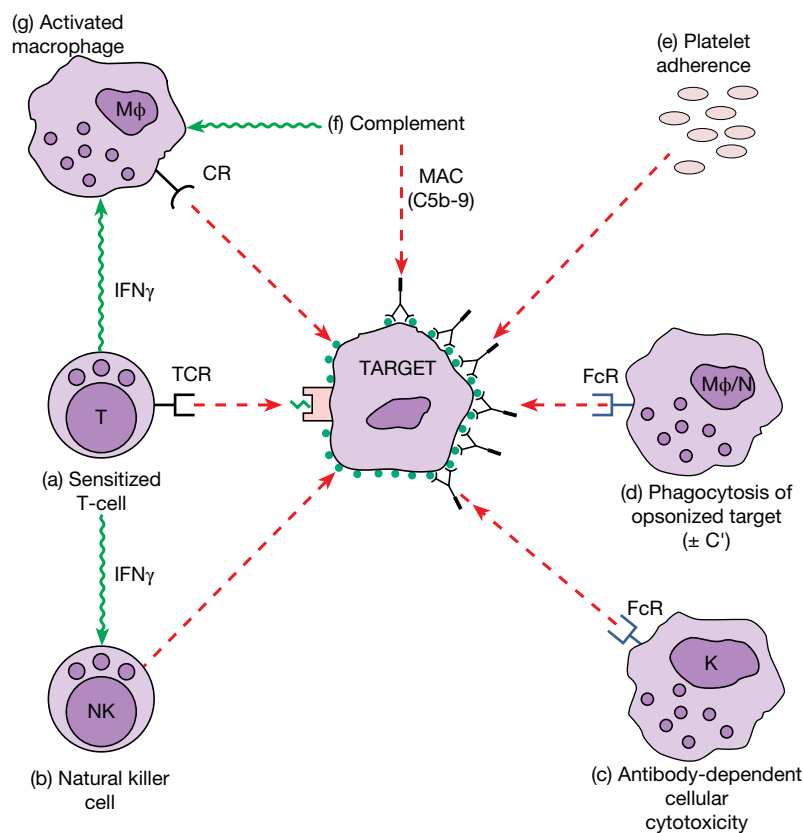


Figure 15.7 Mechanisms of target cell destruction. (a) Direct killing by Tc cells and indirect tissue damage through release of cytokines such as $\text{IFN}\gamma$ and TNF from Th1-cells. (b) Direct killing by NK cells enhanced by interferon. (c) Attack by antibody-dependent cellular cytotoxicity. (d) Phagocytosis of target coated with antibody (heightened by bound C3b). (e) Sticking of platelets to antibody bound to the surface of graft vascular endothelium leading to formation of microthrombi. (f) Complement-mediated cytotoxicity. (g) Macrophages activated nonspecifically by agents such as $\text{IFN}\gamma$ and possibly C3b can be cytotoxic for graft cells, perhaps through extracellular action of TNF and $\cdot\text{O}_2^-$ radicals generated at the cell surface. IFN, interferon; K, killer cell (any cell capable of mediating ADCC), M ϕ , macrophage; N, neutrophil, NK, natural killer cell.

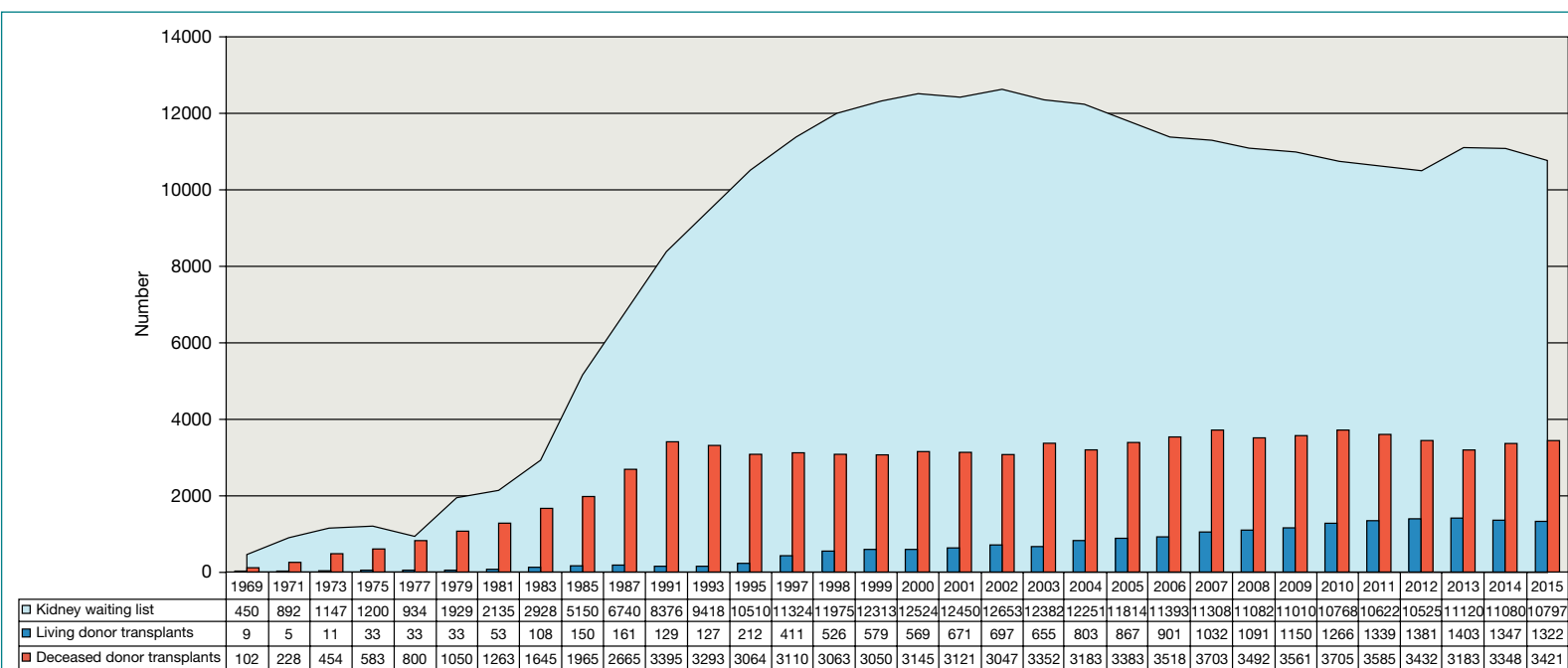


Figure 15.8 The unmet demand for kidney transplants. Dynamics of the Eurotransplant kidney transplant waiting list and transplants between 1969 and 2015. The curved line indicates the number of patients awaiting a kidney transplant, and underneath the far fewer number of transplants that have taken place is shown by the histogram, with deceased donor transplants indicated by the orange bars and living donor transplants by the black bars. (Source: *Eurotransplant Annual report 2015* (ed. Rahmel A). Eurotransplant International Foundation, Leiden.)

The polymorphism of the human HLA system

With so many alleles at each locus and several loci in each individual (Figure 15.9), it will readily be appreciated that this gives rise to an exceptional degree of polymorphism. This is of great potential value to the species, as the need for T-cells to recognize their own individual specificities provides a defense against microbial molecular mimicry in which a whole species might be put at risk by its inability to recognize as foreign an organism that generates MHC–peptide complexes similar to self. It is also possible that in some way the existence of a high degree of polymorphism helps to maintain the diversity of antigenic recognition within the lymphoid system of a given species and also ensures heterozygosity (hybrid vigor).

The value of matching tissue types

Improvements in surgical techniques and the use of immunosuppressive drugs have diminished the effects of mismatching HLA specificities on solid graft survival but, nevertheless, most transplanters favor a reasonable degree of matching (see Figure 15.18). Tissue typing can be carried out using serological methods that employ panels of antibodies each specific for a different HLA allele, and which enable the detection of the HLA variants on the cell surface of leukocytes. These techniques are increasingly being replaced by molecular genetics techniques, such as the use of sequence-specific oligonucleotide primers, to determine the variants. HLA-DR matching is the most critical in ensuring graft survival, followed by HLA-B and then HLA-A. In fact, it is often only these three

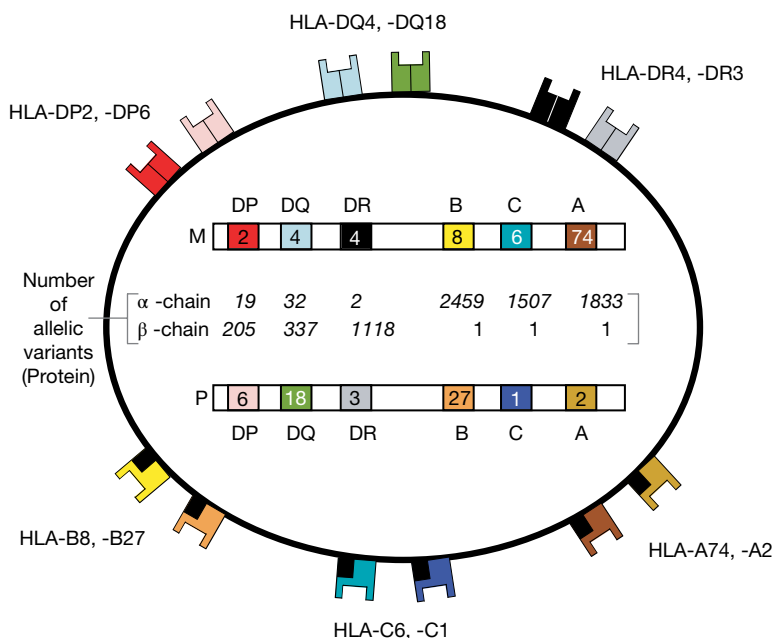


Figure 15.9 Polymorphic HLA specificities and their inheritance. As there are several possible alleles at each locus, the probability of a random pair of subjects from the general population having identical HLA specificities is very low. Indeed, the class I and II MHC genes are the most polymorphic in the genome and the number of different protein sequences encoded by the allelic variants assigned as of January 2014 are indicated by the numbers in italics in the center of the figure (data from <http://hla.alleles.org/nomenclature/stats.html>). The number of allelic variants at the nucleotide level is somewhat higher because of, for example, variations in intron sequences. In the example given the individual expresses the particular α - and β -chain alleles at the DP loci (see Figure 4.24) on the maternal (M) chromosome that specify HLA-DP2 (the actual nomenclatures are much more complex than this to enable designation of subtypes and intron nucleotide variations), and has inherited those for HLA-DP6 on the paternal (P) chromosome, and so on. These genes are co-dominantly expressed and therefore cells can express up to six different alleles of the main class I molecules and, on their professional APCs, additionally up to at least six different class II molecules. The fact that there are usually two DR β genes inherited on both copies of chromosome 6, and the potential for *trans* pairing as well as *cis* pairing of some class II α and β chains, further increases the HLA diversity in the individual. Conversely, homozygosity at any of the loci will reduce the number of variants. Note that not all polymorphisms in nucleotide sequence will result in a polymorphism at the protein level, and furthermore that not all polymorphisms in the polypeptide chain will affect binding of antigenic peptides or T-cell receptors to the MHC molecule and therefore impact upon transplant rejection. The MHC class I molecules all employ the same β chain, β_2 -microglobulin, that is nonpolymorphic, encoded outside of the MHC, and does not form part of the peptide-binding groove. There is a 1 : 4 chance that two siblings will be MHC identical because each group of specificities on a single chromosome forms a haplotype that will usually be inherited *en bloc*, giving four possible combinations of paternal and maternal chromosomes. Parent and offspring can only be identical (1 : 2 chance) if the mother and father have one haplotype in common.

loci that are typed. However, all mismatched MHC loci can contribute to sensitization, which becomes of particular importance if a repeat graft is required in the future. In addition to typing recipients and potential donors, cross-matching is carried out to ensure the absence of pre-existing antibodies to donor antigens in the proposed recipient. Hematopoietic stem cell grafts, including bone marrow grafts, require a very high degree of compatibility because of the increased potential for graft-versus-host disease in addition to host-versus-graft reactions; the greater accuracy of DNA typing methods and the inclusion of HLA-DQ typing can be most helpful in this respect.

Because of the many thousands of different HLA phenotypes possible (Figure 15.9), it is usual to work with a large pool of potential recipients on a continental basis (e.g., Eurotransplant, www.eurotransplant.org), so that when graft material becomes available the best possible match can be made. The position will be improved when the pool of available organs can be increased through the development of long-term tissue storage banks, but techniques are not good enough for this at present except in the case of hematopoietic stem cells that can be kept viable even after freezing and thawing. With a paired organ such as the kidney, living donors may be used; siblings provide the best chance of a good match. However, the use of living donors poses difficult ethical problems and organs are most commonly obtained from brain-dead donors in which there has been a loss of all brain function, including that of the brain stem that controls respiration.

There is active interest in the possibility of using animal organs or mechanical substitutes, while some are even trying to prevent the disease in the first place!

Immunosuppression

Most transplants are allografts and it is virtually impossible to completely match the donor and recipient. Therefore powerful and potentially toxic immunosuppressive drugs (Figure 15.10) need to be given in order to limit immunological rejection. The development of an immunological response requires the active proliferation of a relatively small number of antigen-sensitive lymphocytes to give a population of sensitized cells large enough to be effective. Many of the immunosuppressive drugs that have been used in transplant recipients were first developed for cancer chemotherapy because of their toxicity to dividing cells. Aside from the complications of blanket immunosuppression, these anti-mitotic drugs are especially toxic for cells of the bone marrow and small intestine and must therefore be used with great care. Thus, because the drugs used are not specific just for anti-donor lymphocytes, patients on immunosuppressive therapy tend to be susceptible to opportunistic infections with a variety of viral, bacterial, fungal, and parasitic diseases. They are also more prone to develop virus-induced cancers such as lymphomas, cervical cancer, and Kaposi sarcoma.

Immunosuppression is employed as follows:

- **Induction therapy:** The aim here is to deliver intensive immunosuppression at the time of transplantation to ensure that the immune system is stopped in its tracks when being provoked by the arrival of the foreign graft. Anti-T-cell antibodies (for example rabbit anti-thymocyte globulin) and/or IL-2 receptor antagonists (such as basiliximab which binds to CD25, the IL-2 receptor α chain) are typically employed.

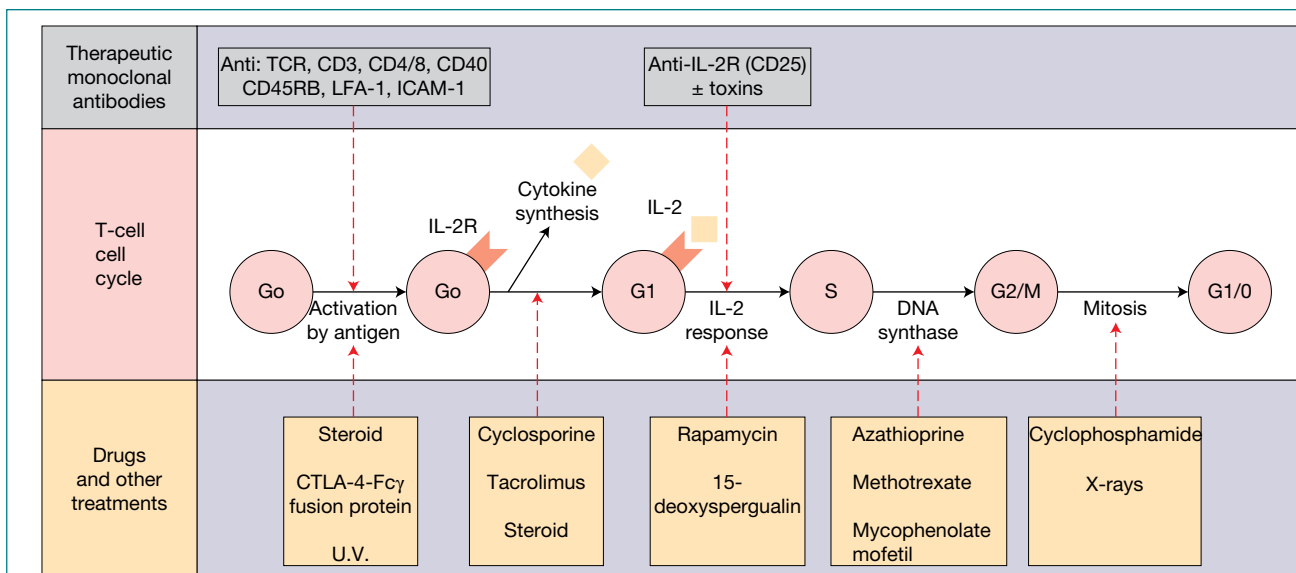


Figure 15.10 Immunosuppressive agents that block the cell cycle of T-cells. A variety of antibodies and inhibitory drugs can be used in transplantation and/or other clinical settings to block the proliferation of T-cells. Simultaneous treatment with agents acting at sequential stages in development of the rejection response would be expected to lead to strong synergy and this is clearly seen with cyclosporine and rapamycin.

- **Maintenance therapy:** If immunosuppression is removed the donor organ or tissue will be immunologically rejected. Therefore transplant recipients usually need to be maintained on immunosuppressive drugs for the rest of their lives. A balance needs to be achieved between adequate dampening of the immune response to prevent graft rejection while limiting drug toxicity and also maintaining sufficient immune responsiveness for the patient to combat infection. Typically, calcineurin inhibitors (tacrolimus or cyclosporine), purine metabolism inhibitors (azathioprine or mycophenolate mofetil), and mTOR inhibitors (rapamycins) are used, often together with steroids.
- **Treatment of rejection episodes:** Humoral rejection can be treated with intravenous immunoglobulin, plasmapheresis, and the anti-CD20 antibody rituximab. A variety of immunosuppressive anti-T-cell agents are also commonly employed.

Anti-T agents such as anti-CD3 antibodies are in widespread use. The IL-2 receptor α chain (CD25), expressed by activated but not resting T-cells, represents another exploitable target. Basiliximab is a chimeric (mouse V region, human C region) anti-CD25 antibody of particular benefit in the prevention of acute kidney transplant rejection when used in combination with cyclosporine plus corticosteroids.

Another effective anti-T-cell biologic is belatacept, a fusion protein of the extracellular domain of CTLA-4 with human IgG1 Fc in which two amino acid replacements in CTLA-4 provide an increased ability to block the activity of the CD80/CD86 co-stimulatory molecules required for T-cell activation. In phase III clinical trials this drug was shown to be as effective as cyclosporine but with less damaging effects on the kidney.

A commonly used drug in this field is **azathioprine**, which inhibits nucleic acid synthesis and has a preferential effect on T-cell-mediated reactions. A group of fungal metabolites dramatically improved graft survival in human transplantation and are also of benefit in the therapy of immunological disorders through their ability to target T-cells. **Cyclosporine** is a neutral hydrophobic 11-amino-acid cyclical peptide generated by the fungus *Beauveria nivea*. It functions as a **calcineurin inhibitor** and selectively blocks the transcription of IL-2 in activated T-cells. Resting cells that carry the vital memory for immunity to microbial infections are spared and there is little toxicity for dividing cells in gut and bone marrow, although when used at high doses nephrotoxicity is a substantial issue. The drug also directly affects dendritic cells, inhibiting a number of their functions including antigen processing, production of TNF and IL-12, expression of chemokine receptors, and cell migration. Cyclosporine is firmly established as a first-line therapy in the prophylaxis and treatment of transplant rejection. Another T-cell-specific immunosuppressive drug, **tacrolimus**, contains a macrolide ring structure and although originally also found in a fungus, is isolated from the bacterium *Streptomyces tsukubaensis*. Like cyclosporine, tacrolimus is a calcineurin inhibitor that blocks various T-cell and dendritic cell activities but (again like cyclosporine) it has the drawback that it is nephrotoxic at high doses.

The **rapamycins** (**sirolimus** and **everolimus**) are also macrolides, but in contrast to tacrolimus they block mTOR signals induced by combination of IL-2 with its receptor. Sirolimus is a product of *Streptomyces hygroscopicus* whereas everolimus is a 2-hydroxyethyl substituted derivative of sirolimus. Yet another group of immunosuppressives are the pro-drugs **mycophenolate mofetil** and **mycophenolate sodium**, which when metabolized to mycophenolic acid inhibit the inosine monophosphate dehydrogenase enzyme required for lymphocyte proliferation.

Regarding the molecular details of the mode of action of these drugs, cyclosporine complexes with cyclophilin A, a member of the **immunophilin** family, whereas tacrolimus complexes with another immunophilin family member, FK-binding protein (FKBP) (Figure 15.11). These complexes then interact with and inhibit the calcium- and calmodulin-dependent phosphatase calcineurin, which activates the NFAT (nuclear factor of activated T-cells) transcription factor for IL-2 in activated T-cells. Although rapamycins also bind to FKBP, the complex has a quite different activity and inhibits the mTOR (target of rapamycin) serine/threonine kinase. The immunosuppressive activity of the rapamycins is at least partially explained by the fact that mTOR plays a central role in transducing proliferative signals, such as those through the IL-2 receptor. In addition to its role in transplantation, cyclosporine is used in a wide range of disorders where T-cell-mediated hypersensitivity reactions are suspected. Indeed, the benefits of cyclosporine in diseases such as rheumatoid arthritis, psoriasis, idiopathic nephrotic syndrome, type 1 diabetes, Behçet's syndrome, active Crohn's disease, aplastic anemia, and severe corticosteroid-dependent asthma have been interpreted to suggest or confirm a pathogenic role for the immune system. Inhibition of keratinocyte proliferation by cyclosporine may contribute to the favorable outcome seen in patients with psoriasis who are treated with this drug. A rapid onset of benefit, and of relapse when treatment is stopped, are common features of cyclosporine therapy. Owing to cyclosporine's nephrotoxicity it has to be used at doses below those causing the renal fibrosis which results from its stimulation of TGF β production by several cell types.

Because cyclosporine and rapamycin act at different stages in the activation of the T-cell (Figure 15.10) they show an impressive degree of synergy that allows the two drugs to be used together at considerably lower dose levels with correspondingly less likelihood of side-effects. Steroids such as prednisolone intervene at many points in the immune response, affecting lymphocyte recirculation and the generation of cytotoxic effector cells, for example; in addition, their outstanding anti-inflammatory potency rests on features such as inhibition of neutrophil adherence to vascular endothelium in an inflammatory area and suppression of monocyte/macrophage functions such as microbicidal activity and response to cytokines. Corticosteroids form complexes with intracellular receptors that then bind to regulatory genes and block transcription of TNF, IFN γ , IL-1 β , IL-2,

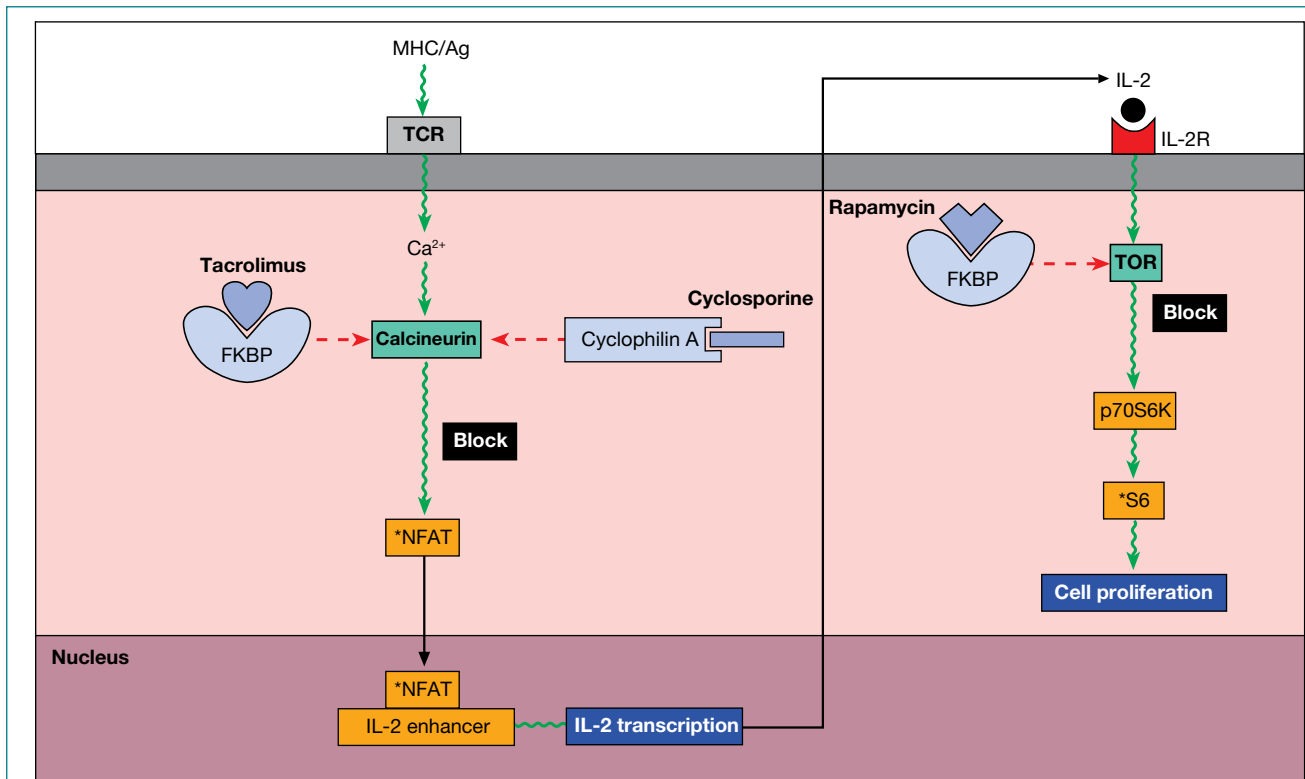


Figure 15.11 The mode of action of cyclosporine, tacrolimus, and rapamycin. The complexes of cyclosporine with cyclophilin A and of tacrolimus with FKBP (FK506 [tacrolimus]-binding protein) bind to and inactivate the phosphatase calcineurin responsible for activating the nuclear factor of activated T-cells (NFAT) transcription factor for IL-2 synthesis. The rapamycin–FKBP complex inhibits the TOR (target of rapamycin) kinase and thereby blocks the activation of p70 S6 kinase by transduced IL-2 signals, thus inhibiting cell proliferation.

IL-3, IL-6, and MHC class II (i.e., they block expression of cytokines from both lymphocytes and macrophages, whereas cyclosporine has its main action on the former).

Inducing tolerance to graft antigens

If the disadvantages of blanket immunosuppression are to be avoided, we must aim at knocking out only the reactivity of the host to the antigens of the graft, leaving the remainder of the immunological apparatus intact – in other words, the induction of *antigen-specific tolerance*.

It turns out that hematopoietic cells represent an excellent source of tolerogenic alloantigens, and the production of stable mixed chimerism by such cells engrafted from bone marrow is proving to be a potent means of inducing robust specific transplantation tolerance to solid organs across major MHC mismatches. However, successful allogeneic bone marrow transplantation in immunocompetent adults normally requires cytoreductive treatment of recipients with irradiation or cytotoxic drugs and this has tended to restrict its use to malignant conditions. A most encouraging study in mice showed the feasibility of inducing long-lasting tolerance not only to bone marrow cells but also to fully MHC-mismatched skin grafts in naive recipients receiving high-dose bone marrow transplantation and *co-stimulatory blockade* by single injections of

monoclonal anti-CD154 (CD40L) plus a CTLA-4–Ig fusion protein (Figure 15.12). A persistent hematopoietic macrochimerism is achieved with a significant proportion of donor-type lymphocytes in the thymus, indicating intrathymic deletion of donor-reactive T-cells.

Although this protocol permits long-term engraftment of bone marrow and solid organs, it seems that direct blockade with just anti-CD154 and CTLA-4–Ig is sufficient to induce tolerance to solid organ grafts. Stimulation of alloreactive T-cells by the graft in the presence of co-stimulatory blockade leads to apoptosis, a process promoted by rapamycin that improves the tolerant state. Bcl- x_L (see Figure 9.8) prevents both T-cell apoptosis and tolerance induction by this treatment, revealing the importance of apoptotic T-cell deletion for the establishment of antigen-specific unresponsiveness. In a further twist to the tale, the apoptotic T-cells “reach from beyond the grave” by producing IL-10, so that their phagocytosis along with antigen leads to the presentation of the antigen in a tolerogenic form that maintains tolerance through the production of immunoregulatory cells.

Despite the role of the *mature* dendritic cell as the champion stimulator of resting T-cells, the “*immature*” dendritic cells may present antigen in the absence of B7 co-stimulators and, by mechanisms echoing those described above in the co-stimulatory

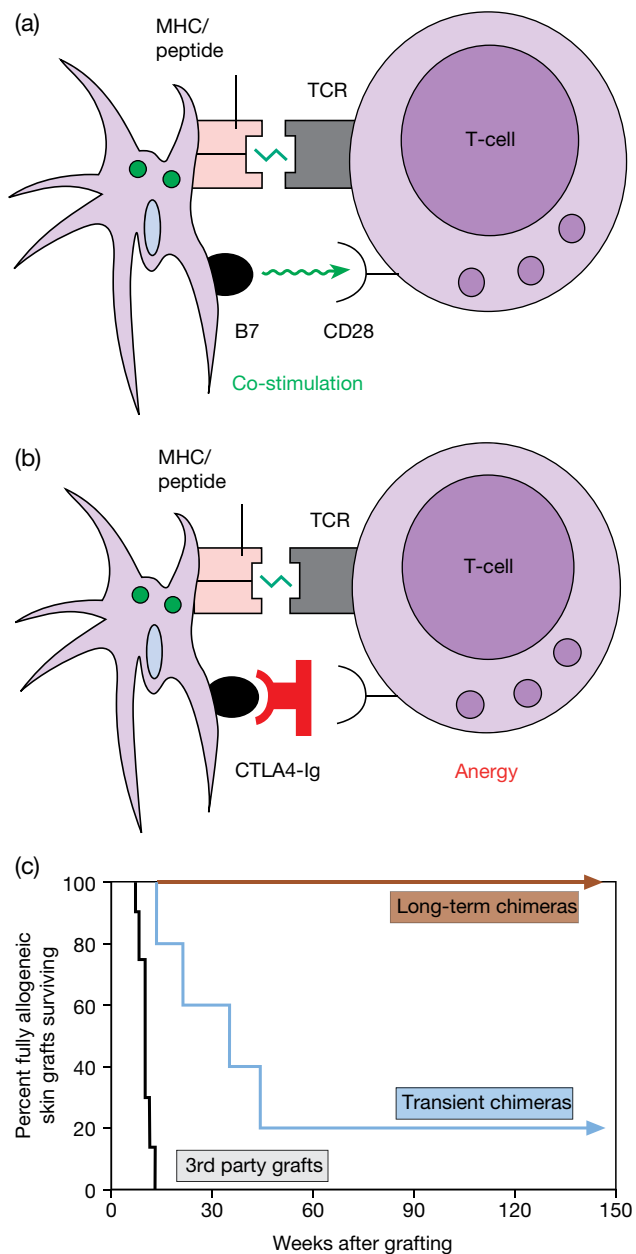


Figure 15.12 Co-stimulatory blockade. (a) T-cell activation requires co-stimulatory signals, in particular engagement of CD28 on the T-cell surface by the B7 molecules (CD80 and CD86) on the surface of the APC. (b) CTLA-4 binds to CD80/86 with higher affinity than CD28 and therefore the soluble CTLA-4-Ig fusion protein is able to block these co-stimulatory signals, resulting in T-cell anergy. Similarly, a monoclonal antibody to CD40L on the T-cell would block co-stimulatory signals normally provided by CD40 on the APC. (c) Induction of tolerance and macrochimerism by fully allogeneic bone marrow transplantation plus co-stimulatory blockade. B6 mice received bone marrow cells from the fully allogeneic B10.A strain with injections of anti-CD154 (CD40L) and the CTLA-4-Ig fusion protein that blocks CD80/CD86-CD28 interactions. Eight mice showing long-term persistence of multilineage donor cells (macrochimerism) were fully tolerant to B10.A skin grafts. Five mice with transient chimerism showed moderate prolongation of skin graft survival relative to unrelated third-party grafts. (Data source: Wekerle T. et al. (2000) *Nature Medicine* 6, 464.)

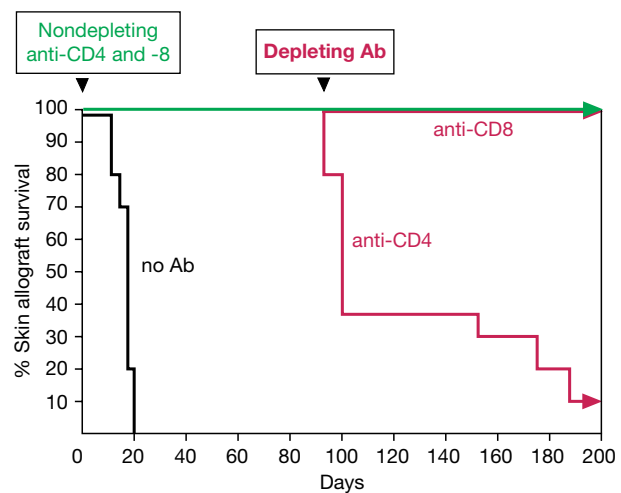


Figure 15.13 Induction of allograft tolerance by nondepleting anti-CD4 plus anti-CD8. Tolerance to skin grafts from donors with multiple minor transplantation antigen mismatches was achieved by concurrent injection of IgG2a monoclonal antibodies to CD4 and CD8 that do not induce cell depletion (green arrow). The maintenance of tolerance depends upon the continued presence of antigen, which enables the unresponsive cells to interact with newly arising immunocompetent cells on the surface of the same antigen-presenting cells and render them unresponsive through an infectious tolerance mechanism. Loss of tolerance on depletion of CD4 but not CD8 cells (red arrows) shows that active tolerance is maintained by the CD4 subset. Indeed, tolerance can be transferred by CD4⁺CD25⁺ T-regulatory cells. (Data source: S.P. Cobbold and H. Waldmann.)

blockade experiments, would appear to have a powerful potential for tolerance induction. This concept is of particular relevance to the specific unresponsiveness generated by grafts of liver that, being a hematopoietic organ, continually exports large numbers of these immature dendritic cells.

Nondepleting anti-CD4 and anti-CD8 monoclonals, by depriving T-cells of fully activating signals, can render them anergic when they engage antigen through their specific receptors. These anergic cells can induce unresponsiveness in newly recruited T-cells (“infectious tolerance”) and so establish specific and indefinite acceptance of mouse skin grafts across class I or multiple minor transplantation antigen barriers (Figure 15.13). It should be noted that skin allografts provide the most difficult challenge for tolerance induction, and transplants of organs such as the heart, which are less fastidious than skin, require less aggressive immunotherapy.

Given the wide variety of different peptide epitopes presented by the graft MHC, full-frontal attack on the alloreactive T-cells by administration of tolerogenic peptides represents quite a challenge, and the strategy of using co-stimulatory blockade with the antigens being provided by the graft itself looks to be a more promising route.

Is xenografting a practical proposition?

Because the supply of donor human organs for transplantation lags seriously behind the demand, a widespread interest in the feasibility of using animal organs is emerging. Pigs are more favored than primates as donors both on the grounds of ethical acceptability and the hazards of zoonoses – nonhuman primates harbor many retroviruses and herpesviruses that have the potential to cause significant disease in humans. Pig heart valves have been successfully used for decades on millions of patients in valve replacement procedures. However, in this case the valves have greatly reduced immunogenicity because of prior treatment with glutaraldehyde. This fixation procedure cannot be used where an entire functioning heart or other organ is to be transplanted. The first hurdle to be overcome in these cases is therefore the **hyperacute rejection** that occurs as a result of xenoreactive natural antibodies in the host. The sugar structure galactose α -1,3-galactose (Gal α -1,3-Gal) is absent in humans, apes and Old World monkeys owing to a mutation in the gene encoding α -1,3-galactosyltransferase in these species. They are therefore not immunologically tolerant to this nonself sugar structure. Furthermore, they have pre-existing antibodies to the Gal α -1,3-Gal epitope, which is present on many common bacteria and expressed abundantly on the xenogeneic pig vascular endothelium. The natural antibodies bind to the endothelium and activate complement in the absence of regulators of the human complement system, such as decay accelerating factor, CD59, and MCP (see Figure 13.6), precipitating the hyperacute rejection phenomenon. Novel genetic engineering strategies for the solution of this

problem are outlined in Figure 15.14. Genetically modified pigs are also being explored as a potential source of islet cells for transplantation in patients with type 1 diabetes.

The next crisis is **acute vascular rejection** occurring within 6 days as *de novo* antibody production is elicited in response to the xenoantigens on donor epithelium. IL-12 and IFN γ inhibit acute vascular rejection of xenografts and, over the long term, IFN γ may protect the graft by promoting the formation of NO $_2$, which prevents constriction of blood vessels. A limited degree of success has been achieved using baboons as recipients of hearts or kidneys from α -1,3-galactosyltransferase knockout pigs, although fairly hefty immunosuppressive regimens were employed together with, in the case of the kidney grafts, co-transplantation of thymic tissue with the aim of inducing tolerance in the recipient.

Even when the immunological problems are overcome, it remains to be seen whether the xenograft will be compatible with human life over a prolonged period. There is also concern over the presence of porcine endogenous retroviruses (PERVs), which are related to viruses associated with leukemias in a number of species. Given that the PERV-A receptors PAR-1 and PAR-2 are widely distributed in human tissues, such concerns are warranted, although it is unclear if infection of human cells with such viruses would have detrimental consequences.

Stem cell therapy

The ideal transplant is one created **entirely from cells of the recipient** (i.e., an autograft), which would eliminate the need for immunosuppression. It is possible to isolate stem cells from

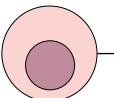
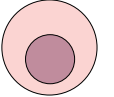
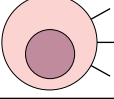
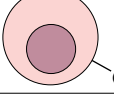
Genetic manipulation of pig	Graft	+Human natural anti-Gal + C'	Hyperacute rejection
-	 Gal α -1,3-Gal	→	+++
Knockout α -1,3-galactosyltransferase		→	-
Or make transgenic for human DAF or CD59	 DAF Gal α -1,3-Gal CD59	→	-
Or transfect cells with α -1,2-fucosyl transferase	 Gal α -1,3-Gal-1,2-Fuc	→	-

Figure 15.14 Strategies for avoiding complement-mediated hyperacute rejection of a xenograft caused by reaction of natural antigalactose antibodies with Gal α -1,3-Gal on the surface of the pig graft cells. Heart or kidney xenografts from α -1,3-galactosyltransferase knockout pigs can function for reasonable periods of time in baboons, as can hearts from transgenic pigs expressing the human complement regulatory proteins decay accelerating factor (DAF) or CD59. Transfection of pig cells with α -1,2-fucosyltransferase leads to the “covering up” of the Gal α -1,3-Gal structure with a terminal fucose, thus preventing the binding of the antigalactose. Other strategies involve transfection with genes encoding an α -galactosidase or intracellular recombinant scFv reacting with α -1,3-galactosyltransferase.

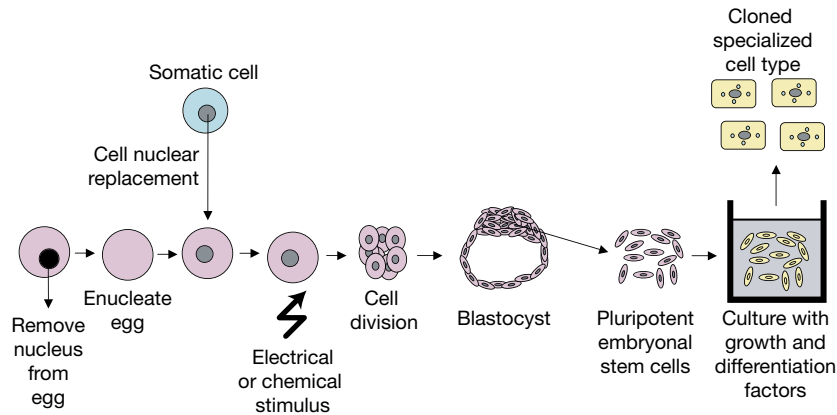


Figure 15.15 Cell nuclear replacement for therapeutic cloning. The nucleus of an egg is replaced with the nucleus from a body cell, such as a mammary gland cell or skin cell. The egg is then stimulated electrically or with chemicals to initiate cell division. Following its development into an embryo the stem cells can be isolated and are then driven to develop into the desired cell type by culture with appropriate growth and differentiation factors.

various adult organs including bone marrow. By way of an example, human bone marrow-derived multipotent stem cells have been shown to induce therapeutic neovascularization and cardiomyogenesis in a rat model of myocardial infarction. The development of cell nuclear replacement techniques have also opened up the possibility of therapeutic cloning using embryonic stem cells (Figure 15.15). Knowledge is steadily accumulating concerning the various growth factors required to guide relatively undifferentiated stem cells into the desired mature form, for example pancreatic, nerve, or liver cells for regenerative therapy, or erythrocytes for transfusion.

An exciting development came a few years back from the cloning of “Dolly” the sheep, the first cloned animal produced from a cell taken from an adult animal. Such reproductive cloning has led to concerns that cloned human embryos could be re-implanted and used in attempts to produce cloned humans. However, in therapeutic cloning the embryo is only allowed to grow for a few days in order to provide a source of stem cells for subsequent differentiation and expansion *in vitro*. A major step in this direction was the announcement in 2005 that a team at the University of Newcastle in the United Kingdom had succeeded in their attempts to clone a human blastocyst. More recently several groups have been able to genetically reprogram adult tissue cells by introducing genes encoding a number of transcription factors in order to generate what are referred to as induced pluripotent stem cells. These powerful technologies have the potential to eventually revolutionize the treatment of paralysis and neurodegenerative conditions such as Parkinson’s and Alzheimer’s diseases using transfer of stem cell-derived neuronal cells. Stem cell therapy is also being actively explored for the treatment of heart disease, diabetes, visual impairment, and many other afflictions. The potential to grow stem cells on a matrix in order to engineer tissues or even whole organs provides further opportunities to circumvent the problem of allograft rejection (Figure 15.16).

The first successful transplant of an engineered tissue was reported in 2008, in which a trachea grown from the recipient’s own stem cells was given to a patient with collapsed airways following a severe *M. tuberculosis* infection.

Clinical experience in grafting

Privileged sites

Corneal grafts survive without the need for immunosuppression. Because they are avascular they tend not to sensitize the recipient. This privileged protection is boosted by the local production of immunosuppressive factors such as TGF β , IL-1Ra, limited expression of MHC, and the strategic presence of FasL, which can induce apoptosis in infiltrating lymphocytes. Nonetheless, they do become cloudy if the individual has been **presensitized**. Grafts of **cartilage** are successful in the same way but an additional factor is the protection afforded the chondrocytes by the matrix. With bone and artery it does not really matter if the grafts die because they can still provide a framework for host cells to colonize.

Kidney grafts

Hundreds of thousands of kidneys have been transplanted worldwide and with improvement in patient management there is a good survival rate (Figure 15.17). In the long term (1 year or more), the desirability of matching at the HLA-A, -B, and -DR loci becomes apparent, although the effect is not overwhelming (Figure 15.18).

Patients are already partially immunosuppressed at the time of transplantation because uremia causes a degree of immunological nonresponsiveness. The **combination** of two or three immunosuppressive agents, for example a calcineurin inhibitor such as cyclosporine, azathioprine (now often replaced with mycophenolate mofetil), and a

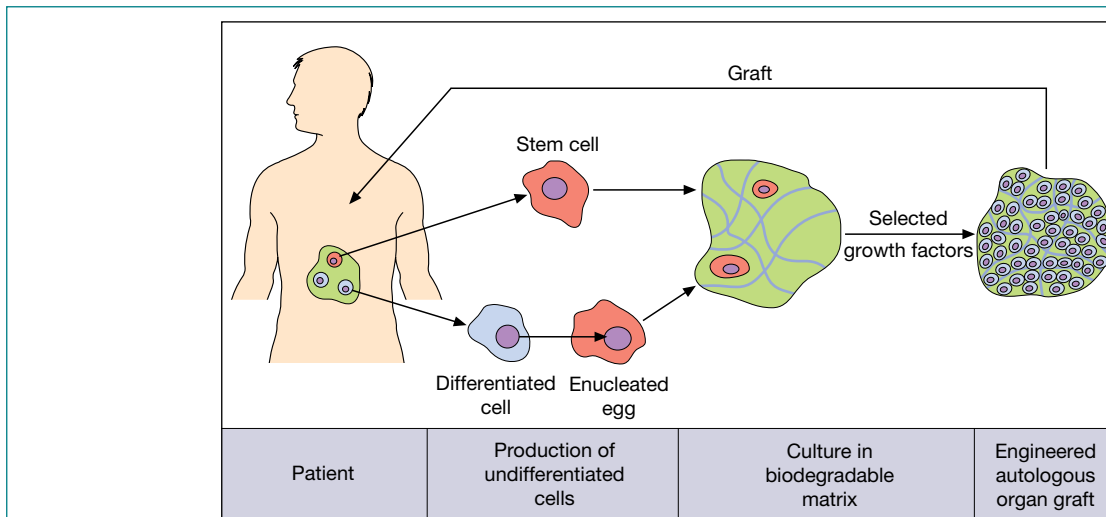


Figure 15.16 Production of autologous grafts by tissue engineering. Undifferentiated cells are obtained directly from the patient either as adult stem cells or by cell nuclear replacement into enucleated oocytes. They are cultured in a biodegradable matrix with appropriate growth factors to provide a tissue populated with differentiated cells that can function as an autologous graft.

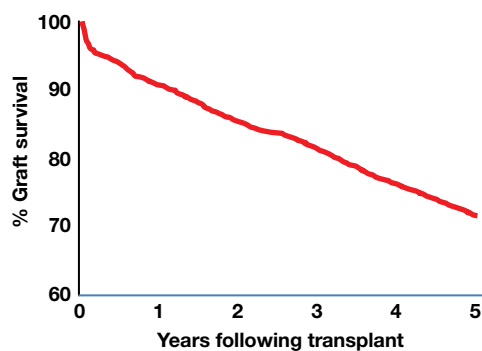


Figure 15.17 Survival of primary cadaveric kidney grafts. Data for transplants undertaken from 1994–2003. (Data source: OPTN (optn.transplant.hrsa.gov) 2011.)

glucocorticosteroid such as prednisolone has been the mainstay for long-term management of kidney grafts (Figure 15.10). The synergy between cyclosporine and rapamycin is also exploited to beneficial effect. These drugs are initially given at a relatively high dose, the induction phase, for the first few months following transplantation when the anti-donor immune response is at its most vigorous, and then at reduced concentrations for the subsequent maintenance phase that is usually required throughout life. If kidney function is poor during a rejection crisis, renal dialysis can be used. When transplantation is performed because of immune complex-induced glomerulonephritis, the immunosuppressive treatment used may help to prevent a similar lesion developing in the grafted kidney. Patients with glomerular basement membrane antibodies (e.g., Goodpasture's syndrome) are likely to destroy their renal transplants unless first treated with plasmapheresis and immunosuppressive drugs.

Heart transplants

The overall 1-year organ survival figure for heart transplants has moved up to over 85% (Figure 15.19), helped considerably by the introduction of combination immunosuppressive therapy of the type mentioned above. Aside from the rejection problem, it is likely that the number of patients who would benefit from cardiac replacement is much greater than the number dying with adequately healthy hearts. Given this relative lack of donors more attention is being given to the possibility of gene therapy, tissue engineered hearts, xenogeneic grafts, and mechanical substitutes.

Liver transplants

Survival rates for orthotopic (in the normal or usual position) liver grafts are just slightly lower than those achieved with heart transplants (Figure 15.19). The hepatotropic capacity of tacrolimus is an added bonus that makes it the preferred drug for liver transplantation. Rejection crises are dealt with by high-dose steroids and, if this proves ineffective, anti-lymphocyte globulin. The use of a synthetic colloidal hydroxyethyl starch solution containing lactobionate allows livers to be preserved for 24 hours or more and has revolutionized the logistics of liver transplantation. To improve the prognosis of patients with primary hepatic or bile duct malignancies, which were considered to be inoperable, transplantation of organ clusters with liver as the central organ has been used (e.g., liver and pancreas, or liver, pancreas, stomach, and small bowel or even colon). Nonetheless, the outcome is not very favorable in that up to three-quarters of the patients transplanted for hepatic cancer have recurrence of their tumor within 1 year. For the future we must look forward to the creation of autologous liver from adult cells when tissue engineering techniques have been developed sufficiently.

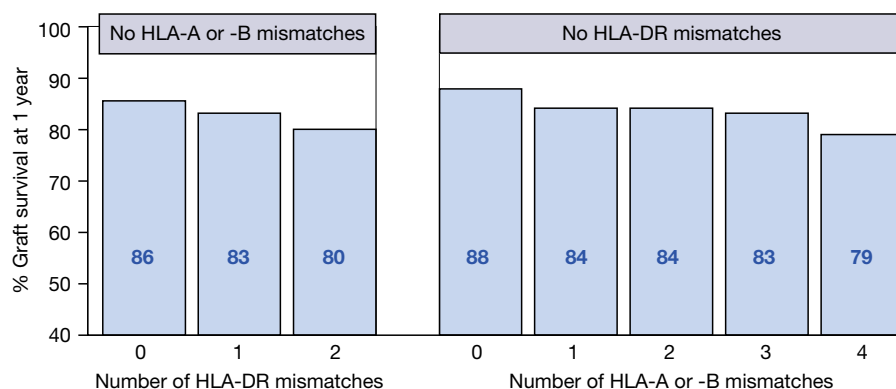


Figure 15.18 Contribution of MHC matching to kidney graft survival. First cadaveric kidney graft survival at 1 year for the period January 1993 to December 1997 ($n=12584$) on the basis of mismatches for HLA-A, -B, and -DR. There is a significant influence of matching, $p < 0.001$, for both sets of data. (Data source: Guido Persijn and Jacqueline Smits of the Eurotransplant.)

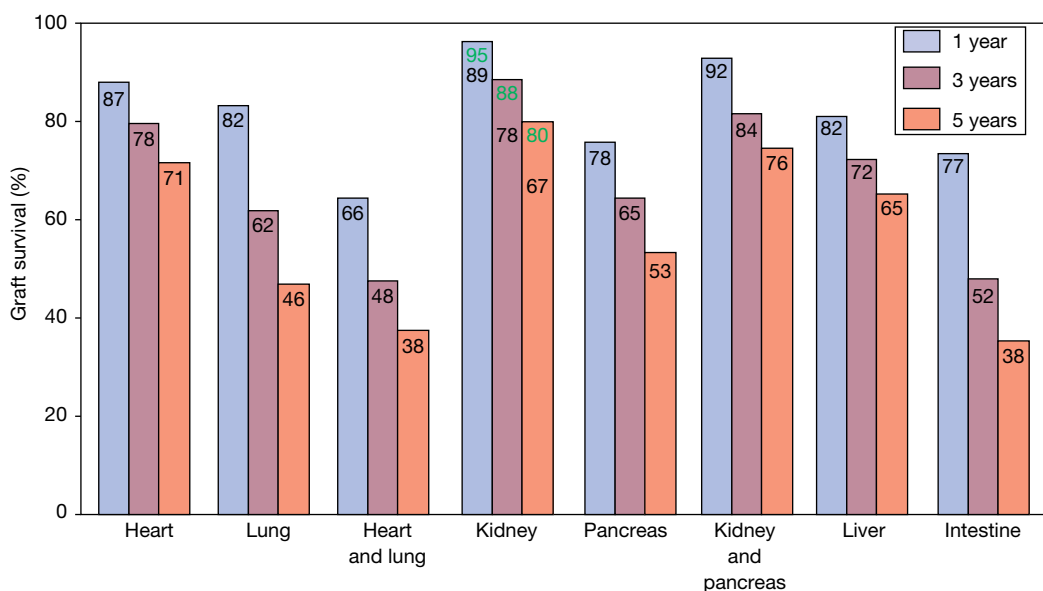


Figure 15.19 Comparison of graft survival rates for different organs. For kidney the higher figure is for transplants from living donors, the lower value the more common situation of organs from deceased donors. Liver transplants survive for a similar time whether or not they are from living or deceased donors. Survival rates for repeat transplants of all organs are generally somewhat lower. (Data source: OPTN (optn.transplant.hrsa.gov) 2008.)

Experience with liver grafting between pigs revealed an unexpected finding. Many of the animals retained the grafted organs in a healthy state for many months without any form of immunosuppression and enjoyed a state of unresponsiveness to grafts of skin or kidney from the same donor. True tolerance is induced by the donor-type intrahepatic hematopoietic stem cells and immature dendritic cells (see earlier) and possibly also by the liver parenchyma itself, known to produce copious amounts of soluble MHC class I.

Work is in progress on the transfer of isolated hepatocytes attached to collagen-coated microcarriers injected intraperitoneally for the correction of isolated deficiencies such as albumin

synthesis. This attractive approach has much wider application as a general vehicle for gene therapy.

Hematopoietic stem cell grafts

Patients with certain immunodeficiency disorders and aplastic anemia are obvious candidates for treatment with *multipotent hematopoietic stem cells (HSCs)* isolated from bone marrow, peripheral blood, or cord blood; so, too, are patients with leukemia, lymphoma, myeloma, and metastatic breast cancer treated radically with intensive chemotherapy and possibly whole-body irradiation in attempts to eradicate the neoplastic cells, as will be discussed in Chapter 16.

Bone marrow contains not only HSCs but also mesenchymal stem cells that can give rise to cartilage, tendons, and bone; after expansion in culture by a factor of 5–10 times, they provide an excellent treatment for children with osteogenesis imperfecta, a genetic disorder in which the osteoblasts produce defective type I collagen with resulting osteopenia (moderately reduced bone density) and severe bony deformities. Favorable results have been obtained with stem cell transplantation *in utero* for severe combined immunodeficiency (SCID) using populations from paternal bone marrow enriched for the stem cell marker CD34. From the practical standpoint, it has been recognized that cord blood contains sufficient HSCs for bone marrow replacement, but what is even more convenient is to use cytokines such as granulocyte colony-stimulating factor (G-CSF) to mobilize donor stem cells out of the bone marrow to increase the number of peripheral blood stem cells (PBSCs). Transplantation with either autologous (involving re-infusion of CD34⁺ cells taken prior to myeloablative therapy) or allogeneic PBSCs results in a more rapid recovery in neutrophil and platelet numbers than that seen following bone marrow transplantation, and in many centers is rapidly replacing bone marrow as the source of such cells. Allogeneic cells can exhibit a graft-versus-tumor effect, although this needs to be weighed against the risk of graft-versus-host (GVH) disease. HSC transplantation is also increasingly being explored as a mechanism of inducing tolerance to donor antigens in solid organ transplantation by creating a state of chimerism in the recipient, which would then lead to deletion or inactivation of the relevant alloreactive lymphocytes.

Graft-versus-host disease results from allogeneic T-cells in the graft

GVH disease resulting from a GVH reaction (i.e., the recognition of recipient antigens by allogeneic T-cells in the bone marrow or peripheral blood-derived inoculums) represents a serious, sometimes fatal, complication. The incidence of GVH disease is reduced if T-cells are first depleted with a cytotoxic cocktail of anti-T-cell monoclonals.

It is fondly hoped that successful engraftment and avoidance of GVH reactions following allogeneic cell transplantation will be achieved in the clinic by strategies such as co-stimulatory blockade (see Figure 15.12) without a requirement for cytoablative treatment of graft or recipient. Until then, successful results are more likely with highly compatible donors, particularly if fatal GVH reactions are to be avoided, and here siblings offer the best chance of finding a matched donor. Undoubtedly, non-HLA minor transplantation antigens are important and are more difficult to match. Acute GVH disease occurring within the first 100 days following infusion of allogeneic cells primarily affects the skin, liver, and gastrointestinal tract. Current therapy uses steroids such as prednisolone in combination with either cyclosporine or tacrolimus, but inclusion of methotrexate in this regimen is said to improve efficacy. Chronic GVH disease (i.e., later than 100 days) has a relatively

good prognosis if limited to skin and liver, but if multiple organs are involved, clinically resembling progressive systemic sclerosis, the outcome is poor. Patients are treated with cyclosporine and prednisolone. The pathogenesis of GVH disease may initially involve secretion of IL-1 β , TNF, and IFN γ from damaged host tissue, with both donor and recipient dendritic cells activating donor Th1 cells to secrete IL-2 and more IFN γ . The host is attacked by donor cytotoxic T-cells and NK cells using both the Fas–FasL and the perforin/granzyme B pathways to induce apoptotic cell death, with production of TNF also putting the boot in. There is hope that Treg cells can be harnessed to limit this process, and experiments in animal models are in progress to evaluate the efficacy of such approaches. In one such model, mice treated with anti-IL-21 monoclonal antibody had reduced GVH disease mortality that was associated with an increase in Foxp3⁺-inducible Treg cells in the lamina propria of the colon. Thus blockade of IL-21 *in vivo* led to the induction of Tregs in preference to IL-21-induced Th1 and Th17 cell differentiation.

Other organs and tissues

It is to be expected that improvement in techniques of control of the rejection process will encourage transplantation in several other areas, for example in type 1 diabetes where the number of transplants recorded is rising rapidly. The current 5-year organ-survival rate is around 75% for simultaneous transplantation of **pancreas and kidney** (Figure 15.19). Transplantation with isolated **islet cells** is a more attractive option that avoids the need for major surgery and appears to require less immunosuppression than that required following transplantation of a pancreas. Collagenase is injected into the pancreatic duct in a brain dead donor and the recovered islets purified by density gradient centrifugation. These are then infused into the hepatic portal vein of the recipient, from where they lodge in the liver sinusoids. Recently, the procedure has been successfully extended to using islets isolated from a fragment of pancreas removed from a living donor. The benefits of islet cell transplantation as an alternative to insulin injections do, of course, need to be weighed against the risks of the immunosuppression that is required.

The 5-year graft survival rate for **lung** and simultaneous **heart–lung** is improving but is still less than satisfactory (Figure 15.19). Transplantation of intestine is also in need of improvement, with 5-year graft survival at 38% in the United States (Figure 15.19). One also looks forward to the day when the successful transplantation of **skin** for lethal burns becomes more commonplace.

The grafting of **neural tissues** has the potential to benefit patients with neurodegenerative conditions such as Parkinson's disease, Huntington's disease, and stroke. Indeed, the transplantation of human fetal mesencephalic tissue into the brain of patients with Parkinson's disease has shown that dopaminergic neurons from such tissue can integrate into the brain's neuronal circuits. Some patients were able to discontinue treatment with l-dopa for a period of several years. However,

such transplantation is far from routine and the results from clinical trials have been very mixed. As already mentioned, researchers are turning to stem cells as a source of neurons. Induced pluripotent stem cells can be generated from adult patients, avoiding the need for tissue matching and circumventing ethical objections to the use of embryonic stem cells. However much remains to be learnt regarding the mechanisms involved in the cell fate decisions that determine whether these cells develop into neurons, astrocytes, or other cell types.

Infertility, including that resulting from medical intervention such as cytotoxic therapy of cancer patients, is of great concern. It is therefore gratifying to hear of the successful pregnancy outcomes of women who have received *ovarian* transplants. More recently several women have been successfully transplanted with a *uterus* donated by their mothers or a close relative. Cryopreservation of *sperm* is a successful strategy in the management of adult male cancer sufferers to protect the sperm from mutagenic cancer treatment. This is not available to prepubertal boys, but an alternative for them is cryopreservation of their *spermatogonial stem cells* for reintroduction post-treatment, as the Sertoli cells that support differentiation into mature spermatozoa will function normally. There is a potential for identifying and correcting genetic defects in the spermatogonia before their reintroduction, but ethical committees fight shy of this sort of “Frankenstein” tinkering. More acceptably, in cases of male infertility due to dysfunctional Sertoli cells, it should be possible to develop mature spermatids by culture of the spermatogonia with Sertoli cells derived from a normal individual.

A small number of individuals have received *hand* or *face* transplants, but these types of procedures throw up substantial surgical and ethical problems and are still at an early stage of development.

Substantially more common, of course, is coronary bypass surgery, which involves autografting with the saphenous vein from the leg, the internal mammary arteries, or the radial artery from the arm. The *blood vessel* is grafted onto the heart to bypass a blocked or damaged coronary artery. Vascular grafts in other areas of the body can employ synthetic blood vessels, made of materials such as Dacron or polytetrafluoroethylene (PTFE), autografts or, very rarely, allografts. Work proceeds on the generation of engineered blood vessels, for example by using human stem cells grown on biodegradable fibronectin-coated polymer scaffolds in the presence of appropriate mediators such as vascular endothelial growth factor.

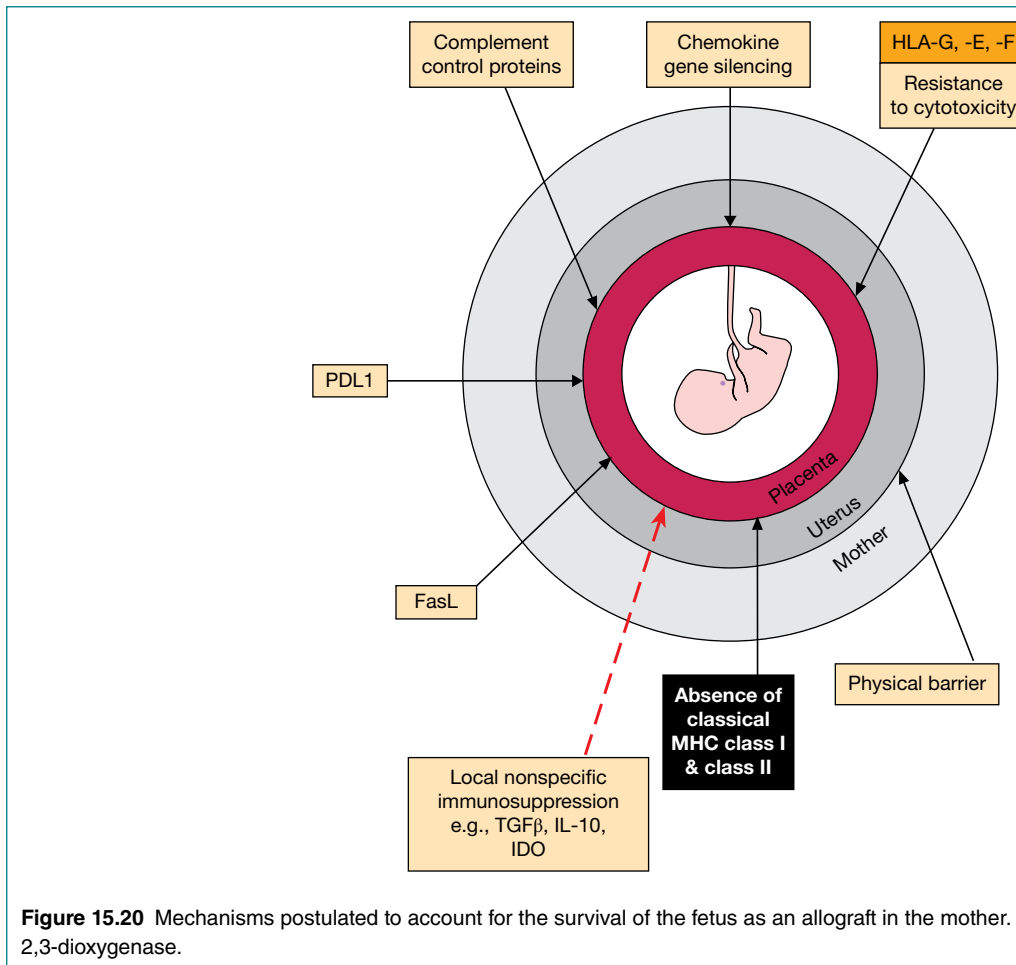
The fetus as an allograft

A consequence of polymorphism in an outbred population is that mother and fetus will almost certainly have different MHCs. In the human hemochorial placenta, maternal blood with immunocompetent lymphocytes circulates in contact with the fetal trophoblast and we have to explain how the fetus avoids allograft rejection, despite the development of an immunological response in a proportion of mothers as

evidenced by the appearance of anti-HLA antibodies and cytotoxic lymphocytes. In fact, prior sensitization with a skin graft fails to affect a pregnancy, showing that trophoblast cells are immunologically protected; indeed, they are resistant to most cytotoxic mechanisms although potentially susceptible to IL-2-activated NK cells. Some of the many speculations that have been aired on this subject are summarized in Figure 15.20.

Undoubtedly, the most important factor is the well-documented lack of both conventional class I and class II MHC antigens on the placental syncytiotrophoblast and cytotrophoblast that protects the fetus from allogeneic attack. These fundamental changes in the regulation of MHC genes also lead to the unique expression of the nonclassical HLA-E, -F, and -G proteins on the extravillous cytotrophoblast. These molecules, which show very limited polymorphism (15, 22, and 50 genomic sequence variants encoding just 6, 4, and 16 protein variants, respectively, have been described for HLA-E, -F, and -G), may protect the trophoblast from killing by uterine endometrial NK cells that would normally attack cells lacking MHC class I molecules. Maternal IgG anti-paternal MHC is found in 20% of first pregnancies and this figure rises to 75–80% in multiparous women. Some of these antibodies cross-react with HLA-G, but the vulnerability of the trophoblast cells to complement is blocked by the presence on their surface of the control proteins that inactivate C3 convertase. Mice in which the gene for the Crry complement regulatory protein has been knocked out develop placental inflammation and fetal loss. Immunohistochemical analysis revealed a deposition of complement components in the placenta of these mice, but if they were bred with mice in which complement component C3 has been knocked out then the detrimental effect of the absence of Crry was abrogated. This clearly indicates a role for inhibition of complement activation as one of the mechanisms that helps maintain the semi-allogeneic fetus, at least in mice. The presence of Fas-ligand at the trophoblast maternal–fetal interface may contribute towards limiting immunological aggression towards the fetus, although the fact that *gld* mice that lack FasL and *lpr* mice that lack Fas give birth to live offspring suggests that this mechanism is not essential for the maintenance of pregnancy. Likewise the presence of programmed death ligand 1 (PDL1) on syncytiotrophoblast cells is noteworthy. Suppression of T-cell, B-cell, and NK cell activity also occurs through the generation of toxic tryptophan metabolites by the catabolic enzyme indoleamine 2,3-dioxygenase, which is present in trophoblast cells and macrophages.

Cytokines seem to have a complex role in post-implantation pregnancy given the production of growth factors such as CSF-1 and GM-CSF, which have a trophic influence on the placenta, and of transforming growth factor- β (TGF β), which could help to damp down any activation of NK cells by potentially abortive events such as intrauterine exposure to lipopolysaccharide (LPS) or to interferons. Indeed, production of immunosuppressive IL-10 and TGF β by regulatory T-cells may play a central role in limiting any immunological attack on the fetus. Cells bearing the hallmark of naturally occurring



regulatory T-cells (i.e., $CD4^+CD25^+CTLA-4^+GITR^+FoxP3^+$ cells) are present in increased numbers, both in the circulation and in the decidua, during the first and second trimester of human pregnancy. The absence of such T-regulatory cells has

been shown to result in immunologically mediated rejection of the fetus in mice. It has also been proposed that, at least in mice, chemokine gene silencing in decidual stromal cells limits infiltration by Th1 and Tc1 cells.

Graft rejection is an immunological reaction

- It shows specificity, the second set response is brisk, it is mediated by lymphocytes and antibodies specific for the graft are formed.

Genetic control of transplantation antigens

- In each vertebrate species there is a major histocompatibility complex (MHC) that is responsible for provoking the most intense graft reactions.
- Parental MHC antigens are co-dominantly expressed on cell surfaces.
- Siblings have a 1 : 4 chance of identity with respect to MHC.

Other consequences of MHC incompatibility

- Class II MHC molecules provoke a proliferative mixed lymphocyte reaction when genetically dissimilar lymphocytes interact.

- Class II differences are largely responsible for the reaction of tolerated grafted lymphocytes against host antigen (graft-versus-host [GVH] reaction).

Mechanisms of graft rejection

- Preformed antibodies cause hyperacute rejection within minutes.
- CD8 and CD4 lymphocytes, antibody, and complement all play a role in the acute rejection that can occur several days after transplantation.
- The strength of allograft rejection is due to the surprisingly large number of allospecific precursor cells that directly recognize allo-MHC (the direct pathway); later rejection increasingly involves allogeneic peptides presented by self MHC (the indirect pathway).
- Chronic rejection can occur months or years after the transplant and may involve lymphocytes, phagocytes, antibody, and/or complement.

Prevention of graft rejection

- Rejection can be minimized by cross-matching donor and graft for ABO and MHC tissue types. Individual MHC antigens are typed by serological or molecular genetic techniques. HLA-DR, -A, and -B are the most important to match.
- Agents producing general immunosuppression such as antimetabolic drugs (e.g., azathioprine), anti-inflammatory steroids, and anti-lymphocyte monoclonals can block graft rejection. Cyclosporine, tacrolimus, and rapamycins represent T-cell-specific drugs; complexes of cyclosporine and tacrolimus, with their cellular ligands (cyclophilin A and FKBP, respectively), block calcineurin, a phosphatase that activates the IL-2 transcription factor NFAT, while rapamycins (which also complex with FKBP) inhibit the mTOR kinase involved in cell proliferation.
- Experimentally, antigen-specific depression through tolerance induction can be achieved with injection of allogeneic bone marrow with co-stimulatory blockade by anti-CD154 (CD40L) plus a CTLA-4-Ig fusion protein. Dendritic cell precursors can also induce tolerance through antigen presentation in the absence of B7 co-stimulators.

Xenografting

- Strategies are being developed to prevent hyperacute rejection of pig grafts in humans due to reaction of natural antibodies in the host with galactose α -1,3-galactose epitopes on pig cells and acute vascular rejection by acquired antibodies produced by the xenogeneic antibody response.

Stem cell therapy

- Stem cells can be isolated from various adult tissues and have the potential to provide material for autografts.
- Introduction of transcription factors into adult cells can be used to generate induced pluripotent stem cells.

Clinical experience in grafting

- Cornea and cartilage grafts are avascular, produce local immunosuppressive factors, and are comparatively well tolerated.

- Kidney grafting gives excellent results, although immunosuppression must normally continue throughout life.
- High success rates are also being achieved with heart and liver transplants. Lung is less successful. Isolated islets cells from the pancreas are increasingly being used for the treatment of patients with type 1 diabetes.
- Hematopoietic stem cell (HSC) grafts for immunodeficiency and aplastic anemia are accepted from matched siblings, but it is difficult to avoid GVH disease with allogeneic HSCs without first purging T-cells in the graft or preferably by inducing tolerance using co-stimulatory blockade. HSCs isolated from peripheral blood following mobilization of these cells from the bone marrow using G-CSF can be used instead of bone marrow.
- Transplantation of neural tissue has met with some success in patients with Parkinson's disease.
- Attempts at engineering tissues such as the trachea are increasingly successful.

The fetus as an allograft

- Differences between MHC of mother and fetus imply that, as a potential graft, the fetus must be protected against transplantation attack by the mother.
- A major defense mechanism is the lack of classical class I and II MHC antigens at the maternal–fetal interface.
- The placenta expresses the nonclassical MHC class I proteins HLA-G, HLA-E, and HLA-F, which may act to inhibit cytotoxicity by maternal NK cells.
- The trophoblast cells bear surface complement regulatory proteins that break down C3 convertase and so block any complement-mediated damage.
- Local production of IL-10 and TGF β by CD4⁺CD25⁺Foxp3⁺ regulatory T-cells, tryptophan degradation by indoleamine 2,3-dioxygenase, the presence of FasL and PDL1, and the silencing of chemokine genes may all contribute towards protection against unwanted reactions.



Now visit www.roitt.com to test yourself on this chapter.

FURTHER READING

Cornell L.D., Smith R.N., and Colvin R.B. (2008) Kidney transplantation: mechanisms of rejection and acceptance. *Annual Review of Pathology* **3**, 189–220.

Cooper D.K., Ekser B., Ramsoondar J., Phelps C., and Ayares D. (2016) The role of genetically engineered pigs in

xenotransplantation research. *The Journal of Pathology* **238**, 288–299.

Erlebacher A. (2013) Mechanisms of T cell tolerance towards the allogeneic fetus. *Nature Reviews Immunology* **13**, 23–33.

- Ford M.L. (2016) T Cell Cosignaling Molecules in Transplantation. *Immunity* **44**, 1020–1033.
- Hardinger K.L. and Brennan D.C. (2013) Novel immunosuppressive agents in kidney transplantation. *World Journal of Transplantation* **3**, 68–77.
- Johannesson B., Sui L., Freytes D.O., Creusot R.J., and Egli D. (2015) Toward beta cell replacement for diabetes. *EMBO Journal* **34**, 841–855.
- Kaplan B., Burkhart, G., Lakkis F.G., and Morris R. (eds.) (2011) *Immunotherapy in Transplantation: Principles and Practice*. Wiley-Blackwell, Oxford.
- Kiskinis E. and Eggen K. (2010) Progress toward the clinical application of patient-specific pluripotent stem cells. *Journal of Clinical Investigation* **120**, 51–59.
- Morris P. and Knechtle S.J. (2013) *Kidney Transplantation – Principles and Practice*, 7th edn. Saunders. London.
- Nankivell B.J. and Alexander S.I. (2010) Rejection of the kidney allograft. *New England Journal of Medicine* **363**, 1451–1462.
- Stegall M.D., Chedid M.F., and Cornell L.D. (2012) The role of complement in antibody-mediated rejection in kidney transplantation. *Nature Reviews Nephrology* **8**, 670–678.
- Suryavanshi D., Prabhakaran S., Matas A.J., and Humar A. (2013) Immunosuppression: use in transplantation. In *Encyclopedia of Life Sciences*. John Wiley & Sons, Ltd., Chichester. DOI: 10.1002/9780470015902.a0001242.pub3.

CHAPTER 16

Tumor immunology

Key topics

- Cellular transformation and cancer 459
- Cell-intrinsic mechanisms of tumor suppression 464
- Cell-extrinsic mechanisms of tumor suppression 465
- The cancer problem from an immune perspective 467
- Inflammation can enhance tumor initiation, promotion, and progression 472
- Tumor antigens 477
- Classes of tumor antigens 480
- Approaches to cancer immunotherapy 483
- Passive immunotherapy with monoclonal antibodies 483
- Unmasking of latent T-cell responses 486
- Antigen-independent cytokine therapy 488
- Vaccination approaches 489
- *Ex vivo* expanded lymphocytes or dendritic cells 492

Just to recap ...

In earlier chapters we have discussed how the immune system becomes activated in response to infectious agents that breach barrier tissues and mounts an appropriate response, via a combination of innate and adaptive components. As we have seen, central to the initiation of a robust immune response is the detection of nonself, initially in the form of pathogen-associated molecular patterns (PAMPs) that are sensed through binding to either soluble or cell-borne pattern recognition receptors (PRRs) on macrophages, dendritic cells (DCs), and other cells of the innate immune system. PAMP-mediated activation of DCs triggers their maturation and consequent migration to lymph nodes where they carry out a critical function as antigen-presenting cells (APCs), enabling T-cells to respond to nonself determinants in the form of foreign peptides. In this way, PAMP-mediated activation of the APCs of the innate immune system effectively licenses the cells of the adaptive immune system to respond to antigen. In the absence of this licensing, productive T- and B-cell activation do not take place, thereby minimizing the likelihood of autoimmunity and unwarranted immune responses. If productively activated, T-cells further differentiate to effector cells, coordinating B-cell responses, macrophage activation, and cytotoxic cell killing, in addition to other functions. In this way, the innate and adaptive arms of the immune system work cooperatively to identify and confront microorganisms. The immune system has evolved to discriminate self from nonself based upon the pragmatic principle that anything recognized as nonself may be dangerous and therefore warrants expulsion from the body. In the relentless pursuit of nonself our well-meaning immune systems sometimes work against us, rejection of transplanted organs being a case in point. But there are also situations where self may give serious cause for concern; cancer being the pre-eminent example of this. As we shall see, cancer all too frequently results in a situation where our immune systems are presented with a dilemma that, at best, leads to a failure of our immune forces to be immobilized in response to the threat and, at worst, to the immune system becoming recruited in favor of the tumor. Central to this dilemma is the absence of clear evidence, in the form of PAMPs, that an immune response is warranted. To compound matters further, cancers frequently behave similar to wounds, attracting the attentions of the immune system but receiving a helping hand rather than the hostile response that would be more appropriate.

Introduction

A major problem with cancer is that the immune system has considerable difficulty in mounting robust and/or sustained immune responses against such entities, largely because of the understandable preoccupation of our immune system with recognition of nonself. Because *the majority of cancers arise later in life*, whereas infectious agents pose a threat from the moment we are born, *our immune systems are*

much more geared towards recognizing nonself rather than altered self. This makes good sense as infection is a much more potent selective pressure, from a genetic perspective, than cancer as the latter generally does not prevent us from successful delivery of our genes into the next generation. Understandably, therefore, our immune systems have evolved to be much more focused on infection rather than mutation as a threat to our long-term survival.

Because tumors are self and are not typically associated with infectious agents (although there are some important exceptions to this, as we shall see), such cells lack PAMPs that are normally required to get robust immune responses off the ground. Thus, although the mutational processes associated with the development of cancer frequently generates *neoantigens* that, in principle, can elicit T-cell responses, in practice such responses are highly muted because of mechanisms that serve to prevent the emergence of autoimmunity. As a consequence, well-meaning regulatory T-cell responses and other mechanisms that serve to limit the development of autoimmunity (such as CTLA-4- and PD-1-mediated downregulation of T-cell responses) conspire to suppress the immune response against cancer. Moreover, tumors also actively manipulate the immune system to minimize immune responses that do emerge. Indeed, there is a growing body of evidence that tumors frequently recruit macrophages, neutrophils, as well as other innate immune cells and “re-educate” such cells towards a wound-healing phenotype for the purposes of supporting tumor growth and survival.

Another major impediment to the development of robust antitumor immune responses is the fact that tumors arise in a stepwise fashion, over long periods of time, which permits the selection of cells that are effectively invisible to the immune system. If they are not, such cells are weeded out by the immune system as the tumor develops. This process of *immunoediting* unfortunately selects for the “fittest” tumors that, by definition, are very difficult for the immune system to deal with. However, after many years of coming up empty-handed when trying to devise ways of overcoming all of the aforementioned obstacles to immunotherapy, the good news is that recent developments in the area of CTLA-4 and PD-1 antibody-based blocking strategies, as well as passive antibody-based immunotherapy against other tumor-associated markers, are finally yielding exciting therapeutic breakthroughs with many types of cancer. After many false dawns, cancer immunotherapy has truly arrived.

Cellular transformation and cancer

In simple terms, *cancer is a state where cells escape the normal controls that govern cell division and cellular longevity* among other things. Because our constituent tissues are made up of billions of cells that have long since given up the independence (but also the limitations) that go with being cellular sole traders, there are some hard and fast rules to live by. These rules govern cell division, cell lifespan, cell movement, and cell function.

Transformed cells break the rules governing multicellularity

One of the fundamental rules that cells within multicellular organisms have to observe is: ***do not divide unless given explicit permission to do so***. “Permission” in this context is granted in the form of ***growth factors*** that bind to cell surface receptors and ignite the chain of events that lead to the expression of the host of new gene products that are required to coordinate cell division and duplicate the entire contents of the cell. Tight control over cell division is maintained within complex organisms and this ensures that all organs reach a predictable size, which is achieved through regulating the supply of tissue-specific growth factors. In general, growth factors are supplied in a ***paracrine manner*** to ensure that cells are dependent on other cells to provide them with the permission to divide. As we shall see, cancers often overcome this restriction through acquiring the ability to make their own growth factors or through mutations that mimic signals provided by growth factors.

Another rule, which has few exceptions, is: ***stay in your own neighborhood***. Thus, a cell born in the skin, stays in the skin, a hepatocyte does not stray from the liver, and a cardiomyocyte stays in the heart; differentiated cells do not take vacations to other parts of the body. A very important exception to this rule is granted to cells of the immune system, which, by virtue of their role in sniffing out unwelcome guests, are granted permission to enter tissues and nose around looking for things that are out of place. But cells of the immune system are the exception, the vast majority of normal untransformed cells do not move out of their local environment; if they do, they typically die via apoptosis.

A third basic rule within multicellular organisms is: ***live for as long as you are efficiently performing your intended function***. Cells that become injured, infected or senescent are typically killed (or kill themselves via apoptosis) and replaced. Although it might seem harsh that cells within our bodies do not have pension plans, Nature knows a thing or two about survival of the fittest, and in the latter game, to fail to make tough choices is to risk losing the whole herd.

The aforementioned rules governing cellular societies ensure that cells within complex multicellular organisms function as a cooperative, dividing labor, maximizing efficiency, and maintaining their various specialized tissues at the required size. Of course, there are a series of complicated mechanisms, not all of which are fully understood, which ensure that all of the preceding rules are observed. However, there is no doubt that these governing principles have enabled the development of more and more sophisticated multicellular organisms, such as humans, that can pursue a less hazardous and more successful lifestyle than would ever be possible by functioning as single-celled organisms. Cancers are, by definition, made up of cells that break some or all of the above rules that govern cellular society. Such cells exhibit uncontrolled cell division, fail to do any useful job, live for much longer

than their normal counterparts, consume precious resources, and frequently invade other tissues, disrupting their function by competing for blood supply and nutrients. This selfish behavior makes cancerous cells a major threat to the survival of the whole multicellular enterprise and it is clearly highly desirable that such cells are identified and eliminated. Thankfully, there are a series of ***cell-intrinsic*** mechanisms, which we will discuss later, that serve to limit the development of cancers, with the immune system playing a ***cell-extrinsic*** role if these fail. Before we discuss these internal and external safeguards against cancer, let us examine the events that can lead to the development of cancer.

Cancer represents a spectrum of conditions rather than a single disease

Cancer is not a single disease but represents a wide spectrum of conditions caused by a failure of the controls that normally govern cell behavior in a complex multicellular organism. The major differences between cancer types largely stem from the unique character of their tissue of origin. Thus, there are considerable differences between cancers that originate in the skin versus the liver, lung, gut, or blood. Because each of these cell types have unique environments and gene expression signatures, the nature of the mutations that will enable each of them to disobey social controls on cell behavior will differ. Cancers can either be ***benign***, where the cancer fails to spread to other tissues, or ***malignant***, where the cancer is invasive and spreads to other tissues within the body. Cells that undergo ***malignant transformation*** escape these controls, invade surrounding tissue, and may ultimately migrate to other sites in the body to establish secondary tumors.

Although early theories on the nature of cancer proposed that abnormal cellular growths were caused by infectious agents, such as viruses, these theories were gradually supplanted by the idea that cancer was caused primarily by ***mutagens*** – agents that provoke genetic mutation. It is now well accepted that the majority of carcinogens (i.e., cancer-causing agents) act through provoking ***DNA damage*** either directly or indirectly. Such damage can be relatively subtle, resulting in point mutations that alter a single amino acid in the protein encoded by the affected gene, or more dramatic, provoking translocation of whole chromosomal segments from one chromosome to another (Figure 16.1).

The results of such mutagenic events are generally of little consequence, as the DNA damage will either be repaired or the cell will be killed via apoptosis. In a small minority of cases, however, mutagenic events can produce cells with properties that enable them to disobey the aforementioned rules that normally govern cell behavior in multicellular organisms. But this does not happen overnight, as the barriers to malignant transformation are formidable. It is important to stress ***that cancers almost never arise from single genetic lesions but rather progress in a series of steps from a normal untransformed state to a fully transformed one*** (Figure 16.2).

Frequently, the acquisition of particular mutations will predispose towards acquiring additional mutations by generating DNA instability. This progression is facilitated through the stepwise and random acquisition of a series of mutations that cooperate to produce the cancerous state. Because of the distinct selection pressures operating in different tissues, different

combinations of mutations are seen in cancers arising from different tissue types. In addition, although some of the same key genes (such as *P53*, *RAS*, *MYC*, *PTEN*, *RB*) are frequently mutated in a majority of cancers, these mutations can be accompanied by **a multitude (numbering in the hundreds) of additional mutations that are unique to an individual tumor**. The latter property presents a formidable challenge when attempting to identify tumor-specific antigens that are shared between many individuals for the purposes of boosting immune responses towards such tumors.

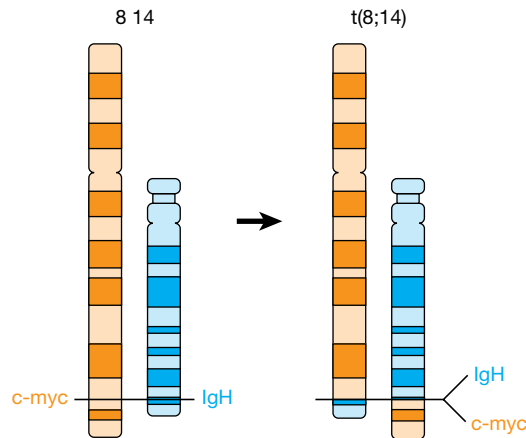


Figure 16.1 Translocation of the *c-myc* gene to the μ chain locus in Burkitt's lymphoma. Burkitt's lymphoma is a B-cell neoplasia with a relatively high incidence among African children in whom there is an association with the Epstein-Barr virus (EBV). In most cases studied, the *c-myc* gene, located on chromosome 8 band q24, is joined by a reciprocal translocation event to the μ heavy chain gene on chromosome 14 band q32, as depicted here. It is suggested that the normal mechanisms that downregulate *c-myc* can no longer work on the translocated gene and so the cell is held in the cycling mode. Less frequently, *c-myc* translocates to the site of the κ (chromosome 2) or λ (chromosome 22) loci.

Cellular transformation is a multistep process

Cellular transformation is a multistep process involving a combination of genetic lesions affecting genes that regulate, among other things, cell cycle entry, cell cycle exit, and cell death (apoptosis). Cancer is typically associated with **activating mutations** in genes that promote cell proliferation, such as *MYC* and *RAS*, which results in increased activity, stability, or expression of the protein products of these genes. Such genes, which in their hyperactive state promote the development of cancer, are called **oncogenes**. In tandem with this, **loss-of-function mutations** (where the function of the protein encoded by the gene is partly or fully lost) or **dominant-interfering mutations** (i.e., mutations that generate a protein that has lost its normal function and is also capable of inhibiting the activity of any remaining wild-type protein) in genes that promote cell cycle arrest or apoptosis of damaged cells, *P53* and *RB* being prime examples, are frequently observed. The latter genes are called **tumor suppressor genes** because, in their wild-type form, the products of such genes act to oppose the development of cancer. Deregulated expression of genes involved in the control of programmed cell death (such as

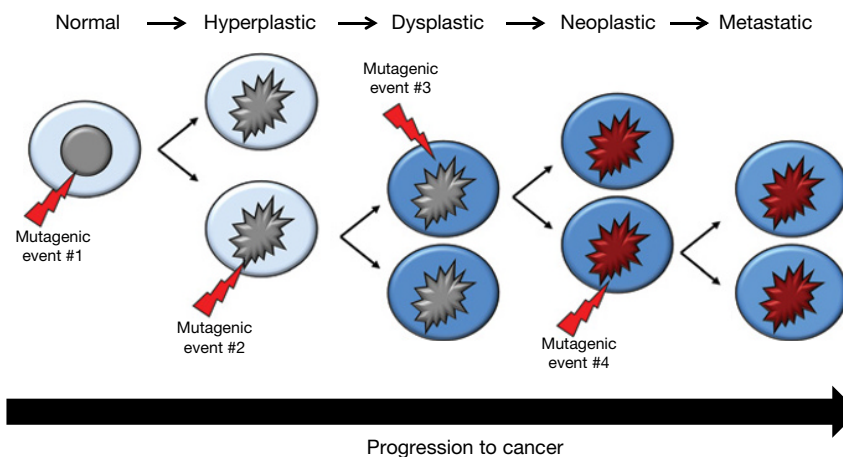


Figure 16.2 Cancer development is a multistep process. Cancers rarely arise from single mutations but occur as a result of the stepwise acquisition of multiple mutations that progressively transform a normal cell to a progressively more abnormal malignant one. At each step in the progression, transformed cells acquire characteristics (e.g., the ability to grow independently of growth factors, resistance to apoptosis, ability to invade surrounding tissues, adaptations that enable immune evasion) that endow them with a competitive advantage over neighboring cells and minimize detection and/or rejection by the immune system.

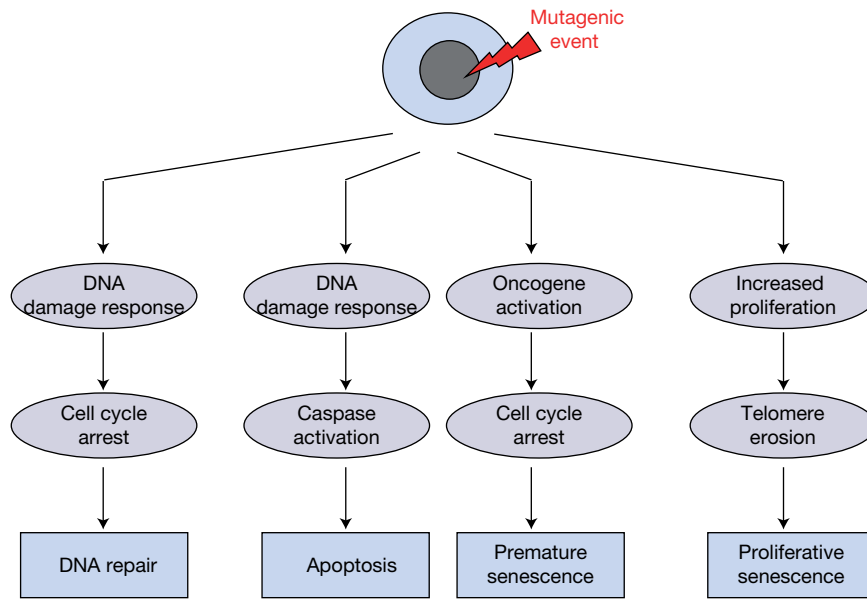


Figure 16.3 Cell-intrinsic mechanisms of tumor suppression. DNA damage normally activates a range of failsafe measures that result either in DNA repair, cell cycle arrest, apoptosis, or senescence of the affected cell. Such measures ensure that the vast majority of DNA damage-initiated mutations do not progress to cancer.

BCL-2 or *ABL*) is also a common feature of many malignancies. Thus, cancers are typically the outcome of cooperating mutations in oncogenes and tumor suppressor genes that synergize to produce the fully transformed state (Figure 16.3).

Some mutations promote cancer and many are simply inconsequential

It is important to note that most of the mutations that accumulate within a tumor are irrelevant and do not generate any functional advantage for the tumor. Such mutations are called **passenger mutations** and arise owing to other mutations (such as mutations in the DNA repair-related protein p53) that result in an increase in the rate of mutation, or a decrease in the rates of DNA repair. The key mutations that help to create the cancerous (i.e., transformed) state are called **driver mutations**. Driver mutations are those which drive cells towards the transformed state and are typically gain-of-function mutations in oncogenes (such as *c-Myc*, *Ras*, and *B-Raf*) or loss-of-function mutations in tumor suppressor genes that result in the transformed state. Such driver mutations have a functional impact on the development of tumors, whereas passenger mutations simply occur because of the inherent genetic instability of cancers. Thus, similar to the driver and passengers on a bus, it is the driver who decides where the bus is going rather than the passengers, who are simply along for the ride. One of the consequences of the appearance of passenger mutations in tumors is that many of these will generate **neoantigens** that will be unique to an individual and will not be shared between individuals with the same cancer. Indeed, recent genome-wide cancer sequencing initiatives have revealed that individual

tumors may have over 500 mutations that are unique to a particular tumor. Furthermore, sequencing of tissue from different areas of individual tumors has also revealed that considerable genetic heterogeneity exists even within the same tumor (Figure 16.4). This has serious disadvantages for the development of therapies based on boosting immunity against shared cancer neoantigens, as **most of the neoantigens that arise will not be shared among significant numbers of patients**, making them unattractive candidates for clinical trials. Indeed, many neoantigens will not even be shared by all cells within an individual tumor. However, as we shall see later, there are ways around this problem through re-activating immune responses in an antigen-independent manner.

Thus, **cancer arises as a consequence of a combination of driver gene mutations** that affect oncogenes and tumor suppressor genes and is a relatively low probability event as a consequence. Indeed, considering the trillions of cells an average human produces in their lifetime, our bodies are remarkably well adapted to limit the production of cells that manage to escape the normal controls governing cell proliferation. That said, given the almost 80-year lifespan of an average human, cancer does eventually occur in a significant percentage of individuals. Let us now look at some of the factors that affect the incidence of cancer development.

Cancer incidence varies between tissues

Cancers can arise from almost any tissue in the body but are most commonly found to occur in epithelia – the sheets of cells that form the upper layer of the skin and that line the walls of cavities and tubes within the body. Cancers that arise from

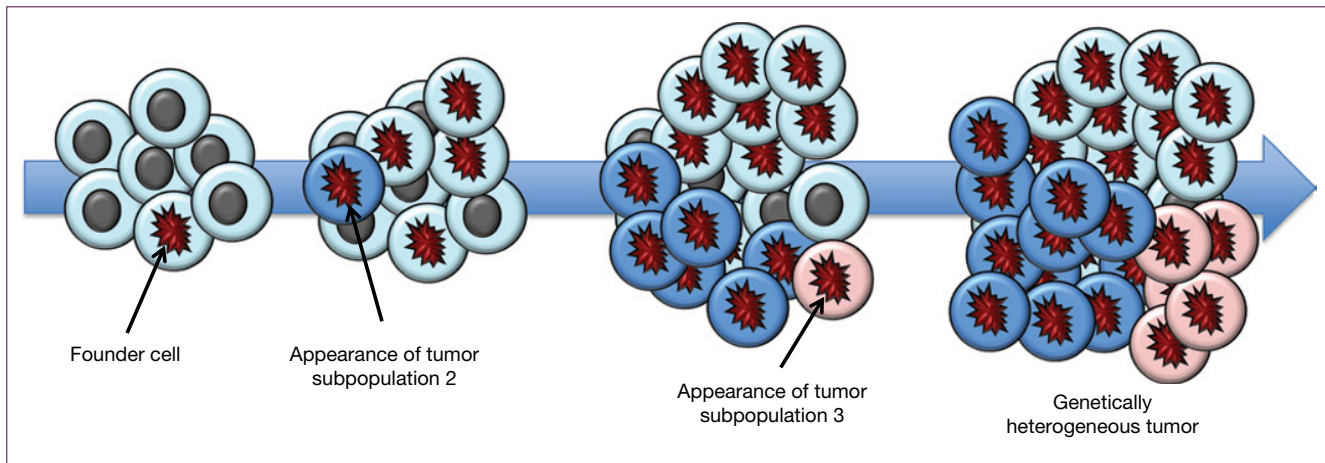


Figure 16.4 Solid tumors display considerable genetic heterogeneity. As a result of their inherent genetic instability, as cancers grow, genetic variants in the population will arise because of the acquisition of additional passenger or driver mutations that are not shared by all cells of the tumor. Furthermore, stresses such as nutrient deprivation, oxygen deprivation, and immune attack, which may not affect all cells within the tumor equally, will also positively select cells within the tumor that are capable of surviving these stresses. Owing to this genetic variation, tumors will frequently represent a mosaic of genotypes with considerable variation in the range of mutations that are present, even in different parts of the same tumor. This poses considerable problems for the identification of “neoantigens” that are shared by all cells within the tumor.

epithelia are called *carcinomas* and these tumors are responsible for more than 80% of all cancer-related deaths in the Western world. This is probably related to two factors: first, epithelia are at the highest risk of exposure to cancer-causing agents (*carcinogens*) because they line the surfaces of the body that are in direct contact with the environment (e.g., skin, lungs, mouth, esophagus, stomach, intestine, urinary tract, cervix). The environment is a major source of carcinogens, which can be either chemical, physical, or biological in nature. The other major factor governing the high probability of cancer arising in epithelium is the high replacement rate of epithelial cells as a consequence of damage or infection, which means that such cells are constantly dividing. Cancers arise more frequently in tissues that exhibit a high rate of mitosis probably because these cells are already dividing at a relatively high rate and the barriers to cell division are lower than in nondividing (i.e., post-mitotic) tissues. Because dividing cells need to replicate their genomes, a process that can itself be a source of mutation because of errors made by DNA polymerase, such cells can be a source of genetic instability.

The remaining malignant tumors arise from non-epithelial tissues throughout the body. Those that arise from the various connective tissues, called *sarcomas*, account for 1% of the tumors encountered in cancer clinics. The second group of tumors of non-epithelial origin arise from the various cell types that constitute the blood-forming (i.e., hematopoietic) tissues and include the cells of the immune system. Such tumors, called *hematopoietic malignancies*, include the *leukemias and lymphomas* and these account for approximately 17% of cancer-related deaths. The final group of non-epithelial tumors arise from various components of the central (i.e., brain) and peripheral nervous systems (i.e., spinal cord and outlying nerve

tissue) and are termed *neuroectodermal tumors*. These account for approximately 2.5% of cancer-related deaths.

Depending on their tissue of origin and transformation stage, cancers may grow slowly, or rather rapidly, they may be poorly metastatic or highly aggressive, some cancers are relatively responsive to therapy, while others are refractory and refuse to give in to even the most protracted assaults. Cancer therapy typically involves surgery (for solid tumors) followed by cytotoxic drugs or radiation, either alone or in combination, to kill the errant cells, while sparing as many normal (nonmalignant) cells as possible. It is the latter consideration that typically sets a limit on how much radiation or cytotoxic drug can be used in the hope of eradicating the tumor burden.

Mutagenic agents, including viruses, can provoke cellular transformation

As discussed earlier, cancer most frequently arises as a result of the accumulation of random mutations that affect genes that govern the rates of mitosis, apoptosis, and other cellular functions. Almost all carcinogens are mutagenic agents, that is, agents that cause gene mutations. Thus, tissues that commonly experience the highest levels of exposure to carcinogens are also at the highest risk of mutation. Because epithelial tissues are continually exposed to substances that may contain carcinogens (e.g., the air we breathe, the food we eat, the liquids we drink, the viruses that infect us) it follows that cells in these tissues are at the highest risk of acquiring mutations that may result in cancer. However, because of DNA damage detection and repair mechanisms, as well as mechanisms to limit the ability of abnormal cells to replicate (including the simple elimination of these cells by apoptosis, as well as induction of a non-replicating state called

senescence) it is important to note that the vast majority of mutations do not result in cancer. However, when cancers do arise, they are most commonly found in epithelial tissues because, as mentioned above, these are at the greatest risk of damage or infection.

Viruses are also capable of causing cancer through insertion into the genome of their hosts. This can result in cancer in two different ways: first, the viral genome may carry a gene that enables the host cell to escape the normal controls placed upon it that restrict cell division and/or limit its lifespan, and second, the virus may integrate its genome close to a host gene that regulates proliferation and/or apoptosis and this can result in the aberrant expression of such genes.

Cell-intrinsic mechanisms of tumor suppression

Because uncontrolled growth of cells is such a potentially destructive force, there are a number of cell-intrinsic “failsafe” systems that serve to curb the likelihood of cellular transformation occurring (Figure 16.3 and Figure 16.5). These systems come into play when abnormal signals are generated within cells and typically “punish” such cells either through depriving them of the ability to divide, a state called replicative senescence (transiently in some cases or permanently in others), or through killing such cells outright. We shall now take a look at some of these natural cancer-restraining mechanisms, as these are of fundamental importance for suppressing the development of cancer.

Growth factors are essential for cell division

As we have alluded to earlier in this chapter, one of the most important limits on proliferation is that *all cells typically require signals from other cells (i.e., growth factors) to permit cell division to occur*. Therefore, for a tumor to develop, cells must acquire a continuous supply of growth factors, or become independent of the need for growth factor signaling. Tumors

typically achieve this through mutations that either amplify the expression of growth factor receptors (that can lead to constitutive activation of the receptor), through acquiring the ability to produce their own growth factors (i.e., autocrine stimulation), or through mutation of key signal transduction proteins in growth factor signaling cascades. A good example of the latter is Ras, which is found in mutant form in ~30% of human cancers. Ras mutations that offer tumors a proliferative advantage are typically gain-of-function mutations surrounding the Ras GTP-binding pocket that produce a constitutively hyperactive Ras protein, thereby mimicking the action of continuous growth factor receptor stimulation. Another good example is B-Raf, a downstream kinase target of Ras. Gain-of-function mutations in B-Raf, which typically increase the catalytic activity of this kinase 50- to 500-fold, are commonly seen in malignant melanoma. Many other oncogenic events act in a similar manner, uncoupling the normal requirement for growth factor receptor stimulation for cell division to take place. Fortunately, when such oncogenic events do occur, they frequently do not result in continuous proliferation as excessive growth signals are frequently sensed as abnormal and lead to *premature cellular senescence*, a state where cells become permanently arrested and are incapable of further division (Figure 16.3 and Figure 16.5). Oncogene-induced premature senescence is mediated, in part, through upregulation of cyclin-dependent kinase inhibitors, proteins that can interfere with the key enzymes involved in coordinating cell division.

Telomere shortening acts as a barrier to cellular transformation

All cells have a limited number of cell divisions they are capable of undertaking – “the Hayflick limit” named after Leonard Hayflick who first described it. This phenomenon results from problems with replicating the extreme tips of chromosomes (telomeres), which progressively shorten with each round of cell division. Telomere shortening is not a problem for a good

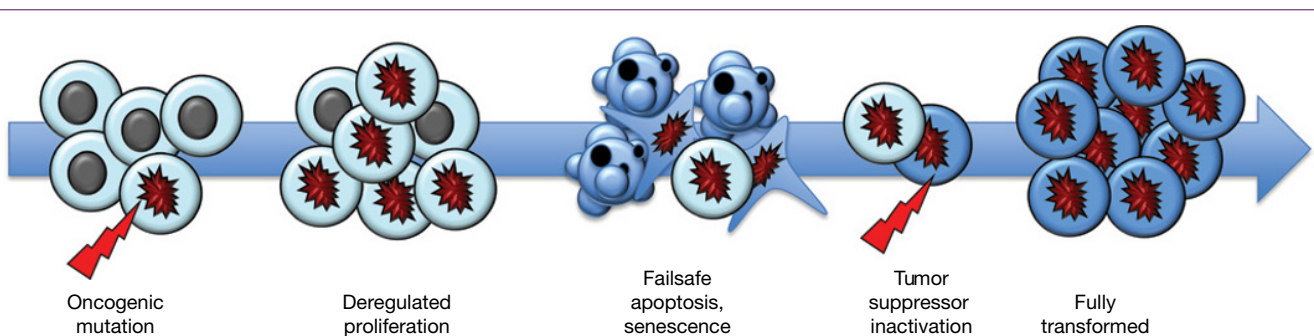


Figure 16.5 Cells must overcome the intrinsic barriers to tumor suppression to become fully transformed. Upon acquisition of oncogenic mutations that increase the rate of cell proliferation, premature cellular senescence and apoptosis become activated to eliminate or suppress the development of a tumor further. However, the appearance of additional mutations that inactivate key tumor suppressor genes, such as p53 or ARF, that are involved in the induction of apoptosis or senescence can lead to progression of transformed cells to the fully transformed phenotype.

number of cell divisions (~45–50 or so) because telomeres are composed of noncoding repetitive DNA that seems to be there for the purposes of protecting the coding regions of chromosomes. However, there comes a point at which telomeres have become so eroded that chromosomal ends begin to fuse together, and at this point cells cease to be able to divide, irrespective of whether they are receiving sufficient growth factor or downstream signals. Such cells are said to have entered **proliferative senescence** or to have reached their Hayflick limit and this acts as a natural barrier to the development of tumors (Figure 16.3). Where tumors do manage to overcome the Hayflick limit, this appears to be due to the re-activation of telomerase, an enzyme that is capable of repairing the ends of telomeres but that is not normally expressed in differentiated cells.

Tumor suppressor proteins monitor cell division

The products of **tumor suppressor genes**, such as p53 and pRb, act as another barrier to transformation. These gene products are involved in signaling networks that monitor the integrity of the genome, as well as confirming that the correct proliferative signals have been received before permitting entry into the cell cycle. In the event of DNA damage or aberrant mitogenic signals, the p53 and pRb tumor suppressor proteins can halt the cell cycle, which is either followed by DNA repair and cell cycle re-entry, permanent cell cycle arrest (senescence), or cell death via apoptosis (Figure 16.3; see also Videoclip 2).



Notwithstanding the various natural barriers to transformation, as discussed above, cancers clearly do occur as a result of cells managing to overcome these failsafe measures as a result of a series of acquired mutations. However, without the above countermeasures, cancer would undoubtedly be much more common than it already is. For example, individuals born with a single mutated *P53* allele (Li–Fraumeni syndrome) have a greatly increased lifetime risk of developing cancer, with some individuals developing several types of cancer concurrently. Similarly, inherited *RB* mutations also greatly increase the probability of developing certain tumors, such as retinoblastoma of the eye, a cancer from which this gene derives its name.

Cell-extrinsic mechanisms of tumor suppression

Having dealt with the **internal safeguards** that normally limit the development of cancer, let us now look at the external forces (i.e., mediated by other cells) that are likely to be helpful in this regard. Owing to the rather unlikely possibility that Nature foresaw the introduction of organ transplants into medical practice, it has long been conjectured that the highly efficient rejection of MHC-mismatched transplants by our immune system must have evolved for some other purpose. The ability to reject transplants of tissue may be traced back a long way down the evolutionary tree – back even as far as the annelid worms. Long before the role of MHC in immune responses was understood, Lewis Thomas suggested that the

allograft rejection mechanism represented a means by which the body's cells could be kept under **immunological surveillance** so that altered cells with neoplastic potential could be identified and summarily eliminated. Thus, the graft rejection response most likely represents an extreme example of an immunosurveillance system that normally serves to limit the development of cancer through recognition of “altered self” as opposed to nonself. So, what type of immune response is likely to be the most useful for the elimination of nascent tumors?

CTL and NK responses may be the most useful

Most of the weapons available to the immune system to confront microbial pathogens (complement, acute phase reactants, phagocytosis, production of reactive oxygen species, deployment of destructive proteases, antibody) are likely to be largely ineffective against transformed cells. This leaves us with two primary approaches at our disposal: natural killer (NK) cells and cytotoxic T-cells (CTLs). As discussed in Chapter 1, upon recognition of an appropriate target, NK cells and CTLs (or Tc cells) can utilize at least two main strategies to kill. First, they can degranulate the contents of their cytotoxic granules onto the target cell membrane to deliver their cell-killing granzymes inside with the help of the pore-forming protein perforin. Granzymes engage the cell death machinery within the target cell as discussed in Chapter 8. Second, CTLs and NK cells can also engage transformed cells via cell surface exposed Fas ligand (CD95L) that stimulates its cognate receptors on the tumor, again leading to apoptosis of the target cell. However, CTLs and NK cells utilize very different mechanisms in order to recognize transformed cells.

Requirements for NK cell-mediated killing

An ideal scenario would see a tumor failing to express the normal complement of MHC molecules. This would attract the attentions of NK cells, and indeed, this probably happens as transformed cells arise, leading to NK cell-mediated attack followed by death of the nascent tumor. Another way in which transformed cells may attract the attentions of NK cells is through upregulation of the expression of nonclassical MHC molecules (such as MICA and MICB) that also serve as ligands for activating NK receptors. Recall from our discussion of NK receptors in Chapter 4 that the expression of nonclassical MHC molecules can be upregulated in response to viral infection, as well as DNA damage and other forms of cell stress. Thus, stresses that are encountered in the tumor microenvironment, or DNA damage that arises because of the process of cellular transformation itself, may lead to the expression of such nonclassical MHC molecules, leading to NK-mediated attack. However, as we will discuss more fully later, unless NK-mediated attack succeeds in wiping out all of the transformed cell population, the ongoing process of NK-mediated culling can result in the selection of survivors with relatively normal patterns of MHC molecules. The latter cells eventually repopulate the tumor and, if this scenario does arise, the resulting tumor may be relatively impervious to NK-mediated killing.

Requirements for CTL-mediated killing

Moving on to CTLs, let us first remind ourselves that such cells require the appearance of an MHC-binding peptide that is recognized by a T-cell receptor. To fulfill this requirement, at some point on the road to transformation **the tumor would need to produce a new epitope** (i.e., a neoepitope), either as a consequence of mutation or expression of a novel protein that was not subject to central tolerance during T-cell selection. To elicit a strong CD8⁺ or CD4⁺ T-cell response, the latter neoepitope would need to bind with high affinity to MHC and, crucially, **be successfully presented in the context of the appropriate co-stimulatory molecules** (i.e., CD28 ligands B7-1/B7-2). This would enable the selective T_c-mediated killing of tumor cells bearing the neoepitope. However, the problem with the latter scenario is that **because of the requirement for DC maturation** (i.e., engagement of DC PRRs with a PAMP) to present antigen to naive T-cells, neoantigens are unlikely to elicit strong or sustained immune responses, even if they do arise in the first place. A caveat to this may be where sufficient tumor cells die as a consequence of selective pressures within the tumor microenvironment (such as hypoxia or nutrient deprivation due to a deficiency in the local blood supply). In the latter scenario, the **tumor may release sufficient damage-associated molecular patterns (DAMPs)** to activate local DCs that ingest the contents of dying tumor cells, leading to presentation of such antigens in a class II-restricted manner (Figure 16.6). Alternatively, ingestion of tumor antigens by a DAMP-activated DC may also lead to cross-presentation of tumor antigens on MHC class I molecules. In the former case,

the resulting CTLs will be CD4⁺ T-cells, whereas in the latter scenario the resulting CTL effectors will be CD8⁺ T-cells.

Tolerization of T-cell responses is problematic

A major obstacle to the development of productive T-cell-mediated antitumor immune responses, as mentioned earlier, is that the appearance of tumor antigens **in the absence of DC activation** will lead to tolerization of any T-cell responses that do emerge (Figure 16.6), or the suppression of such responses because of the co-emergence of regulatory T-cells. There is now considerable evidence to suggest that this is indeed what happens in the case of many solid tumors: T-cells responses are initiated but become **stood down because of engagement of CTLA-4 and/or PD-1 on T-cells**, either via ligands for the latter present on the tumor, or on cells within the tumor stroma. However, as we shall discuss later in this chapter, despite the failure of the immune system to eradicate tumors that manage to escape CTL-mediated killing, anergic T-cell populations can be successfully reawakened through lowering their threshold for activation. This can be achieved through **blocking immune checkpoint molecules** (such as CTLA-4 and PD-1) that are involved in the cell-intrinsic downregulation of immune responses, or cell-extrinsic regulation via Tregs.

Antibody-mediated responses can also be protective

Although CTL- and NK-mediated responses are probably by far the most useful responses for eradicating tumors, there is also some evidence that antibody responses may also be protective in

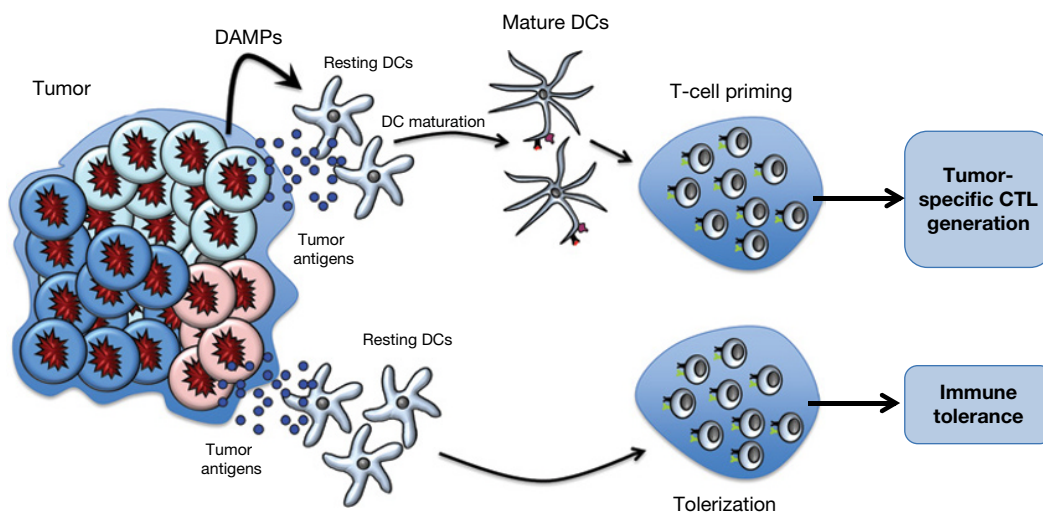


Figure 16.6 Tumor-derived damage-associated molecular patterns (DAMPs) may be critical to the instigation of robust immune responses against tumors. Because cancers typically lack nonself determinants in the form of PAMPs, cell death within the tumor bed, leading to the release of DAMPs, may play a critical role in the instigation of inflammatory and immune responses to transformed cells. DAMPs released from the dying tumors, in combination with tumor antigens, may be sufficient to activate local dendritic cells (DCs) and macrophages leading to T-cell priming against the presented tumor antigens. Conversely, DC uptake of tumor antigens in the absence of a DC maturation stimulus will either lead to T-cell anergy and/or the induction of Tregs against tumor-specific T-cells.

certain circumstances. First, in the context of passive immunotherapy (which we will deal with later in this chapter) therapeutic monoclonal antibodies targeted against cell surface-exposed tumor antigens may direct NK cells towards their targets and enable such cells to kill via antibody-dependent cellular cytotoxicity (ADCC). Alternatively, such antibodies may also block access of stimulatory ligands (such as epidermal growth factor [EGF]) to their cognate receptors that become amplified on certain tumors. However, there is also some recent evidence that **natural antibody responses generated by the host may enable DCs to capture antigens from the tumor** and, using these immunocomplexes, to present such antigens to appropriate T-cells to prime for efficient CTL responses. Furthermore, natural antibody responses that are generated towards tumor antigens would also be highly useful for enabling NK-mediated ADCC attacks, as well as for opsonizing tumor cells for uptake through phagocytosis via Fc γ receptor-bearing macrophages.



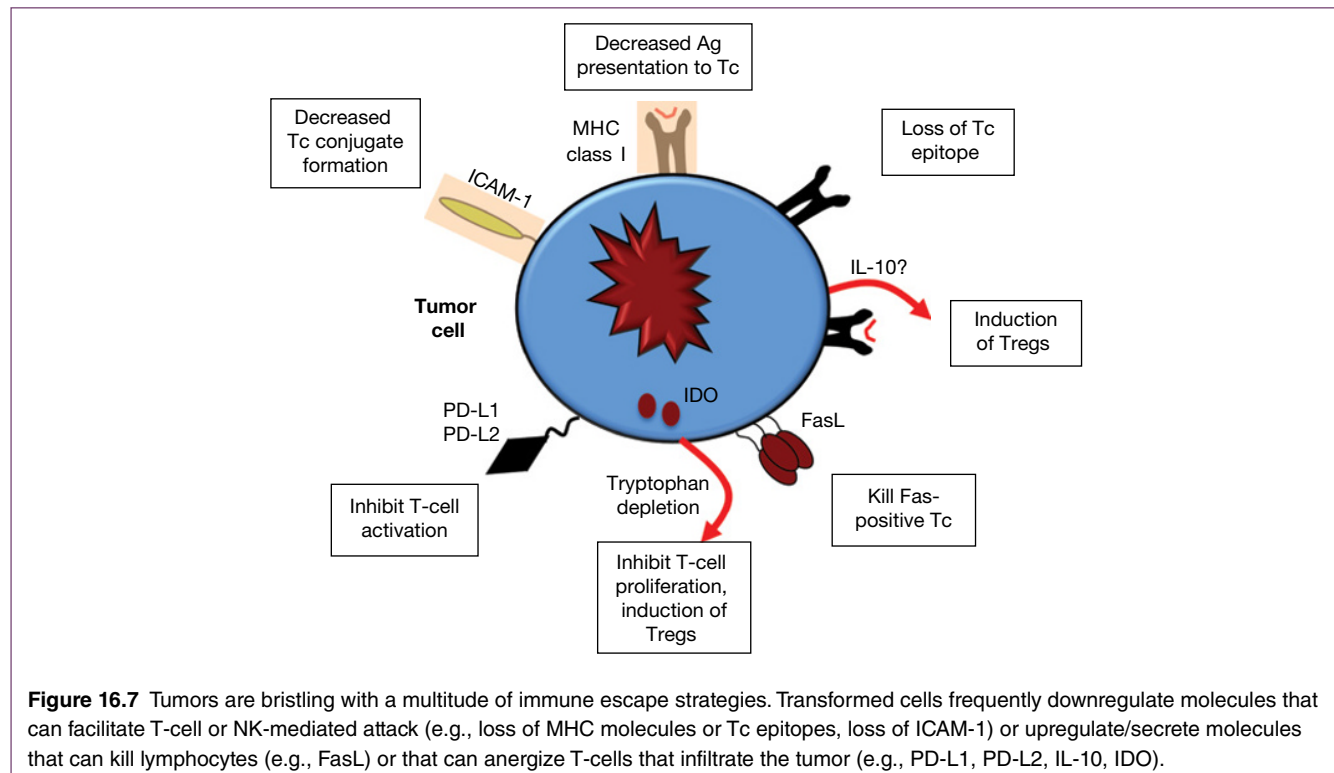
The cancer problem from an immune perspective

Having discussed the type of immune responses that can, in principle, stave off the development of cancer, let us now turn to the situation that pertains when cancers do manage to grow, despite the intrinsic and extrinsic safeguards discussed earlier. The fact that tumors all too frequently crop up means that such cells **either fly under the radar and completely avoid the attentions of the immune system, or acquire mutations or other adaptations that enable them to shake off these atten-**

tions if they do occur. Given the wealth of evidence that has now accumulated to demonstrate that transformed cells do employ a range of strategies to evade and manipulate the immune system, this strongly suggests that **immunosurveillance** does indeed play a role in the body's defenses against cellular transformation. Indeed, it could be said that tumors are positively brimming with various **immunological escape mechanisms** (Figure 16.7) and thus they resemble successful infections. We will now examine the major immune evasion strategies employed by tumors.

Cancers deploy multiple strategies to evade and repel immune attack

First, tumors frequently fail to grab the serious attention of the immune system because they are **highly similar to self**. As discussed earlier, because cancers are not infectious agents, they typically lack the molecular signatures (i.e., PAMPs) that normally enable the immune system to recognize that something is clearly amiss. This appears to be a big part of the problem and frequently results in tolerization of T-cells that could potentially recognize tumor antigens. Second, if strong nonself determinants (neoantigens) do arise during cellular transformation, these tend to be weeded out through immune-mediated killing of cells expressing such antigens; a process called **immunosurveillance** as will be discussed below. However, owing to the genetic instability and heterogeneity of tumors, as discussed earlier (Figure 16.4), it is highly unlikely that an immune response directed towards a single neoantigen



will be sufficient to wipe out all cells of the tumor, for the simple reason that ***not all cells of the tumor will express the same neoepitopes***. The surviving tumor cells will rapidly repopulate the tumor and will be impervious to immune attack unless they too express a decent neoepitope. A third problem is that tumors frequently deploy a battery of strategies to repel immune attacks in an active manner, through the secretion of factors (such as IL-10 or TGF β) or surface expression of molecules (such as CTLA-4 or PD-1 ligands) that ***switch off T-cell responses***. Fourth, tumors are also adept at taming the immune system and turning it to its own ends via the production of factors that ***re-educate tumor-associated innate immune cells to an immunosuppressive or wound healing-type mode***.

Therefore, ***cancers either fail to attract the serious and sustained attentions of the immune system, or generate an environment that is tolerogenic towards the tumor***. As we shall see, this tolerogenic state can either be passive, or can be maintained through the secretion of a variety of factors by the tumor that actively maintain this state. This is sometimes looked upon, anthropomorphically, as signs of fiendishly clever behavior on behalf of the tumor. However, it is a simple fact that cancers have one big weapon in their armory: time. In effect, cancers creep up on the immune system over long periods of time by being so similar to self, lacking clear signs of danger. They are sufficiently genetically plastic to allow negative selection (by the immune system) to weed out immunogenic cells, and also to positively select cells that can switch on natural immunosuppressive mechanisms that normally guard against the development of autoimmunity. Let us look at some of the issues in more detail.

Cancers lack PAMPs and contain few nonself determinants

The largely invisible nature of cancers, from the immune system's point of view, relates mainly to the fact that ***cancers represent self*** and are therefore devoid of PAMPs that are normally required for the initiation of effective immune responses. Because cancers are typically initiated by environmental factors (e.g., DNA-damaging agents and radiation) and typically do not have an infectious component, they usually fail to attract the attentions of the immune system to anything like the extent that PAMP-containing microorganisms do. As we shall see later, the exception to this general rule applies to cancers that are initiated by viruses (such as EBV, HBV, or HPV), which represent a minority of cases. In the absence of PAMPs to get adaptive immune responses up and running, the release of DAMPs as a consequence of cell death within the tumor is likely to play an important role in the activation of local APCs. Because rapidly growing tumors frequently experience nutrient and oxygen deprivation, as well as other stresses, most solid tumors do exhibit significant rates of cell death. Thus, tumor-derived DAMPs (such as members of the extended IL-1 family) may play a key role in the instigation of antitumor immune responses where they do occur.

Lack of co-stimulation can tolerize towards tumor antigens

Allied to the problem of the absence of nonself determinants is the fact that cells of the adaptive immune system do not typically enter peripheral tissues unless recruited there by cells of the innate immune system as a consequence of PAMP-initiated inflammatory responses. Therefore, even if a tumor does express one or more molecules not normally expressed in the body (e.g., because of a mutation that creates a new amino acid sequence), an adaptive immune response is unlikely to be initiated unless this molecule is somehow presented to the adaptive immune system in the context of the appropriate co-stimulation. This brings us back to the issue of PAMPs. Recall, that tissue-resident DCs are immature and do not migrate to lymph nodes to present antigen unless activated by a PAMP or another source of PRR stimulation. Therefore, a neoantigen generated by a tumor is likely to be ignored by the immune system unless presented by a mature DC; otherwise tolerization to this antigen will occur (Figure 16.6). Thus, much of the failure of the adaptive immune system to engage with tumors could be explained by either T-cell apathy or tolerance; tumors may create a micro-environment where ***tolerization*** of tumor-infiltrating lymphocytes occurs through failure of DCs to express the appropriate co-stimulatory molecules.

However, as noted earlier, tumors that release significant amounts of endogenous DAMPs may activate DCs and become subject to effective immune attack that may result in tumor rejection or immunoediting of specific subsets of the tumor (Figure 16.6). Conversely, tumors that fail to release DAMPs may be simply regarded as self and may fail to elicit significant immune responses. There are also other reasons why the immune system may become tolerant to a tumor. As will be discussed in detail later, tumors actively foster an immunosuppressive environment through the recruitment of multiple cell types into the tumor stroma that can actively manipulate immune responses. This includes macrophages and Tregs that are exploited by the tumor to create an immunosuppressive shield through the production of soluble factors such as IL-10 and TGF β .

Tumors express molecules that switch off T-cell responses

Although tolerance induction can occur by default, there is also ample evidence that tumors often actively tolerize DCs in the vicinity through the secretion of IL-10 and VEGF (vascular endothelial cell growth factor), as well as factors that can suppress T-cell activation, proliferation, and differentiation, such as TGF β (Figure 16.8). A key mode of T-cell tolerization in the tumor environment appears to be the surface display of ***PD-1 and CTLA-4 ligands*** that ***act as "off" switches for activated T-cells***, either through competing for CD28 binding on the T-cell (e.g., CTLA-4), or through actively suppressing T-cell signal transduction pathways via PD-1 (Figure 16.9). Recall from our discussion of CTLA-4 and PD-1 in Chapter 8 that both of

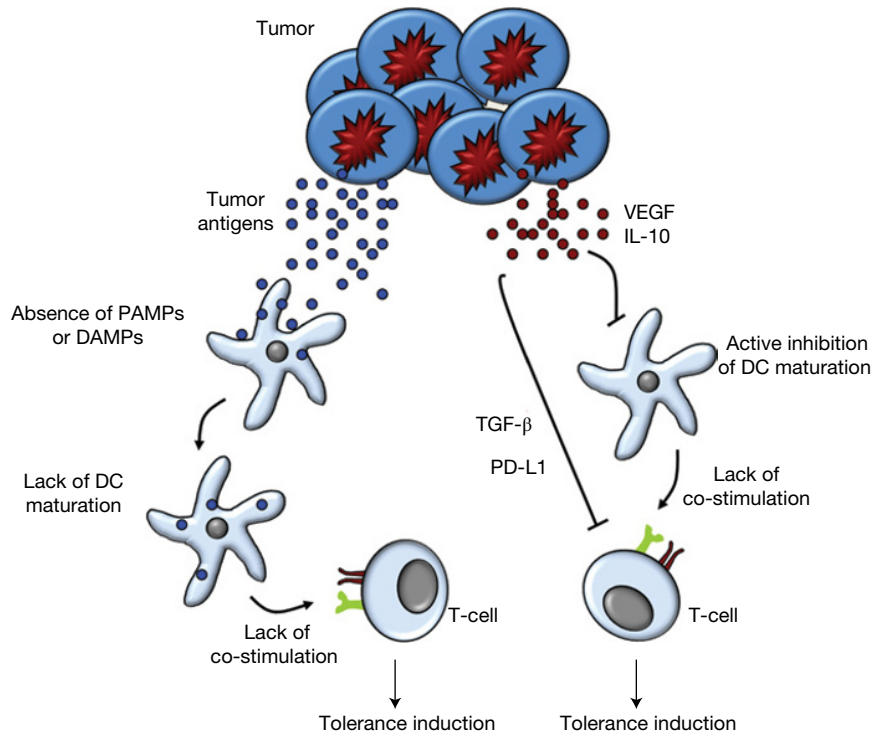


Figure 16.8 Tumors actively tolerize against tumor antigens. T-cell tolerance to tumor antigens can either occur passively, owing to the lack of PAMPs or DAMPs in the tumor environment to promote DC maturation and proper co-stimulation, or actively, owing to the secretion of factors (such as IL-10, VEGF, and TGF β) by the tumor that actively inhibit DC maturation or T-cell function. T-cell tolerization can also occur via expression of immune checkpoint molecules by the tumor that engage CTLA-4 or PD-1 molecules on T-cells (see Figure 16.9).

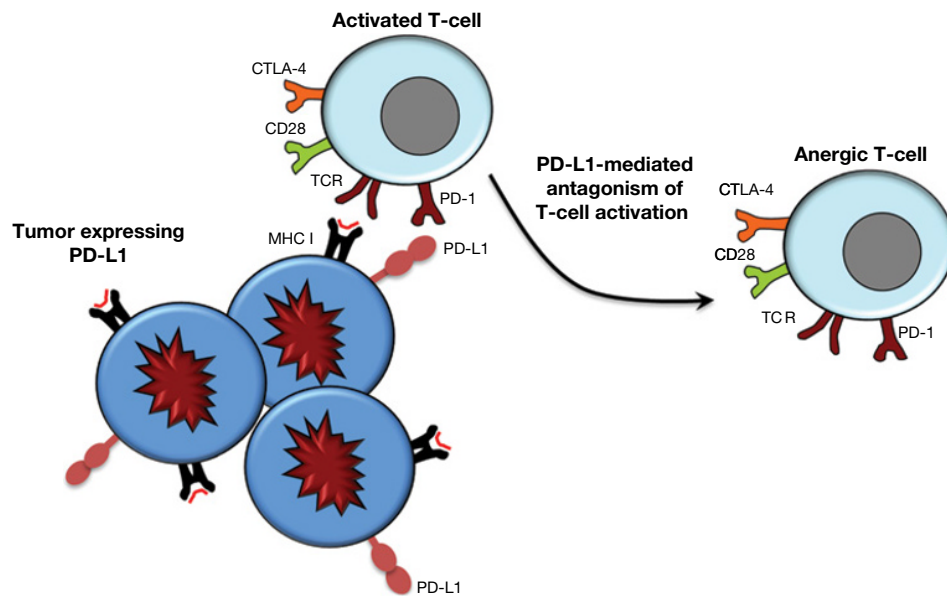


Figure 16.9 T-cell checkpoint molecules (CTLA-4, PD-1) are frequently engaged by tumors to suppress antitumor T-cell responses. Emerging evidence strongly suggests that tumors very frequently engage immune checkpoint molecules on T-cells, such as PD-1 and CTLA-4, which has the effect of energizing T-cells in the tumor environment. Fortunately, blocking antibodies against CTLA-4, PD-1, PD-L1, and PD-L2 can reactivate tumor-specific T-cells to treat a number of solid cancers.

these molecules are upregulated on activated T-cells and play an important role in terminating T-cell responses. Thus, the engagement of CTLA-4 or PD-1 by the tumor, or cells within the tumor stroma, represents a highly effective way of stifling emerging T-cells responses. However, as shall be detailed later in this chapter, antibody-mediated neutralization of PD-1 or of its ligands PD-L1 and PD-L2, or similar neutralization of CTLA-4, have proved effective in overcoming immunosuppression within the tumor environment. Indeed, as a result of highly promising results in clinical trials, several of these agents have now been approved for use in human cancer immunotherapy and hundreds of clinical trials are currently underway to evaluate similar **immune checkpoint**-blocking strategies.

Another important means of frustrating T-cell responses appears to be the **manipulation of the metabolic environment** within the tumor that leads to the depletion of the essential amino acid tryptophan, which is required for T-cell proliferation. Numerous studies have implicated the tryptophan catabolic enzyme **indoleamine 2,3-dioxygenase (IDO)**, as a central driver of tumor development and progression. IDO can be upregulated within cells of the tumor, as well as within the tumor stroma and immune cells recruited to the tumor, and helps to create an immune tolerant environment through its ability to suppress the proliferation of activated T-cells and NK cells that are preferentially sensitive to tryptophan depletion. Furthermore, IDO has also been implicated in the generation and activation of regulatory T-cells. IDO upregulation appears to occur in many tumors because of loss-of-function mutations in *Bmi1*, a tumor suppressor gene that is widely inactivated during tumor progression. In addition to depletion of tryptophan itself, tryptophan breakdown products, such as L-kynurenine (Kyn), are also thought to block T-cell activation and trigger T-cell apoptosis, while also promoting the emergence of Tregs (through a TGF β -dependent mechanism). Small molecule inhibitors of IDO exhibit anticancer activity and cooperate with immunotherapy, radiotherapy or chemotherapy to trigger rapid regression of aggressive tumors.

Tumors can also decrease their vulnerability to cytotoxic T-cell attack by expression of surface FasL and a growth inhibitory molecule, RCAS1, which react with T-cells bearing their corresponding receptors and stop them in their tracks. As we have already noted, tumors also secrete other immunosuppressive factors, such as TGF β and IL-10 (Figure 16.8). Such factors may help to keep burgeoning immune responses at bay **by inducing suppressor or regulatory T-cell populations** that inhibit responses to the tumor. Natural regulatory T-cells (Tregs) that normally guard against the development of autoimmunity also hamper robust T-cell responses against tumors. It should also be borne in mind that internal defects in the cell death machinery, which facilitated the establishment of the tumor in the first instance, may also render such cells resistant to the best efforts of cytotoxic T-cells and NK cells to eradicate them. The very existence of such “Houdini” mechanisms builds a case in favor of the notion that the adaptive immune system has a significant role in suppressing tumor growth.

Immunoediting and antigen loss subvert the development of strong T-cell responses

Subtle point mutations in oncogenes such as *RAS* that have profound effects on the function of the protein products of such genes and contribute to transformation, may completely fail to create any new epitopes that would result in immune attack. In a similar vein, complete loss of expression of important tumor suppressor genes, such as *P53* or *RB*, through nonsense mutations would also fail to create any new epitopes. Where the process of transformation does generate strong neoantigens, the antitumor responses that do arise are frequently blunted through **immunoediting** and **antigen loss**. This is most likely because during the course of cellular transformation, which may take many years, the tumor is placed under selective pressure by the host immune system. Because of the genetic plasticity of transformed cell populations, this will invariably lead to immune escape mutants that have lost or minimized the feature that the immune system is using to recognize the presence of the growing tumor mass (Figure 16.10). In this way, the immune system may exert a Darwinian selective pressure for cancer-causing mutations that are largely immunologically silent: a process that has been termed **immunoediting**. For example, it has been found that experimentally induced tumors in mice are less immunogenic if these have been grown under immune pressure. However, if the same tumors are initially grown in immunodeficient *RAG2*-null mice, followed by transplantation into naive wild-type mice, 50% of these tumors fail to grow as compared to 100% if initially grown in wild-type mice.

Loss of tumor antigen epitopes, where they do arise, represents another escape mechanism and mutations in an oncogenic virus itself can increase its tumorigenic potential. Thus the frequent association of a high-risk variant of human papillomavirus with cervical tumors in HLA-B7 individuals is attributed to the loss of a T-cell epitope that would otherwise generate a protective B7-mediated cytolytic response. In addition to antigen loss, tumors may become less immunogenic under pressure from the immune system through downregulation of MHC molecules that present particular antigens, or through mutations that alter antigen processing for MHC presentation. Downregulation of HLA class I molecules to make the tumor a less attractive target for cytolytic T-cells is a favorite ploy. This is a common feature of breast cancer metastases, and this is true also of cervical carcinoma where, prognostically, loss of HLA-B44 in premalignant lesions is an indicator of tumor progression. Rather than lose expression of all class I molecules and risk attracting the attentions of NK cells, tumors may lose just the expression of class I alleles that are capable of presenting antigenic peptides to T-cells.

The **immune surveillance theory** would predict that there should be more tumors in individuals whose adaptive immune systems are suppressed. This undoubtedly seems to be the case for **strongly immunogenic tumors**. There is a considerable increase in skin cancer in immunosuppressed

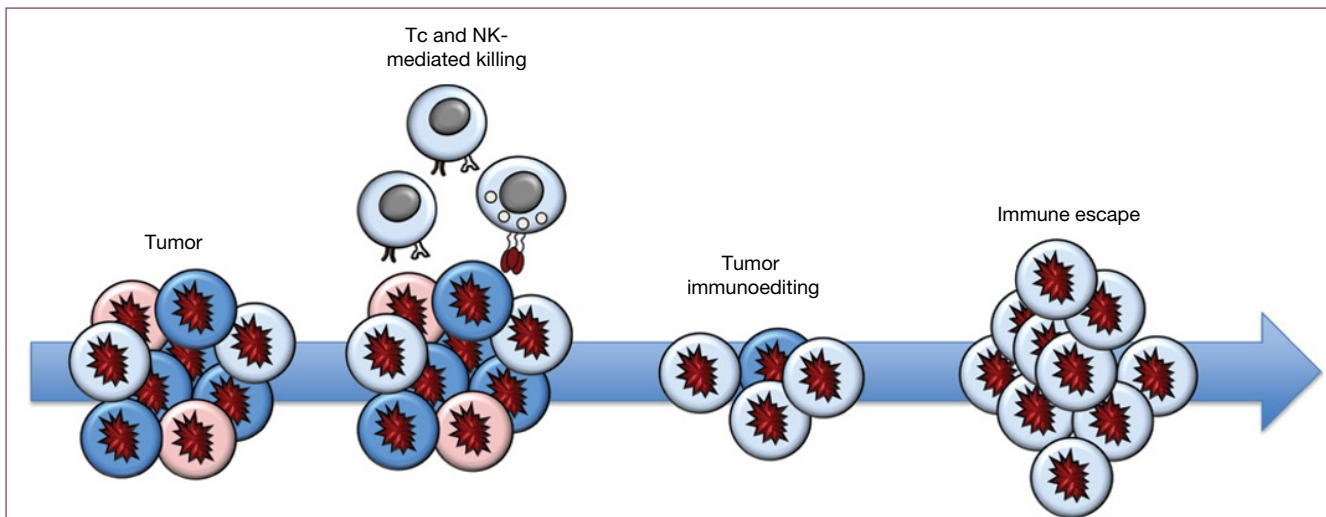


Figure 16.10 Immunoediting can lead to the selection of weakly immunogenic tumors. Antitumor immune responses that arise during the early stages of cancer are frequently blunted through immunoediting by Tc and NK cells that recognize strong tumor antigens. Because of the genetic plasticity of transformed cell populations, immunoediting invariably leads to the selection of immune escape mutants that have lost or minimized the feature that the immune system is using to recognize the presence of the growing tumor mass. Thus, the immune system exerts a Darwinian selective pressure for further mutations that are largely immunologically silent; a process that has been termed immunoediting.

patients living in high sunshine regions north of Brisbane and, in general, transplant recipients on immunosuppressive drugs are unduly susceptible to skin cancers, largely associated with papillomavirus, and EBV-positive lymphomas. The EBV-related Burkitt's lymphomas crop up with undue frequency in regions of high malarial infection, which is known to compromise the efficacy of the immune system. Likewise, the lymphomas that arise in children with T-cell deficiency linked to Wiskott–Aldrich syndrome or ataxia telangiectasia express *EBV* genes. These show unusually restricted expression of EBV latent proteins that are the major potential target epitopes for immune recognition, while cellular adhesion molecules, such as intercellular adhesion molecule-1 (ICAM-1) and lymphocyte function-associated molecule-3 (LFA-3), which mediate conjugate formation with Tc cells, cannot be detected on their surfaces (Figure 16.7). Knowing that most normal individuals have highly efficient EBV-specific Tc cells, this must be telling us that only by downregulating appropriate surface molecules can the lymphoma cells escape even the limited T-cell surveillance operating in these patients.

Although successful adaptive immune responses may be overcome during the establishment of many tumors, this does not necessarily mean that the immune system cannot be manipulated to deliver an effective response. Indeed, as we shall see later, recent developments in the area of ***T-cell checkpoint inhibitors*** have shown very considerable promise in clinical trials and argue that immune response manipulation can effectively reawaken dormant tumor-specific T-cells.

Inflammatory responses can enhance tumor growth and confer resistance to immune attack

Although tumors can acquire adaptations that minimize their detection by immune cells, this is not to say that tumors are invisible to the immune system. Indeed, as will be discussed more comprehensively in the following section, tumors are frequently heavily infiltrated by ***tumor-associated macrophages (TAMs)*** and neutrophils but, paradoxically, such cells are frequently actively recruited by the tumor and can promote tumor proliferation and progression. Indeed, it is generally true to say that the presence of TAMs within a tumor is a bad prognostic indicator, as such cells are more often working for, rather than against, the tumor. As we shall see in the following section, the paradoxical effects of inflammation on the growth of tumors is related to a number of factors, including the production of cytokines and chemokines (such as IL-1, IL-6, and IL-8) that generate a supportive, wound-healing environment. These soluble mediators can recruit neutrophils and macrophages, which in turn produce additional cytokines, growth factors, and other soluble factors that promote proliferation of the tumor as well as the growth of new blood vessels (angiogenesis) that are required for rapidly proliferating cells. Macrophage density correlates with a poor prognosis in approximately 80% of cancers and there is now much evidence that tumors frequently “re-educate” macrophages through the provision of anti-inflammatory cytokines (such as IL-10 and TGF β) that can generate an anti-inflammatory environment within the tumor. This can lead to suppression of any T-cell responses that do emerge. Thus, the recruitment of macrophages

to tumors can generate an environment that conspires to help rather than fight the tumor. As if this were not already bad enough, there is increasing evidence that tumor-associated inflammatory cells, especially macrophages and neutrophils, can even promote the progression to malignancy and metastasis through the production of reactive oxygen and nitrogen species that can provoke DNA damage and thus generate additional mutations. Thus, tumors can manipulate cells of the immune system for their own ends, which further contributes to the difficulty of developing tumor immunity.

Inflammation can enhance tumor initiation, promotion, and progression

There is now considerable evidence that inflammation can promote tumor development as well as tumor progression and invasion. Indeed, it is becoming increasingly evident that ***an inflammatory environment is an essential component of all solid tumors***. Many environmental causes of cancer (tobacco smoking, asbestos, pollutants) or increased cancer risk (obesity, alcoholism, infection, autoimmunity) are associated with chronic inflammation. Initial evidence for a role for inflammation as a factor that can influence tumor growth came from studies which noted that postoperative infections in cancer patients frequently led to rapid growth of previously dormant metastases (i.e., secondary tumors) after surgical resection of the primary tumor mass. This was subsequently confirmed by LPS treatment of tumor-bearing mice, which showed that this had a significant growth-enhancing effect on the tumor as well promoting the establishment of metastases. It is now well

accepted that ***chronic infection and inflammation are among the most important epigenetic and environmental factors that can influence the establishment and progression of certain tumors***. For example, there is a significant association between long-term alcohol abuse – which leads to inflammation of the liver and pancreatic tissues – and cancers of the same organs. Similarly, inflammatory bowel disease is associated with an increased risk of colon cancer; chronic viral hepatitis is associated with liver cancer; *Helicobacter pylori* infection is associated with gastric cancer; asbestos and silica exposure are associated with persistent lung inflammation and lung cancer.

Although infection or autoimmunity can increase cancer risk, neither is an essential prerequisite for tumor-associated inflammation, as ***the conditions that accompany solid tumor formation almost invariably lead to the creation of an inflammatory milieu***. So why do solid tumors elicit an inflammatory response? This is probably because an inflammatory environment can be readily exploited by tumors for their own ends and, in tandem with positive selection of cells within the tumor capable of eliciting an inflammatory response (through secretion of chemokines for example), this culminates in the recruitment of cells of the innate immune system (Figure 16.11). Second, because as some point during solid tumor formation the tumor blood supply will inevitably become limiting as the tumor increases in size, significant amounts of necrotic cell death will take place within the tumor, resulting in the release of DAMPs. The latter event will effectively mimic sterile injury and will also contribute to the recruitment of innate immune cells to the tumor. As we shall see, inflammation plays a role in cancer initiation and progression through two major functions

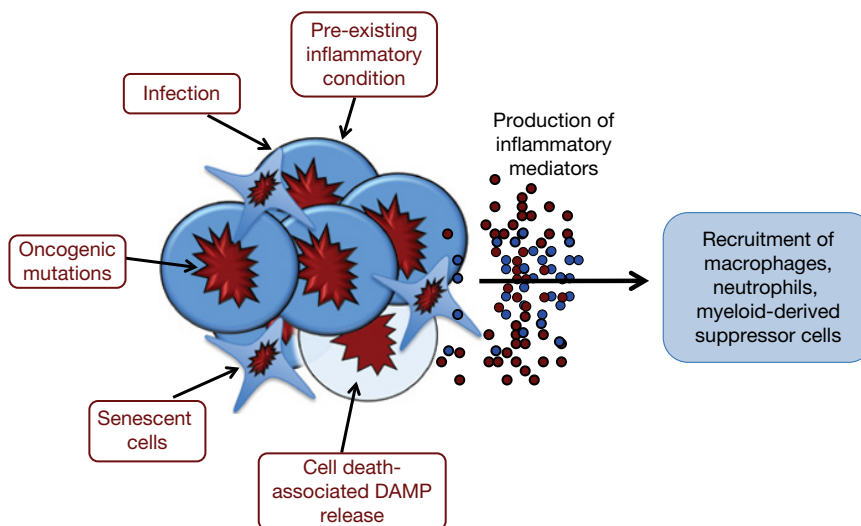


Figure 16.11 Inflammation within the tumor environment can be caused by multiple factors. Tumor-associated inflammation can be provoked by several factors including a pre-existing autoinflammatory condition (such as inflammatory bowel disease) or long-term inflammation provoked by infection or chemical/physical irritants. Inflammation can also occur post-tumor formation as a consequence of cell death-associated DAMP (damage-associated molecular pattern) release by the tumor, through oncogenic mutations (e.g., IRAK or Ras mutations) that upregulate inflammatory signaling within cells of the tumor, or as a consequence of DNA damage that provokes premature cellular senescence leading to cytokine production by the latter cells.

that cells of the innate immune system excel at: secretion of cytokines/chemokines/growth factors and the production of reactive oxygen and nitrogen species that are capable of causing DNA damage. There are two different scenarios to contemplate.

Where there is no pre-existing cancer, sustained and protracted inflammation (due to infection or autoimmunity or an environmental agent that triggers inflammation) can recruit cells of the innate immune system, such as neutrophils, that can contribute to DNA damage within the inflammatory site via the production of reactive oxygen and nitrogen species. This DNA damage can contribute to cellular transformation and, in tandem with soluble mediators (such as cytokines and growth factors) produced by other inflammatory cells, can produce the conditions leading to full-blown malignancy. In the other scenario, **where there is already a nascent or established cancer,** the production of macrophage and neutrophil recruiting factors (e.g., CSF-1, CCL2, IL-8) by the tumor or the tumor stroma can once again recruit innate immune cells to enable the tumor to benefit from the range of mitogenic, wound healing, and angiogenic factors that such cells are capable of producing. The latter factors, in combination with the aforementioned DNA-damaging species that neutrophils and macrophages produce, can help the tumor to further progress and become more aggressive through

acquisition of further mutations and a more robust blood supply. In both scenarios, cells of the innate immune system can also help to protect the tumor from any burgeoning T-cell responses through the creation of an immunosuppressive or tolerogenic environment within the tumor bed. Let us now take a closer look at some of these issues.

Inflammatory responses can enhance tumor growth and progression

Although we tend to think of immune responses as being destructive – probably not unreasonably when one considers that much of the early stages of an immune response is preoccupied with detecting and eliminating nonself entities – a significant and often overlooked function of the immune system is to restore normal tissue integrity after an infection has been resolved by promoting **wound healing**. To this end, macrophages and other innate immune cells secrete growth factors, such as TNF, IL-6, EGF family ligands, and other mediators, that can stimulate proliferation of local tissue and endothelium for the purposes of replacing cells killed during the acute stages of infection or after sterile injury (Figure 16.12). There is now much evidence that tumors, through recruitment

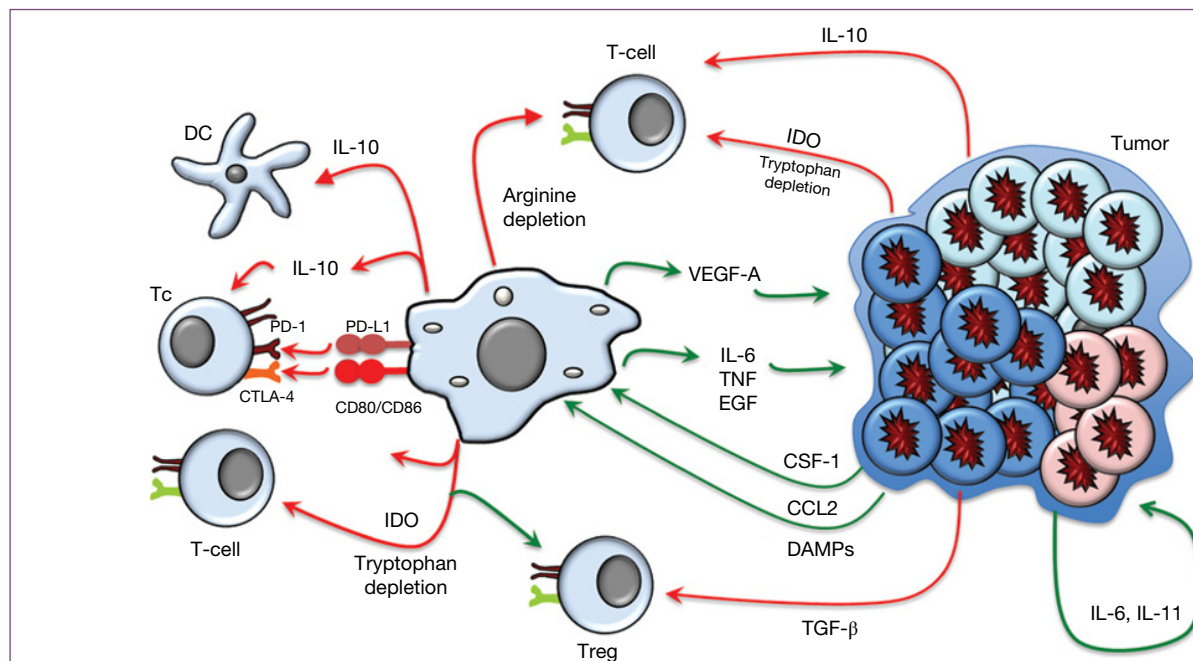


Figure 16.12 Tumor-associated macrophages (TAMs) frequently generate an anti-inflammatory environment within the tumor. Macrophages can be recruited to tumors through secretion of chemokines, such as CSF-1 and CCL2, or release of DAMPs by the tumor. Tumors also secrete other cytokines, such as IL-6 and IL-11, which can have autocrine proliferation-inducing effects on the tumor, as well as upregulate anti-apoptotic factors that can protect the tumor from stresses such as oxygen and nutrient depletion. TAMs can generate an immunosuppressive milieu in the vicinity of the tumor through a multiplicity of strategies, including production of IL-10, expression of IDO (indoleamine 2,3-dioxygenase) that can deplete tryptophan (which is required for T-cell proliferation), as well as encouraging the formation of Tregs, expression of immune checkpoint molecules (such as PD-L1/PD-L2, or CD80/CD86) that can engage PD-1 or CTLA-4 on infiltrating T-cells, and depletion of arginine via arginase (which is also required for T-cell proliferation). TAMs can also directly support tumor proliferation through secretion of EGF, IL-6, and other factors and can also facilitate angiogenesis to nourish the tumor via secretion of VEGF-A. Tumors also exert their own immunosuppressive effects via IL-10, TGF β , and IDO.

and “re-education” of inflammatory cells to a wound-healing phenotype, can harness the growth-stimulating properties of such cells to subvert the actions of the innate immune system. In this way, tumors pose as “wounds that never heal” and use the tissue repair functions of the immune system for a purpose that was never intended. For example, TNF production in the tumor microenvironment can stimulate TNF receptor-positive tumor cells, leading to activation of the NFκB transcription factor. This can have two major consequences: on the one hand, NFκB can promote expression of additional cytokines, such as IL-1 and IL-6, which can have autocrine growth-promoting effects on the tumor, and on the other hand, NFκB activation can lead to expression of multiple apoptosis-inhibitory molecules within the tumor that may render such cells more difficult to kill. The tumor reaps multiple benefits from the combined effects of TNF exposure. In such situations, treatment with neutralizing anti-TNF antibodies may be of therapeutic benefit. Similarly, inhibitors of NFκB are also under evaluation as potential chemotherapeutic drugs.

Another beneficial effect of the recruitment of innate immune cells to tumors is the acquisition of an enhanced blood supply. Upon recruitment to hypoxic regions, as is often found in solid tumors, macrophages can switch on an angiogenesis program, resulting in the secretion of factors such as VEGF-A that can trigger the sprouting of new blood vessels (Figure 16.12). IL-8 has also been frequently implicated in promoting a proangiogenic environment within tumors.

Sources of tumor-associated inflammation

It will be obvious that infectious agents, through their associated PAMPs, can directly engage PRRs, leading to cytokine and chemokine production and an influx of innate immune cells into the tissue. We will shortly deal with how sustained inflammation of this sort can lead to DNA damage and transformation, but how do tumors generate an inflammatory environment in the absence of infection or a pre-existing inflammatory condition?

It is now becoming increasingly apparent that most, if not all, **solid tumors build up a pro-tumorigenic inflammatory environment** that appears to be essential for tumor growth, progression, and even invasion. Emerging evidence suggests that DNA damage, leading to **premature cellular senescence**, is one source of inflammatory stress that can contribute to tumor-associated inflammation. Although the induction of premature cellular senescence is considered to be one of the cell-intrinsic mechanisms for suppressing the development of cancer (see Figure 16.3), there is also evidence that such cells express a battery of cytokines and chemokines, the so-called **senescence-associated secretory phenotype (SASP)** that may represent a wound-healing program. When combined with further mutations, such as loss of p53, SASP-associated factors may help to create an inflammatory environment within the tumor that can lead to the recruitment of macrophages and neutrophils (see Figure 16.11).

DNA damage can also lead to the direct production of inflammatory factors (without recourse to the production of senescent cells), due, at least in part, to the activation of the NFκB transcription factor via a mechanism that is still poorly understood (see Figure 16.11). NFκB is a master transcriptional regulator and is commonly activated downstream of many cytokines such as TNF, IL-1, and IL-18. NFκB activation can lead to the expression of literally dozens of other cytokines, chemokines, and growth factors, many of which have mitogenic effects on the tumor and also promote angiogenesis. Thus, direct DNA damage-associated NFκB activation may be capable of switching on a wound-healing program that becomes protracted in transformed cells. NFκB activation can also upregulate the expression of anti-apoptotic gene products, such as members of the Bcl-2 family, making the tumor more resilient to the oxygen and nutrient deprivation that frequently occur in the tumor environment.

Cell death within the tumor environment, as a result of the tumor outgrowing its blood and nutrient supply, can lead to the release of DAMPs (such as IL-1 family members). In turn, DAMPs can trigger the release of cytokines and chemokines by cells of the tumor itself, or cells within the tumor stroma, that lead to the recruitment of further macrophages and neutrophils into the tumor bed (see Figure 16.11). Recent evidence also suggests that certain DAMPs, such as IL-18 and IL-33, can also evoke a tissue repair program in Tregs, quite independent from their immunosuppressive role, which leads to the production of the EGF family member amphiregulin by these cells.

Finally, and as will be discussed more fully in the following section, certain **oncogenic mutations** that produce constitutively active forms of proteins involved in growth factor signal transduction cascades (such as Ras, Raf, MyD88) can also directly lead to the production of cytokines and chemokines that promote macrophage and neutrophil recruitment into the tumor.

Thus, there is a diversity of ways in which nascent tumors can foster an inflammatory environment, leading to the recruitment of TAMs and other innate immune cells, such as neutrophils, dendritic cells, mast cells, and a unique type of innate immune cell that has been dubbed the “myeloid-derived suppressor cell.”

Certain oncogenic mutations can drive the production of proinflammatory cytokines and chemokines to recruit innate immune cells

As noted above, certain oncogenic mutations that create constitutively active signal transduction proteins can directly lead to the production of inflammatory cytokines. A substantial proportion of tumors carry mutations in Ras or its downstream target B-Raf that render these proteins constitutively active. Constitutively active Ras or B-Raf lead to activation of the MEK and ERK kinases downstream, which has the effect of activating a battery of transcription factors that can promote cell division. Among the targets of these transcription factors are the genes for IL-6 and IL-8 and, as a consequence, tumors

carrying gain-of-function mutations in Ras and B-Raf frequently express these cytokines. If such an event were detrimental to the tumor, one would expect that clonal variants would emerge where the expression of IL-6 and IL-8 was silenced. However, it appears instead that secretion of such cytokines can enhance tumor growth in a number of ways, as we have already alluded to earlier. One possibility is that IL-6 could have autocrine growth and survival-promoting effects on the tumor itself, acting to enhance cell division or lead to the expression of anti-apoptotic proteins (Figure 16.13). Another is that IL-6 acts in a paracrine fashion on surrounding stromal cells to promote angiogenesis, thereby enhancing blood supply to the tumor. Indeed, evidence for the latter scenario has been found in mouse models where growth of chemical-induced skin tumors was impaired in *IL-6* knockout mice and this was related to the effects of IL-6 on nearby endothelial cells, rather than on the tumor itself. Use of *IL-6* knockout mice has also provided clear evidence that these animals are resistant to the development of malignant myeloma, a malignancy affecting the B-cell lineage. Furthermore, certain IL-6 promoter polymorphisms, which result in the production of higher levels of this cytokine, have been found to correlate with a poorer prognosis in breast cancer.

Similarly, tumor-derived IL-8 has been found to promote infiltration of tumors by neutrophils and macrophages that, as discussed earlier, can promote tumor growth through the production of other proinflammatory cytokines such as IL-1 and TNF as well as by secreting matrix metalloproteases that can remodel the extracellular matrix and promote tumor spread (Figure 16.13). Activity of inflammatory cells also leads to increased recruitment of endothelial cells and promoted angio-

genesis. Use of neutralizing anti-IL-8 antibodies in Ras-induced tumor models led to a marked reduction in tumor growth.

Although the fact that tumors can deliberately recruit cells of the innate immune system by secreting chemokines and proinflammatory cytokines is pretty ominous, it does suggest that one way of attacking such tumors may be through neutralizing such factors with appropriate monoclonal antibodies. Such antibodies are now available and have been approved for use in conditions such as psoriasis.

Tumor-associated macrophages are frequently polarized towards an anti-inflammatory phenotype

There is now extensive evidence to suggest that in the majority of solid tumors, with the exception of colorectal cancers, tumor-associated macrophages (TAMs) are frequently elicited and repurposed by the tumor to provide an anti-inflammatory immunosuppressive environment that can antagonize T-cell-mediated immune responses that do arise (Figure 16.12). As we discussed in Chapter 8, activated macrophages display a great diversity of transcriptional responses, depending on the tissue environment and the nature of the activating stimulus they are exposed to. **Two major macrophage populations have been identified in recent years**, termed *M1* (or *classically activated* macrophages) and *M2* (or *alternatively activated* macrophages), although this terminology is almost certainly a gross oversimplification because macrophages display functional plasticity that is more akin to a complex color palette rather than a binary scheme. However, broadly speaking, M1 macrophages are produced in response to IFN γ

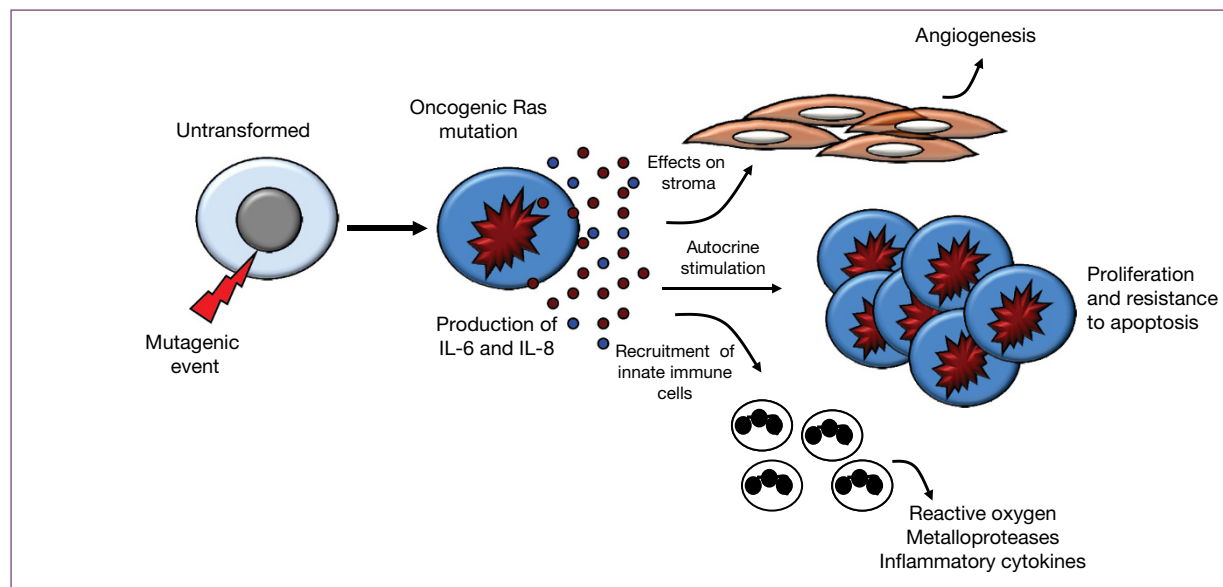


Figure 16.13 Activating Ras mutations within the tumor can lead to proinflammatory cytokine/chemokine production. Oncogenic Ras and B-Raf mutations may lead to the production of proinflammatory cytokines, such as IL-6 and IL-8, that can have diverse pro-survival and growth-promoting effects on tumors as shown.

or microbial PAMPs and express high levels of proinflammatory cytokines (e.g., TNF, IL-1, IL-6, IL-12, IL-23) as well as high surface expression of MHC class II molecules. In contrast, M2 macrophages can be induced through exposure to IL-4, IL-10, and IL-13, and these macrophages typically express low levels of MHC class II and IL-12 but increased levels of IL-10 and arginase. Most TAMs are considered to be of the M2 anti-inflammatory type, but here it must be noted that TAMs frequently produce IL-6, IL-1, and TNF, which are typically considered M1 cytokines. Because this is an area of intensive research, it is hard to make generalizations at present, but the take-home message is that **TAMs are typically polarized towards a phenotype that treats the tumor as a wound that requires healing** rather than an infection that requires elimination.

Factors that appear to be important for the recruitment of TAMs to the tumor include CSF-1, CCL2, as well as IL-1 family DAMPs that attract macrophages through binding to their cognate receptors. Indeed, targeting of CSF-1 and CCL2 or their cognate receptors through the use of neutralizing antibodies has produced promising results in mouse models of cancer and this approach is now in early stage clinical trials for cancer therapy. TAMs can directly protect the tumor from influx of immune cells through provision of anti-inflammatory cytokines, such as IL-10, or T-cell inhibitory ligands such as PD-L1 or B7-H4, both of which can suppress the development of effective T-cell responses. Macrophage-derived IL-10 can also suppress production of IL-12 by DCs, providing another means of frustrating the production of CTLs (Figure 16.12). Finally, as noted earlier in this chapter, TAMs have also been implicated in creating nutrient-depleted conditions that can

block proliferation of T-cells. Metabolism of L-arginine (via arginase-1) or production of IDO, which leads to tryptophan depletion, have both been implicated in protecting tumors from the attentions of effective CTL responses.

In situations where tumors maintain an inflammatory environment for their own ends, it is possible to attack such tumors using neutralizing antibodies against the cytokines/chemokines (or their receptors) responsible for macrophage recruitment (CSF-1, CCL2), or the particular cytokines driving tumor growth (e.g., IL-6) or those responsible for maintaining an adequate blood supply (VEGF-A). In addition, existing anti-inflammatory drugs can also have utility in these situations.

An inflammatory environment can also foster further mutation

Inflammatory cells, especially activated macrophages and neutrophils, can cause DNA damage through the production of reactive oxygen and nitrogen species and thus generate mutations that can lead to cellular transformation (Figure 16.13 and 16.14). Should this occur on an occasional basis, it is tolerable and can be viewed as one of the downsides of having a robust immune system. Moreover, cells with DNA damage can be dealt with through DNA repair, elimination via apoptosis, or one of the other cell-intrinsic mechanisms of tumor suppression, as we discussed earlier in this chapter (see Figure 16.3). However, if an inflammatory response is allowed to smolder for months or years on end, as happens in chronic colitis and viral hepatitis, for example, the inflammatory response can greatly increase the risk of malignant transformation through the generation of genetic instability at the

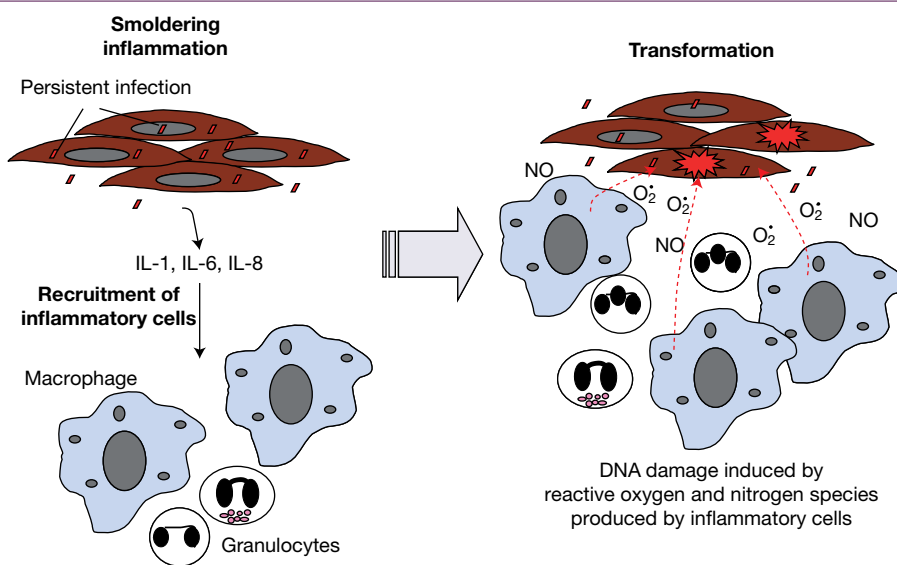


Figure 16.14 Chronic inflammation can promote malignant transformation or tumor progression. Persistent, smoldering inflammation can lead to genetic instability through recruitment of macrophages and other innate immune cells that are capable of provoking DNA damage through the production of reactive oxygen and nitrogen species. Persistent DNA damage can result in the generation of mutations that can lead to cellular transformation or that can make transformed cells even more aggressive.

site of inflammation. At present it is not really clear whether reactive oxygen and nitrogen species generated by innate immune cells trigger DNA damage directly, or whether this occurs indirectly via depletion of cytoplasmic nucleotide pools through oxidation, leading to indirect DNA damage via misincorporation of nucleotides during DNA replication (Figure 16.14). Alternatively, cytokines produced by neutrophils and macrophages (e.g., TNF) may generate DNA damage through the production of intracellular reactive oxygen species within cells of the tumor.

Irrespective of the precise mechanism of DNA damage that is instigated through smoldering inflammation, there is now little doubt that an inflammatory response can both initiate tumor formation as well as exacerbate the development of established tumors. As an example of this, tissue specimens from individuals with hepatocellular cancer frequently exhibit infiltration of the tumor by neutrophils, and a similar phenomenon is seen in mouse models of this disease (Figure 16.15). Remarkably, depletion of neutrophils in the latter models, using anti-neutrophil antibodies, drastically impairs the progression of this type of cancer (Figure 16.15). As noted earlier, this presents opportunities for attacking tumors through neutralizing some of the factors (such as IL-6 or CSF-1) that tumors rely upon to create an inflammatory environment and to recruit neutrophils and macrophages to the tumor stroma. An alternative approach would be to neutralize the factors secreted by innate immune cells (e.g., VEGF, TNF) that are

recruited into the tumor bed. Let us now return to the topic of tumor antigens and consider some of the common sources of neoepitopes that arise during the development of cancer.

Tumor antigens

For effective immune surveillance to operate, cancer cells must display some new discriminating structure that can be recognized by the immune system; such molecules are frequently referred to as *tumor antigens*.

For the immune system to mount an effective antitumor response, at a minimum, the tumor must make its presence known by expressing molecules that are not normally found within the body, or conversely, by failing to express a molecule that is normally present on healthy cells (Figure 16.16). A good example of the latter is the class I MHC molecules that are displayed on the surface of almost all nucleated cells; failure to express MHC molecules is one of the criteria used by NK cells to select target cells for attack, and as a result NK cells may play an important role in immune surveillance. The ideal tumor antigen would be expressed by cells of the tumor, but not by normal cells, and would be required for tumor growth or maintenance, thereby preventing the tumor from losing expression of this antigen through immune-driven selection. It might also be acceptable to target antigens that are highly expressed by the tumor but are also expressed by a restricted range of normal nontransformed cells, depending on whether the

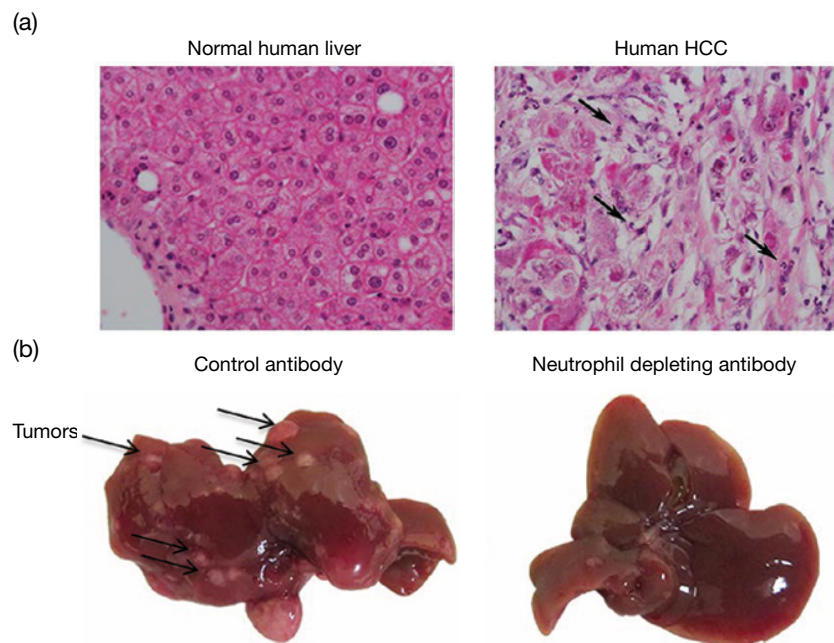


Figure 16.15 Depletion of neutrophils can blunt tumor progression. (a) Tissue section from normal human liver (left panel) versus an individual with human hepatocellular carcinoma (right panel) exhibiting extensive neutrophil infiltration (arrows). (b) In a mouse model of hepatocellular carcinoma, anti-neutrophil antibodies (right panel) can considerably delay the appearance of tumors. (Source: Derek Mann. Reproduced with permission.)

potential damage to normal tissue can be kept within an acceptable range. However, few of the tumor antigens identified to date fit this ideal profile; for the most part tumor proteins represent nonmutated proteins or other molecules that are aberrantly expressed by the tumor. Other tumor antigens represent mutant forms of proteins that appear because of

the *genomic instability* that contributed to the formation of the tumor in the first instance. As discussed earlier, many of the latter antigens will arise as a result of passenger mutations and, as a consequence, will be specific to the tumor of a particular individual and will not be shared between individuals, thereby making it difficult to select candidate antigens that are likely to have widespread utility.

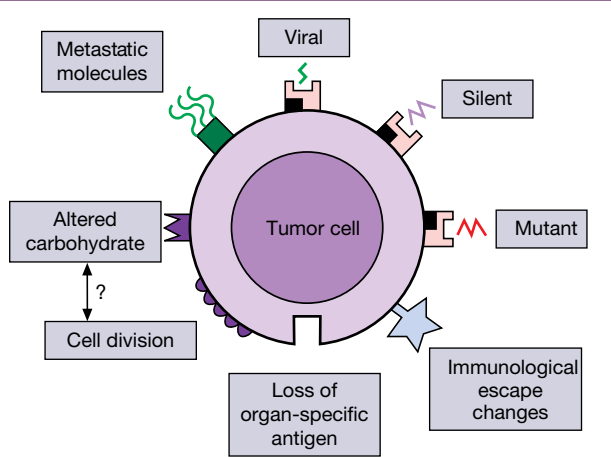


Figure 16.16 Tumor-associated surface changes.

Identification of tumor antigens

Notwithstanding the problems of immunoediting and tumor heterogeneity outlined earlier, a number of strategies have been used to identify tumor antigens. Early approaches involved immunizing mice with tumor cells to generate panels of monoclonal antibodies that were subsequently tested for their ability to discriminate between untransformed and transformed cells from the same cell lineage. This type of approach has had limited success in identifying *bona fide* tumor antigens, but has frequently led to the identification of cell surface molecules that are overexpressed or posttranslationally modified on particular tumor cell types.

A classic example is the *human epidermal growth factor receptor-2 (HER2)*, which is amplified in 15–20% of breast cancers and confers increased aggressiveness on such tumors (Figure 16.17). HER2 (also called Neu) was originally

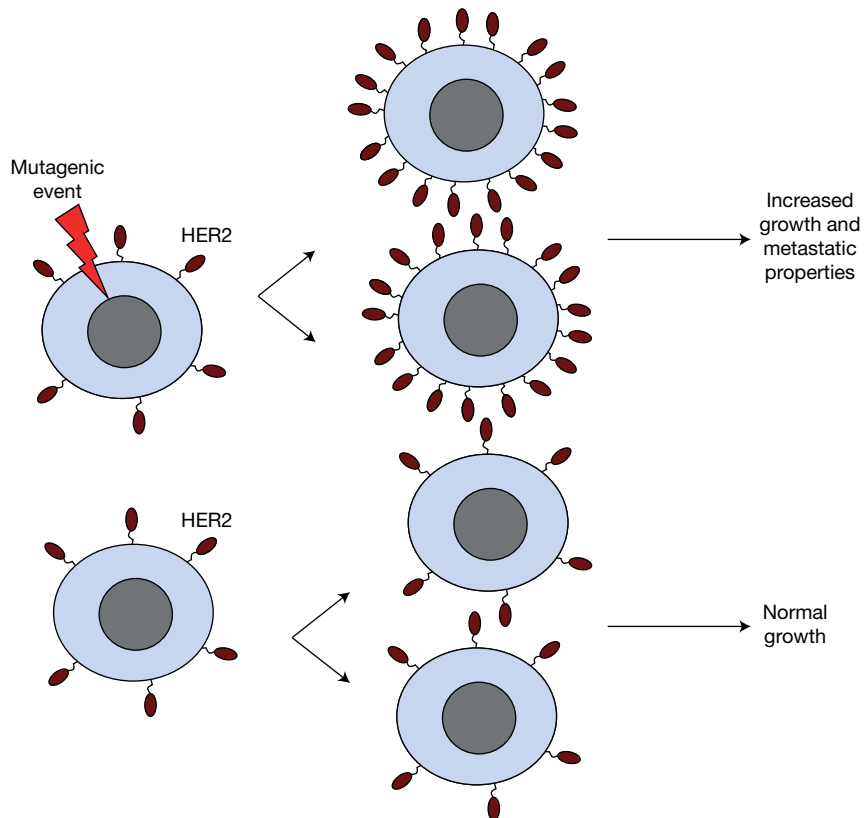


Figure 16.17 Amplification of the HER2/Neu oncogene can lead to increased proliferation and progression to malignancy.

discovered by Robert Weinberg and colleagues using genetic screening techniques to search for transforming oncogenes. Transfection of cDNA derived from a chemically transformed cell line resulted in the identification of the HER2/Neu oncogene, which is related to the epidermal growth factor receptor (EGFR). HER2 was subsequently discovered to be amplified in a subset of breast cancers and to be important for the maintenance of such tumors, as ablation of HER2 expression led to cessation of proliferation followed by apoptosis. Antibodies targeting this receptor are effective in the treatment of the subset of breast cancers that overexpress HER2, particularly if used in combination with standard chemotherapeutic drugs such as doxorubicin and paclitaxel. The observation that certain tumors express abnormal amounts of certain cell surface molecules has proved to be very useful as several of these molecules have formed the basis of monoclonal antibody-based therapies that are effective against several types of cancer.

In a similar vein to the use of antibodies as probes, single-chain Fv phage libraries have also been used to probe tumor cell surfaces for the presence of differentially expressed antigens as well as tumor-specific antigens, with some success.

Another approach involves isolating tumor-reactive T-cells from peripheral blood or tumor tissue of cancer patients and using these cells to screen autologous target cells transfected with genes from a tumor-derived cDNA library (Figure 16.18). Expansion of T-cells in response to cells transfected with a particular cDNA identifies the protein encoded by this cDNA as a candidate tumor antigen. An alternative approach uses peptides eluted from tumor-derived MHC molecules to pulse APCs to test for their ability to elicit responses from tumor-reactive lymphocytes. Peptides eliciting positive responses in such assays can be subsequently identified by purification and sequencing; this is not exactly a technically simple approach but it is feasible nonetheless.

Yet another strategy, *serological analysis of recombinant cDNA expression libraries (SEREX)*, uses diluted antiserum from cancer patients to screen for antibodies that react against proteins expressed by cDNA libraries generated from cancer tissue (Figure 16.19). This approach is predicated upon the assumption that antitumor antibodies are indicative of T-helper cells specific for such antigens. More than 1500 immunogenic proteins, which are all candidate tumor antigens, have been isolated using this method.

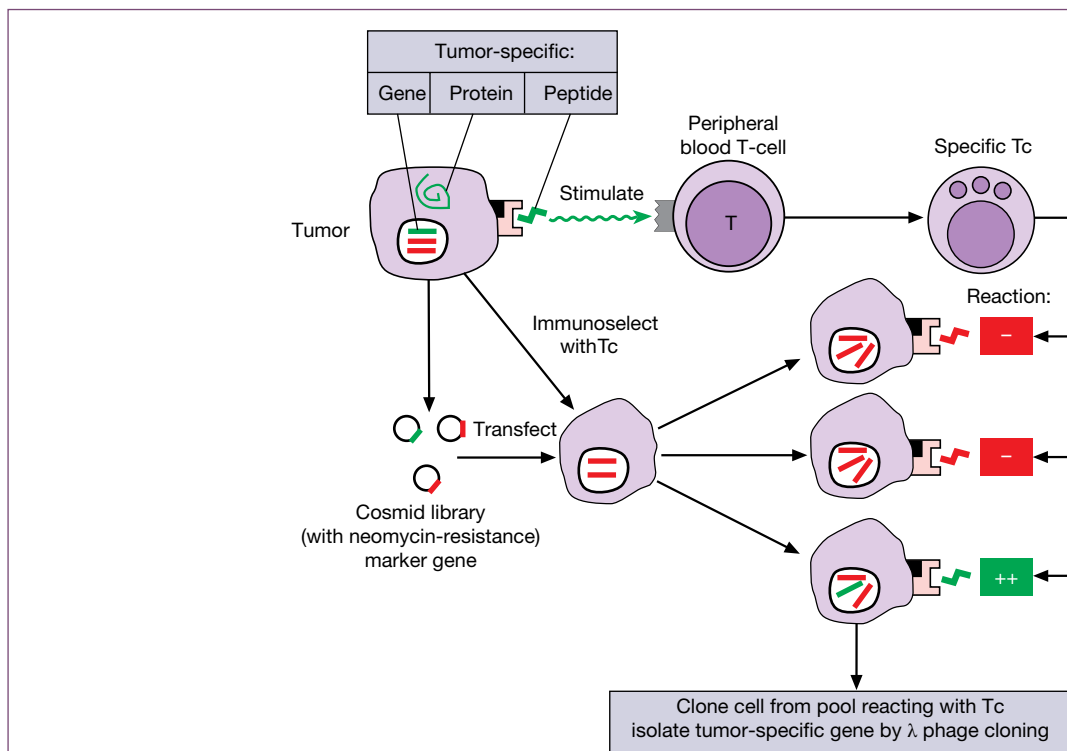


Figure 16.18 Identification of a tumor-specific gene using tumor-specific cytotoxic T-cell (Tc) clones derived from mixed tumor-lymphocyte culture. A cosmid library incorporating the tumor DNA is transfected into an antigen-negative cell line derived from the wild-type tumor by immunoselection with the Tc. Small pools of transfected cells are tested against the Tc. A positive pool is cloned by limiting dilution and the tumor-specific gene (*MAGE-1*) cloned from the antigen-positive well(s). The original *MAGE-1* belongs to a family of 12 genes. Further melanoma-specific genes, including *MART-1*, *gp100*, and *tyrosinase*, have been discovered. (Adapted from van der Bruggen P. *et al.* (1991) *Science* **254**, 1643. Reproduced with permission of AAAS.)

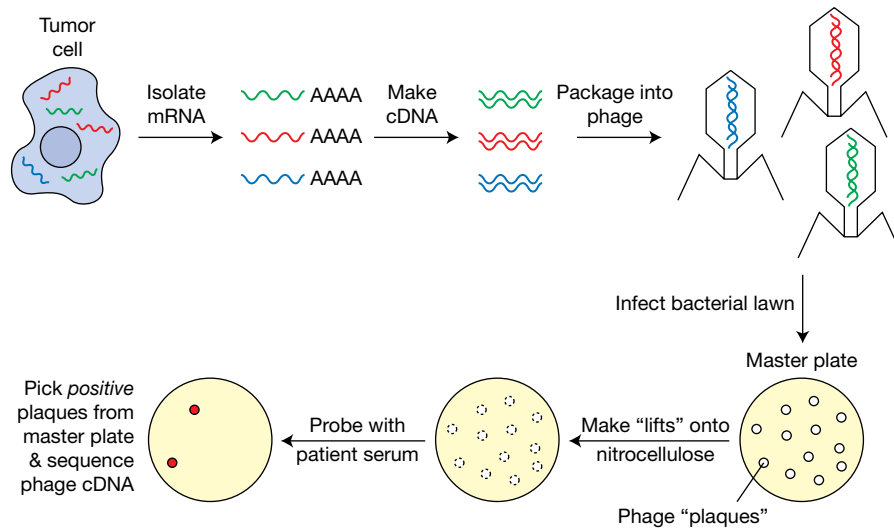


Figure 16.19 Identification of tumor antigens by serological identification of antigens expressed by recombinant cloning (SEREX). In the SEREX method, mRNA isolated from tumor biopsies is used to construct cDNA expression libraries that are then packaged into bacteriophage. A bacterial lawn is then infected with the phage library under conditions that permit expression of the tumor-derived proteins. Replica "lifts" of the bacterial lawn are made using nitrocellulose membranes and these are then probed with diluted antisera from the cancer patient. Bacterial colonies expressing tumor-derived proteins that are detected by antibodies within the patient serum can then be identified by isolating the phage from the relevant colony and sequencing the cDNA harbored within this phage.

Deep sequencing initiatives, such as the 1000 Cancer Genomes Project or *The Cancer Genome Atlas*, which is an initiative of the National Institutes of Health, have created a comprehensive catalog of somatic tumor mutations identified using deep sequencing. These resources, together with evolving bioinformatic techniques that predict MHC-binding affinity for HLA alleles expressed in the matching patients, aim to map the landscape of potentially immunogenic mutations in solid tumors. A whole raft of new tumor antigens have been identified through such approaches, but it is too early yet to say whether useful antigens will emerge that are shared among sufficient numbers of patients to provide the basis for therapeutic vaccination strategies. It is also important to note that *in vitro* or *in silico* recognition assays may not select ideal or valid tumor antigens; validation of candidate tumor antigens is clearly essential, as proteins found to be immunogenic *in vitro* may exhibit little potency *in vivo*. What is clear from such studies is that there is no shortage of neopeptides produced by tumors, but finding commonly produced neopeptides that have real therapeutic potential is still a major problem. However, what is not in dispute is that tumor antigens do indeed exist and some examples will now be discussed.

Classes of tumor antigens

To generate a tumor antigen, molecules need to be expressed that were not present in the body previously (such as a protein associated with a tumor virus), or that were expressed prior to selection of the T-cell repertoire (such as a fetal antigen), or that have become elevated in their expression to the point that

these break tolerance. Indeed, all of these mechanisms have been found to generate tumor antigens. Tumor antigens fall into several different categories, depending on their origin:

- The expression products of oncogenic viruses
- Molecules normally only expressed during fetal development
- Molecules normally expressed in specific tissues
- Mutations in proteins that arise during oncogenesis.

Let us now take a look at some specific examples.

Virally encoded antigens

As alluded to earlier, a substantial minority of tumors (~10–15%) arise through infection with **oncogenic viruses**, Epstein–Barr virus (EBV) in lymphomas, human T-cell leukemia virus-1 (HTLV-1) in leukemia, human papillomavirus (HPV) in cervical cancers, hepatitis B (HBV) and C (HCV) viruses in hepatocellular carcinoma, and Kaposi's sarcoma-associated herpesvirus (KSHV). Some of these viruses contain genes homologous with **cellular oncogenes**, which encode factors that can override the normal controls that regulate cell division and cell death (apoptosis). Expression of these genes therefore can lead to malignant transformation. However, some other viruses, such as HBV, can greatly increase the relative risk of developing cancer by as much as 100-fold, in a manner that appears to be unrelated to direct mutagenic effects of the virus but rather because of the chronic inflammation provoked by the virus. As we discussed earlier, persistent inflammation can frequently promote rather than suppress tumor development. Thus, protracted inflammatory responses can act as a driver of malignant transformation and – where inflammation occurs after a tumor has already



Milestone 16.1 Tumors can induce immune responses

The first convincing evidence for tumor-associated antigens came from the work of Richmond Prehn and Joan Main who demonstrated quite clearly that **chemically induced cancers** can induce immune responses to themselves but not to other tumors produced by the same carcinogen (Figure M16.1.1a). Tumors induced by **oncogenic viruses** are different in that processed viral peptides are present on the surface of all neoplastic cells bearing the viral genome so that Tc cells raised to one tumor will cross-react with all others produced by the same virus (Figure M16.1.1b).

Dramatic advances were made by Thierry Boon and colleagues. First, they showed that random mutagenesis of transplantable tumors (i.e., tumors that can be passaged

within a pure mouse strain without provoking rejection) can give rise to mutant progeny with strong transplantation antigens. As a result they could not be grown in syngeneic animals with a normal immune system; accordingly they were referred to as **tum-variants**. Boon's team developed a powerful technology (see Figure 16.18) that enabled them to use Tc clones specific for the tum-variant to screen cosmid clones for the mutant gene. These two breakthroughs, the recognition that mutation in tumors can generate strong transplantation reactions and the development of the technique for identifying the relevant antigens with Tc cells, heralded really profound developments in tumor immunology and put it firmly on the map as a key area for cancer research.

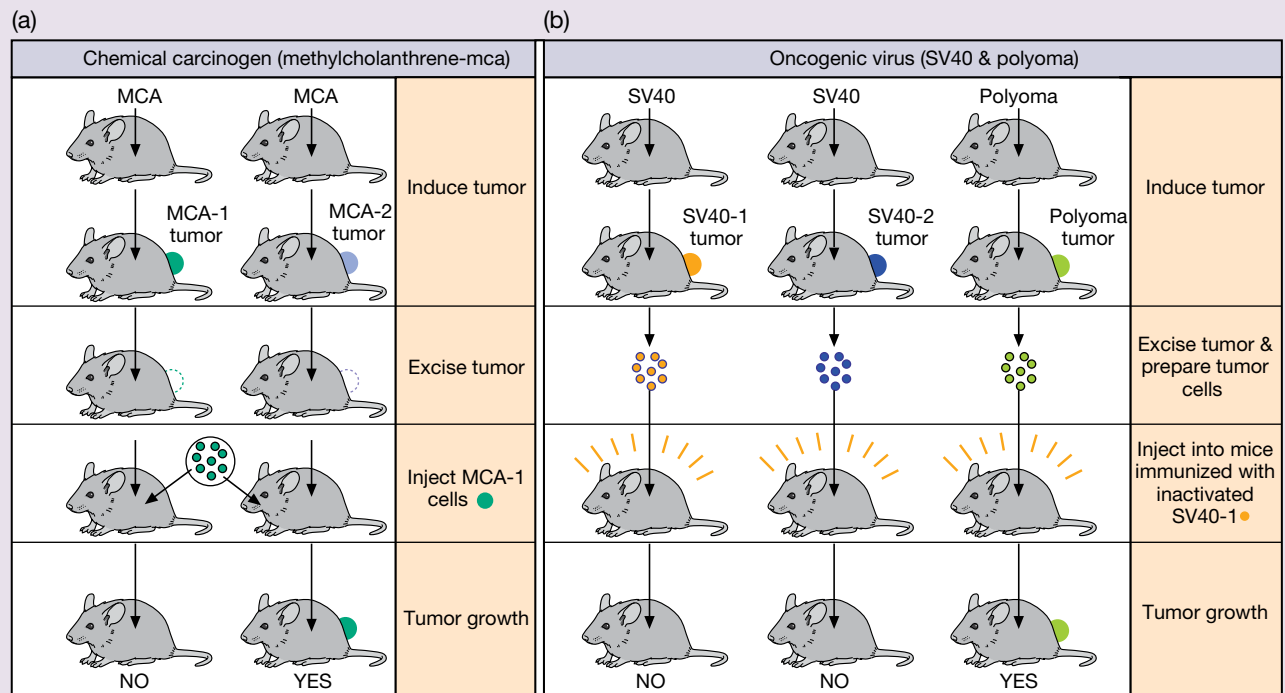


Figure M16.1.1 The specificity of immunity induced by tumors. (a) A chemically induced tumor MCA-1 can induce resistance to an implant of itself but not to a tumor produced in a syngeneic mouse by the same carcinogen. Thus each tumor has an individual antigen, now thought to be a processed mutant endogenous protein complexed with a heat-shock protein. More recent data suggest that if immunized animals are challenged with much lower numbers of tumor cells, a greater degree of cross-protection between tumors may be observed, which has been ascribed to a 44 kDa oncofetal antigen, possibly an immature version of a laminin receptor protein. (b) Tumors produced by a given oncogenic virus immunize against tumors produced in syngeneic mice by the same but not other viruses. Thus tumors produced by an oncogenic virus share a common antigen.

become established – can also nurture tumor growth through the production of inflammatory cytokines.

Virus-derived peptides associated with MHC on the surface of the tumor cell behave as powerful transplantation antigens that generate haplotype-specific cytotoxic T-cells (Tc). All tumors induced by a given virus should carry the same surface antigen,

irrespective of their cellular origin, so that immunization with any one of these tumors would confer resistance to subsequent challenge with the others, provided that there were no artifactual mutations by the virus (Milestone 16.1). Unfortunately, viruses are not innately friendly. However, the recent development of an effective vaccine that is highly protective against HPV infection

and associated cancer (predominantly cervical cancer in women), as well as genital warts, is a good illustration of the fact that the immune system can be harnessed to ward off at least some malignancies.

Expression of normally silent genes

The dysregulated uncontrolled cell division of the cancer cell creates a milieu in which the products of normally silent genes may be expressed. Sometimes these encode differentiation antigens normally associated with an earlier developmental stage. Thus tumors derived from the same cell type are often found to express such **oncofetal antigens** that are also present on embryonic cells. Examples would be α -fetoprotein in hepatic carcinoma and carcinoembryonic antigen (CEA) in cancer of the intestine. Certain monoclonal antibodies also react with tumors of neural crest origin and fetal melanocytes. Another monoclonal antibody defines the SSEA-1 antigen found on a variety of human tumors and early mouse embryos but absent from adult cells with the exception of human granulocytes and monocytes.

But the exciting quantum leap forward stems from the original observation that cytosolic viral nucleoprotein could provide a target for Tc cells by appearing on the cell surface as a processed peptide associated with MHC class I. This established the general principle that the intracellular proteins that are not destined to be positioned in the surface plasma membrane can still signal their presence to T-cells in the outer world by the processed peptide–MHC mechanism. Cytotoxic T-cells specific for tumor cells, obtained from mixed cultures of peripheral blood cells with tumor, can be used to establish the identity of the antigen employing the strategy described in Figure 16.18. By something of a *tour de force*, a gene encoding a melanoma antigen, MAGE-1, was identified. It belongs to a family of 12 genes, 6 of which are expressed in a significant proportion of melanomas as well as head and neck tumors, non-small cell lung cancers, and bladder carcinomas. MAGE-1 is not expressed in normal tissues except for germline cells in testis and gives rise to antigenic T-cell epitopes that, in the light of the absence of class I MHC on the testis cells, must be considered tumor specific. This exciting research reveals the tumor-specific antigen as an expression of a normally silent gene.

Mutations that arise during cellular transformation

The seminal work on tum-mutants (Milestone 16.1) has persuaded us that single-point mutations in oncogenes can account for the large diversity of antigens found on carcinogen-induced tumors. There is also considerable evidence for the production of mutated peptides in human tumors. The gene encoding tumor suppressor protein p53 is a well-known hotspot for mutation in numerous cancers. The mutant forms of p53 that are frequently found in tumors represent loss-of-function or dominant-interfering (i.e., the function of which opposes the normal wild-type form of this protein by competing for the same DNA binding sites but failing to

activate transcription) mutants that fail to mount the appropriate response in cells that have suffered DNA damage; such damage would normally trigger cell cycle arrest or apoptosis of the afflicted cell. Another example is represented by human oncogenic *RAS*, which is commonly mutated to generate gain-of-function proteins that differ from their normal counterparts by point mutations that generate single amino acid substitutions in positions 12, 13, or 61. Such mutations generate constitutively active forms of Ras that promote increased rates of cell division through activation of the MAPK pathway, and have been recorded in 40% of human colorectal cancers and in more than 90% of pancreatic carcinomas, as well as other malignancies. Mutated Ras peptides can induce proliferative T-cell lines *in vitro*.

In addition to these commonly found mutations, there is little doubt that hundreds of mutations, many of which generate neoepitopes, are generated during the progression of most tumors. However, the vast majority of these mutations will be private to the individual tumor (or even to certain subpopulations of cells within the same tumor), rather than shared among all individuals with the same type of cancer.

Changes in carbohydrate structure

The chaotic internal control of metabolism within neoplastic cells often leads to the presentation of abnormal carbohydrate structures on the cell surface. Sometimes one sees blocked synthesis (e.g., deletion of blood group A). In other cases there may be enhanced synthesis of structures absent in progenitor cells: thus some gastrointestinal cancers express the Lewis Le^a antigen in individuals who are Le(a⁻,b⁻) and others produce extended chains bearing dimeric Le^a or Le(a,b).

Abnormal mucin synthesis can have immunological consequences. Consider the mucins of pancreatic and breast tissue. These consist of a polypeptide core of 20-amino-acid tandem repeats with truly abundant O-linked carbohydrate chains. A monoclonal antibody SM-3 directed to the core polypeptide reacts poorly with normal tissue where the epitope is masked by glycosylation, but well with breast and pancreatic carcinomas possessing shorter and fewer O-linked chains. Tc cells specific for tumor mucins are not MHC restricted and the slightly heretical suggestion has been made that the T-cell receptors are binding multivalently to closely spaced SM-3 epitopes on unprocessed mucins; alternatively, and closer to the party line, recognition is by $\gamma\delta$ cells.

Molecules related to metastatic potential

Changes in surface carbohydrates can have a dramatic effect on malignancy. For example, colonic cancers expressing sialyl-Le^x have a poor prognosis and higher propensity to metastasize. Lung cancer patients whose tumors showed deletion of blood group A had a much worse prognosis than those with continuous A; the finding that patients expressing H/Le^y/Le^b also had a poorer prognosis than antigen-negative subjects is consistent with this observation.

The role of **CD44** (HERMES/Pgp-1) in cell trafficking, based on its interaction with vascular endothelium, has afforded it some prominence in the facilitation of metastatic spread. CD44 occurs in several isoforms with a varying number of exons between the transmembrane and common N-terminus. Normal epithelium expresses the CD44H isoform with hyaluran-binding domains, but lacking the intervening v1–v10 exons; expression of certain of these exons on tumors is indicative of a growth advantage, as they are present with higher frequency on more advanced cancers. Stable transfection of a nonmetastatic tumor with a CD44 cDNA clone encompassing exons v6 and v7 induced the ability to form metastatic tumors – a most striking effect. Further, injection of a monoclonal anti-CD44 v6 prevented the formation of lymph node metastases. Exons v6 and v10 have now been shown to bind blood group H and chondroitin 4-sulfate, respectively, and the latest hypothesis is that these carbohydrates can bind to CD44H on endothelium and thence homotypically to each other, so generating a metastatic nidus.

Changes have quite frequently been observed in the expression of class I MHC molecules. For example, oncogenic transformation of cells infected with adenovirus 12 is associated with highly reduced class I as a consequence of very low levels of TAP-1 and TAP-2 mRNA. Mutation frequently leads to diminished or absent class I expression, linked in most cases to increased metastatic potential, presumably reflecting decreased vulnerability to T-cells but not NK cells. In breast cancer, for example, around 60% of metastatic tumors lack class I.

Approaches to cancer immunotherapy

Although immune surveillance seems to operate only against strongly immunogenic tumors, the identification of a range of tumor antigens is a positive step forward (Table 16.1), and has set the stage for exploring how these antigens may be exploited to harness the patient's own immune system in the fight against cancer. On one point all are agreed: if immunotherapy is to succeed, it is essential that the tumor load should first be reduced by surgery, irradiation, or chemotherapy, as not only is it unreasonable to expect the immune system to cope with a large tumor mass, but considerable amounts of antigen released by shedding would tend to prevent the generation of any significant response in some cases because of the stimulation of regulatory T-cells. This leaves the small secondary deposits as the proper target for immunotherapy.

So what type of immune response is required for tumor destruction? Studies in mouse models, as well as cancer patients, over the past decade or so suggest that a number of criteria need to be fulfilled in order to obtain killing of tumor cells in sufficient numbers to positively impact on the course of disease. First, sufficient numbers of T-cells with highly avid recognition of tumor antigens must be generated. Then, these cells must be able to traffic to the site of the tumor and invade the stroma (supporting cells) associated with the tumor. Finally, these lymphocytes should become activated at the site of the

tumor and be capable of engaging the tumor with cytotoxic granules or cytotoxic factors such as FasL or TRAIL. Experience to date suggests that fulfilling all of these criteria poses an immense challenge and that immunotherapy alone is rarely able to offer any “magic bullet” cures. More realistically, immunological manipulations, in tandem with conventional chemo- and radiotherapy, are likely to be the way forward.

As we shall see, there has been considerable progress on many fronts in our efforts to harness the power of the immune system to eradicate tumors. One approach that has now reached the clinic is the antibody-based manipulation of immune checkpoint proteins, such as CTLA-4 and PD-1, that normally serve to downregulate T-cell responses, as discussed earlier in this chapter. Antibody-based blocking strategies against these molecules have begun to deliver the kind of antitumor responses that immunologists have long hoped were possible and several checkpoint blockade therapeutics have recently been approved for clinical use. Passive immunotherapy using monoclonal antibodies against tumor-associated cell surface molecules, such as HER2 or CD20, is also another highly successful approach that is now commonplace in clinical practice. In addition, monoclonal antibodies (mAbs) directed against VEGF-A are also currently used to treat a range of cancers. However, many additional strategies have also been attempted, or are still in development, and several of these have also shown signs of promise in preclinical mouse models. Immunotherapy-based approaches for the treatment of cancer fall into a number of distinct categories, as follows:

- Passive immunotherapy with monoclonal antibodies
- Unmasking of latent T-cell responses by targeting immune checkpoint molecules
- Antigen-independent cytokine therapy
- Vaccination approaches to stimulate immune responses against tumor antigens or the tumor vasculature
- Adoptive transfer of *ex vivo* expanded T-, NK, or DCs
- Adoptive transfer of *ex vivo* generated chimeric antigen receptor (CAR) T-cells.

Of all of these approaches, passive immunotherapy using humanized mAbs against molecules that are upregulated on certain tumors (such as HER2, EGFR, or CD20) as well as antibodies directed against molecules that suppress T-cell responses against tumors (e.g., CTLA-4, PD-1, PD-L1) have emerged as the most successful immunotherapeutics to date. Indeed, over a dozen distinct mAbs have now received regulatory approval and are used in clinical treatment of a range of cancers. However, other approaches have also showed significant promise in preclinical models. We will now look at each of these approaches in detail.

Passive immunotherapy with monoclonal antibodies

After many false dawns, mAbs have finally delivered on their early promise and the most promising results from immunotherapeutic approaches to cancer treatment have

Table 16.1 Potential tumor antigens for immunotherapy.

Antigen	Malignancy
Tumor specific	
Immunoglobulin V-region	B-cell non-Hodgkin's lymphoma, multiple myeloma
TCR V-region	T-cell non-Hodgkin's lymphoma
Mutant p21/ras	Pancreatic, colon, lung cancer
Mutant p53	Colorectal, lung, bladder, head and neck cancer
Developmental	
p210/bcr-abl fusion product	Chronic myelogenous leukemia, acute lymphoblastic leukemia
MART-1/Melan A	Melanoma
MAGE-1, MAGE-3	Melanoma, colorectal, lung, gastric cancer
GAGE family	Melanoma
Telomerase	Various
Viral	
Human papillomavirus	Cervical, penile cancer
Epstein–Barr virus	Burkitt's lymphoma, nasopharyngeal carcinoma, post-transplant lymphoproliferative disorders
Tissue specific	
Tyrosinase	Melanoma
gp100	Melanoma
Prostatic acid phosphatase	Prostate cancer
Prostate-specific antigen	Prostate cancer
Prostate-specific membrane antigen	Prostate cancer
Thyroglobulin	Thyroid cancer
α -Fetoprotein	Liver cancer
Overexpressed	
HER2	Breast, lung cancer
Carcinoembryonic antigen	Colorectal, lung, breast cancer
Muc-1	Colorectal, pancreatic, ovarian, lung cancer

Source: Fong L. and Engleman E.G. (2000) *Annual Review of Immunology* 18, 245. Reproduced with permission of Annual Reviews.

been achieved with humanized mAbs. Early attempts to use mouse mAbs for therapeutic purposes were severely hampered by strong immune responses against the foreign sequences within the mouse antibody, the so-called human anti-mouse antibody (HAMA) response. Furthermore, mouse antibodies frequently failed to activate desirable cytotoxic actions against the tumor, such as complement activation and ADCC. These early difficulties have now been overcome with the result that numerous “humanized” mAbs have now entered clinical trials and a number of mAbs targeting cell surface receptors have been approved for therapeutic use in cancer (Table 16.2).

Antibody-based targeting of cell surface tumor markers

Earlier in this chapter we discussed the example of HER2 (human epidermal growth factor receptor-2; also called Neu or erb-B2), a member of the epidermal growth factor receptor family, and its overexpression in a subset of breast cancers (Figure 16.17). This discovery led to the development of monoclonal antibodies targeting HER2 (Herceptin), which proved to be effective against tumors overexpressing this antigen, leading to the approval of Herceptin® for cancer therapy in 1998. Following on from this success, antibodies directed

Table 16.2 Selected mAbs approved or in late-stage clinical trials for cancer therapy.

Target antigen	Format	Indication	Status
HER2/neu	Unconjugated	Breast, gastric cancer	Approved for therapeutic use
CD20	Unconjugated	Chronic lymphocytic leukemia	Approved for therapeutic use
CD20	⁹⁰ Y- and ¹³¹ I-conjugates	Low-grade or follicular B-cell non-Hodgkin's lymphoma	Approved for therapeutic use
EGFR	Unconjugated	Colorectal cancer and head/neck cancer	Approved for therapeutic use
VEGR	Unconjugated	Colorectal, lung, glioblastoma, kidney cancer	Approved for therapeutic use
CD52	Unconjugated	Chronic lymphocytic leukemia	Approved for therapeutic use
MHC class II	Unconjugated	Non-Hodgkin's lymphoma	Late-stage clinical trials
CTLA-4	Unconjugated	Melanoma, non-small cell lung, renal cell carcinoma, ovarian cancer	Approved for therapeutic use
PD-1	Unconjugated	Melanoma	Approved for therapeutic use
PD-L1	Unconjugated	Melanoma	Late-stage clinical trials

Data source: Sliwkowski M.X. and Mellman I. (2013) *Science* **341**, 1192–1198.

against a variety of other cell surface molecules, such as CD20, CD52, EGF receptor, and VEGF have been approved for therapeutic use and a raft of others are currently in the clinical pipeline. Thus, it is very likely that we will see the introduction of numerous additional monoclonal antibodies to clinical practice in the coming years, either as standalone therapeutic agents, or as adjuncts to conventional chemotherapy.

HER2-directed antibodies appear to work through disrupting growth-promoting signals propagated via this EGF family receptor. Although HER2 does not appear to bind to EGF directly (a ligand for this receptor has yet to be identified), it is capable of forming heterodimers with other members of the same receptor family that do bind EGF. Thus, antibodies targeting the HER2 receptor presumably interfere with EGF-dependent growth factor signaling, as well as spontaneous HER2 signals that are generated as a result of its elevated surface expression, thereby provoking growth arrest rather than death of HER2-positive tumors. However, through use of mice lacking Fc γ receptors, a major role for ADCC responses mediated by NK cells has also been implicated in the mode of action of Herceptin.

In general, antibodies reacting with antigens on the surface of tumor cells can also protect the host by complement-mediated opsonization and lysis (modified by host complement regulatory proteins) and through recruitment of macrophage and NK ADCC function by engagement of Fc γ RIII receptors, although for macrophages this is partially countered by inhibitory Fc γ RII signals. These FcR-bearing cells serve not only as cytotoxic effectors but also as multivalent surfaces that hyper-cross-link antibody-coated target cells so providing, in many cases, a transmembrane signal that leads to apoptosis or premature exit from the cell cycle. This effect appears to sensitize neoplastic cells to irradiation and DNA-damaging chemotherapy and

holds out the exciting prospect of novel synergistic treatments whose efficacy may be enhanced by the increased immunogenicity of the dying cells.

Therapeutic immunoconjugates

Although antibody alone is effective, exciting developments have also been made in the area of immunoconjugates, particularly with respect to solid tumors. Therapeutic immunoconjugates consist of a tumor-targeting antibody linked with a toxic effector component, which can either be a radioisotope, a toxin, or a small drug molecule. Initial attempts to treat tumors with such immunoconjugates proved disappointing, mainly because the cytotoxic payloads conjugated to the mAbs were conventional chemotherapeutic drugs (such as doxorubicin) that are not sufficiently toxic when delivered in small doses. Dosimetry studies using *radioimmunoconjugates* indicate that very modest amounts, between 0.01% and 0.001% of the administered antibody per gram of solid tumor, actually reach the tumor site. So, if the initial dose delivered to the patient is 10 micromolar, which would be a pretty high dose of most cytotoxic compounds, and less than 0.01% of this dose is actually delivered to the tumor, this effectively means that the effector drug or toxin has to work in the picomolar range. The nature of the problem can be grasped when one considers that many conventional chemotherapeutics are effective in the micromolar or high nanomolar range.

This limitation prompted a search for much more toxic molecules to act as conjugates. Protein toxins such as pseudomonas exotoxin and diphtheria toxin are highly toxic *in vitro* and display activity in animal models, but they also proved to be highly immunogenic in humans and rapidly induce neutralizing antibody responses that limit their efficacy and the ability

to administer repeated doses: a problem known as the human antitoxin antibody (HATA) response. In some cases, practically 100% of patients developed HATA responses by their second treatment with a toxin immunoconjugate. Quite apart from HATA, another disadvantage of *immunotoxin conjugates* is a syndrome that appears to result from nonspecific toxin-induced damage to endothelium, called *vascular leak syndrome*, which also reduces the maximum tolerated doses of such conjugates that can be used. However, where patients are severely immunosuppressed, in the case of hematologic malignancies for example, immunotoxin conjugates are of benefit; very impressive complete remission rates approaching 70% have been recorded for patients with hairy cell leukemia using an anti-CD22–*Pseudomonas* toxin conjugate.

Another approach that has been pursued for several years now aims to exploit the cytotoxic properties of radionuclides, such as iodine-131 and yttrium-90, to irradiate the tumor in a highly precise manner. Several clinical trials have been conducted with such radioimmunoconjugates, and although there have been some notable successes, ⁹⁰Y- and ¹³¹I-labeled anti-CD20 conjugates for non-Hodgkin's lymphoma for example, the results have been generally disappointing. It has proved difficult to achieve therapeutic efficacy with many radioimmunoconjugates without exceeding the *maximum tolerated dose*, and side-effects such as myeloablation are frequently seen. Attempts have been made to reduce these nonspecific toxic effects by using α particle emitters, such as astatine-211, that have much shorter path lengths than β -emitters that reduces collateral damage to other cells. Such manipulations have the desired effect, with up to 1000-fold higher absorbed dose ratios in target organs with α -emitters relative to their β -emitter counterparts. But every silver lining has a cloud, or so it seems; the α particle radioimmunoconjugates have half-lives ranging from 60 minutes to a few hours or so, making them impractical for routine clinical use.

The search for toxic molecules in the high picomolar range eventually paid off with the discovery of inhibitors of tubulin polymerization (e.g., auristatin) and molecules that cause DNA double-stranded breaks (e.g., calicheamicin and esperamicin). One very attractive feature of these agents is that conjugation of the drug to the antibody frequently converts it into a *pro-drug* that requires removal from the antibody to regain activity. Because the linker between drug and antibody is stable in the blood, the conjugate exhibits virtually no toxicity until it becomes bound and internalized by an antigen-positive target cell. Many such *drug immunoconjugates* are currently in clinical trials or have been approved for a range of cancers, including: acute myeloid leukemia (anti-CD33–calicheamicin), colorectal and pancreatic cancer (anti-CanAg–DM1), small cell lung carcinoma (anti-CD56–DM1), and several other malignancies (anti-HER2/Neu–DM1). Considerable effort is also underway to develop even more potent cytotoxic compounds for the preparation of drug immunoconjugates. Because of their stability, potency, and clinical utility, small drug immunoconjugates are likely to rule the roost within a short time.

Antibody-mediated attack on the tumor blood supply

For solid tumors, the focus is upon two main targets. The first would be *minimal residual micrometastases in the bone marrow* that occur in one-third to one-half of patients with epithelial cancer after curative radical treatment of the primary lesion. The second would be the *reactive tissue evoked by the malignant process*, such as stromal fibroblasts expressing the F19 glycoprotein and newly formed blood vessels.

As we discussed earlier, tumors generally cannot grow beyond 1 mm in diameter without the support of blood vessels. The tumor promotes formation of these blood vessels by secreting angiogenic factors, such as VEGF. New blood vessels are biochemically and structurally different from normal resting blood vessels and so provide differential targets for therapeutic monoclonal antibodies, even though the cancer cells themselves in a solid tumor are less vulnerable to antibodies directed to specific antigens on their surface. Thus, receptors for VEGF and Eph, oncofetal fibronectin, matrix metalloproteases MMP-2 and MMP-9, and the pericyte markers aminopeptidase A and the NG2 proteoglycan are all highly and selectively expressed in vasculature undergoing angiogenesis. Considerable effort has been expended in the direction of angiogenesis inhibitors such as humanized monoclonal antibodies against VEGF and its main receptor VEGF-R2.

Inhibition of the production of proinflammatory cytokines in the tumor environment

Based on the observation that production of proinflammatory cytokines, as well as metabolites, by TAMs and fibroblasts can frequently be beneficial for the tumor, there may be instances in which neutralizing antibodies towards CSF-1, IL-6, TNF, VEGF, as well as other proinflammatory cytokines and chemokines (or indeed their receptors) may have beneficial effects in terms of reducing the blood supply and the stromal support network in the vicinity of the tumor (Figure 16.12). Studies in mice have shown that neutralizing antibodies against TNF, as well as NF κ B inhibitors can have protective effects in colon and breast cancer models. Such tactics may also be used to block recruitment of macrophages and other immune cells that provide supportive immunosuppressive environments for many tumors. The use of such “macrophage antagonists” is currently under preclinical evaluation. Interestingly, anti-CXCR4 therapy can “mobilize” CML and AML cells from the tissues into the blood, where they are more vulnerable to cytotoxic chemotherapy; this is due to disruption of CXCR4-based homing of CLL and AML cells to tissues. Inhibitors of kinases that transduce signals downstream of engagement of receptors for such cytokines and chemokines are also under evaluation.

Unmasking of latent T-cell responses

As mentioned earlier, tumors frequently exhibit the presence of infiltrating lymphocytes that appear anergic, suggesting that reactivation of such cells with an appropriate push in the right

direction may be possible. Indeed, one such approach, **blockade of checkpoint proteins**, has generated hugely promising results in recent years and suggests that the long-awaited breakthrough in tumor immunotherapy has finally arrived.

CTLA-4 blockade

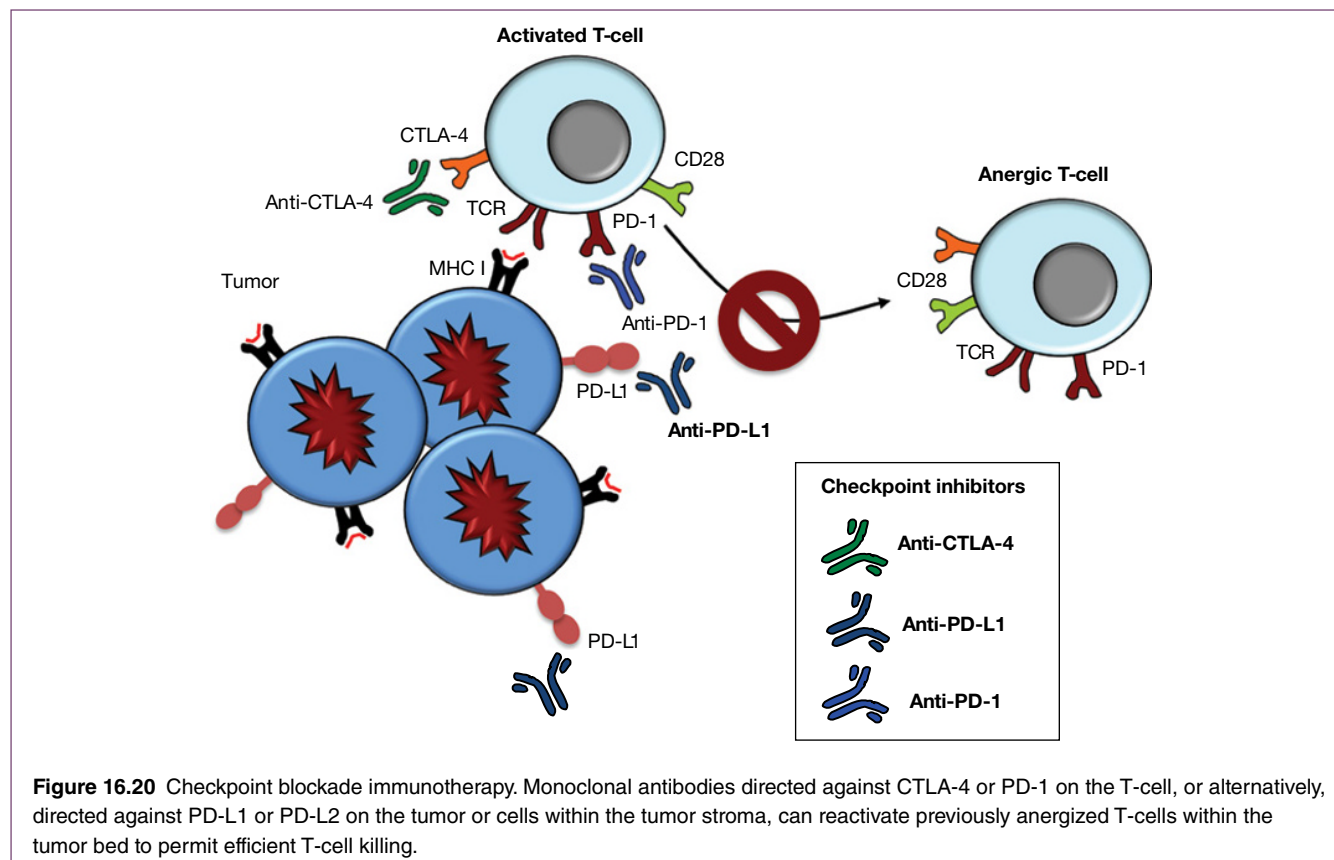
Recall from Chapter 7 that CTLA-4 can inhibit TCR co-stimulation by raising the threshold for successful TCR activation, as a result of competing for CD80/CD86 molecules on the dendritic cell. CTLA-4 is a CD28 homolog that has a higher avidity for CD80/CD86 than CD28. Whereas naive or resting T-cells do not express CTLA-4, activated T-cells upregulate this molecule on the T-cell surface, where its accumulation beyond a certain threshold enables the immune system to switch off T-cell responses (Figure 16.9). Thus, activation of T-cells not only leads to clonal expansion and the production of effectors, but also the means to terminate T-cell responses. Unfortunately, CTLA-4 can also terminate burgeoning T-cell responses to tumors. Not long after the discovery of a role for CTLA-4 in downregulating T-cell responses to tumors in the mid-1990s, it was discovered that antibodies against CD28 also blunted antitumor responses in mice. Conversely, antibodies directed against CTLA-4 greatly augmented tumor clearance in mouse models, apparently as a result of reducing the ratio of Foxp3⁺ Tregs to CD4⁺ and CD8⁺ T-cells, generating hope that

this strategy could eventually be exploited for cancer immunotherapy. A further advantage of this strategy is that, because the target (i.e., CTLA-4) is on the T-cell rather than the tumor, **this is not dependent on a specific tumor antigen** and, in principle, can be used for multiple tumor types. Thus, blockade of CTLA-4 interaction with its ligands may boost the capacity of tumor infiltrating lymphocytes to get on with the job of attacking the tumor.

As with any molecularly targeted therapy, the road from initial discovery to the clinic is long and painstaking. However, anti-CTLA-4 mAb-based therapy has shown positive benefits in a number of clinical trials with a variety of tumor types, including melanoma, renal cell carcinoma, and ovarian cancer. The first anti-CTLA-4-directed therapy received FDA approval as a treatment for melanoma in 2011, effectively creating a completely new therapeutic modality that has been termed **immune checkpoint therapy** (Figure 16.20).

PD-1 blockade

Another T-cell intrinsic immune checkpoint is also regulated by interactions between PD-1 on the T-cell and its ligands (PD-L1 and PD-L2) that are expressed on a variety of cell types, including tumors (Figure 16.20). Similar to CTLA-4, PD-1 is expressed only on activated T-cells but, unlike CTLA-4, PD-1 inhibits T-cell responses through



recruiting molecules to the TCR that damp down T-cell signaling. PD-L1 is expressed on many cell types, including epithelial cells, endothelial cells, and cells of the immune system, whereas the expression of PD-L2 is much more restricted and appears confined to APCs. mAbs directed against PD-L1 have shown considerable clinical responses in many tumor types, including melanoma, non-small cell carcinoma, renal cell carcinoma, and Hodgkin's lymphoma, and after promising phase I results against advanced melanoma, anti-PD-1 antibody therapy received FDA approval in 2014. Furthermore, combined immunotherapy with anti-CTLA-4/anti-PD-1 has also shown very promising signs in advanced melanoma, with ~50% of patients exhibiting tumor regression of 80% or greater.

Blockade of other immune checkpoint proteins

Although therapies utilizing CTLA-4 and PD-1 blocking strategies are furthest along, other immune checkpoint molecules or inhibitory molecules are currently under scrutiny. These include Lag-3, TIM-3, and VISTA. A related strategy involves inhibiting members of the c-Cbl ubiquitin ligase family that have been implicated in desensitizing the T-cell receptor to peptide–MHC stimulation. Recall from Chapter 7 that Cbl-b-deficient naive T-cells do not have a requirement for CD28-dependent co-stimulation for productive activation. This appears to be due to the role of Cbl-b in suppressing certain TCR-initiated signals under normal circumstances, thereby raising the threshold for T-cell activation. Thus, strategies aimed at selectively inhibiting Cbl-b in tumor-infiltrating T-cells may sufficiently lower their threshold for activation, such that productive immune responses now ensue without recourse to co-stimulation.

Problems associated with immune checkpoint therapy

Molecules such as CTLA-4 and PD-1 clearly have important functions in setting thresholds for T-cell activation and in reining in T-cells responses when they do occur. So there are clearly risks associated with overcoming these checkpoints, not least of which is the development of autoimmunity. Indeed, patients treated with anti-CTLA-4 antibodies can develop autoimmune colitis, dermatitis, hepatitis, and other side-effects. However, many of these conditions are much less life threatening than aggressive cancer and can be managed using immunosuppressive agents that do not greatly interfere with clearance of the tumor. Another problem can be the immunosuppressive environment of the tumor itself that can thwart the development of strong T-cell responses, despite the lifting of immune checkpoints. Thus, debulking of the tumor through surgery or through prior treatment with conventional chemo- or radiotherapy may be first required to permit the development of strong immune responses in the context of immune checkpoint therapy.

Combining checkpoint inhibition with other treatments

In addition to combining different checkpoint inhibitors, testing of which is well underway in numerous clinical trials, it is also likely that combining checkpoint inhibitors with other forms of treatment such as conventional cytotoxic chemotherapy, or molecularly targeted therapies, is also likely to yield significant therapeutic improvements. Benefits are likely to be additive, as well as possible synergistic effects through checkpoint inhibition depriving the tumor of at least some of the protection afforded by factors secreted by TAMs. Because some of these factors, such as IL-6, have cytoprotective effects (e.g., through inducing increased expression of anti-apoptotic genes), creating a more aggressive antitumor environment within the tumor is likely to deprive the tumor of some of its anti-apoptotic shielding mechanisms, thereby making it easier for conventional chemotherapeutics to kill.

Antigen-independent cytokine therapy

The first clear indication that manipulation of the immune system could be beneficial came from studies that utilized antigen-independent strategies to nonspecifically boost the immune response to the tumor. Cytokines such as IL-2, IFN, and TNF have pleiotropic effects on the immune system and some of these have shown promise in animal models as well as in clinical settings. Systemic toxicity has limited the utility of TNF, which exhibits rapid and severe hepatotoxicity in animal models and is therefore of limited use in cancer therapy.

Interleukin treatment

High doses of IL-2 have been administered to patients with metastatic melanoma or kidney cancer, and at least partial tumor regression was observed in 15–20% of patients, with some patients displaying complete regression. The beneficial effects of high doses of IL-2 may be due to stimulation of pre-existing tumor-responsive T-cells or to NK activation. On activation by IL-2 or IL-12, NK cells are capable of killing a variety of fresh tumor cells *in vitro* and, on the basis of studies on mice with mammary glands carrying the *HER2/neu* oncogene, it would not be unreasonable to conduct a trial of systematic IL-12 treatment in cancer patients with minimum residual disease in an attempt to prevent recurrence and to inhibit incipient metastases. Because of the promising results seen upon IL-2 administration, many subsequent tumor vaccine trials have been conducted in combination with this cytokine.

Interferon therapy

In trials using IFN α and IFN β , a 10–15% objective response rate was seen in patients with renal carcinoma, melanoma, and myeloma, an approximate 20% response rate among patients with Kaposi's sarcoma, about 40% positive responders in patients with various lymphomas and a remarkable response rate of 80–90% among patients with hairy cell leukemia and mycosis fungoides.

With regard to the mechanisms of the antitumor effects, in certain tumors IFNs may serve primarily as antiproliferative agents; in others, the activation of NK cells and macrophages may be important, while augmenting the expression of class I MHC molecules may make the tumors more susceptible to control by immune effector mechanisms. In some circumstances the antiviral effect could be contributory.

For diseases such as renal cell cancer and hairy cell leukemia, IFNs have induced responses in a significantly higher proportion of patients than have conventional therapies. However, in the wider setting, most investigators consider that their role will be in combination therapy (e.g., with active immunotherapy or with various chemotherapeutic agents where synergistic action has been observed in murine tumor systems). IFN α and β synergize with IFN γ and the latter synergizes with TNF. IFN α acts as a radiation sensitizer and its ability to increase the expression of estrogen receptors on cultured breast cancer cells suggests the possibility of combining IFN with anti-estrogens in this disease.

Colony-stimulating factors

Normal cell development proceeds from an immature stem cell with the capacity for unlimited self-renewal, through committed progenitors, to the final lineage-specific differentiated cells with little or no potential for self-renewal. Therapy aimed at inducing tumor cell differentiation is founded on the idea that the induction of cell maturation decreases and possibly abrogates the capacity of the malignant clone to divide. Along these lines, GM-CSF has been shown to enhance the differentiation, decrease the self-renewal capacity and suppress the leukemogenicity of murine myeloid leukemias. Recombinant human products are now undergoing trials.

It is over 100 years since the physician Coley gave his name to the mixture of microbial products termed *Coley's toxin*. This concoction certainly livens up the innate immune system and does produce remission in a minority of patients. The suggestion has been made that these beneficial effects are due to the release of TNF as the vascular endothelium of tumors is unduly susceptible to damage by this cytokine and hemorrhagic necrosis is readily induced. It is questionable whether the critical levels of TNF are reached in the human as these would be very toxic, although one study involving perfusion of an isolated limb with TNF, IFN γ , and melphalan provoked lesions in the tumor endothelium without affecting the normal vasculature. Opinion is coming round to the view that the Coley phenomenon may be linked more to boosting a pre-existing weak antitumor immunity.

Vaccination approaches

T-cell-mediated responses, rather than antibodies, are likely to be more effective at savaging solid tumors, particularly those expressing processed intracellular antigens on their surface. Moreover, as the majority of tumors are MHC class II negative,

it looks as though we are aiming at essentially CD8 cytotoxic T-cell responses, although CD4 T-cells can be involved in protective reactions against tumor-associated vasculature and are required for persistence of CD8 T-cells.

Vaccination with viral antigens

Based on the observation that certain forms of cancer (e.g., lymphoma, cervical carcinoma, hepatocellular carcinoma) are caused by oncogenic viruses, efforts are well underway to prepare suitable vaccines against these viruses. Viruses associated with cancer include Epstein–Barr virus (EBV), human papillomavirus (HPV), hepatitis B virus (HBV), hepatitis C virus (HCV), human T-cell leukemia virus-1 (HTLV-1), and Kaposi's sarcoma-associated herpesvirus (KSHV). Progress in the development of antitumor vaccines has been hampered by the poor immunogenicity of many of the vaccine candidates tested. Happily, some of these vaccines have now made it through clinical trials and we have entered the era of vaccination against several forms of cancer.

Human papillomavirus

HPV represents the poster child for a successful vaccination strategy against a virus-induced cancer and at least two different prophylactic vaccines targeting HPV have now been approved for clinical use. HPV is endemic in the human population, with ~50% of women becoming HPV-positive by 24 years of age, and is responsible for the development of the majority of cervical carcinomas in women, as well as genital, anal, and penile warts. Globally, ***cervical cancer is the second most common cause of cancer in women*** and each year almost 50% of women diagnosed with cervical cancer (~500 000 worldwide) die from it.

The search for a HPV vaccine started in the late 1980s and culminated in the approval of the first preventative HPV vaccine in 2006. An additional preventative HPV vaccine was also approved for human use a year later. These vaccines have proved to be highly effective against the development of cervical cancer in women. Both vaccines are composed of recombinant L1 protein, one of the two HPV nucleocapsid proteins derived from the commonest HPV genotypes, HPV type 16 and 18, which are responsible for almost 70% of cervical cancers. The L1 nucleocapsid protein assembles into virus-like particles, which are morphologically identical to HPV virions but are obviously noninfectious, and produces a robust neutralizing antibody response that provides protection from HPV infection via mucosal and epithelial surfaces.

HPV vaccination should ideally take place before infection has occurred, which in practice means before sexual activity has begun. Although this has not been investigated to date, it is possible that HPV vaccines may well prove to have some benefit in the early, precancerous, dysplastic stages of cervical cancer progression (i.e., after infection has occurred).

Hepatitis B virus

Worldwide, chronic hepatitis B infection is responsible for 80% of all liver cancer, a major cause of mortality. Although the first HBV vaccine became available in 1981, this vaccine was based upon inactivated pooled plasma from infected donors and was discontinued in 1990 thanks to the development of a safer, more effective, vaccine based on a recombinant subunit approach. The HBV vaccine contains a recombinant form of one of the viral envelope proteins, hepatitis B surface antigen (HBsAg). Immunization generates strong neutralizing antibodies against HBsAg and vaccination of newborns has led to a marked decrease in rates of liver cancer. Attempts to develop a vaccine against the related HCV virus have met with little success thus far, despite several clinical trials in recent years. Vaccines based upon recombinant proteins, peptides, and DNA encoding viral proteins are all at various stages of development.

Work is also in progress to develop a vaccine against EBV, which is responsible for the development of Burkitt's lymphoma as well as nasopharyngeal carcinoma, one of the most common cancers in China. The major site of EBV infection is the oropharyngeal cavity, with transmission occurring via oral contact, hence the name "kissing disease." The major EBV surface glycoprotein gp350/220 is the main target of EBV-neutralizing antibodies and several vaccine candidates based on gp350/220 have been developed although they generally need strong adjuvants to elicit decent immunity.

Immunization with whole tumor cells

A variety of approaches utilizing both autologous and allogeneic whole tumor cell preparations have been tried in an effort to awaken antitumor responses. This has the advantage that we do not necessarily have to know the identity of the antigen concerned. The disadvantage is that the majority of tumors are weakly immunogenic, and do not present antigen effectively and so cannot overcome the **barrier to activation of resting T-cells**. Remember, the surface MHC-peptide complex on its own is not enough; co-stimulation with molecules such as B7-1 and B7-2 and possibly certain cytokines is required to push the G0 T-cell into active proliferation and differentiation. Once we get to this stage, however, **the activated T-cell no longer requires the accessory co-stimulation** to react with its target, for which it has a greatly increased avidity owing to upregulation of accessory binding molecules such as CD2 and LFA-1 (Figure 16.21). Whole cell immunization approaches have been largely unsuccessful in human clinical trials, possibly because of the very limited quantity of antigenic molecules present in whole cells where the majority of proteins present are nonimmunogenic.

When proper co-stimulation is provided, encouraging results have been reported, at least in animal models. Vaccination with B7-transfected murine melanoma generated CD8⁺ cytolytic effectors that protected against subsequent tumor challenge; in other words, transfection enabled the

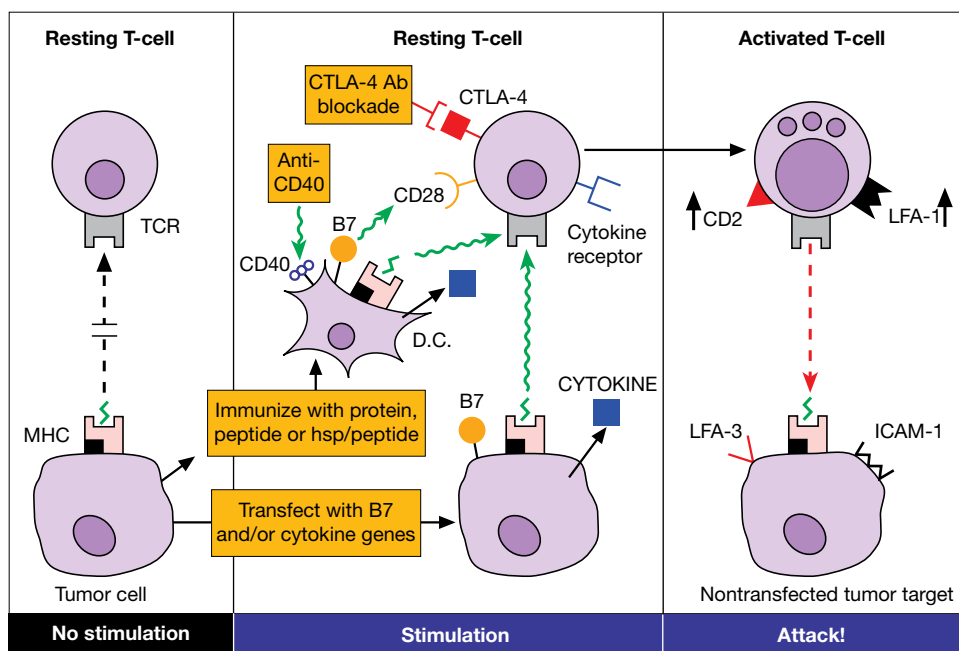


Figure 16.21 Immunotherapy by transfection with co-stimulatory molecules. The tumor can only stimulate the resting T-cell with the co-stimulatory help of B7-1 and B7-2 (CD80/CD86) and/or cytokines such as GM-CSF, IFN γ , and various interleukins (IL-2, IL-4, and IL-7). CTLA-4 blockade enhances immunogenicity. Alternatively, the T-cell can be stimulated directly by tumor antigens presented by dendritic cells (DCs) that can themselves be activated by cross-linking their surface CD40 with antibody. Once activated, the T-cell with upregulated accessory molecules can now attack the original tumor lacking co-stimulators.

melanoma cells to present their own antigens efficiently, while the untransfected cells were vulnerable targets for the cytotoxic T-cells so produced. A further telling observation was that an irradiated nonimmunogenic melanoma line that had been transfected with a retroviral vector carrying the *GM-CSF* gene stimulated potent and specific antitumor immunity, almost certainly by enhancing the differentiation and activation of host antigen-presenting cells.

A less sophisticated but more convenient approach ultimately utilizing similar mechanisms involves the administration of the irradiated melanoma cells together with BCG that, by stimulating TLR receptors and generating a plethora of inflammatory cytokines, increases the efficiency of presentation of tumor antigens derived from necrotic cells. In a large-scale study of over 1500 patients, 26% of vaccinees were alive at 5 years compared with only 6% of those treated with the best-available conventional therapy.

Vaccination against neovascularization

Solid tumors are composed of malignant cells as well as a variety of nonmalignant cell types, collectively called stromal cells, such as endothelial cells and fibroblasts. Because solid tumors cannot grow to any appreciable size without a blood supply, tumors stimulate the production of new blood vessels by secreting angiogenic factors, such as VEGF, that stimulate endothelial cell proliferation. Because growing tumors are highly reliant on their blood supply, attacking the tumor vasculature by targeting antigens selectively expressed on these blood vessels may deprive the tumor of oxygen and nutrients, provoking regression one would hope. VEGF, one of a family of angiogenic factors, exerts its effects through interaction with its cognate receptor, VEGF-R2 (also known as KDR in humans and Flk-1 in the mouse), which provides signals that promote proliferation, survival, and motility of endothelial cells. Antibodies directed against VEGF-R2, or indeed VEGF itself, can block tumor angiogenesis in murine tumor models but translation into the clinic has been hampered owing to problems relating to delivery of sufficient amounts of these agents to fully block VEGF-R2 activity. An alternative strategy involves *breaking immune tolerance* to VEGF-R2-positive endothelial cells by pulsing *in vitro* generated dendritic cells with soluble VEGF-R2 followed by transferring these cells back into the animal. A major advantage of this approach is that the tumor endothelium, unlike the tumor itself, is genetically stable as it represents nontransformed tissue, and this makes it unlikely that mutant cells will arise that have lost VEGF-R2 expression. This strategy has been reported to generate VEGF-R2-specific neutralizing antibody as well as cytotoxic T-cells capable of effectively destroying endothelial cells.

Therapy with subunit vaccines

The variety of potential tumor antigens thus far identified (see Table 16.1) has spawned a considerable investment in clinical therapeutic trials using peptides as vaccines. Because of

the pioneering work in characterizing melanoma-specific antigens, this tumor has been the focus of numerous studies that exploit to the full the academic background to modern immunology. Encouraging results in terms of clinical benefit, linked to the generation of cytolytic T-cells (CTLs), have been obtained following vaccination with peptides complexed with heat-shock proteins or modified at class I anchor residues to improve MHC binding. Such peptides have been delivered either alone, using recombinant viruses (fowlpox, adenovirus, vaccinia), or as naked DNA, along with adjuvant. The inclusion of accessory factors, such as IL-2 or GM-CSF, and ***CTLA-4 blockade*** can be crucial for success. Potentially tolerogenic peptide vaccines can be converted into strong primers for CTL responses by triggering CD40 with a cross-linking antibody that can substitute for T-cell help in the direct activation of CTLs (Figure 16.22). Anti-CD40 treatment alone was also shown to partially protect mice bearing ***CD40-negative*** lymphoma cells, an effect attributed to the activation of endogenous dendritic APCs (see Figure 16.21). However, although some promising indications of immune responses to tumors have been recorded using such approaches, evaluation of multiple vaccine-based clinical trials involving 440 patients, mainly with melanoma, produced an objective response rate of only 2.6%. This disappointingly poor statistic is rather sobering and suggests that we still have some way to go before optimism is warranted.

It would be premature to write-off vaccination approaches at this stage, however, as it should be borne in mind that all of the clinical trials that have been carried out using such vaccines have been conducted in patients with advanced disease.

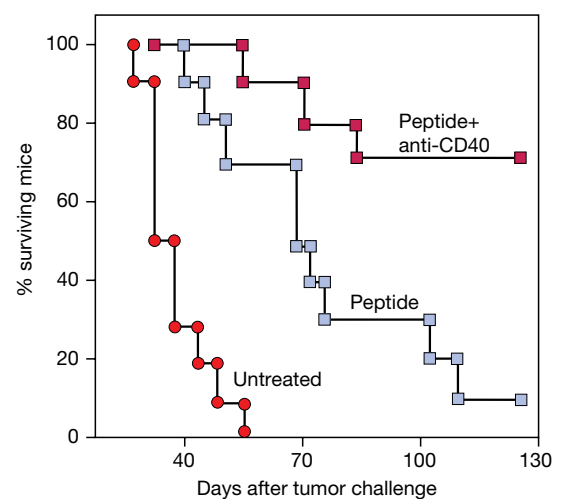


Figure 16.22 CD40 ligation enhances the protective effect of a peptide vaccine against a pre-existing tumor. Six days after injection of human papillomavirus-16 (HPV16)-transformed syngeneic cells, mice were immunized with the HPV16-E7 peptide in incomplete Freund's adjuvant with or without an anti-CD40 monoclonal, or left untreated. (Data source: Diehl L. *et al.* (1999) *Nature Medicine* 5, 774.)

Moreover, all standard therapies have, more often than not, also failed in such individuals. Vaccination with tumor antigens may prove to be more successful where early diagnosis has occurred, or where a genetic predisposition towards a familial form of cancer exists, as a preventative measure against tumor development.

Ex vivo expanded lymphocytes or dendritic cells

Adoptive T-cell transfer

Adoptive cell transfer (ACT) with large numbers of *ex vivo* expanded T-cells may overcome some of the barriers to effective therapy seen with conventional vaccination approaches (Figure 16.23). It may even be possible to genetically engineer the adoptively transferred cells to constitutively express cytokines such as IL-2 or GM-CSF to boost their activity. An alternative approach, which will be discussed in more detail below, is the introduction of an artificial T-cell receptor to enable the reinfused T-cell to recognize a tumor antigen directly, without recourse to MHC-based antigen presentation by the tumor. As unlikely as the latter approach may seem, T-cells displaying chimeric antigen receptors (CAR T-cells) have showed significant promise in multiple clinical trials.

Returning to conventional Tc cells, the generation of cytotoxic T-cell effectors *ex vivo* has the potential to uncover responses that are not evident in an environment where tumor-derived inhibitory factors, or T-regulatory cells, may be present. The typical approach involves isolating T-cells from patients and these are then expanded *in vitro* in the presence of high concentrations of IL-2 (Figure 16.23). To maximize the chances of expanding rare tumor-reactive T-cell precursors, mature dendritic cells expressing co-stimulatory signals along with a source of tumor antigen are now in common use. Over a period of 2–3 weeks 1000-fold expansion of T-cells can be achieved. These *in vitro* expanded CD8 T-cells are then transferred back to the patient (up to 10^{11} cells per individual!) but can rapidly disappear if the tumor burden is high. Administration of IL-2 *in vivo* or co-transfer of CD4 T-cells can improve CD8 T-cell survival; **the presence of CD4 T-cells appears to be crucial for persistence of CD8 T-cells** and optimal cytotoxic effector function. The failure of vaccination approaches using predominantly class I-based peptides may be due to the lack of CD4 T-cell expansion and this should be perhaps borne in mind for future studies. ACT of *in vitro* expanded lymphocytes into lympho-depleted hosts can result in up to **75% of circulating T-cells with antitumor activity**, way beyond the levels seen with peptide vaccines.

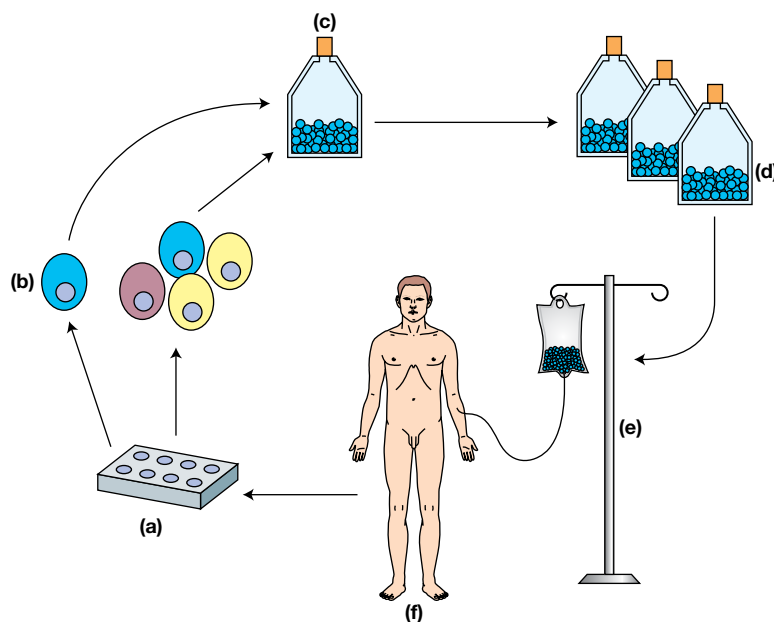


Figure 16.23 Improving the efficacy of adoptive cell transfer-based immunotherapy. A variety of strategies are being employed to enhance the efficacy of adoptive therapy using *ex vivo* expanded T-cells. (a) Tumor-reactive T-cells (dark blue) from the patient are stimulated *in vitro* with antigen-presenting cells (APCs). To enhance stimulation of tumor-reactive T-cells APCs can be transfected with genes encoding tumor antigens. (b) Selection of tumor-reactive T-cell clones or lines can be enhanced using peptide–MHC tetramers or bispecific antibodies to stimulate specific T-cell precursors. (c,d) Tumor-specific cells are then expanded in IL-2 followed by (e) intravenous infusion of tumor-specific T-cells into the patient. (f) Successful persistence of the transferred T-cells may be enhanced by prior depletion of host lymphocytes and/or administration of homeostatic cytokines (IL-2, IL-15, IL-21) post infusion. (Adapted from Riddell S.R. (2004) *Journal of Experimental Medicine* 200, 1533.)

Although the numbers of individuals that have received such ACT-based therapy are still low, very impressive objective response rates of 40–50% have been reported in lympho-depleted melanoma patients, with persistence of transferred cells for up to 4 months. Clearly some risks must be borne in mind when transferring such large numbers of activated lymphocytes into a patient, not least the possibility of generating autoimmunity to tissues other than the tumor. Careful selection of tumor antigens to favor those that are not expressed, or are minimally expressed, on tissues other than the tumor is clearly essential in these situations.

There are some indications that lymphocyte-mediated tumor eradication may be simply a numbers game. Although peptide vaccination approaches can increase circulating tumor-reactive cells 5- to 10-fold, this pales in comparison with observations that up to 40% of circulating CD8 T-cells are reactive against EBV in patients with infectious mononucleosis. Early indications suggest that ACT is capable of achieving such impressive numbers of specific T-cells, especially when combined with prior lympho-depletion. The lymphopenic environment may be favorable as this may free-up space in the lymphoid compartment for the incoming T-cells and create less competition for homeostatic cytokines such as IL-7 and IL-15. Another advantage of this approach is that depletion of recipient lymphocytes can remove suppressor/regulatory T-cells that are suspected to play a significant part in damping down antitumor responses in the first place.

Chimeric antigen receptor (CAR) T-cell therapy

An exciting and highly sophisticated approach to adoptive T-cell transfer that has shown significant promise in several small clinical trials involves the introduction, *ex vivo*, of artificial **chimeric antigen receptors (CARs)** that are specific for tumor antigens or antigens highly expressed on transformed cells, into patient-derived T-cells (Figure 16.24). The repurposed autologous T-cells are then reinfused into the patient, but are now equipped with a means of **directly recognizing the tumor in a manner that is completely independent of the specificity the TCR borne by the CAR T-cell**. CARs are constructed by combining the antigen-binding site of a monoclonal antibody directed against a tumor antigen, with some of the intracellular signaling components of a T-cell receptor (e.g., CD3 ζ chain). This artificial receptor enables antigen recognition on the tumor independent of MHC restriction, while retaining the desirable antitumor properties of a T-cell (Figure 16.24). The general idea is that, upon antigen recognition by the CAR ectodomain through engagement with antigen on the tumor plasma membrane, the CAR becomes aggregated on the T-cell and leads to activation of the cytotoxic activity of the T-cell towards the tumor. To work, the CAR intracytoplasmic domain (i.e., the endodomain) needs to mimic both natural TCR stimulation, as well as co-stimulation via CD28. This is achieved through combining components from the CD28 co-receptor as well as the immunoreceptor tyrosine-based activation motifs (ITAMs) present in the cytoplasmic CD3 ζ domain of the TCR complex (Figure 16.24).

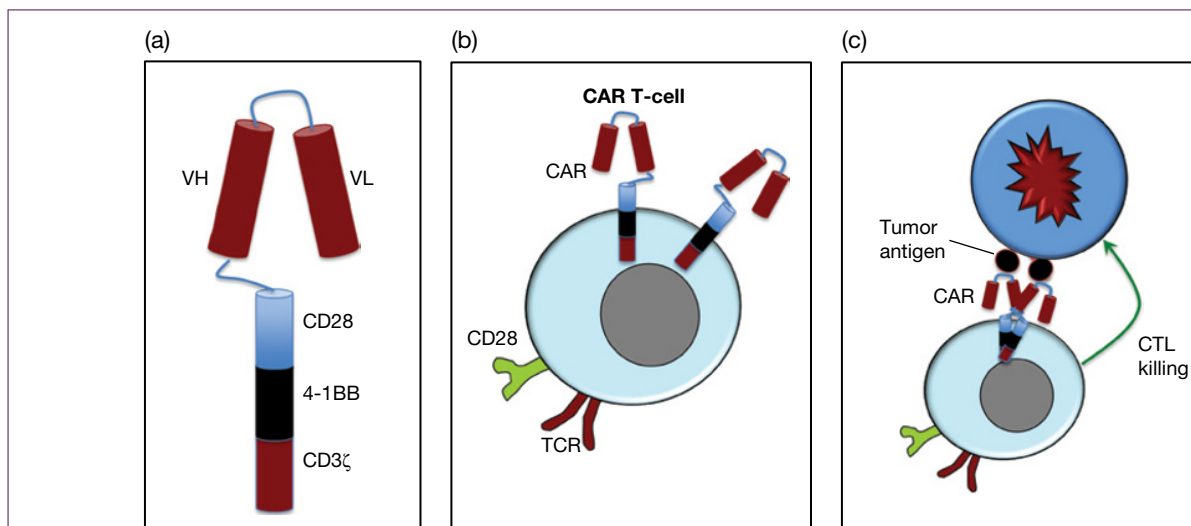


Figure 16.24 Chimeric antigen receptor (CAR) T-cells directed against tumor antigens. CAR T-cells are constructed through introduction of a plasmid encoding an artificial CAR (a), which is specific for a particular tumor antigen or an antigen highly expressed on transformed cells (such as CD20), into patient-derived T-cells (b). CAR T-cells can recognize and kill tumors in a manner independent of the T-cell receptor (TCR) specificity of the engineered T-cell (c). The cytoplasmic portion of the CAR contains elements from CD28 and the CD3 co-receptor complex that replaces the need for co-stimulation of the CAR T-cell by CD80/CD86. CTL, cytotoxic T-cell.

Although adoptive CAR T-cell therapy might seem almost too sophisticated to actually work in practice, this approach has shown sufficient promise in preclinical mouse models to carry out multiple small-scale human clinical trials using CARs targeted towards CD19, which is overexpressed in various B-cell malignancies. Indeed, results in non-Hodgkin's lymphoma have been impressive and complete remission rates of ~90% have been observed in acute lymphoblastic leukemia. CARs targeting CD20 and CD30 are also in development. One might ask why CAR T-cells are required when the simple infusion of mAbs, such as anti-CD20, have been highly successful in the treatment of lymphomas? However, CAR T-cells offer the potential of active trafficking to tumor sites, *in vivo* expansion, long-term persistence, and more complete tumor cell killing. Additionally, these therapies have the potential to be "one-shot" treatments that induce complete and sustained remission.

So what are the downsides? It must be admitted that such treatments are inherently risky. Unless the CAR T-cells are 100% specific for a tumor antigen, there is the risk of off-target effects that eliminate endogenous cell populations. Indeed, this is the reality for existing CAR T-cell therapies that target CD19 or CD20, both of which are also expressed on untransformed B-cells. However, this side-effect can be ameliorated through infusion of immunoglobulins. Replacing the function of other cell populations, such as endogenous T-cells, if CARs targeting T-cell leukemias or lymphomas are contemplated, will be more problematic. It should also be noted that any therapy that involves removing a patient's own cells, modifying them through introduction of a new gene, followed by reintroduction into the patient, inevitably leads to concerns surrounding the inadvertent generation of new mutations. The problem here is that introduction of the CAR transgene could well end up transforming the CAR T-cell population if the transgene becomes integrated near a proto-oncogene or into a tumor suppressor gene. Further limitations of the approach are that the tumor antigen has to be surface expressed, which is not the case for the vast majority of tumor antigens. More seriously, excessive cytolytic activity can lead to systemic inflammatory response syndrome (SIRS), which can be rapidly fatal, as this involves excessive TNF and/or IL-6 production due to hyperactivation of large numbers of CAR T-cells. And last but not least, generation of CAR T-cells is likely to be highly costly and needs to be tailored to the patient's own cells. It is a fact of life that health budgets are not limitless and cost-benefit analyses frequently rule out certain therapies as simply unaffordable for most.

Despite all of the above concerns, development of CAR-based therapies is moving forward and there should be further exciting developments in this area in the near future.

NK cell therapy

We have already alluded to the possible importance of NK cells in tumor surveillance and tumor killing, so it is natural to consider that *in vivo* expansion or adoptive transfer of large

numbers of activated NKs may also be of clinical benefit. NK-based therapies are somewhat lagging behind T-cell-based approaches although they are not being overlooked. Clinical trials on cancer patients have assessed the effects of daily subcutaneous administration of low-dose IL-2, following high-dose cytotoxic chemotherapy, for its effects on NK cell numbers and activation status in these individuals. Although NK cell expansion was seen, these cells did not appear to be maximally cytotoxic, perhaps because of inhibitory NK receptors finding the appropriate ligands on the tumor. More recent attempts involved using NK cells from related *haploidentical donors* to treat poor-prognosis patients with acute myeloblastic leukemia. The idea here is to achieve a partial mismatch between the donor NKs and the recipient that may provoke NK activation and greater tumor kill as a result. Expansion and persistence of the donor NK cells was observed after high-dose immunosuppression of recipients and complete remission in 5 out of 19 patients was achieved – encouraging signs indeed.

Dendritic cell therapy

The sheer power of the *dendritic cell (DC)* for the initiation of T-cell responses has been the focus of an ever-burgeoning series of immunotherapeutic strategies that have elicited tumor-specific protective immune responses via injection of isolated DC loaded with tumor lysates or tumor antigens or peptides derived from them. Considerable success has been achieved in animal models and increasingly with human patients (Figure 16.25). The copious numbers of DCs needed for each patient's individual therapy are obtained by expansion of CD34-positive precursors in bone marrow by culture with GM-CSF, IL-4, and TNF, and sometimes with extra goodies such as stem cell factor (SCF) and Fms-like tyrosine kinase 3 (Flt3)-ligand. CD14-positive monocytes from peripheral blood are easier to access, and generate DCs in the presence of GM-CSF plus IL-4; however, they need additional maturation with TNF that increases cost and the chance of bacterial contamination. Another approach is to expand the DCs *in vivo* by administration of Flt3-ligand. The circulating blood DCs increase in number 10- to 30-fold and can be harvested by leukapheresis.

Some general points may be made. First, where peptides are used to load the DC, sequences that bind strongly to a given MHC class I haplotype must be identified; sequences will vary between patients with different haplotypes and they may not include potential CD4 helper epitopes. Recombinant proteins will overcome most of these difficulties, and a mixture should be even better as it should recruit more CTLs and be more able to "ride out" any new tumor antigen mutations. However, proteins taken up by DCs are relatively inefficient at "cross-priming" CD8 CTLs through the class I processing pathway, although several tactics are being explored to circumvent this problem: they include conjugation to an HIV-tat "transporter" peptide that increases class I presentation 100-fold and transfection with RNA and recombinant vectors such as fowlpox.

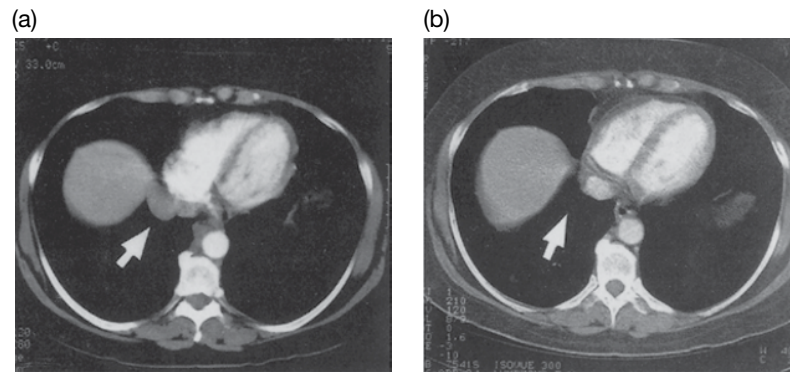


Figure 16.25 Clinical response to autologous vaccine utilizing dendritic cells pulsed with idiotype from a B-cell lymphoma. Computed tomography scans through patient's chest: (a) prevaccine and (b) 10 months after completion of three vaccine treatments. The arrow in (a) points to a paracardiac mass. All sites of disease had resolved and the patient remained in remission 24 months after beginning treatment. (Source: Hsu F.J. *et al.* (1996) *Nature Medicine* 2, 52. Reproduced with permission of Nature Publishing Group.)

Second, the procedure is cumbersome and costly but, if it becomes common, it will be streamlined and, anyway, the costs must be set against the expenses of conventional therapy and the immeasurable benefit to the patient. Third, why does the administration of small numbers of antigen-pulsed DCs induce specific T-cell responses and tumor regression in patients in whom both the antigen and DCs are already plentiful? As we discussed earlier in this chapter, DCs in or near malignant tissues are frequently immature, either because of the absence of PAMPs, or owing to production of VEGF, IL-10, or other factors by the tumor that can arrest DC maturation to generate

immature “tolerogenic” DCs. Such immature DCs may smother tumor-reactive T-cell responses at birth rather than nurture them. Tumors can also secrete chemokines to recruit CD4⁺CD25⁺Foxp3⁺ regulatory T-cells, shifting the tumor environment to a tolerogenic rather than an immunogenic one. It will certainly be interesting to see whether strategies aimed at triggering the maturation of immature DCs, or through neutralization of tumor-derived factors that polarize DCs and macrophages within the tumor environment towards an anti-inflammatory state, can initiate effective antitumor responses.

Cellular transformation

- Cancer is typically caused by genetic lesions that affect genes that promote proliferation in tandem with lesions that interfere with the elimination of cells through apoptosis.
- Cancer is not a single disease and represents a wide spectrum of conditions caused by a failure of the controls that normally govern cell proliferation, differentiation, and cell survival.
- Cellular transformation is a multistep process and involves the acquisition of a series of mutations in oncogenes and tumor suppressor genes that cooperate to achieve the fully transformed state.
- Cancer incidence varies between tissues.
- Mutagenic agents, including viruses, promote cellular transformation.

A variety of cell-intrinsic mechanisms of tumor suppression exist

- The requirement for growth factors normally prevents uncontrolled growth.

- Telomere shortening acts as a barrier to cellular transformation.
- Tumor suppressor proteins monitor cell division and can deploy a range of countermeasures upon detection of DNA damage or aberrant mitogenic signaling, including DNA repair, premature cellular senescence, or apoptosis.

There are a variety of cell-extrinsic mechanisms of tumor suppression

- CTL and NK responses are likely to be most effective in tumor killing.
- There is some evidence that antibody-mediated responses may also be effective through capturing tumor antigens and enhancing their presentation to DCs. In addition, NK cell antibody-mediated killing (ADCC) is another mechanism of harnessing the specificity of antibody responses.
- T-cells generally mount effective surveillance against tumors associated with oncogenic viruses or UV induction that are strongly immunogenic. More weakly immunogenic tumors are not controlled by T-cell surveillance, although sometimes low-grade responses are evoked.

- NK cells play a role in containing tumor growth and metastases. They can attack MHC class I-negative tumor cells because the class I molecule imparts a negative inactivation signal to NK cells.
- Tumors evolve a variety of mechanisms to escape host immune responses, confirming that the immune system exerts selective pressure on tumors.

The cancer problem from an immune perspective

- A preoccupation of the immune system with infectious agents, which carry PAMPs, has predisposed us towards largely ignoring (through T-cell tolerization or the emergence of Tregs) entities that lack these.
- Cancers employ multiple strategies to evade as well as repel immune attack.
- Transformed cells are not usually highly immunogenic and are therefore not strongly recognized by cells of the immune system. This tends to lead to tolerization of T-cell responses that do emerge. Cancers lack PAMPs and contain few nonself determinants.
- Lack of T-cell co-stimulation typically tolerizes to tumor antigens.
- Immunoediting of strong tumor antigens as cancers develop can eventually lead to immune escape and subverts the development of strong T-cell responses.
- Tumors express factors such as B7 ligands, PD-L1 and PD-L2 that engage T-cell checkpoint regulators, such as CTLA-4 and PD-1. Engagement of T-cell checkpoint regulators by cells of the tumor, or cells recruited to the tumor stroma, leads to suppression of T-cell responses to tumors.
- Solid tumors almost always actively solicit innate immune cells to create an anti-inflammatory, wound-healing environment. Inflammatory cytokines can enhance tumor growth and confer resistance to immune attack.

Inflammation can enhance tumor initiation, promotion and progression

- Solid tumors are perceived by the immune system as wounds that need to be healed, rather than attacked.
- Solid tumors almost always recruit tumor-associated macrophages (TAMs) and neutrophils through the secretion of cytokines and chemokines, such as CSF-1 and IL-8. Such cells can provide the tumor with an abundance of cytokines and growth factors that can promote angiogenesis (e.g., VEGF, IL-8), trigger tumor proliferation (e.g., IL-6, EGF, IL-8), suppress anti-tumor immune responses (e.g., IL-10, TGF β), and upregulate anti-apoptotic proteins (e.g., IL-6, IL-11).
- TAMs can also suppress the emergence of effective T-cell responses through provision of CTLA-4 and PD-1 ligands.
- Prolonged inflammation can also predispose towards the development of cancer (e.g., liver, colon). Cell death in the tumor, due to deprivation of nutrients and blood

supply, can also generate an inflammatory environment through release of DAMPs from tumors.

- Infection can enhance tumor growth and survival through harnessing NF κ B-dependent upregulation of anti-apoptotic proteins that can make tumors resistant to stress. TLR-driven NF κ B activation can also lead to the production of cytokines, such as IL-1 and IL-6, which can have autocrine growth-promoting effects.
- An inflammatory environment can foster mutation through the production of reactive oxygen and nitrogen species that can provoke DNA damage and generate mutations that drive cellular transformation.
- Certain oncogenic mutations can promote the production of proinflammatory cytokines and chemokines, thereby recruiting cells of the innate immune system that can enhance tumor proliferation, the growth of new blood vessels (angiogenesis), and tumor spread.

Tumor antigens

- Thousands of candidate tumor antigens have now been identified but most are specific to individual tumors and are not shared between individuals. Identification of shared cancer neoantigens, which can be used as vaccines, may well be an unattainable therapeutic goal for most cancers.
- Reactivation of dormant T-cell responses against patient-specific neoantigens, using inhibitors of T-cell checkpoint regulators such as CTLA-4 or PD-1, is an achievable way of exploiting cancer neoantigens therapeutically.
- Processed peptides derived from oncogenic viruses are powerful MHC-associated transplantation antigens.
- Some tumors express genes that are silent in normal tissues: sometimes they have been expressed previously in embryonic life (oncofetal antigens).
- Many tumors express weak antigens associated with point mutations in oncogenes such as *ras* and *p53*. The surface Ig on chronic lymphocytic leukemia (CLL) cells is a unique tumor-specific antigen.
- Dysregulation of tumor cells frequently causes structural abnormalities in surface carbohydrate structures.

Approaches to cancer immunotherapy

- Immunotherapy is likely to be much more effective after a tumor mass has been debulked.
- Passive immunotherapy, using mAbs targeting antigens elevated on tumor cells, such as HER2, CD20, CD52, and EGFR, is now in routine clinical use. Such antibodies work through enabling NK-mediated ADCC attack of transformed cells and/or through prevention of ligand binding to growth factor receptors.
- Monoclonal antibodies conjugated to drugs, toxins, or radiolabels can target tumor cells or antigens on new blood vessels or the reactive stromal fibroblasts associated with malignancy.

- Monoclonal antibodies targeted against negative regulators of T-cell activation (e.g., CTLA-4, PD-1, PD-L1) have shown impressive results in clinical trials against a range of cancers and have been approved for use in humans. Such checkpoint inhibitors reactivate anergic T-cells that have been tolerized against tumor antigens.
- Antibody-mediated attack on the tumor blood supply (e.g., anti-VEGF) is also successful and neutralization of cytokines involved in recruiting macrophages and neutrophils to tumors (e.g., CSF-1, CCL-2, IL-8), or in generating a pro-tumor inflammatory environment (IL-6, IL-11) are likely to prove therapeutically useful.
- Innate immune mechanisms can be harnessed. High concentrations of IL-2 can enhance responses to malignant melanoma and other tumors, systemic IL-12 may be effective against minimal residual disease. IFN γ and IFN β are very effective in the T-cell disorders, hairy cell leukemia, and mycosis fungoides, less so but still significant in Kaposi's sarcoma and various lymphomas; they may be used in synergy with other therapies. GM-CSF enhances proliferation and decreases leukemogenicity of murine myeloid leukemias.
- Cancer vaccines based on oncogenic viral proteins are effective and provide a prophylactic measure against virus-induced cancers, such as cervical cancer.
- Weakly immunogenic tumors provoke anticancer responses if given with an adjuvant, such as BCG, or if transfected with co-stimulatory molecules, such as B7 and cytokines IFN γ , IL-2, IL-4, and IL-7.
- CD8 CTLs are favored for the attack on solid tumors, and CD4 T helper cells are likely to be required for persistence and optimal effector function of CD8 T-cells.
- A variety of potential tumor antigens have been identified and intense effort is being expended in the investigation of peptides as subunit vaccines. Their immunogenicity can be enhanced by complexing with heat-shock proteins and by accessory factors such as GM-CSF, CTLA-4/PD-1 blockade, and anti-CD40 stimulation.
- Clinical trials using peptide-based vaccines have been disappointing but adoptive cell transfer-based immunotherapy using *in vitro* expanded CD8 T-cells has shown more promise.
- T-cells carrying chimeric antigen receptors (CARs) targeted against CD19 have also shown early promise in a number of clinical trials.
- Powerful immunogens have been created by pulsing dendritic antigen-presenting cells with peptides from melanoma antigens and framework regions of CLL Ig.



Now visit www.roitt.com to test yourself on this chapter.

FURTHER READING

- Ancrile B.B., O'Hayer K.M., and Counter C.M. (2008) Oncogenic *Ras*-induced expression of cytokines: a new target of anti-cancer therapeutics. *Molecular Interventions* **8**, 22–27.
- Banchereau J. and Palucka A.K. (2005) Dendritic cells as therapeutic vaccines against cancer. *Nature Reviews Immunology* **5**, 296–306.
- Brown S.D., Warren R.L., Gibb E.A., *et al.* (2014) Neo-antigens predicted by tumor genome meta-analysis correlate with increased patient survival. *Genome Research* **24**, 743–750.
- Grivennikov S.I., Greten F.R., and Karin M. (2010) Immunity, inflammation, and cancer. *Cell* **140**, 883–899.
- Kahn J.A. (2009) HPV vaccination for the prevention of cervical intraepithelial neoplasia. *New England Journal of Medicine* **361**, 271–278.
- Karin M., Lawrence T., and Nizet V. (2006) Innate immunity gone awry: linking microbial infections to chronic inflammation and cancer. *Cell* **124**, 823–835.
- Loo D.T. and Mather J.P. (2008) Antibody-based identification of cell surface antigens: targets for cancer therapy. *Current Opinion in Pharmacology* **8**, 627–631.
- Mantovani A. and Allavena P. (2015) The interaction of anticancer therapies with tumor-associated macrophages. *Journal of Experimental Medicine* **212**, 435–445.
- Melief C.J.M., van Hall T., Arens R., Ossendorp F., and van der Burg S.H. (2015) Therapeutic cancer vaccines. *Journal of Clinical Investigation* **125**, 3401–3412.
- Muranski P. and Restifo N.P. (2009) Adoptive immunotherapy of cancer using CD4⁺ T cells. *Current Opinion in Immunology* **21**, 200–208.
- Murphy A., Westwood J.A., Teng M.W., Moeller M., Darcy P.K., and Kershaw M.H. (2005) Gene modification strategies to induce tumor immunity. *Immunity* **22**, 403–414.
- Prendergast G.C., Smith C., Thomas S., *et al.* (2014) Indoleamine 2,3-dioxygenase pathways of pathogenic inflammation and immune escape in cancer. *Cancer Immunology, Immunotherapy* **63**, 721–735.
- Rabinovich G.A., Gabrilovich D., and Sotomayor E.M. (2007) Immunosuppressive strategies that are mediated by tumor cells. *Annual Review of Immunology* **25**, 267–296.
- Ramos C.A., Heslop H.E., and Brenner M.K. (2016) CAR-T cell therapy for lymphoma. *Annual Review of Medicine* **67**, 165–183.
- Reichert J.M. and Valge-Archer, V.E. (2007) Development trends for monoclonal antibody cancer therapeutics. *Nature Reviews Drug Discovery* **6**, 349–356.
- Ruffell B. and Coussens L.M. (2015) Macrophages and therapeutic resistance in cancer. *Cancer Cell* **27**, 462–472.

Sharma P. and Allison J.P. (2015) Immune checkpoint targeting in cancer therapy: toward combination strategies with curative potential. *Cell* **161**, 205–214.

Sliwkowski M.X. and Mellman I. (2013) Antibody therapeutics in cancer. *Science* **341**, 1192–1198.

Srivastava P.K. (2015) Neoepitopes of cancers: looking back, looking ahead. *Cancer Immunology Research* **3**, 969–977.

Taniguchi K. and Karin M. (2014) IL-6 and related cytokines as the critical lynchpins between inflammation and cancer. *Seminars in Immunology* **26**, 54–74.

Teng M.W., Galon J., Fridman W.H., and Smyth M.J. (2015) From mice to humans: developments in cancer immunoediting. *Journal of Clinical Investigation* **125**, 3338–3346.

CHAPTER 17

Autoimmune diseases

Key topics

- The spectrum of autoimmune disease 500
- What causes autoimmune disease? 503
- Mechanisms in autoimmune disease 507
- Pathogenic effects of autoantibody 513
- Pathogenic effects of complexes with autoantigens 516
- T-cell-mediated hypersensitivity as a pathogenic factor in autoimmune disease 519
- Some other diseases with autoimmune activity 521
- Measurement of autoantibodies 522
- Therapeutic options 522

Roitt's Essential Immunology, Thirteenth Edition. Peter J. Delves, Seamus J. Martin, Dennis R. Burton, and Ivan M. Roitt.
 © 2017 John Wiley & Sons, Ltd. Published 2017 by John Wiley & Sons, Ltd.
 Companion website: www.roitt.com

Just to recap ...

Although most immune responses are beneficial in that they recruit antibodies, complement, phagocytic cells, lymphocytes, and so forth in order to eliminate infectious pathogens, sometimes immunity is inadvertently directed against antigens that do not pose a threat. The word hypersensitivity is often used to describe such reactions. They include tissue-damaging responses to what should be innocuous environmental antigens, as seen in allergy, and the rejection of foreign tissue introduced into the body by the procedure of transplantation. It is clear that the diversity-generating mechanisms involved in recombination of the V(D)J antigen receptor genes of lymphocytes have the potential to give rise to specific recognition of almost any antigen. One downside of this flexibility is that some of the antigen receptors that are produced are able to recognize our own body components – self antigens. Usually autoreactive cells that are potentially pathogenic (e.g., those with high-affinity receptors) are either “weeded out” by the central and peripheral tolerance mechanisms, resulting in clonal deletion and clonal anergy, or restrained by regulatory T-cells.

Introduction

In all individuals there is a degree of recognition of self. Indeed, T-cells are required to be positively selected in the thymus for recognition of **self MHC**. Furthermore (except in profoundly immunodeficient individuals) self-reactive B-cells, and self peptide + self MHC reactive T-cells, are detectable in the circulation of all of us, as are **autoantibodies** (i.e., antibodies capable of reacting with self components). In people without autoimmune disease the latter are predominantly low-affinity IgM autoantibodies, often produced by CD5⁺ B-1 cells as part of the “natural” antibody spectrum. The term **autoimmune disease** is applied when **autoimmunity** results in **pathology**. Nonpathological autoimmunity may in fact assist in the removal of worn-out or damaged cells and molecules. Thus, a low level of autoimmunity seems to be the norm and generally does not result in pathology. However, if immunological tolerance fails to eliminate or control pathogenic self-reactive lymphocytes then autoimmune disease arises.

The spectrum of autoimmune disease

A substantial minority of individuals, estimated to be 5–8% of the population, do, however, develop autoimmune disease. Once they occur, most of these diseases then remain for life. Although some are relatively mild in nature, quite a few are associated with significant morbidity and mortality.

In practice it is not always clear whether a particular clinical entity is in fact an “autoimmune disease” or a disease not caused primarily by an autoimmune attack but which is, nonetheless, associated with autoimmune phenomenon (Table 17.1). We will discuss some such diseases, including psoriasis and atherosclerosis, later in this chapter. There are also a number of autoinflammatory diseases, such as the hereditary

Table 17.1 Classification criteria for autoimmune diseases. Not all these criteria will necessarily need to be fulfilled, as clearly it will often not be possible to demonstrate transfer of disease with autoreactive serum and/or autoreactive lymphocytes in humans.

Indications that a disease is autoimmune

Presence of high titer autoantibodies and/or autoreactive lymphocytes <i>in vivo</i>
Autoantibody binding and/or T-cell reactivity to autoantigen <i>in vitro</i>
Transfer of disease with autoreactive serum and/or autoreactive lymphocytes
Immunopathology consistent with autoimmune-mediated processes
Beneficial effect of immunosuppressive interventions
Exclusion of other possible causes of disease
MHC association
Animal model mirroring the human disease

periodic fever syndromes, characterized by an **absence** of high-titer autoantibodies or autoantigen-specific T-cells. Such conditions are caused by a malfunction of innate immune system components and therefore do not depend upon the breakdown of the specific immunological tolerance, which is so closely involved in the classical autoimmune diseases.

In the conventional autoimmune diseases the tissue distribution of the **autoantigen** to a large extent determines whether the disease is “**organ-specific**” or “**non-organ-specific**.” **Hashimoto’s disease** is an example where the antigens that are recognized are pretty much restricted to a single organ, in this case the thyroid (Figure 17.1a). There is a specific lesion in this endocrine gland involving infiltration by mononuclear cells (lymphocytes, macrophages, and plasma cells), destruction of thyroid epithelial cells, and germinal center formation accompanied by the production of circulating antibodies that are specific for thyroid antigens (Milestone 17.1). In some other disorders, however, the lesion tends to be localized to a single organ even though the antibodies are non-organ-specific. A good example would be **primary biliary cirrhosis**, where the small bile ductule is the main target of inflammatory cell infiltration but the serum antibodies present – mainly mitochondrial – are not liver specific.

The non-organ-specific autoimmune diseases, as their name suggests, are systemic in nature and often have a rheumatological component. In **systemic lupus erythematosus (SLE)**, which is an excellent example, antinuclear antibodies (ANA) are present that react with the nucleus of all cell types (Figure 17.1b) and the lesions are not confined to any one organ. Pathological changes are widespread and are seen in the skin (the “lupus” butterfly rash on the face is characteristic), kidney glomeruli, joints, serous membranes, blood cells, and blood vessels.

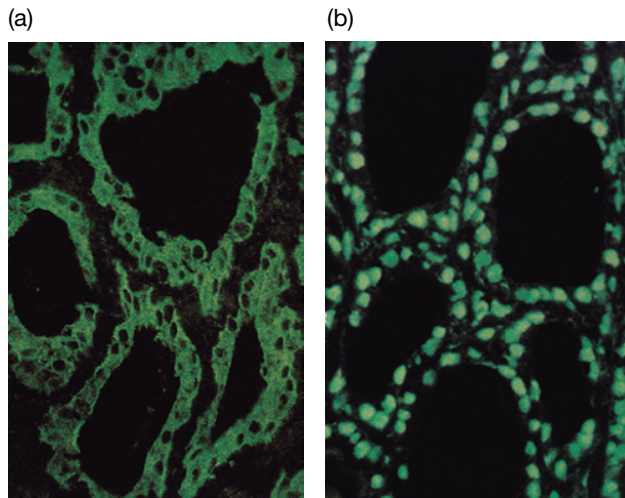


Figure 17.1 Fluorescent antibody studies in autoimmune diseases. (a) Thyroid peroxidase antibodies staining cytoplasm of thyroid epithelial cells. (b) Diffuse nuclear staining on a thyroid section obtained with nucleoprotein antibodies from a patient with systemic lupus erythematosus. (Source: G.F. Bottazzo. Reproduced with permission.)

Some of the most prevalent autoimmune diseases and their associated autoantibodies are listed in Table 17.2. Much of our understanding of autoimmune disease, and the development of new and effective therapies, have arisen from the study of animal models (Table 17.3).

Overlap of autoimmune disorders

There is a tendency for more than one autoimmune disorder to occur in the same individual and when this happens the association is often, but by no means always, between diseases within the same region of the organ-specific or non-organ-specific autoimmune spectrum. Thus patients with Hashimoto's thyroiditis have a much higher incidence of pernicious anemia than would be expected in a random population matched for age and sex (10% as against 0.15%). Conversely, both Hashimoto's thyroiditis and Graves' disease of the thyroid are diagnosed in pernicious anemia patients with an unexpectedly high frequency. Other associations are seen between Addison's disease (an autoimmune disease affecting the adrenal gland) and autoimmune thyroid disease, and so on.

Systemic autoimmune disease, such as SLE, is clinically associated with a number of other disorders including rheumatoid arthritis (RA) and Sjögren's syndrome.



Milestone 17.1 The discovery of thyroid autoimmunity

Over a century ago Sergei Melnikoff, in 1900, reported that some male animals were able to produce antibodies that recognized their own spermatozoa. However, these antibodies were not pathogenic and the view of the highly respected Paul Ehrlich that the body would not produce harmful anti-self immune responses (a situation he referred to as "horror autotoxicus") was at that time widely accepted. However, reports followed of self-immunity to erythrocytes (William Donath and Karl Landsteiner in 1904) and lens (F.F. Krusius in 1910). In the early 1930s, Thomas Rivers and his colleagues developed the experimental allergic encephalomyelitis (EAE) model and provided evidence that immune cells can attack the brain. Nonetheless, during the first half of the twentieth century there was a general air of skepticism regarding the idea that disease could arise as a result of autoimmunity. However, during the 1940s more reports of what seemed to be autoimmune pathology were published. Eventually any remaining skeptics were won over in 1956 when, remarkably, three major papers from the far corners of the globe established a link between autoimmunity and pathology in the thyroid.

Noel Rose and Ernest Witebsky in Boston (USA) immunized rabbits with rabbit thyroid extract in complete Freund's adjuvant. To what one might hazard was Witebsky's dismay and Rose's delight, this procedure resulted in the production of thyroid autoantibodies and

chronic inflammatory destruction of the thyroid gland architecture (Figure M17.1.1a,b).

Having noted the fall in serum gammaglobulin that followed removal of the goiter in Hashimoto's thyroiditis and the similarity of the histology (Figure M17.1.1c) to that of Rose and Witebsky's rabbits, Ivan Roitt, Deborah Doniach, and Peter Campbell in London (UK) tested the hypothesis that the plasma cells in the gland might be making an autoantibody to a thyroid component, so causing the tissue damage and chronic inflammatory response. Sure enough, the sera of the first patients tested had precipitating antibodies to an autoantigen in normal thyroid extracts that was soon identified as thyroglobulin (Figure M17.1.2).

Finally, in Dunedin (New Zealand), Duncan Adams and Herbert Purves were seeking a circulating factor that might be responsible for the hyperthyroidism of Graves' disease. They injected patient's serum into guinea-pigs whose thyroids had been pre-labeled with ^{131}I and followed the release of radiolabeled material from the gland with time. Whereas the natural pituitary thyroid-stimulating hormone (TSH) produced a peak in serum radioactivity some 4 hours or so after injection of the test animal, serum from Graves' disease patients had a prolonged stimulatory effect (Figure M17.1.3). The so-called **long-acting thyroid stimulator (LATS)** was ultimately shown to be an IgG mimicking TSH through its reaction with the TSH receptor but differing in its time-course of action, largely because of its longer half-life in the circulation.

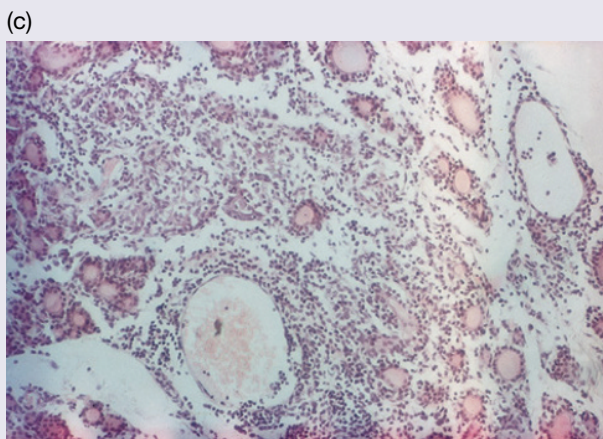
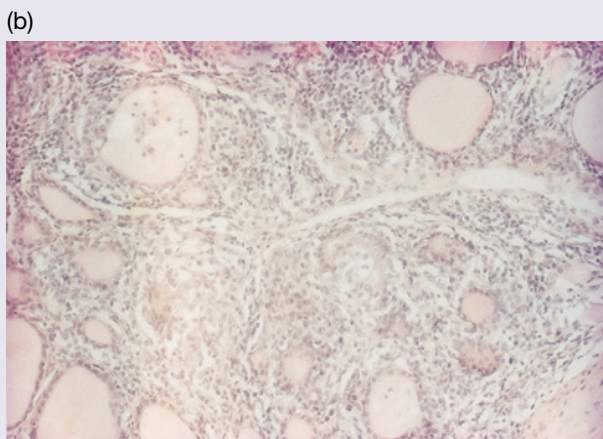
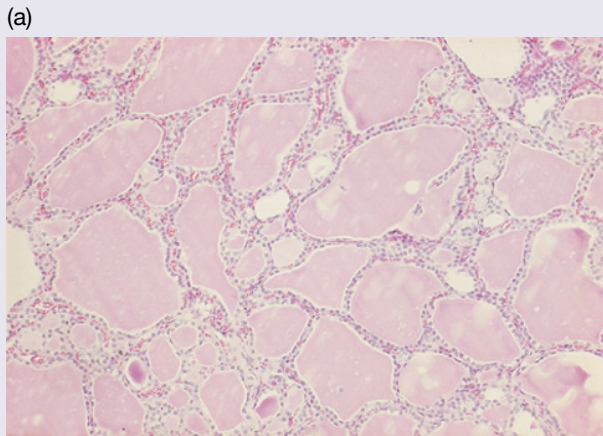


Figure M17.1.1 Experimental autoimmune thyroiditis. (a) The follicular architecture of the normal thyroid. (b) Thyroiditis produced by immunization with rat thyroid extract in complete Freund's adjuvant; the invading chronic inflammatory cells have destroyed the follicular structure. (Data source: Rose N.R. and Witebsky E. (1956) *Journal of Immunology* **76**, 417–427.) (c) Similarity of lesions in spontaneous human autoimmune disease to those induced in the experimental model.

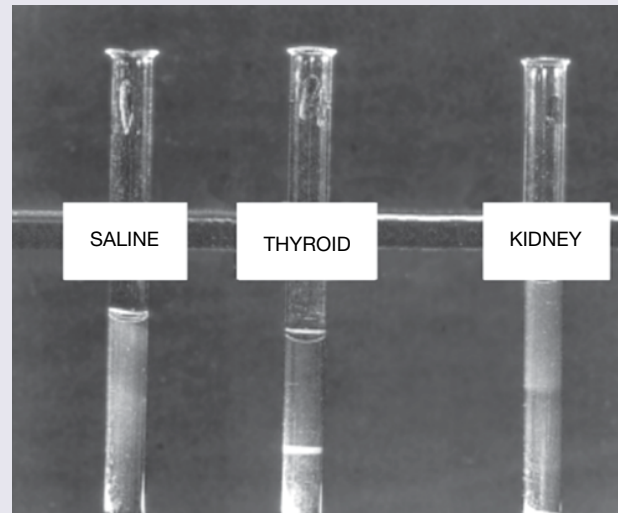


Figure M17.1.2 Thyroid autoantibodies in the serum of a patient with Hashimoto's disease demonstrated by precipitation in agar. Test serum is incorporated in agar in the bottom of the tube; the middle layer contains agar only, while the autoantigen is present in the top layer. As serum antibody and thyroid autoantigen diffuse towards each other, they form a zone of opaque precipitate in the middle layer. Saline and kidney extract controls are negative. (Adapted from Roitt I.M. *et al.* (1956) *Lancet* **ii**, 820–821. Reproduced with permission of Elsevier.)

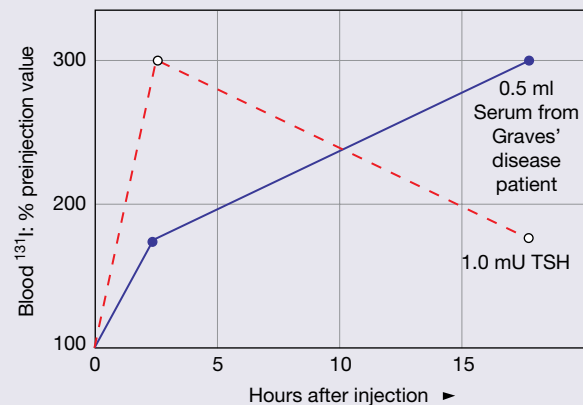


Figure M17.1.3 The long-acting thyroid stimulator in Graves' disease. Injection of TSH causes a rapid release of ¹³¹I from the prelabeled animal thyroid in contrast to the prolonged release that follows injection of serum from a Graves' disease patient. (Adapted from Adams D.D. and Purves H.D. (1956) *Proceedings of the University of Otago Medical School* **34**, 11–12.)

Table 17.2 The major autoimmune diseases. There are a large number of autoimmune diseases. Listed are the most prevalent diseases for which there is strong evidence that the primary cause of the pathology is an autoimmune attack. Other diseases which may also be autoimmune, but for which the pathological contribution of autoimmunity requires further investigation, are discussed later.

Disease	Indicative prevalence in White population* (%)	Characteristic autoantibodies
Graves' disease	1.12	TSH receptor (stimulatory)
Rheumatoid arthritis	0.92	Citrullinated proteins, IgG Fc
Hashimoto's disease	0.55	Thyroid peroxidase, thyroglobulin
Sjögren's syndrome	0.37	SS-A, SS-B
Pernicious anemia	0.15	Intrinsic factor
Multiple sclerosis	0.14	Myelin basic protein
Ankylosing spondylitis	0.13	Multiple connective tissue and skeletal proteins
Type 1 diabetes	0.12	Glutamic acid decarboxylase 65, insulin, insulinoma-associated autoantigen 2 (IA-2), zinc transporter 8 (ZnT8)
SLE	0.08	dsDNA, Sm, U1RNP, SS-A, SS-B, histones

*The actual prevalence will vary somewhat dependent upon ethnicity and geographical location.

What causes autoimmune disease?

Genetic factors

Autoimmune phenomena tend to aggregate in certain families. For example, the first-degree relatives (siblings, parents, and children) of patients with Hashimoto's disease show a high incidence of thyroid autoantibodies and of overt and subclinical thyroiditis. Parallel studies have disclosed similar relationships in the families of pernicious anemia patients, in that gastric parietal cell antibodies are prevalent in the relatives who develop achlorhydria (absent or low hydrochloric acid in gastric secretions) and atrophic gastritis. Turning to SLE, a sibling of a patient with this disease is 20 times more likely to develop lupus compared to the population as a whole. Figure 17.2 shows a multiplex family with type 1 diabetes in which the

Table 17.3 Spontaneous and induced animal models of autoimmune disease. A few examples from among the large number of such models. There are also a very large number of genetically engineered animal models.

Animal model	Human equivalent
Spontaneous	
Nonobese diabetic mouse (NOD)	Type 1 diabetes
Obese strain chicken	Hashimoto's disease
HLA-B27 transgenic rat	Ankylosing spondylitis
NZB mouse	Autoimmune hemolytic anemia
NZB × NZW F1	SLE
MRL/lpr mouse	SLE
Induced (by injection of antigens)	
Experimental autoimmune thyroiditis (EAT). Thyroglobulin in CFA into mice	Hashimoto's disease
Experimental autoimmune encephalomyelitis (EAE). Myelin basic protein in CFA into mice	Multiple sclerosis
Adjuvant arthritis. <i>Mycobacterium tuberculosis</i> in CFA into rats	Rheumatoid arthritis
Collagen-induced arthritis. Rat type II collagen in CFA into mice	Rheumatoid arthritis
Autoimmune hemolytic anemia. Rat RBC into mice	Autoimmune hemolytic anemia

CFA, Complete Freund's adjuvant.

disease is linked to a particular serologically defined HLA haplotype.

These familial relationships could be ascribed to environmental factors such as infective microorganisms, but there is powerful evidence that genetic components are involved. The data on *twins* is unequivocal. When Graves' disease or type 1 (insulin-dependent) diabetes occurs in twins, there is a far greater **concordance rate** (i.e., both twins affected) in identical than in nonidentical twins. Second, lines of animals have been bred that spontaneously develop autoimmune disease (see Table 17.3). In other words, **the autoimmunity is genetically programmed**.

The vast majority of autoimmune diseases involve multiple susceptibility genes in each patient (i.e., they are **polygenic**). For example, over 40 gene loci (including *MHC*, *insulin*, *PTPN22*, *CTLA4*, and *IL2RA*) have so far been identified that influence susceptibility to type 1 diabetes in humans. Conversely, there are a few incredibly rare instances where an inherited mutation in the *Foxp3* (resulting in IPEX [immune dysregulation, polyendocrinopathy, enteropathy, X-linked syndrome]), *AIRE*

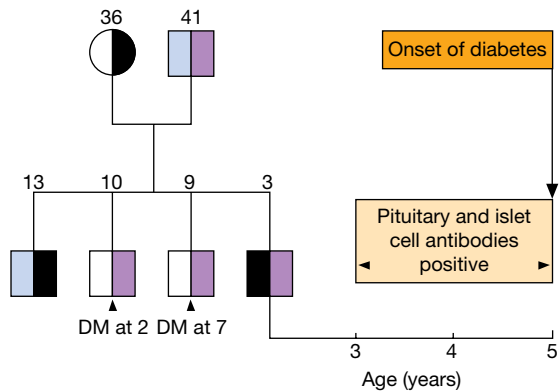


Figure 17.2 HLA haplotype linkage and onset of type 1 diabetes (DM). Haplotypes: □A3, B14, DR6; ■A3, B7, DR4; □A28, B51, DR4; and ■A2, B62, C3, DR4. Disease is linked to possession of the A2, B62, C3, DR4 haplotype. The 3-year-old brother had antibodies to the islet cell surface for 2 years before developing frank diabetes indicative of the lengthy pathological process preceding disease. (Data source: G.F. Bottazzo.)

(causing autoimmune polyendocrine syndrome-1) or either *Fas*, or *FasL* (autoimmune lymphoproliferative syndrome) genes are alone responsible. As discussed in Chapter 13, such diseases are therefore also classed as primary immunodeficiencies. Some idea of the much greater genetic complexity of conventional autoimmune diseases has been gained from genome-wide searches for susceptibility genes. Generally speaking, in both mice and humans, each gene alone confers only a small increased risk. It is the **combination** of these genes that results in a substantially enhanced chance of developing autoimmune disease.

The strongest genetic associations with autoimmune diseases is linkage to the **major histocompatibility complex (MHC)**: HLA in humans and H-2 in mice. Of the many examples in humans, three are the increased risk of type 1 diabetes for DQ8 individuals, and the higher incidences of DR3 in Addison's disease and of DR4 in RA (Table 17.4). It should be noted that such associations vary with ethnicity. For example, HLA-B27 shows an unusually strong linkage to ankylosing spondylitis and is present in 95% of White patients with this disease but in only 50% of African-American patients.

The use of antibodies to define MHC specificities is an informative approach, but with the improved precision gained by using gene sequencing it has become apparent that there is huge variation within each of the antibody-defined alleles. The naming of HLA alleles can therefore get quite complicated. However, a standardized nomenclature was widely adopted in 2010 and a very clear and detailed explanation can be found at <http://hla.alleles.org/nomenclature>. Thus, again using HLA-B27 as an example, the accumulation of sequence data from different individuals quickly led to an appreciation that there are many different variants of HLA-B27, conferring differing degrees of susceptibility. Just to take three examples: the

Table 17.4 Association of HLA with autoimmune disease. Relative risk refers to the chance of developing the disease compared to an individual who lacks the allele, and are for typical studies in White populations. These will often be different in other ethnic groups.

Disease	HLA allele	Relative risk
Class II associated		
Hashimoto's disease	DR5	3.2
Graves' disease	DR3	3.7
Type 1 diabetes	DQ8	14
	DQ2 + DQ8	20
	DQ6	0.2
Addison's disease	DR3	6.3
Rheumatoid arthritis	DR4	5.8
Sjögren's syndrome	DR3	9.7
Multiple sclerosis	DR2	3
Class I associated		
Ankylosing spondylitis	B27	87.4
Myasthenia gravis	B8	3

HLA-B*27:04 allelic variant is more strongly associated with ankylosing spondylitis than is HLA-B*27:05, while the HLA-B*27:06 allele shows only very weak or no association. As more data are accumulated, the precise variants that constitute disease susceptibility genes are becoming clearer. Some of the MHC associations that are seen are due to linkage disequilibrium with a disease susceptibility gene inherited *en bloc* with the MHC variant. However, it is often the case that it is the MHC gene itself that leads to an increased or decreased risk of developing a particular autoimmune disease. Even a single amino acid difference in the peptide-binding groove can have a profound impact on the spectrum of both self and foreign peptides that are presented. Thus, an aspartic acid at amino acid residue position 57 in the HLA-DQ β chain confers resistance to type 1 diabetes, whereas an alanine, valine, or serine at this position confers susceptibility. The close relationship to MHC is not altogether unexpected given that, as we shall see, autoimmune diseases are T-cell dependent and most T-cell responses are MHC restricted.

Among the plethora of non-MHC-linked loci are genes encoding autoantigens (e.g., TSH receptor, insulin), pattern recognition receptors (e.g., NOD2), cytokines (e.g., IL-12, IL-21) and their receptors (e.g., IL-7R and IL-23R), co-stimulatory molecules (e.g., CD40), signaling molecules (e.g., BLK, TRAF1) and transcription factors (e.g., STAT4, RORC). Polymorphisms in such genes enhance susceptibility or lead to resistance in otherwise predisposed subjects, and some have the potential to alter the balance of Th1/Th2/Th17/Treg subsets. Any polymorphism identified in more than one autoimmune

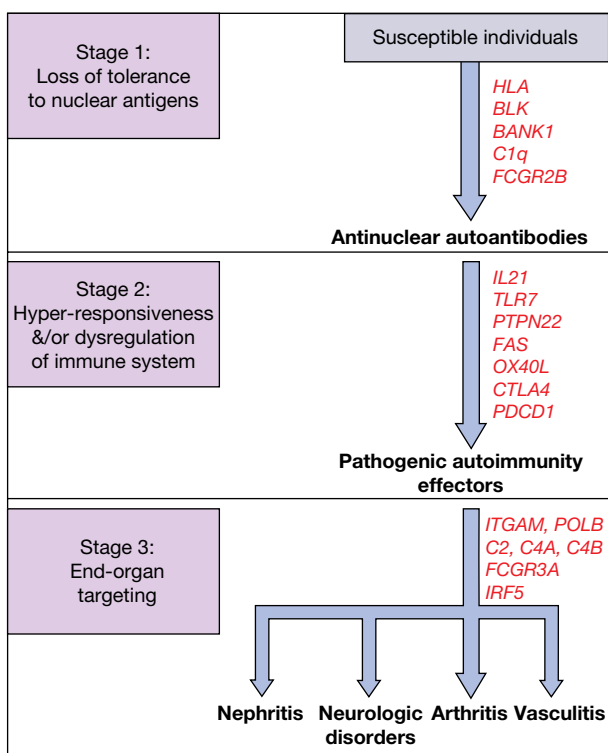


Figure 17.3 Possible stages in development of systemic lupus erythematosus (SLE) in susceptible individuals. An estimated 20–50 genes have been implicated in human SLE from genome-wide association studies, some examples of which are shown in red. *BLK*, B-lymphoid tyrosine kinase; *BANK1*, B-cell scaffold protein with ankyrin repeats-1; *IL21*, interleukin-21; *IRF5*, interferon regulatory factor-5; *ITGAM*, integrin α_m component of the CR3 complement receptor; *FCGR2B*, $Fc\gamma RIIb$; *FCGR3A*, $Fc\gamma RIIIa$; *PDCD1*, programmed cell death 1; *POLB*, DNA polymerase β .

disease is particularly noteworthy, a good example being *CTLA-4*, linked to a number of conditions including type 1 diabetes, Graves' disease, and RA. Variants of *PTPN22* have also been implicated in susceptibility to these and several other autoimmune diseases. Given that both the cell surface *CTLA-4* and the *PTPN22* intracellular tyrosine phosphatase are involved in inhibiting T-cell co-stimulation, it is perhaps unsurprising that defects in their expression or function could contribute toward development of normally suppressed autoimmune responses.

Unraveling such complex polygenic conditions is a very tough assignment. If we take SLE as archetypal, genetic analysis of the predisposition to disease is most compatible with a threshold liability model requiring additive and/or epistatic (suppressing the function of another gene) contributions of multiple susceptibility genes probably linked to different stages of disease pathogenesis (Figure 17.3).

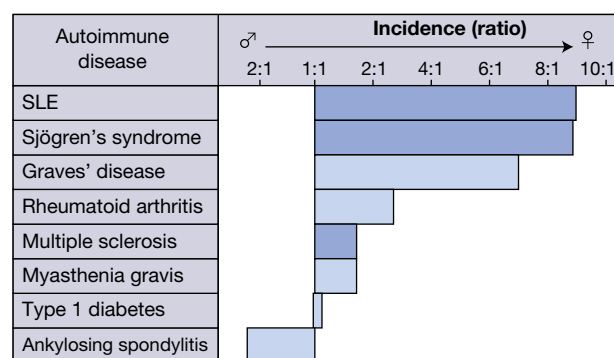


Figure 17.4 Increased incidence of autoimmune disease in females. Ankylosing spondylitis is one of very few autoimmune diseases that bucks the trend and is more common in men than in women.

Hormonal influences

Whether or not one is of the XX or XY genotype has a profound effect on many aspects of life! This includes a general trend for autoimmune disease to occur more frequently in women than in men (Figure 17.4) probably due, in essence, to differences in hormonal patterns. Indeed, collectively, 75% of autoimmune disease is found in women and most commonly arises during the childbearing years. The most striking gender bias is seen in SLE where, during this time of their life, women are approximately 10 times more likely to develop this disease than men. However, this drops to only a 2.5-fold excess following the menopause. There is a suggestion that higher estrogen levels are found in patients compared with controls. In glomerulonephritis, knocking out the estrogen receptor α chain in the NZB \times NZW mouse model lowers autoantibody levels, decreases the severity of glomerulonephritis, and increases survival (Figure 17.5).

Pregnancy is often associated with amelioration of autoimmune disease severity, for example in rheumatoid arthritis (RA), and there is sometimes a striking relapse after giving birth, a time at which there are drastic changes in hormones such as prolactin, not forgetting the loss of the placenta. Certainly a general quietening down of immune responses in order to prevent immunological rejection of the fetus would be consistent with some degree of remission of an autoimmune disease during pregnancy. However, there needs to be a degree of caution in making any generalized statement here because some autoimmune diseases, such as SLE, can actually get worse during pregnancy. It may be that the relative contribution of the various T-cell subsets to different types of autoimmune disease, and changes in these subsets during pregnancy, go some way to explaining these apparently opposite affects.

In Chapter 9, we looked at the importance of the neuroendocrine immune feedback encompassing the cytokine–hypothalamic–pituitary–adrenal control circuit. Abnormalities

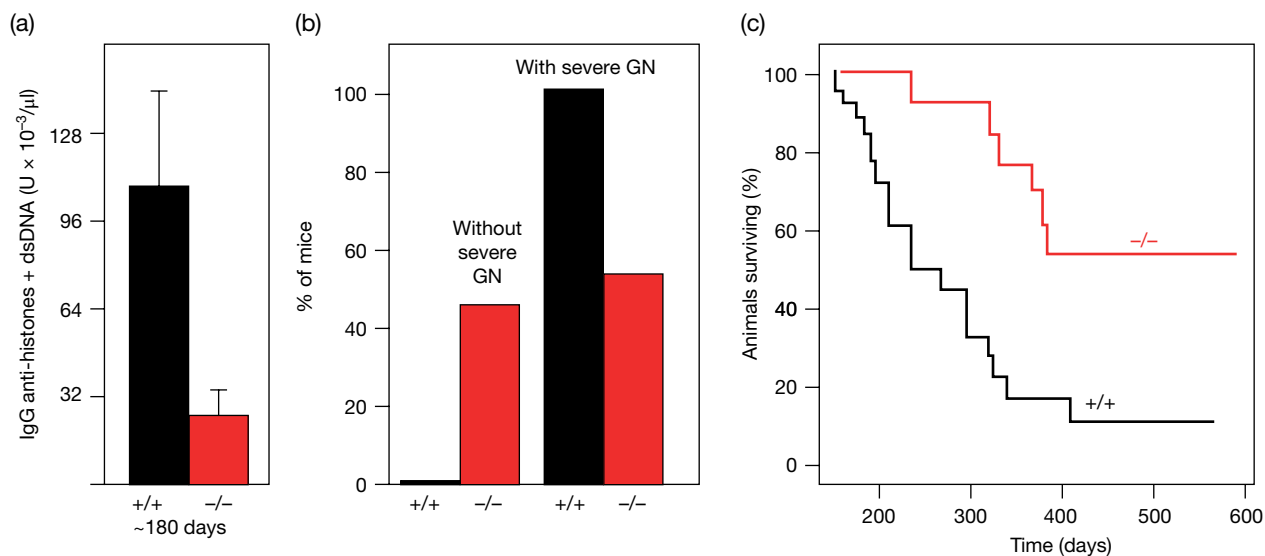


Figure 175 Estrogen receptor α -chain (ER α) knockout inhibits autoantibodies and nephritis, and prolongs lifespan in murine lupus. Female NZB \times NZW F1 mice bearing homozygous deletion ($-/-$) of the estrogen receptor α -chain: (a) develop lower levels of IgG autoantibodies to a histones/dsDNA mixture; (b) exhibit a reduced incidence of severe glomerulonephritis (GN) compared with ER $\alpha^{+/+}$ mice siblings; and (c) have an increased lifespan. (Data source: Bynoté K.K. *et al.* (2008) *Genes and Immunity* **9**, 137–152.)

in this feedback loop have now been revealed in several autoimmune disorders. RA patients with ongoing chronic inflammation have normal levels of circulating cortisol despite the presence of inflammatory cytokines that would normally be expected to stimulate increased secretion of this adrenal hormone. The Obese Strain (OS) chicken and several strains of lupus mice also show blunted IL-1 β -induced corticosteroid responses.

Does the environment contribute?

Twin studies

Concordance rates reported in the literature tend to vary somewhat from study to study, but consistently reinforce the fact that although there is a strong genetic contribution, inherited genes are not the whole story. Thus, even the relatively high 65% or so concordance rates that are reported for the development of type 1 diabetes in identical twins followed throughout life indicates very clearly that noninherited factors must also be involved. This is not necessarily all due to environment as, although monozygotic twins have identical germline immunoglobulin and T-cell receptor (TCR) genes, the processes of diversification of receptors and of internal anti-idiotypic interactions are so complex that the resulting receptor repertoires will be extremely variable and unlikely to be identical. Nonetheless, in many other autoimmune diseases, including Graves' disease and SLE, reported concordance rates in identical twins are only of the order 20–25%, leaving much room for other contributory factors. Although the genetics of autoimmune disease is at least partly

worked out, the nongenetic influences are relatively poorly understood – particularly in the human.

Diet

What environmental agents can we identify? Well, diet could be one although there is scant evidence so far for most autoimmune diseases. There is some evidence that iodine supplementation in iodine-deficient populations can lead to an increase in thyroid autoimmune disease, but this is a rather special case as the thyroid hormones are constructed from iodinated tyrosines and there is evidence to suggest that iodinated thyroglobulin has enhanced immunogenicity. Another special case is the immune response to gliadin, which is intimately associated with the development of celiac disease. Diet also has the potential to alter the microbiome and therefore can have indirect effects in any autoimmune diseases that are precipitated by infection.

Drugs

Although many autoimmune conditions have been linked in case reports to a wide range of drugs, the most firmly established example is **drug-induced lupus**. Procainamide and quinidine (both used to treat cardiac arrhythmia) and hydralazine (an antihypertensive drug) are most often implicated in this disease that shares many features with SLE, although the specificity of the anti-DNA tends to be towards the single-stranded form rather than double-stranded DNA (dsDNA) and patients tend to have more joint involvement and less neurological and kidney involvement.

Noninfectious environmental agents

Sunshine is an undisputed trigger of the skin lesions in SLE. Necrosis and apoptosis of keratinocytes resulting from the detrimental effects of sunlight leads to the release of nuclear autoantigens; in the case of apoptosis these are associated with the cell surface blebs that characteristically appear in this type of cell death. The situation is not helped by the defective phagocytosis seen in this disease, resulting in reduced clearance of apoptotic debris. UV irradiation also stimulates production of both CCL and CXCL chemokines by skin epithelial cells, resulting in recruitment of T-cells and dendritic cells into the inflammatory lesion.

Occupational exposure to a number of agents has been linked to the development of autoimmune disease. Particularly convincing associations are silica exposure with SLE, RA, and scleroderma. Solvents have been implicated in, for example, multiple sclerosis, and pesticides with RA. Cigarette smoking increases the risk of RA and of Hashimoto's and Graves' diseases. The mechanisms remain unclear.

Infection

The finger of suspicion is often pointed in the direction of an infectious microorganism, and there is indeed substantial evidence in animal models that infection can play an important role in the development of autoimmune disease. However, there is only one clear-cut example in humans: acute rheumatic fever following infection with group A *Streptococcus*. In 3–4% of untreated patients, usually children, who develop a sore throat due to *S. pyogenes* infection there is a resulting polyarthritis, carditis, and chorea (i.e., joint and heart inflammation together with involuntary movement). The link to the infection lies in the fact that the streptococcal M protein shares structural homology with cardiac myosin – a clear situation of molecular mimicry. Despite numerous other proposals of microbial involvement in the precipitation of autoimmune disease in genetically susceptible individuals, such links are still at the level of speculation owing to a lack of definitive evidence. In most cases of human autoimmune disease, the problem regarding the identification of putative infectious agents is the long latency period that makes it difficult to track down the initiating event (see Figure 17.2) and, secondly, viable organisms usually cannot be isolated from the affected tissues. Nonetheless the clear evidence of microbial influences in animal models is sufficiently compelling to suggest that the hunt to link pathogens to human autoimmune diseases is worth pursuing.

Further complexity is added by the knowledge that environmental microbes may sometimes *protect* against spontaneous autoimmune disease. The incidence of diabetes is greatly increased if NOD mice are kept in specific pathogen-free conditions, while Sendai virus inhibits the development of arthritis in the MRL/lpr mouse model of SLE. The extraordinary variation in incidence of diabetes in NOD colonies bred in a wide variety of different animal houses (Figure 17.6) testifies to the

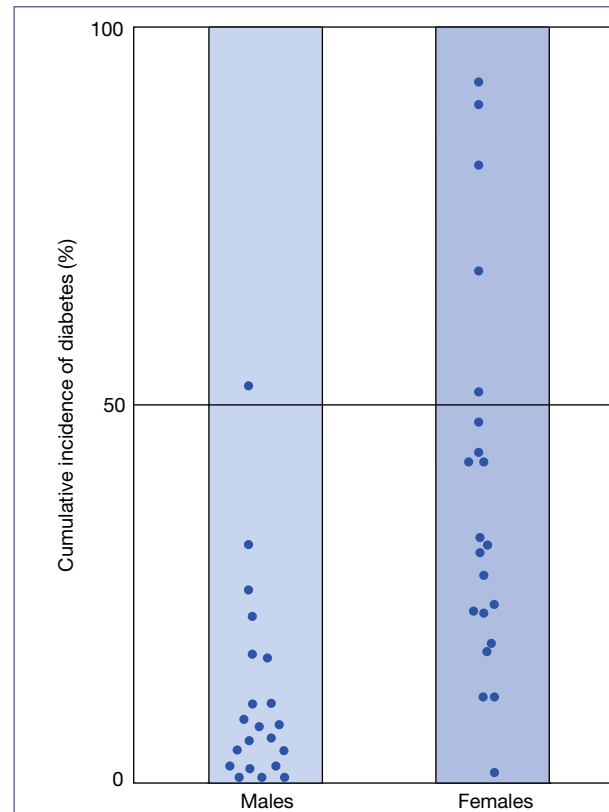


Figure 17.6 The incidence of spontaneous diabetes in geographically dispersed colonies of NOD mice at 20 weeks of age. Each point represents a single colony. The extreme spread of values is not attributable to genetic drift to any significant extent. The lower incidence in males is particularly evident. (Data source: Pozzilli P. et al. (1993) *Immunology Today* **14**, 193–196.)

dramatic influence of environmental flora on the expression of autoimmune disease.

Mechanisms in autoimmune disease

Although innate responses play important roles in the development and maintenance of autoimmune disease, at the most fundamental level pathogenic autoimmunity represents a breakdown in specific immunological tolerance. Given that tolerance is a mechanism that applies only to lymphocytes, the contribution of the adaptive response is blindingly obvious. Note also that we state “breakdown” in tolerance. It may be that in some cases there is a failure to establish tolerance in the first place, but given that autoimmune diseases often do not arise until early middle age or beyond it would seem that tolerance is initially operating effectively but that in genetically predisposed individuals an accumulation of environmental influences, and possibly mutations, eventually leads to uncontrolled pathogenic anti-self responses. Whether or not the response is driven by self antigen, foreign antigen, superantigens or other polyclonal activators, or by anti-idiotypes is not always entirely clear. It is also worth bearing in mind that a

seemingly identical autoimmune disease may arise because of different sets of circumstances in individual patients.

Tolerance is not absolute

Of the various tolerance mechanisms employed by the immune system, only apoptosis leads to a loss of antigen-specific lymphocytes. Although high-affinity B-cells will be tolerized by apoptosis, particularly to autoantigens that circulate at high concentration, this most extreme way of dealing with unruly lymphocytes is largely targeted at T-cells during negative selection in the thymus. Receptor editing can eliminate autoreactive B-cells through continued V(D)J recombination. Those self-reactive B-cells that are present in the periphery usually do not pose a problem owing to a lack of cognate T-cell help (see Figure 10.13). However, for autoantigens that are not expressed at an adequate level in the thymus, self-reactive T-cells will be available. Processing of an autoantigen will lead to certain (dominant) peptides being preferentially expressed on antigen-presenting cells (APCs) while others (cryptic) only appear in the MHC groove in very low concentrations which, although capable of expanding their cognate T-cells in the context of thymic positive selection, may nonetheless fail to provide a sufficiently powerful signal for negative selection of these cells. As a consequence, autoreactive T-cells specific for *cryptic epitopes* will survive in the repertoire that will therefore be biased towards weak self-reactivity.

Autoantigen-driven responses

The already mentioned Obese Strain (OS) chicken is unlikely to appear on the menu of your local restaurant, but this animal model of Hashimoto's disease spontaneously develops IgG autoantibodies to thyroglobulin and a chronic inflammatory antithyroid response that destroys the gland, so causing hypothyroidism. If the source of antigen is removed by neonatal thyroidectomy, no autoantibodies are formed. Injection of these animals with normal thyroglobulin then induces antibodies. Thyroidectomy of OS chickens with established thyroiditis is followed by a dramatic fall in antibody titer. Conclusions: the spontaneous antithyroglobulin immunity is initiated and maintained by autoantigen from the thyroid gland. Furthermore, as the response is completely T-cell dependent, we can infer that both B- and T-cells are driven by thyroglobulin in this model.

As usual, human disease is a tougher nut to crack and one has to rely on more indirect evidence. T-cell lines have been established from Graves' disease glands and it has been possible to show direct stimulation by whole thyroid cells. Removal of the putative antigen source by thyroidectomy of Hashimoto's disease patients is followed by a fall in serum gammaglobulins, one of the clues that led to the discovery of thyroid autoimmunity (see Milestone 17.1); incidentally, this accords well with the data from OS chickens quoted above. The production of high-affinity IgG autoantibodies accompanied by somatic hypermutation in patients with thyroid autoimmune disease is

powerful evidence for the selection of B-cells by antigen in a T-dependent response. The reason for this, simply, is that high-affinity IgG antibodies only arise through mutation and selection by antigen within germinal centers. More indirect, but equally convincing, is the argument that antibodies are regularly formed against a cluster of epitopes on a single autoantigen or of autoantigens within a single organ (e.g., thyroglobulin plus thyroid peroxidase, or different constituents of the nucleosome). It is difficult to propose a hypothesis which does not depend finally on stimulation by antigen. T-cells are critical for such responses, as depletion of CD4 T-cells in a number of animal models abrogates autoantibody production.

The visibility of autoantigens to the immune system

For a few body constituents (e.g., sperm, lens, and heart) the antigens are completely *sequestered* (hidden) from the immune system and therefore no degree of immunological tolerance is established. This does not pose a problem unless a mishap (e.g., physical trauma) causes release of the antigen into the circulation with subsequent activation of self-reactive lymphocytes. Even here, in general, the experience has been that injection of unmodified extracts of those tissues concerned in the organ-specific autoimmune disorders does not readily elicit antibody formation.

In the majority of cases (e.g., red blood cells in autoimmune hemolytic anemia, ribonucleoprotein [RNP] and nucleosome components present as blebs on the surface of apoptotic cells in SLE, and surface receptors in many cases of organ-specific autoimmunity), the autoantigens are readily accessible to circulating lymphocytes. Presumably, antigens present at adequate concentrations in the extracellular fluid will be processed by professional APCs, but for autoantigens associated with cells, the derivative peptides will only interact "meaningfully" with specific T-cells if there are appropriate MHC surface molecules, if the concentration of processed peptide associated with them is significant, and, for resting T-cells, if co-stimulatory signals can be given. As we shall see, these are important constraints.

The message then is that we are all sitting on a minefield of self-reactive cells, with potential access to their respective autoantigens. However as autoimmune disease only occurs in a minority of the population the body must possess homeostatic mechanisms to prevent such self-reactive cells being triggered under normal circumstances. It is assumed that the key to the system is control of the autoreactive T-helper cell as the evidence heavily favors the T-dependence of virtually all autoimmune responses; thus, interaction between the T-cell and MHC-associated peptide becomes the core consideration. We start with the assumption that these cells are normally unresponsive because of clonal deletion, clonal anergy, T-suppression, or inadequate autoantigen presentation. Immediately, one could conceive of an abnormal degree of responsiveness to self antigens as a result of relatively low intrathymic expression of a particular molecule. Abnormalities in the signaling pathways

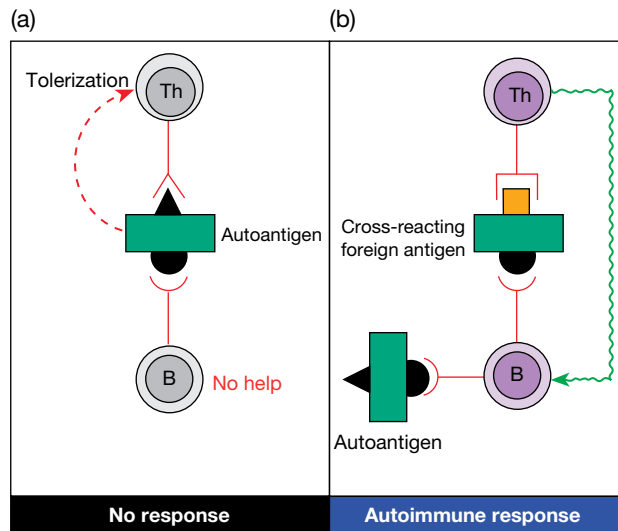


Figure 17.7 Autoimmunity can arise through bypass of self-reactive T-cells. The absence of functional self-reactive helper T-cells can be circumvented by microbial cross-reactive antigens that share some, but not all, epitopes with self antigens. (a) Functional self-reactive T-cells are absent (owing to deletion, anergy, or suppression) and therefore there is no help for any self-reactive B-cells. Remember that T-cells are generally more susceptible to tolerance than are B-cells. The deleted (T) and non-responsive (B) lymphocytes are indicated in gray. (b) Epitopes that are unique to the microbial antigen can be processed and presented to helper T-cells. Because these epitopes are physically linked to the cross-reactive epitopes the autoantigen-specific helper T-cell is bypassed and the microbe-specific T-cell can now provide help for the self-reactive B-cell (or indeed for any nontolerized cytotoxic T-cells). For simplicity, processing for MHC association has been omitted from the diagram.

affecting the thresholds for positive and negative selection in the thymus would also affect subsequent responsiveness to peripheral autoantigens. So might defects in apoptotic cell death.

Obtaining T-cell help for autoantigen-specific B-cells

James Allison and William Weigle argued independently that, if autoreactive T-cells are tolerized and thereby unable to collaborate with B-cells to generate autoantibodies (Figure 17.7a), provision of new carrier determinants (i.e., helper T-cell epitopes) to which no self-tolerance had been established would provide a “T-cell bypass.” In other words, help could now be given for autoreactive B-cells even though the autoreactive T-cells were absent, leading to autoantibody production (Figure 17.7b).

Modification of the autoantigen

A new carrier could arise through posttranslational modification to the molecule, seen for example in the citrullination (a post-translational arginine modification) of vimentin, fibrinogen,

collagen type II, and α -enolase in RA. Modification can also be achieved through combination with a drug. In one example of many, the autoimmune hemolytic anemia associated with administration of α -methyl-dopa might be attributable to modification of the red blood cell surface in such a way as to provide a carrier for stimulating B-cells that recognize the rhesus antigen. This is normally regarded as a “weak” antigen and would be less likely to induce B-cell tolerance than the “stronger” antigens present on the erythrocyte.

Molecular mimicry of T-cell epitopes

B-cell epitopes present on a microbial antigen may cross-react, as a result of molecular mimicry, with an epitope on a human autoantigen. However, because the microbial antigen and the self antigen are only partially similar there will be no T-cell tolerance to sequences on other parts of the microbial antigen. Thus, T-cells to these sequences will be present and can provide help for B-cells that recognize the cross-reactive epitope (Figure 17.7b). We have already mentioned that in rheumatic fever antibodies produced to the *Streptococcus* also react with heart. Another, somewhat less established, example is the envelope proteins of *Yersinia enterocolitica* which share epitopes with the thyroid-stimulating hormone (TSH) receptor.

The drawback of this B-cell epitope cross-reaction model is that once the cross-reacting agent is eliminated from the body the T-cell epitope will no longer be present. However, the infecting agent may also mimic an autoantigen by producing a **cross-reacting microbial T-cell epitope** on professional APCs that can prime the T-cell and upregulate its adhesion molecules. The T-cell now has the **avidity** to bind to and be persistently activated by the **self epitope** presented on the target tissue cell provided that it is associated with the appropriate MHC molecule. Theoretically, the resting T-cell could also be primed in a non-antigen-specific manner by a microbial **superantigen**.

Although we have ascribed the dominant role of MHC alleles as risk factors for autoimmune diseases to their ability to present key antigenic epitopes to autoreactive T-cells, they might also operate in a quite distinct way. We may recollect that, during intrathymic ontogeny, T-cells are positively selected by weak interaction with self peptides complexed with MHC. Now as around **50% of the class II peptides are MHC derived**, then the mature T-cells leaving the thymus will have been selected with a strong bias to weak recognition of self MHC peptides presented by class II. There must therefore be a major pool of self-reactive T-cells vulnerable to stimulation by exogenously derived cross-reacting epitopes that mimic these MHC peptides. Just so. The sequence QKRAA (the so-called “shared epitope” sequence) lies within a polymorphic region of the DR β chain of DR1 and certain DR4 alleles, and is also present in the dnaJ heat-shock proteins from *E. coli*, *Lactobacillus lactis*, and *Brucella ovis*, as well as the Epstein–Barr virus gp110 protein. This provides an opportunity for priming of T-cells with autoreactive specificity for a processed

Table 17.5 Molecular mimicry. Some examples of homologies between microbes and body components as potential cross-reacting T-cell epitopes.

Disease	Microbial molecule	Sequence
Rheumatoid arthritis	Microbe: <i>Escherichia coli</i>	QKRAAVDTY
	Self: HLA-DRB1*04:01	QKRAAYDQY
Multiple sclerosis	Microbe: Epstein–Barr virus	VYHFVKKHV
	Self: Myelin basic protein	VVHFFKNIV
Multiple sclerosis	Microbe: <i>Chlamydia pneumoniae</i>	YGCLLPNRPRTEDQN
	Self: Myelin basic protein	YGSLPQKSQRTQDEN
Type 1 diabetes	Microbe: Hepatitis C virus	AAARRWAC
	Self: Glutamic acid decarboxylase 65	AAARKAAC
Myasthenia gravis	Microbe: Polio virus	TKESRGTT
	Self: Acetylcholine receptor	IKESRGTK
Rheumatic fever	Microbe: <i>Streptococcus pyogenes</i>	LTDQNKNLTTEN
	Self: Cardiac myosin	LTSQRAKLQTEN

peptide containing QKRAA presented by another HLA molecule. Thus, the sequence QKRAAVDTY of the RA susceptibility allele HLA-DRB1*04:01 is closely similar to the QKRAAYDQY of the dnaJ heat-shock protein of *E. coli* (Table 17.5), and this peptide presented by DQ causes proliferation of synovial T-cells from RA patients.

In fact, a large number of microbial peptide sequences with varying degrees of homology with human proteins have been identified (Table 17.5), although it should be emphasized at this stage that they only provide clues for further study.

The mere existence of homology provides no evidence that infection with that organism will necessarily lead to autoimmunity, because everything depends on several contingencies, including the manner in which the proteins are processed by the APCs.

“Piggy-back” T-cell epitopes and epitope spread

One membrane component may provide help for the immune response to another (associative recognition). In the context of autoimmunity, a new helper determinant may arise through drug modification as mentioned above, or through the insertion of viral antigen into the membrane of an infected cell. That this can promote a reaction to a pre-existing cell component is clear from the studies in which infection of a tumor with influenza virus elicited resistance to uninfected tumor cells. In a comparable fashion, T-cell help can be provided for a molecule such as DNA, which cannot itself

form a T-cell epitope, by complexing with a T-dependent carrier such as a histone. When this is recognized by the B-cell receptor, the helper component will be “piggy-backed” into the B-cell, processed and presented as an epitope for recognition by T-cells (Figure 17.8). By the same token, the autoimmune response can spread to other epitopes on the same molecule.

Idiotype bypass mechanisms

Lymphocytes with specificity for exogenous antigens could be connected to autoreactive lymphocytes through idiotype network connections (Figure 17.9). Thus, it is conceivable that an environmental agent such as a parasite or virus could trigger antibody carrying a cross-reactive idiotype which happened to be shared with the receptor of an autoreactive T- or B-cell, and thereby provoke an autoimmune response.

Polyclonal activation

Microbes often display adjuvant properties through their possession of polyclonal lymphocyte activators such as bacterial endotoxins. The variety of autoantibodies detected in cases with infectious mononucleosis must surely be attributable to the polyclonal activation of B-cells by the Epstein–Barr virus (EBV). Nevertheless, it is difficult to see how a pan-specific polyclonal activation could give rise to the patterns of autoantibodies characteristic of the different autoimmune disorders without the operation of some antigen-directing factor.

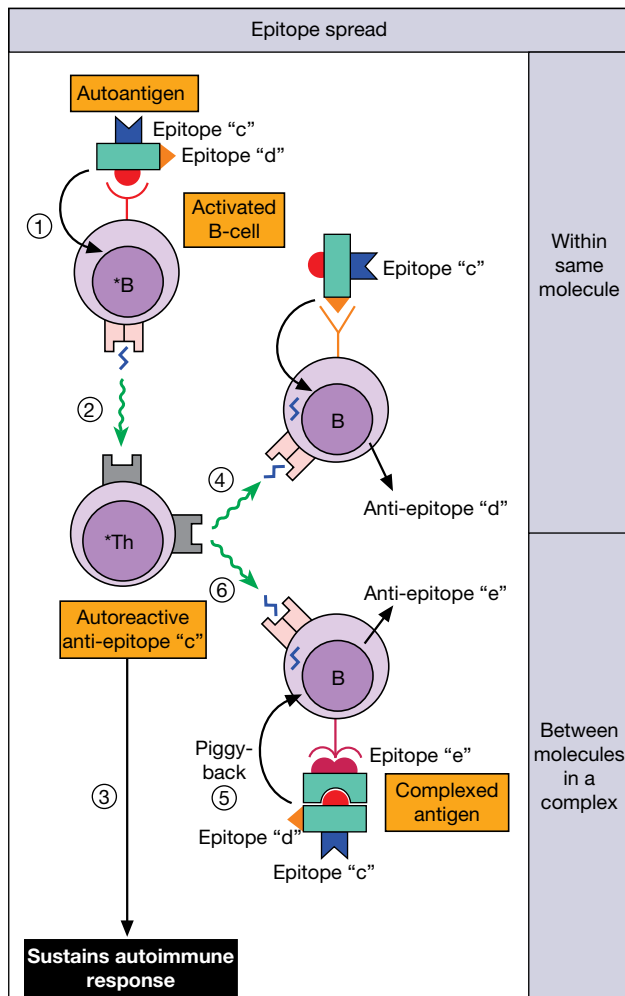


Figure 17.8 Epitope spread. If the autoantigen is soluble or capable of uptake and processing after capture by an activated autoreactive B-cell (1), a new epitope can be presented on the B-cell class II which now stimulates an autoreactive (anti-epitope "c") T-helper (2), which can then sustain an autoimmune response entirely through autoantigen stimulation (3). It can also produce epitope spread within the same molecule through helping a B-cell which captures the autoantigen through a new epitope "d" (4), or to another component (epitope "e") in an intermolecular complex such as nucleosomal histone–DNA which "piggy-backs" the molecule bearing epitopes "c" and "d" into the B-cell (5). Processed antigen is presented by the B-cell to the T-helper cell (6). *Denotes activation.

However, one could envisage scenarios in which polyclonally activated B- or T-cells might contribute to a sustained autoimmune response.

Regulatory defects

It should be emphasized that these T-helper bypass mechanisms for the induction of autoimmunity do not by themselves ensure the continuation of the response, as normal animals

have been shown to be capable of damping down autoantibody production through CD4 regulatory T-cell interactions as, for example, in the case of red blood cell autoantibodies induced in mice by injection of rat erythrocytes (Figure 17.10). Much work has focused on the CD4⁺CD25⁺Foxp3⁺ regulatory T-cell (see Figure 9.14) that has been shown to suppress many different autoimmune phenomena. To give just one of a huge number of examples, the proliferative capacity of Treg cells in response to human myelin basic protein in patients with the relapsing remitting form of multiple sclerosis declines in parallel with clinical disease (Figure 17.11).

Yet another player in the field is the NKT cell, which is deficient in NOD mice but can prevent the development of diabetes if transferred from F1(BALB/c×NOD) donors. Patients with a variety of autoimmune diseases have also been reported to have reduced numbers or function of this cell type.

Do abnormalities in apoptotic mechanisms also contribute to these regulatory defects? T- and B-cells of NOD mice are resistant to apoptosis, as are lymphocytes of the MRL/*lpr* lupus mouse strain that has a *fas* gene mutation. This mutation produces the characteristic lymphoproliferation, and possibly failure to limit the expansion of self-reactive T- and B-cell clones by apoptosis. The *gld* lupus model complements this situation with mutations in the *fas ligand*.

Attention has also focused on the regulatory IgG receptor on B-cells, the function of which is feedback control through surface immune complex signaling. Dysfunction in the FcγRIIB B-cell receptor in lupus-prone mice can be corrected by retroviral transduction of a normal gene (Figure 17.12).

We have previously drawn attention to the distinctive properties of the B-1 population with respect to its propensity to synthesize IgM autoantibodies and its possible intimate relationship to the setting up of the regulatory idiochrome network, and one must seriously entertain the hypothesis that unregulated activity by these cells could be responsible for certain autoimmune disorders. In humans, a high proportion of B-1 cells make IgM rheumatoid factors (anti-Fcγ) and anti-DNA using germline genes.

Aberrant expression of MHC class II

Normally, only professional antigen presenters such as dendritic cells express MHC class II molecules. Therefore the majority of organ-specific autoantigens usually appear on the surface of the cells of the target organ in the context of class I (present on all nucleated cells) but not class II. Thus the autoantigens cannot be presented to T-helpers by the tissue cells that are therefore immunologically silent. Ricardo Pujol-Borrell, Gian Franco Bottazzo, and colleagues reasoned that, if the class II genes were somehow derepressed and class II molecules were now synthesized, they would endow these cells with the ability to present peptides to CD4⁺ T-cells. Indeed, they were able to show that human thyroid cells in tissue culture can be persuaded to express HLA-DR (class II) molecules on their surface after stimulation with interferon-γ (IFNγ).

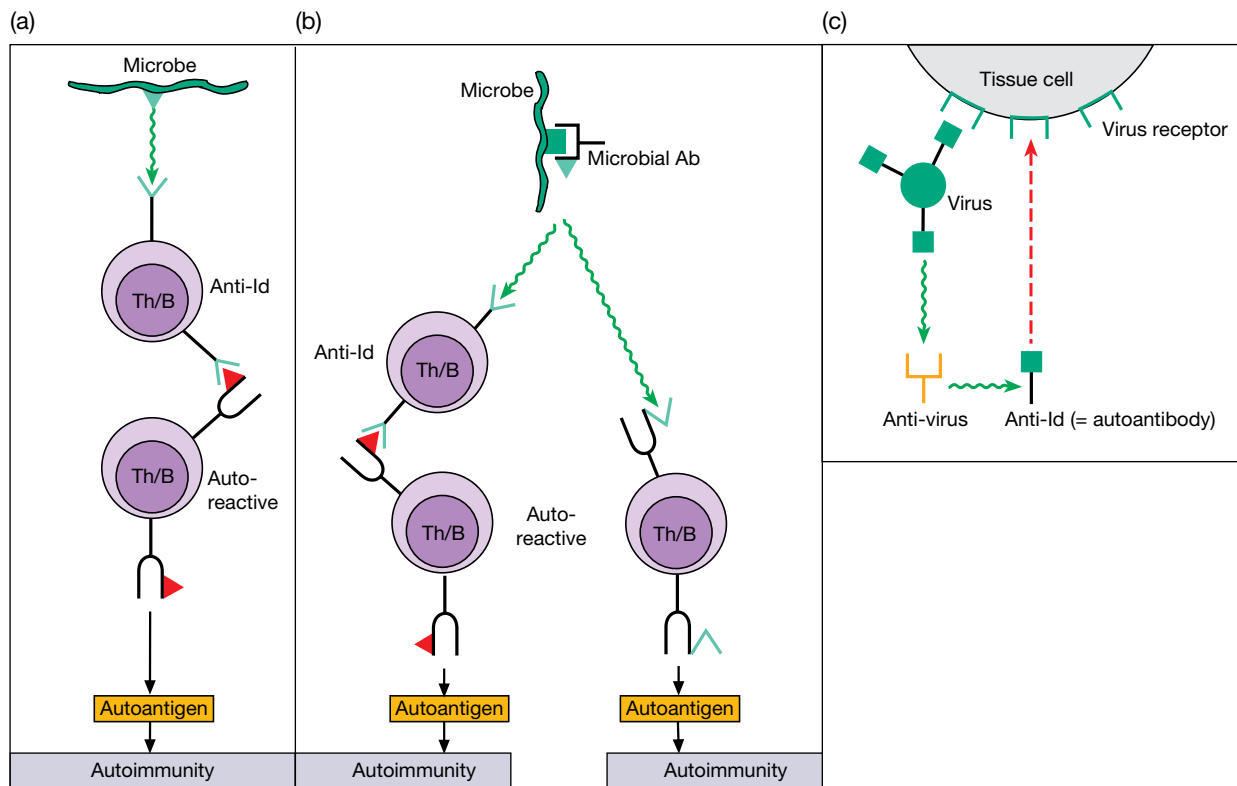


Figure 17.9 Putative idiotypic (Id) mechanisms leading to autoimmunity. (a) Microbial antigen cross-reacts with autoreactive lymphocyte idiotypes. (b) Microbial antibodies either share idiotypes with, or are anti-idiotype to, autoreactive lymphocytes. (c) Antivirus generates anti-idiotype that is autoantibody to viral receptor.

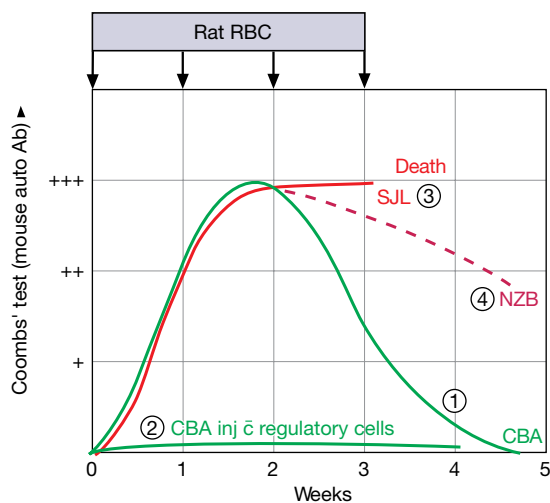


Figure 17.10 Regulation of self-reactivity. When CBA strain mice (1) are injected with rat red blood cells (RBC), autoantibodies are produced by this cross-reacting antigen that coat the host mouse erythrocytes and are detected by the Coombs' antiglobulin test. Despite repeated injections of rat erythrocytes, the autoantibody response is switched off by the expansion of CD4 mouse red blood cell-specific regulatory cells that do not affect antibody production to the heterologous erythrocyte determinants. When these regulatory cells are injected into naive CBA mice (2), rat RBCs cannot induce autoantibodies. The SJL strain (3), in which suppressor activity declines rapidly with age, is unable to regulate the autoimmune response and develops particularly severe disease. The response is also prolonged in the autoimmune NZB strain (4). (Data source: Cooke A. and Hutchings P. (1984) *Immunology* 51, 489–492.)

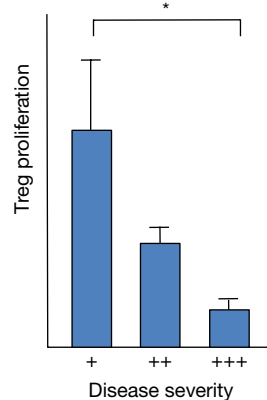


Figure 17.11 Regulatory T-cell defect in patients with relapsing remitting multiple sclerosis. The ability of CD4⁺ Foxp3⁺ regulatory T-cells to respond to stimulation with human myelin basic protein (MBP) correlates with the stage of clinical disease. (* $p < 0.01$, mean \pm s.e.m.) (Data source: Carbone F. *et al.* (2014) *Nature Medicine* 20, 69–74.)

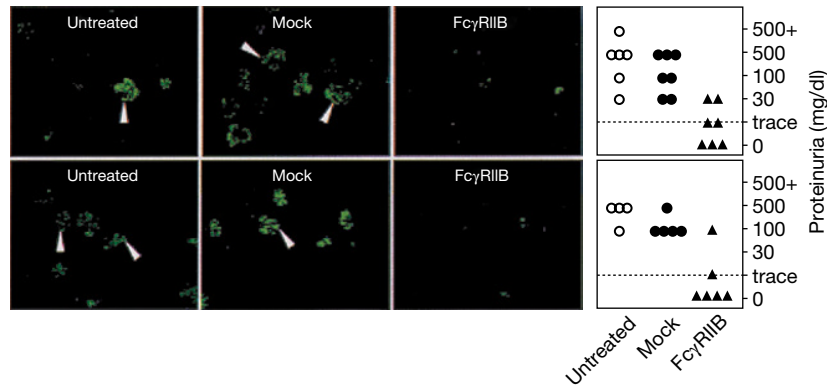


Figure 17.12 Retroviral transduction of the regulatory IgG receptor on B-cells ($Fc\gamma RIIB$) in spontaneous lupus-prone mice. Six months after receiving $Fc\gamma RIIB$ retroviral-transduced bone marrow, immune complex deposition is reduced and kidney function is improved in NZM2410 (top row) and BXSB (bottom row) lupus-prone mice. Kidney sections were examined for the presence of IgG complexes with direct immunofluorescence ($\times 40$). Arrowheads indicate subendothelial complexes indicative of active lupus. (Source: McGaha T.L. *et al.* (2005) *Science* **307**, 590–593. Reproduced with permission of AAAS.)

Inappropriate class II expression has also been reported on the bile ductules in primary biliary cirrhosis and on endothelial cells and some β -cells in the pancreas of type 1 diabetics.

Whether aberrant expression of class II on these cells through activation by something like virally induced IFN is responsible for initiating the autoimmune process by priming autoreactive T-helpers, or whether reaction with already activated T-cells induces class II by release of $IFN\gamma$ and makes the cell a more attractive target for provoking subsequent tissue damage, is still an unresolved issue. However, transfection of mice with the class II *H-2A* genes linked to the insulin promoter led to expression of class II on the β -islet cells of the pancreas but did not induce autoimmunity. Lack of B7 costimulatory molecules seems to be responsible for the failure of these class II-positive β -cells to activate naive T-cells, a job that may have to be left to the professional APCs.

Cytokine imbalance may induce autoimmunity

By contrast, transfection with the *IFNG* gene on the insulin promoter under the same circumstances produced a local inflammatory reaction in the pancreas with aberrant expression of class II *and* diabetes; this must have been a result of autoimmunity as a normal pancreas grafted into the same animal suffered a similar fate. This situation implies that unregulated cytokine production producing a local inflammatory reaction can initiate autoimmunity, probably by enhancing the presentation of islet antigen by recruiting and activating dendritic cells, by increasing the concentration of processed intracellular autoantigen available to them, and by increasing their avidity for naive T-cells through upregulation of adhesion molecules; perhaps previously anergic cells may be made responsive to antigen. Once primed, the T-cells can now interact with the islet β -cells that will be displaying increased amounts of class II and adhesion molecules for T-cells on their surface.

Turning to human disorders, a window on cytokine activity in SLE has been provided by analysis showing expression of a number of genes known to be upregulated by interferon- α (Figure 17.13) and elevated levels of the cytokine that correlate with more severe disease.

Pathogenic effects of autoantibody

We should now look at the evidence that helps to uncover the mechanisms by which autoimmunity, however it arises, plays a *primary pathogenic role* in the production of tissue lesions within the group of diseases labeled as “autoimmune.” Let us look first at autoantibody effectors.

Blood cells

The anti-erythrocyte antibodies play a dominant role in the destruction of red blood cells in *autoimmune hemolytic anemia*. Normal red blood cells coated with autoantibody eluted from Coombs' positive erythrocytes (see Figure 14.18) have a shortened half-life after reinjection into the normal subject, essentially as a result of their adherence to $Fc\gamma$ receptors on phagocytic cells in the spleen.

Lymphopenia occurring in patients with SLE and RA may be a direct result of antibody, as non-agglutinating antibodies coating the white cells have been reported in such cases.

Platelet antibodies are apparently responsible for *idiopathic thrombocytopenic purpura (ITP)*. IgG from a patient's serum when given to a normal individual causes a depression of platelet counts and the active component can be absorbed out with platelets. The transient neonatal thrombocytopenia that may be seen in infants of mothers with ITP is explicable in terms of transplacental passage of IgG antibodies to the child.

The primary *antiphospholipid syndrome* is characterized by recurrent venous and arterial thromboembolic phenomena,

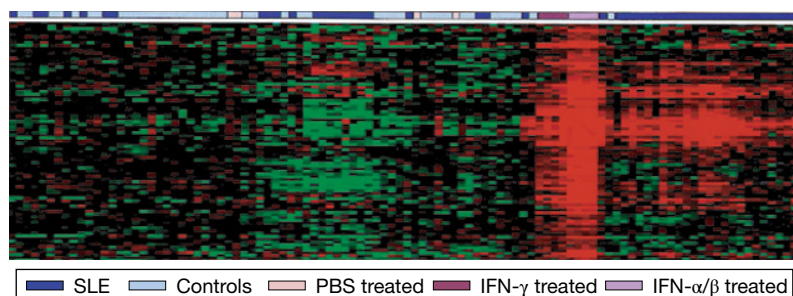


Figure 17.13 The IFN α signature in a major subset of patients with systemic lupus erythematosus (SLE). Expression patterns of IFN-induced genes in the blood of lupus patients and controls (red = highly expressed). The black bar indicates 22 of the IFN-upregulated genes that delineate the “signature pattern.” (Source: Baechler E.C. *et al.* (2004) *Current Opinion in Immunology* **16**, 801–807. Reproduced with permission of Elsevier.)

recurrent fetal loss, thrombocytopenia, and anti-phospholipid antibodies (such as anti-cardiolipin and anti- β_2 -glycoprotein 1 antibodies). Passive transfer of such antibodies into mice is fairly devastating, resulting in lower fecundity rates and recurrent fetal loss. Anti- β_2 -glycoprotein 1 antibodies activate endothelial cells, monocytes, and platelets, ultimately resulting in thrombosis. The placental trophoblast is a primary target of these antibodies as the villous cytotrophoblast is one of the few cell types that externalizes phosphatidyl serine during development.

Surface receptors

Thyroid

Under certain circumstances, antibodies to the surface of a cell may stimulate rather than destroy (see “stimulatory hypersensitivity” in Chapter 14). This is certainly the case in **Graves’ disease**, where a direct link with autoimmunity came with the discovery by Duncan Adams and Herbert Purves of thyroid-stimulating activity in the serum of these patients (see Milestone 17.1), ultimately shown to be due to the presence of antibodies to TSH receptors (TSHRs), which mimic the effect of TSH (Figure 17.14a). Under constant stimulation by the autoantibody an enlarged thyroid (referred to as a **goiter**) results, leading to **hyperthyroidism** (an overactive thyroid). This hyperthyroidism is often accompanied by exophthalmos (where the eyes bulge out from the orbit) that is probably due to inflammation caused by the fact that the TSHR is also expressed on orbital fibroblasts. It is one of Nature’s “passive transfer experiments” that links TSHR antibodies most directly with the pathogenesis of Graves’ disease.

When thyroid-stimulating antibodies from a pregnant female cross the placenta they cause the production of a neonatal hyperthyroidism (neonatal thyrotoxicosis) (Figure 17.15). This is essentially a transient form of Graves’ disease in the offspring, except that in this case it is caused by maternal autoantibody and is thus not an “autoimmune” disease in the infant. IgG has a half life of around 3 weeks and therefore the

neonatal disease resolves after a few weeks as the maternal IgG is catabolized. Also remember, though, that the class switching to IgG that has occurred in the mother required T-cell assistance. Therefore, although antibody seems quite clearly to be the effector in Graves’ disease, the primary defect in the immune response may well lie elsewhere, for example at the level of the dendritic cell, helper T-cell, or regulatory T-cell.

In **Hashimoto’s disease** there is a destructive thyroiditis resulting in **hypothyroidism**, with damage thought to be caused by thyroid-infiltrating CD8⁺ cytotoxic T-cells and also possibly by complement-fixing IgG autoantibodies (Figure 17.14b).

Muscle and nerve

The transient muscle weakness seen in a small proportion of babies born to mothers with **myasthenia gravis** would, as in Graves’ disease, be compatible with the transplacental passage of an IgG. In this case the antibody would be capable of inhibiting neuromuscular transmission. Strong support for this view is afforded by the consistent finding of antibodies to muscle acetylcholine receptors (AChRs) in people with myasthenia and the depletion of these receptors within the motor endplates. In addition, myasthenic symptoms can be induced in animals by injection of monoclonal antibodies to AChR or by active immunization with the purified receptors themselves. Nonetheless, the majority of babies with myasthenic mothers do not display muscle disease and, as appears to be the case in other transient neonatal diseases caused by maternal antibody, this relates largely to the levels of autoantibodies present in the mother.

Neuromuscular defects can also be elicited in mice injected with serum from patients with the **Lambert–Eaton** syndrome containing antibodies to presynaptic calcium channels. Autoantibodies to sodium channels that cross-react with campylobacter bacilli have been identified in **Guillain–Barré syndrome**, a self-resolving peripheral polyneuritis.

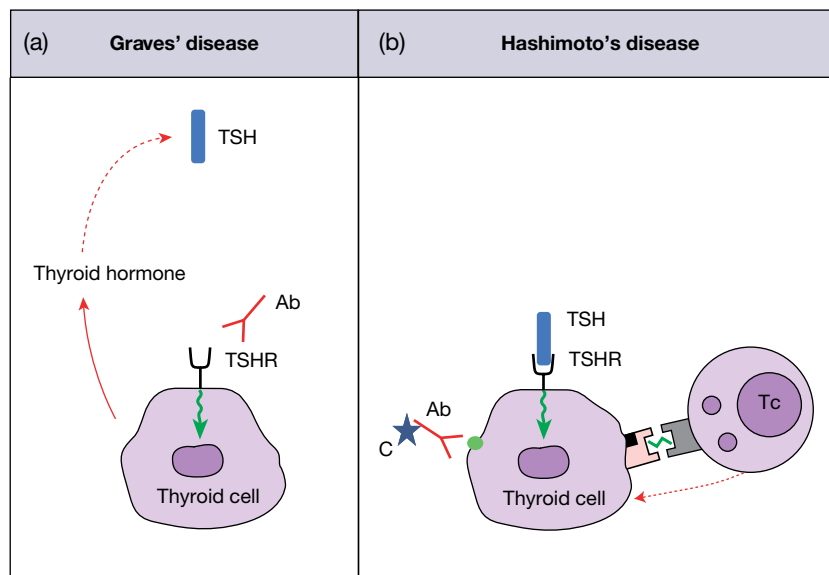


Figure 17.14 Thyroid autoimmune diseases. The two major types of thyroid autoimmune disease are illustrated. (a) In Graves' disease autoantibodies bind to the thyroid-stimulating hormone receptor (TSHR) on thyroid epithelial cells. These antibodies act as agonists and mimic the effect of TSH. The autoantibodies are continuously produced from plasma cells and therefore their production is not directly affected by the levels of thyroid hormone, unlike the levels of TSH that are subject to a negative feedback loop and therefore decrease when adequate levels of thyroid hormone are produced. Constant activation of the thyroid cells by the stimulatory autoantibody results in hyperthyroidism. (b) The autoantibodies in Hashimoto's disease are predominantly directed against thyroid peroxidase and thyroglobulin. The thyroid cells can be attacked by cytotoxic T-cells recognizing peptides derived from these autoantigens and/or by complement-fixing antibodies directed to intact autoantigen. Although TSH is able to bind to the TSH receptor and stimulate the thyroid cells the destruction of the thyroid by the autoimmune attack results in hypothyroidism.

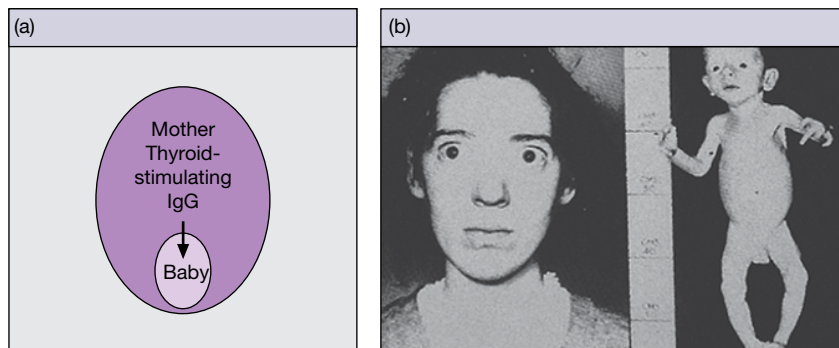


Figure 17.15 Neonatal thyrotoxicosis. (a) The autoantibodies that stimulate the thyroid through the TSH receptors are IgG and cross the placenta. (b) The thyrotoxic mother therefore gives birth to a baby with thyroid hyperactivity that spontaneously resolves as the mother's IgG is catabolized. (Source: A. MacGregor. Reproduced with permission.)

Stomach

The underlying histopathological lesion of the autoimmune gastritis associated with *pernicious anemia* is a chronic inflammatory mononuclear invasion leading to the destruction of gastric parietal cells. This in turn leads to the loss of the vitamin B₁₂-binding protein intrinsic factor and therefore anemia – vitamin B₁₂ being required for the efficient production of erythrocytes. The development of achlorhydria is almost certainly accelerated by the inhibitory action of antibodies to the gastric proton

pump, a cell surface H⁺/K⁺-dependent ATPase. About 70% of patients also have blocking autoantibodies to intrinsic factor.

Other tissues

Gut

The normally acquired tolerance to dietary proteins seems to break down in *celiac disease* where autoantibodies to the enzyme transglutaminase 2 (TG2) and T-cell sensitivity to the

gliadin component of wheat gluten in the small intestine can be demonstrated. Because gluten can bind to TG2, the uptake of the complex by IgA B-cells specific for this enzyme might “piggy-back” the gluten into the B-cell for processing and presentation on MHC class II to gliadin-specific T-helpers (see Figure 17.8). Stimulation of the B-cell would now follow with secretion of the IgA anti-TG2 autoantibodies.

Skin

An antibody pathogenesis for *pemphigus vulgaris* is favored by the correlation between disease severity and the titer of autoantibodies against desmoglein 3 (a member of the cadherin family of Ca^{2+} -dependent adhesion molecules) present at the cell–cell junctions of squamous epithelial cells. Likewise, antibodies to desmoglein 1 are thought to mediate the blistering of the epidermis in *pemphigus foliaceus*.

Sperm

In some *infertile males*, agglutinating autoantibodies cause aggregation of the spermatozoa and interfere with their penetration into the cervical mucus.

Glomerular basement membrane

Injection of cross-reacting heterologous glomerular basement membrane (GBM) preparations in complete Freund’s adjuvant produces glomerulonephritis in sheep and other experimental animals. Antibodies to GBM can be picked up by immunofluorescent staining with anti-IgG of biopsies from nephritic animals. The antibodies are largely, if not completely, absorbed out by the kidney *in vivo* and can passively transfer the disease to another animal of the same species.

An entirely analogous situation occurs in humans in certain cases of glomerulonephritis, particularly those associated with lung hemorrhage (*Goodpasture’s syndrome*). Kidney biopsy from the patient shows linear deposition of IgG and C3 along the basement membrane of the glomerular capillaries (see Figure 14.19a). Lerner and his colleagues eluted the GBM antibody from a diseased kidney and injected it into a squirrel monkey. The antibody rapidly fixed to the GBM of the recipient animal and produced a fatal nephritis. It is hard to escape the conclusion that the lesion in the human was the direct result of attack on the GBM by these complement-fixing antibodies. The lung changes in Goodpasture’s syndrome are attributable to cross-reaction with some of the GBM antibodies.

Heart

Neonatal lupus erythematosus is the most common cause of permanent *congenital complete heart block*. Almost all cases have been associated with high maternal titers of anti-La/SS-B or anti-Ro/SS-A. The key observation was that anti-Ro bound to neonatal rather than adult cardiac tissue and altered the transmembrane action potential by inhibiting repolarization.

IgG anti-Ro reaches the fetal circulation by transplacental passage but, although maternal and fetal hearts are exposed to the autoantibody, except in fairly rare cases only the latter is affected – presumably reflecting antigenic or structural differences between the adult and fetal heart. Anti-La also binds to affected fetal hearts reacting with laminin in the basement membrane.

Pathogenic effects of complexes with autoantigens

Systemic lupus erythematosus

Where autoantibodies are formed against soluble components to which they have continual access, complexes are formed that can give rise to type III hypersensitivity reactions, especially when defects in the early classical complement components prevent effective clearance. Thus, although homozygous complement deficiency is a rare cause of SLE, the archetypal immune complex disorder, it represents the most powerful disease susceptibility genotype so far identified; more than 80% of cases with homozygous C1q and C4 deficiency have SLE. Up to one-half of the patients carry autoantibodies to the collagenous portion of C1q, but in truth there are a rich variety of different autoantigens in lupus (see Table 17.2), some of them constituents of the nucleosome (see Figure 17.1b), with the most characteristic being *double-stranded DNA* (dsDNA). Anti-dsDNA is enriched in cryoglobulins and acid eluates of renal tissue from patients with lupus nephritis where it can be identified, in complexes containing complement, by immunofluorescent staining of kidney biopsies from patients with evidence of renal dysfunction. The staining pattern with a fluorescent anti-IgG or anti-C3 is punctate or “lumpy-bumpy” as once described (see Figure 14.19b), in marked contrast with the linear pattern caused by the GBM antibodies in Goodpasture’s syndrome (Figure 14.19a). The complexes grow in size to become large aggregates visible in the electron microscope as amorphous humps on both sides of the GBM. During the active phase of the disease, serum complement levels fall as components are affected by immune aggregates in the kidney and circulation. Deposition of complexes is widespread as the name implies, with 98% of patients developing lesions in the skin and/or joints/muscle, 64% in lung, 60% in blood and/or brain, 40% in kidney, and 20% in heart.

DNA itself is not a thymus-dependent antigen and the SLE autoantibodies include a cluster directed to the physically linked antigens constituting the nucleosome; one might envisage a “piggy-back” mechanism of the type portrayed in Figure 17.8. Knowing that nucleosome “blebs” appear that contain fragments of chromatin (DNA plus histones) on the surface of apoptotic cells and that a spontaneous expansion of nucleosome-specific T-cell populations precedes the clinical onset of SLE, a likely scenario is as follows. Nucleosome material is captured on the surface receptors of anti-DNA B-cells and internalized, followed by presentation of processed histone

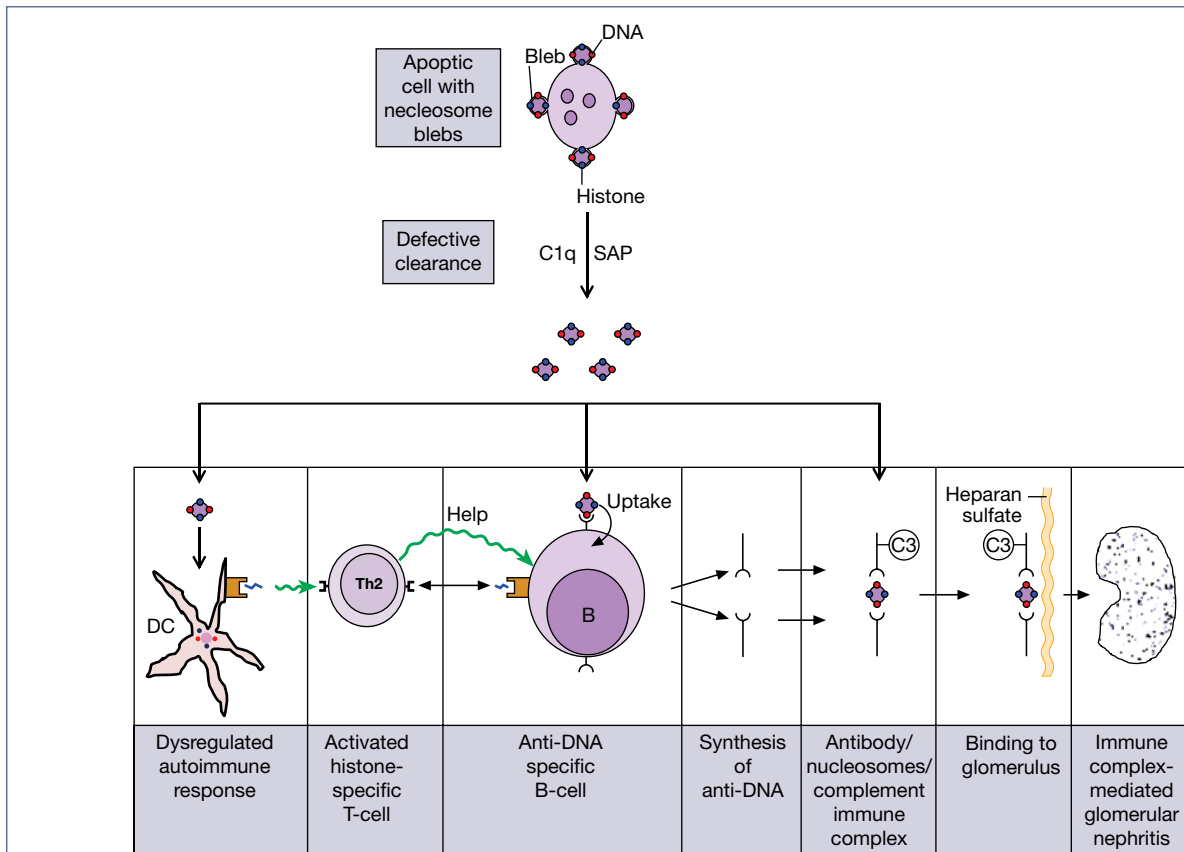


Figure 17.16 Conceivable pathogenetic pathway leading to end-organ damage in SLE. Nucleosomes derived from apoptotic cells can stimulate anti-DNA production by a “piggy-back” mechanism in susceptible hosts. The resulting complexes bind to heparan sulfate in the glomerular basement membrane where they induce glomerulonephritis. The high incidence of lupus in C1q-deficient individuals and the susceptibility of lupus patients to skin rashes on exposure to UV in sunlight, which induces apoptosis in skin cells, are well known. DC, dendritic cell; SAP, serum amyloid precursor.

peptide–MHC class II complex to the histone-specific T-helper cells, and clonal proliferation of DNA antibody-forming cells (Figure 17.16). Complexes of anti-DNA with circulating nucleosome material are demonstrable, and these will bind through the histone to extracellular heparan sulfate, where they can accumulate and damage end-organ targets such as the kidney glomerulus.

Rheumatoid arthritis

Morphological evidence for immunological activity

The joint changes in RA are produced by the dysregulated and invasive growth of the synovial cells developing into what is referred to as a *pannus* that overlays and destroys cartilage and bone (Figure 17.17). The synovial membrane that surrounds and maintains the joint space is invaded by large numbers of T-cells, mostly CD4, in various stages of activation, usually associated with dendritic cells and macrophages (Figure 17.17d); plasma cells are frequently observed (Figure 17.17e) and sometimes even secondary follicles with germinal centers are present.

There is widespread expression of surface HLA-DR (class II); T- and B-cells, dendritic, and synovial lining cells and macrophages are all positive, indicative of some pretty lively action. This fiery immunological reactivity provides an intense stimulus to the synovial lining cells that transform into the invasive pannus, thereby bringing about joint erosion through the release of destructive mediators. Granulomatous rheumatoid nodules may also develop (Figure 17.17f, g).

IgG autosensitization and immune complex formation

Autoantibodies to the IgG Fc region (Figure 17.18a), known as *rheumatoid factors*, are a feature of the disease. The majority of patients with rheumatoid arthritis have IgG or IgM rheumatoid factors. We must take into account a strange and unique feature of IgG rheumatoid factors; because they are both antigen and antibody at the same time they are capable of *self-association* (Figure 17.18b). IgG aggregates can be detected in the synovial tissues and in the joint fluid where they give rise to typical acute inflammatory reactions. The percentage of Fc γ

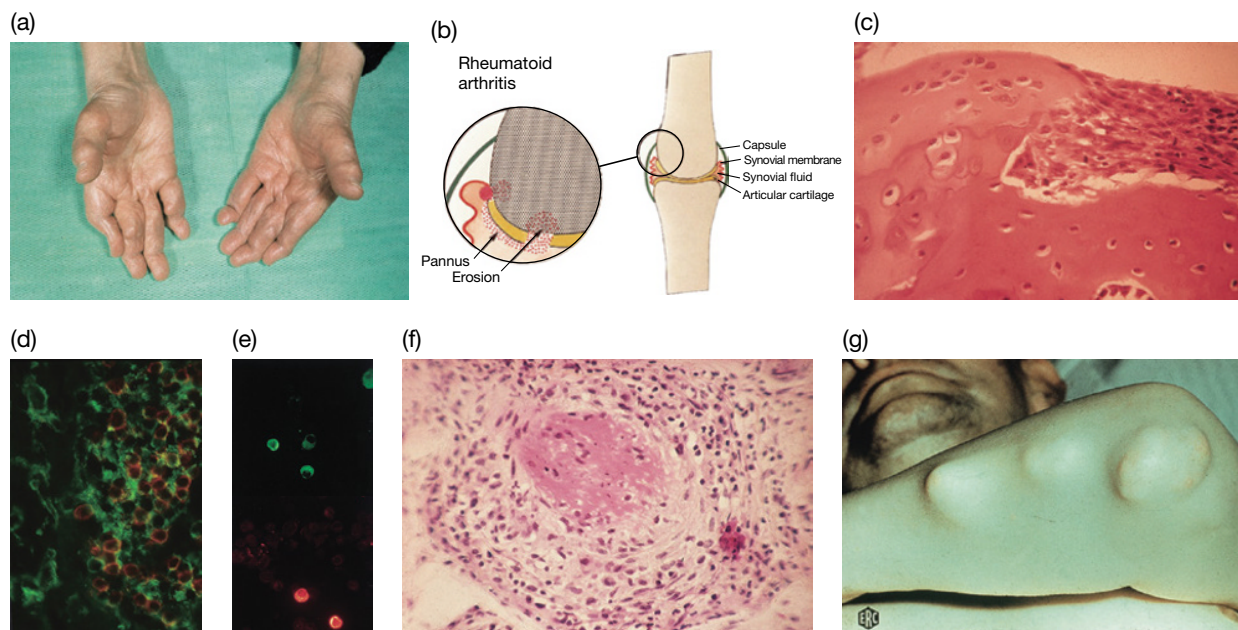


Figure 17.17 Rheumatoid arthritis (RA). (a) Hands of a patient with chronic RA. (b) Diagrammatic representation of a joint showing bone and cartilaginous erosions beneath the synovial membrane-derived pannus. (Source: D. Isenberg. Reproduced with permission.) (c) Histology of pannus showing clear erosion of bone and cartilage at the cellular margin. (Source: L.E. Glynn. Reproduced with permission.) (d) Rheumatoid synovium showing class II-positive antigen-presenting cells (green) in intimate contact with CD4⁺ T-cells (orange). (Source: G. Janossy. Reproduced with permission.) (e) Plasma cells isolated from a patient's synovial tissue stained simultaneously for IgM (with fluorescein-labeled F(ab')₂ anti-μ) and rheumatoid factor (with rhodamine-labeled aggregated Fcγ). Two of the four IgM-positive plasma cells appear to be synthesizing rheumatoid factors. (Source: P. Youinou and P. Lydyard. Reproduced with permission.) (f) Granulomatous appearance of the rheumatoid nodule with central necrotic area surrounded by epithelioid cells, macrophages, and scattered lymphocytes. Plasma cells making rheumatoid factor are often demonstrable and the lesion probably represents a response to the formation of insoluble anti-IgG complexes. (g) Large rheumatoid nodules on the forearm.

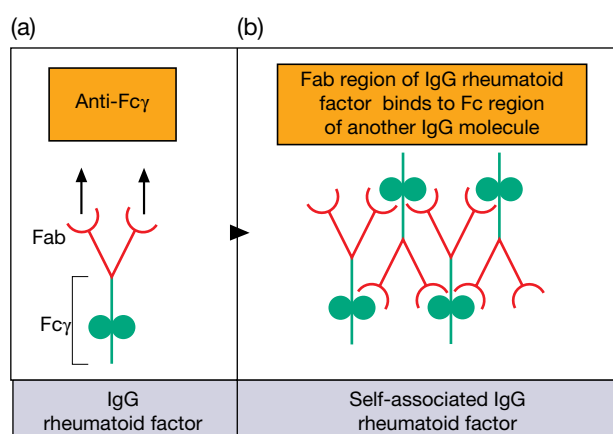


Figure 17.18 Self-associated complexes of IgG rheumatoid factor. (a,b) Although of relatively low affinity, the strength of binding is boosted by the “bonus effect” of the mutual attachment and, furthermore, such complexes in the joint may be stabilized by IgM rheumatoid factor (IgM anti-Fcγ) and C1q which have polyvalent binding sites for IgG.

sugars completely lacking galactose in the IgG of RA patients is nearly always higher than in the controls.

The production of tissue damage

As explained in the legend to Figure 17.18, the immune complexes can be stabilized by the multivalent Fcγ-binding molecules IgM rheumatoid factor and C1q, and when present in the joint space they may provoke an influx of neutrophils leading to the release of reactive oxygen intermediates (ROIs) and lysosomal enzymes. These include neutral proteases and collagenase that can **damage the articular cartilage** by breaking down proteoglycans and collagen fibrils. More damage results if the complexes are adherent to the cartilage, as the neutrophil binds but is unable to internalize them (“frustrated phagocytosis”); as a result, the lysosomal hydrolases are released extracellularly into the space between the cell and the cartilage.

The aggregates may also stimulate the macrophage-like cells of the synovial lining, either directly through their surface receptors or indirectly through phagocytosis and resistance to intracellular digestion. At this point we should acknowledge

that the release of cytokines such as TNF and GM-CSF from activated T-cells provides further potent macrophage stimulation. The activated synovial cells grow out as pannus over the cartilage and, at the margin of this advancing tissue, breakdown can be seen (Figure 17.17b,c), almost certainly as a result of the release of enzymes, ROIs and especially of IL-1 β , IL-6, and TNF. Activated macrophages also secrete plasminogen activator and the plasmin formed as a consequence activates a latent collagenase produced by synovial cells. The secreted products of the stimulated macrophage can influence chondrocytes (the cells that secrete and maintain the cartilage) to exacerbate **cartilage breakdown**, and osteoclasts to bring about **bone resorption** that is a further complication of severe disease.

T-cell-mediated hypersensitivity as a pathogenic factor in autoimmune disease

Arthritis again

In rheumatoid arthritis the chronically inflamed synovium is densely crowded with activated T-cells and their critical role in the disease process is emphasized by the beneficial effects of cyclosporine and anti-CD4 treatments. High levels of IL-15 within the synovial membrane can recruit and activate T-cells whose secretion of cytokines and ability to induce macrophage synthesis of TNF and further IL-15 drives pannus development with consequent erosion of cartilage and bone (Figure 17.17c).

The antigenic history of **reactive arthritis** is more amenable to study as it is triggered by an infection either of the urogenital tract by *Chlamydia trachomatis* or of the gastrointestinal tract with *Yersinia*, *Salmonella*, *Shigella*, or *Campylobacter*. All these microbes are either obligate or facultative intracellular bacteria and so may escape the immune system by hiding inside cells. However, we may be dealing with molecular mimicry. Natural infection of mice with *Salmonella typhimurium* generates CD8 cytotoxic T-cells that recognize an immunodominant epitope of the GroEL molecule presented by the class Ib Qa-1 and cross-react with a peptide from mouse hsp60, so permitting a reaction with stressed macrophages. In humans, HLA-B27 individuals are particularly at risk of developing reactive arthritis and the importance of the microbial component is emphasized by experiments on mice bearing an HLA-B27 transgene. If reared in a germ-free environment, lesions are restricted to the skin, but in the microbiological wilderness of the normal animal house, the skin, gut, and joints are all affected. Why, as in RA, are the joints targeted and what does B27 do? Only one in 300 of the T-cells in the reactive arthritis synovium is CD8 and therefore class I restricted. It could be that a cross-reactive B27 sequence functions as a cryptic epitope perpetuating a gentle microbial stimulus with an amplifying autoimmune response.

Another rheumatological condition closely associated with HLA-B27 is **ankylosing spondylitis (AS)**. Autoantibodies with

specificity for a range of connective and skeletal tissue proteins are present. The beneficial effects of anti-TNF therapy indicate an important role for this cytokine in disease pathogenesis. Despite the very strong class I association, studies in the HLA-B27 transgenic rat, a model for human AS, indicate the CD8⁺ cytotoxic T-cells do not play a role in disease pathogenesis. Rather, the tendency of HLA-B27 molecules to misfold in the endoplasmic reticulum, and subsequently dimerize, leads to an unfolded protein stress response resulting in excessive production of IL-23 by Th17 cells following pattern recognition receptor activation. Polymorphisms of the IL-23 receptor gene are associated with the development of AS in humans.

Organ-specific endocrine disease

Hashimoto's disease

The inflammatory infiltrate in Hashimoto's thyroiditis (see Figure M17.1.1c) represents a T-cell-mediated hypersensitivity. The demonstration of class II molecules on patients' thyroid epithelial cells and the presence of antigen-specific Th1 cells in the thyroid implicate the involvement of these cells. Destruction of the thyroid epithelial cells may involve engagement of Fas on their surface with subsequent induction of apoptosis.

We must turn to the animal models for further evidence, albeit indirect. Removal of T-cells in the Obese Strain (OS) chicken prevents the spontaneous development of thyroiditis and, at the target cell level, the threshold for induction of MHC class II on OS thyroid epithelial cells by IFN γ is far lower than that reported for normal thyroid cells, further reinforcing the notion that a thyroid abnormality is a contributory factor to the susceptibility phenotype. Another model, in which thyroiditis is induced by thyroglobulin in complete Freund's adjuvant (see Figure M17.1.1b), can be transferred to naive histocompatible recipients with CD4⁺ T-cell clones specific for peptides containing thyroxine.

Type 1 diabetes

Just as in autoimmune thyroiditis, type 1 diabetes involves chronic inflammatory infiltration and destruction of the specific tissue, in this case the insulin-producing β -cells of the pancreatic islets of Langerhans. *In vitro* T-cell responses to islet cell antigens, including glutamic acid decarboxylase (GAD), directly reflect the risk of progression to clinical diabetes. The strength of the risk factors associated with certain HLA-DQ alleles also has a strong whiff of T-cell action. Although CD8⁺ (presumably including cytotoxic) T-cells are the most abundant population in the inflammatory lesion, CD4⁺ T-cells, B-cells, plasma cells, and macrophages are also present, but there are very few Foxp3⁺ (regulatory) T-cells or NK cells.

To obtain further insight into the cellular siege and destruction of the islet β -cells, one has to look to the **nonobese diabetic (NOD) mouse** that spontaneously develops diabetic disease closely resembling human type 1 diabetes in its range of

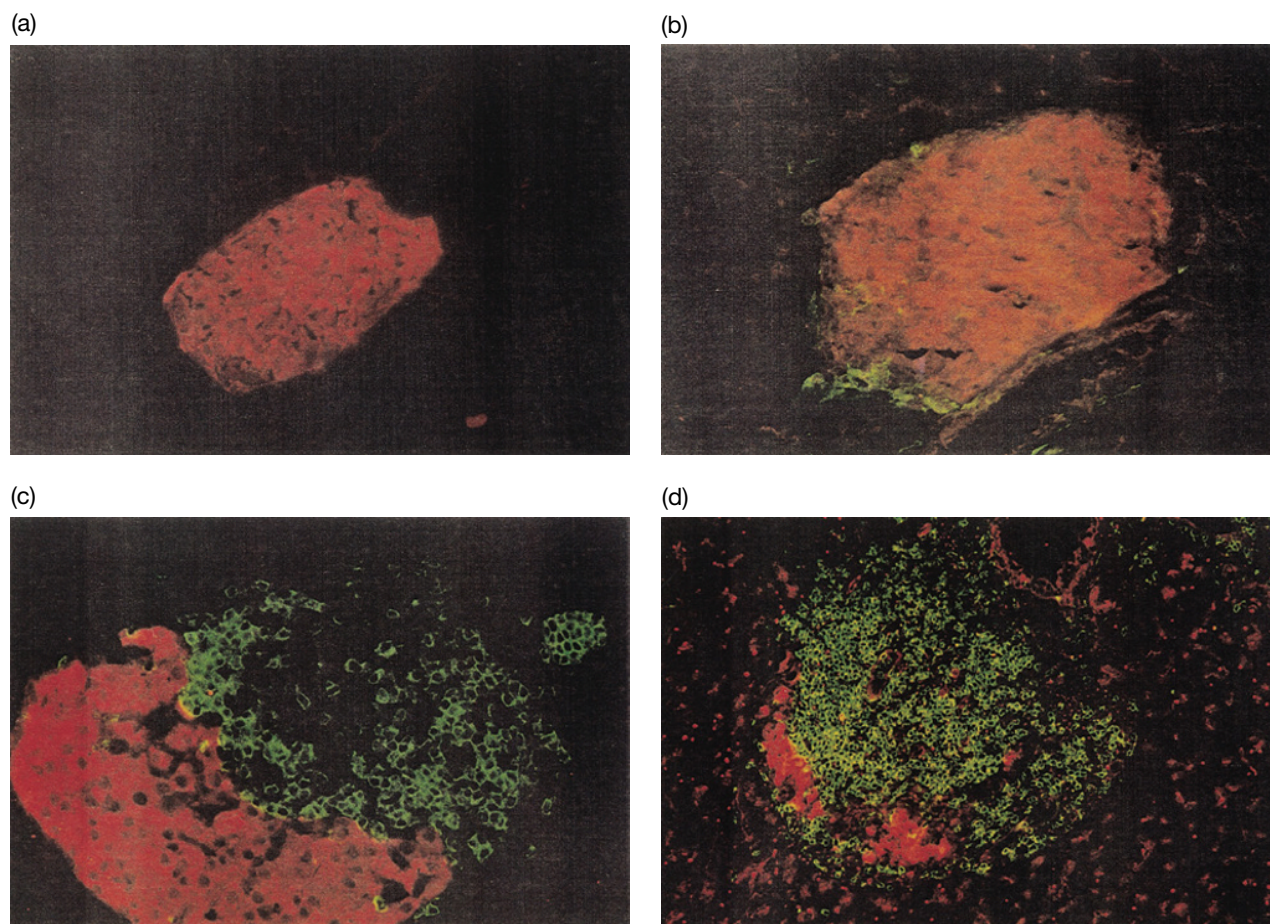


Figure 17.19 Destruction of pancreatic islet β -cells by infiltrating T-cells in the non-obese diabetic (NOD) mouse. (a) Normal intact islet. (b) Early peri-islet infiltration. (c) Penetration of the islet by infiltrating T-cells. (d) Almost complete destruction of insulin-producing cells with replacement by invading T-cells. Insulin stained by rhodamine-conjugated antibodies and T-cells by fluoresceinated anti-CD3. (Data source: Quartey-Papafio R. *et al.* (1995) *Journal of Immunology* **154**, 5567–5575. photographs by J. Phillips.)

autoimmune responses and the association of islet breakdown with a chronic infiltration by T-cells and macrophages (Figure 17.19). Many of the T-cells infiltrating the islets in diabetic mice have a Th1-type cytokine profile and can transfer disease to NOD recipients congenic for the severe combined immunodeficiency (SCID) mutation. However, increases in Th17-derived IL-21 resulting from NOD-associated polymorphisms in the binding site for the Sp1 transcription factor in the promoter region of the *IL-21* gene are also strongly implicated.

Up to 50% of the infiltrating T-cells isolated from pre-diabetic NOD islets are insulin specific and can transfer disease to young NOD mice. However, GAD-specific T-cells can also be recovered and these too are diabetogenic.

GAD in the central and peripheral nervous system produces γ -aminobutyric acid (GABA), a major inhibitory neurotransmitter, from glutamine. Autoantibodies to GAD are seen not only in type 1 diabetes, but also in *stiff man syndrome*, where the GABA-ergic pathways controlling motor neuron

activity are defective. The antibodies cannot be pathogenic because GAD is present on the inner surface of the plasma membrane, but T-cells could be. How the brain, as distinct from the pancreatic islet, could be specifically targeted is a conundrum, but 30% of patients do develop type 1 diabetes.

Multiple sclerosis (MS)

Human MS has a number of similarities to experimental autoimmune encephalomyelitis (EAE) in rodents, which is produced by immunization with myelin, usually myelin basic protein (MBP), in complete Freund's adjuvant, leading to motor paralysis. T-cell clones specific for MBP will transfer disease. In humans the serologically defined DR2 phenotype (which corresponds to the DRB1*15:01, DQA1*01:02, DQB1*06:02 haplotype) is strongly associated with susceptibility to MS. Furthermore, at least 37% of activated T-cells responsive to IL-2/IL-4 in cerebrospinal fluid are specific for myelin components, compared with a figure of 5% for subjects

with other neurological disturbances. The MS inflammatory lesions contain a number of different cell types including T-cells (particularly of the Th1 and Th17 variety), B-cells, NKT cells, and macrophages. Lymphocyte homing into the CNS is especially dependent on α_4 integrin binding to VCAM-1 expressed on the brain endothelium as evidenced by the established effectiveness of natalizumab (an anti- α_4 integrin monoclonal antibody) in the treatment of MS relapses. Clinical trials are also underway to assess the efficacy of the anti-IL-17A monoclonal antibody secukinumab.

Some other diseases with autoimmune activity

Attacks on the vasculature

The characteristic feature of *Wegener's granulomatosis* is a necrotizing granulomatous vasculitis associated with the presence of antineutrophil cytoplasmic antibodies (cANCA, Figure 17.20). Although these autoantibodies are directed to the intracellular protease III in the primary granules of the neutrophil, TNF priming of these cells causes translocation of the protease to the cell surface. The autoantibody then activates the cell, causing degranulation with the release of various proteolytic enzymes, and the generation of reactive oxygen intermediates (ROIs), which together damage the blood vessel endothelium, thereby accounting for the vasculitic lesions.

Giant cell arteritis (sometimes referred to as temporal arteritis because the temporal artery is often involved) is a vasculitis of large- and medium-sized arteries affecting around 1 in 500 individuals over the age of 50. Patients have an increased frequency of anti-ferritin autoantibodies and the disease gets its name from the presence of multinucleate giant cells which result from the fusion of macrophages. It is strongly associated

with HLA-DR4 and is exquisitely sensitive to high-dose steroids. The dendritic cells, macrophages, and CD4⁺ T-cells in the lesion are likely to be central to the pathogenesis. It is thought that putative autoantigens such as ferritin are presented by the dendritic cells to Th1 cells whose copious production of IFN γ leads the macrophages to secrete IL-1 β and IL-6. ROIs and matrix metalloproteases are also produced by the activated macrophages, resulting in vessel damage. In addition, IFN γ stimulates the giant cells to produce vascular endothelial growth factor (VEGF) that promotes the growth of capillaries, and the interferon also causes both giant cells and conventional macrophages to secrete platelet-derived growth factor (PDGF), leading to proliferation of the intimal cells that form the inner lining of the blood vessels.

Scleroderma is divided into a number of subgroups, including localized scleroderma (morphea), limited cutaneous systemic sclerosis, diffuse cutaneous systemic sclerosis, and systemic sclerosis sine scleroderma in which internal organs are affected without skin involvement. There is increased deposition of collagen and other matrix components, causing extensive fibrosis of the skin and internal organs centered around small arteries and microvasculature, eventually producing capillary occlusion. The pathogenesis is poorly understood, but the presence of antinuclear antibodies (ANA), including those directed against centromere, topoisomerase-1 (Scl-70), and RNA polymerase III in the vast majority of patients with the systemic sclerosis variants, suggests some major intrusion by autoimmune elements. Patients with localized scleroderma may also possess ANA but against different nuclear components such as histones. The lesions in scleroderma are infiltrated by T- and B-cells, macrophages, and mast cells. The T-cells include those of the Th1, Th2, and Th17 phenotypes. There is upregulation of adhesion molecules such as VCAM-1, ICAM-1, and E-selectin and extensive production of a variety of proinflammatory cytokines and chemokines, which recruit and activate fibroblasts and myofibroblasts, contributing to the development of the fibrosis.

Atherosclerotic plaques are focal lesions in large elastic and muscular arteries. The plaques cause intimal thickening and are composed of a subendothelial fibrous cap of collagen and matrix-rich connective tissue, foam cells (lipid-filled macrophages), and proliferating smooth muscle cells. Rupture of a plaque leads to thrombosis. CD4⁺ T-cells (mostly of the Th1 phenotype), CD8⁺ T-cells, B-cells, macrophages, dendritic cells, mast cells, and neutrophils are all present in the lesion. This has led to the idea that atherosclerosis may be an autoimmune disease. The lead candidate autoantigens are low-density lipoprotein (LDL), heat-shock protein (hsp), and β_2 -glycoprotein-1. Macrophage scavenger receptors take up oxidized LDL, including the highly proinflammatory adducts malondialdehyde and 4-hydroxynonenal aldehyde, and may then present these autoantigens to the T-cells. Furthermore, immune complexes that contain IgG, oxidized LDL, and β_2 -glycoprotein-1 are thought to be pro-atherogenic. Also of note is that immunization with mycobacterial hsp65 elicits atherosclerotic lesions at

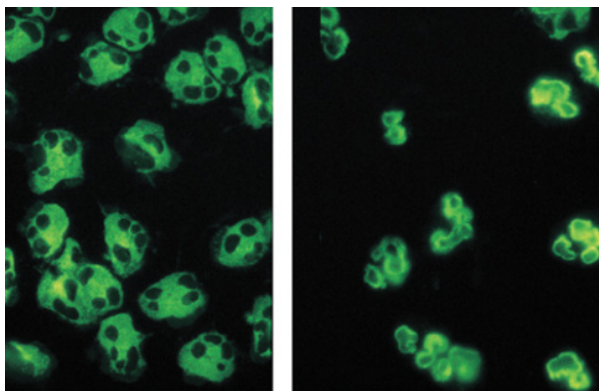


Figure 17.20 Antineutrophil cytoplasmic antibodies (ANCA).

Left: Cytoplasmic cANCA diffuse staining specific for protease III in Wegener's granulomatosis. Right: Perinuclear p-ANCA staining by myeloperoxidase antibodies in periarteritis nodosa. Fixed neutrophils are treated first with patient's serum then fluorescein-conjugated anti-human Ig. (Source: G. Cambridge. Reproduced with permission.)

sites subject to major hemodynamic stress, and a cholesterol-rich diet makes them worse. Antibodies and Th1 cells are produced that react with human hps60 owing to its substantial sequence homology with mycobacterial hsp65. With a prevalence of 1.7% in the United States, atherosclerosis would rank as almost the most common autoimmune disease if it were to be generally accepted as such.

Autoimmunity affecting the skin

We have already mentioned quite a few autoimmune diseases with skin involvement, including the fibrosis seen in scleroderma and the characteristic butterfly rash in systemic lupus erythematosus. Pretibial myxedema is seen in some patients with Graves' disease, and skin blistering occurs in both pemphigus vulgaris and pemphigus foliaceus. The evidence that these various conditions represent autoimmune diseases is pretty strong. However, there are other diseases affecting skin that may also turn out to be autoimmune. For example, although it is currently unclear whether the chronic inflammation in *psoriasis*, a condition affecting around 2% of the population, is driven by an infectious agent, by autoantigen, or by a response to stressed or damaged cells, the fact that it is mediated by activated T-cells present in the psoriatic plaques seems beyond doubt. One hypothesis is that T-cells specific for streptococcus may cross-react with keratin. The response is driven by dendritic cells which secrete substantial amounts of IL-12 and IL-23. The therapeutic effectiveness of antagonists against IL-23 or IL-17A only serves to reinforce the immunological contribution to this disease. If an autoimmune pathology is confirmed, then psoriasis will go straight to the top of the "hit parade" in Table 17.2. Th1, Th17, and Th22 cells are all present, as well as CD8⁺ T-cells and $\gamma\delta$ T-cells. IL-22 is known to be a potent inducer of keratinocyte proliferation.

An autoimmune component is also implicated in the skin depigmentation seen in *vitiligo*. This disease, it should be pointed out, has an increased incidence in patients with known autoimmune disorders, particularly Graves' disease. Autoreactive melanocyte-specific CD8⁺ T-cells are thought to destroy the melanocytes, and antibodies against melanocytes are also present. Expression of the CXCL10 chemokine is increased in patient skin, and its receptor CXCR3 is present on the putative pathogenic T-cells. Of particular interest is the discovery that a neutralizing antibody against the CXCL10 chemokine resulted in repigmentation in an animal model of vitiligo, opening up a potential therapeutic target.

Measurement of autoantibodies

Serum autoantibodies frequently provide valuable diagnostic markers. Screening of the serum can be carried out by indirect immunofluorescence on frozen tissue sections (see Figure 17.1). Agglutination tests are available for rheumatoid factors and for thyroglobulin, thyroid peroxidase, and red blood cell antibodies, as well as ELISAs for antibodies to intrinsic factor,

DNA, IgG, extractable nuclear antigens, and so on. Automated analyzers based on, for example, purified gene-cloned antigens in minispot array ELISAs or in multiplexed addressable laser bead assays (ALBAs) are taking over and beginning to supplant the need for immunofluorescence, which is time-consuming and more skilled.

Autoantibody detection tests will also prove of value in screening for people at risk, for example in relatives of patients with autoimmune diseases such as type 1 diabetes where antibodies against GAD, IA2, and insulin are predictive of future disease onset (particularly if all three antibodies are present). Unfortunately, quite what one does to prevent the disease arising in the autoantibody-positive relatives is, at this point in time, not entirely clear.

Therapeutic options

Organ-specific autoimmunity

The majority of approaches to treatment, not unnaturally, involve manipulation of immunological responses (Figure 17.21). However, in many organ-specific diseases, metabolic control is usually sufficient (e.g., thyroxine replacement in Hashimoto's disease, insulin in type 1 diabetes, vitamin B12 in pernicious anemia). In Graves' disease, antithyroid drugs that block the action of the thyroid peroxidase required for the production of thyroid hormone can be given, or alternatively the thyroid ablated with ¹³¹I or the surgical approach of subtotal thyroidectomy used. Anticholinesterase drugs are commonly used for long-term therapy in myasthenia gravis, and thymectomy is also an option with well-established efficacy. Transplantation of pancreatic islets can be used for type 1 diabetics albeit with all the problems associated with any graft (i.e., shortage of donors, the need to match HLA, and the requirement for potentially harmful immunosuppressive drugs). Encapsulation of the islets to prevent allograft rejection is one approach that is being actively explored.

Based on the possibility that MS is virally driven, patients were treated with IFN β ; relapse rates were reduced by a third in relapsing–remitting disease and this has become a standard treatment for this form of the disease. However, there is only a modest effect on progressive disease. It is likely that IFN β is not acting primarily as an antiviral in MS, but rather exhibiting anti-inflammatory and immunomodulatory activities via multiple actions on T-cells. Natalizumab, a humanized monoclonal antibody against the α_4 -integrin, can reduce the number of relapses by two-thirds although it carries the risk of triggering progressive multifocal leukoencephalopathy, a condition that actually exacerbates myelin breakdown. It is therefore used cautiously.

Disease-modifying anti-rheumatic drugs

Nonsteroidal anti-inflammatory drugs (NSAIDs) are effective in reducing inflammation in rheumatological conditions but have little effect on disease progression. Patients with RA

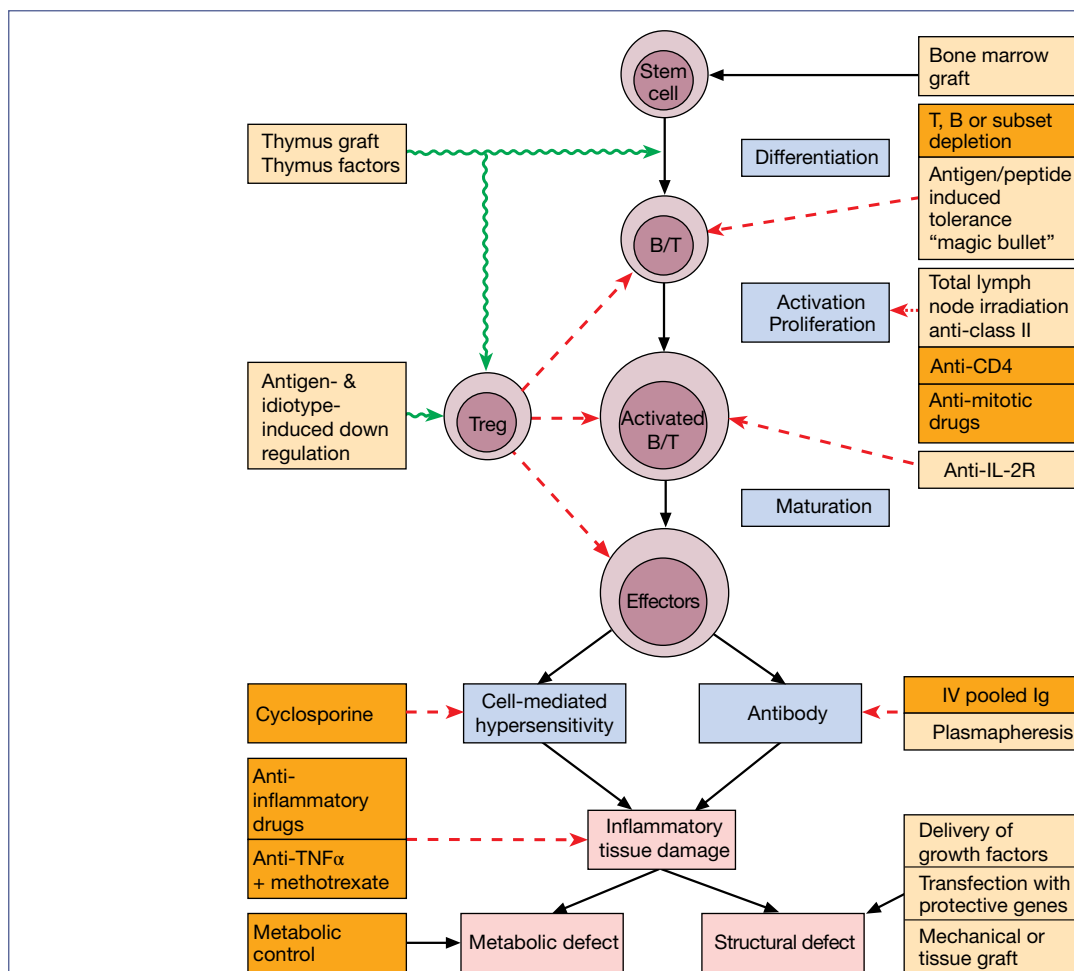


Figure 17.21 The treatment of autoimmune disease. Current conventional treatments are in dark orange; some feasible approaches are given in lighter orange boxes. (In the case of a live graft, bottom right, the immunosuppressive therapy used may protect the tissue from the autoimmune damage that affected the organ being replaced.)

and with many other autoimmune diseases respond well to high doses of steroids but there are significant adverse side-effects associated with long-term use. Disease-modifying anti-rheumatic drugs (DMARDs), such as methotrexate (MTX), sulfasalazine, gold salts, and leflunomide, can be effective. For example, the active metabolite of leflunomide inhibits *de novo* rUMP synthesis, thereby leading to G1 arrest of cycling lymphocytes.

A major advance in therapy came with the finding that neutralizing TNF with a monoclonal antibody is highly effective, so revealing the pathogenetic role of this cytokine. Following this observation a number of anti-TNF agents have been approved for use in RA, including infliximab, a mouse-human chimeric monoclonal anti-TNF, adalimumab, a human monoclonal anti-TNF, and etanercept, a fusion protein of the extracellular ligand binding region of the TNF receptor and the Fc γ portion of IgG. Anti-TNFs can be used effectively in combination with methotrexate.

Antimitotic drugs

Conventional nonspecific antimitotic agents such as azathioprine, cyclophosphamide, and methotrexate, usually in combination with steroids, have been used effectively in SLE, RA, chronic active hepatitis, and autoimmune hemolytic anemia, for example.

In a sense, because it blocks cytokine secretion by T-cells, cyclosporine is an anti-inflammatory drug and, as cytokines such as IL-2 are also obligatory for lymphocyte proliferation, cyclosporine is also an antimitotic drug. It is of proven efficacy in uveitis, early type 1 diabetes, nephrotic syndrome, and psoriasis and of moderate efficacy in idiopathic thrombocytopenic purpura, SLE, polymyositis, primary biliary cirrhosis, and myasthenia gravis.

High-dose IV cyclophosphamide plus adrenocorticotrophic hormone (ACTH) or total lymph node irradiation through its effect on the peripheral immune system either slowed or

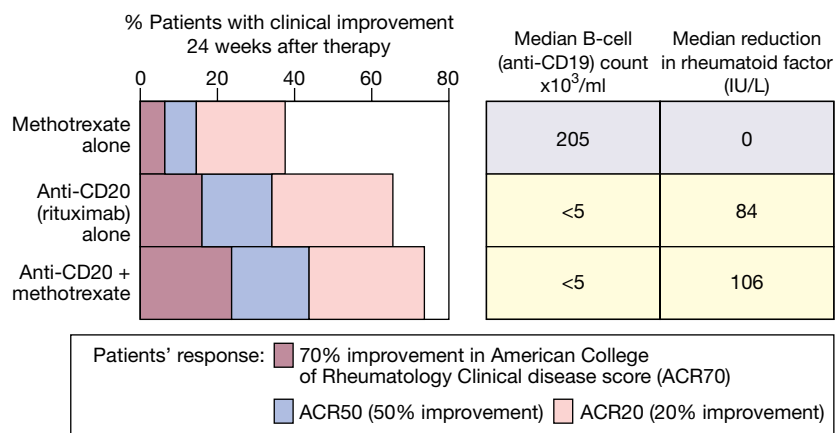


Figure 17.22 B-cell depletion therapy in patients with active rheumatoid arthritis. Rituximab, a humanized monoclonal antibody specific for B-cell CD20, can act in combination with the antimetabolic agents cyclophosphamide or methotrexate to produce marked amelioration of disease. (Data source: Edwards J.C.W. *et al.* (2004) *New England Journal of Medicine* **350**, 2572–2581.)

stopped the advance of disease in approximately two-thirds of progressive MS patients for 1–2 years, a strong indication that the disease is mediated by immune mechanisms. This is further supported by the unfortunate finding that IFN γ exacerbates disease in the majority of patients.

Immunological control strategies

Cellular manipulation

It should one day be practical to correct any relevant defects in stem cells or in thymus processing by gene therapy, bone marrow or thymus grafting, or perhaps, in the latter case, by thymic hormones. Many centers are carrying out autologous stem cell transplantation following hemato-immunoablation by cytotoxic drugs in severe cases of autoimmune disease in an attempt the “reset” the immune response. Overall, over one-third of difficult cases of SLE, scleroderma, juvenile and adult RA, and so on achieve drug-free remission. Transplant-related mortality is around 5%, comparable to that seen with cancer patients.

Because T-cell signaling is so pivotal, it is the target for many strategies. Injection of monoclonal anti-MHC class II and anti-CD4 successfully fends off lupus in spontaneous mouse models. Some take the anti-IL-2 receptor approach to deplete activated T-cells, but we would like to refer back to our discussion of the long-lasting effect of nondepleting anti-CD4 for the induction of tolerance (Figure 15.13), particularly when reinforced by repeated exposure to antigen. Antigen reinforcement of course is an obvious continuing feature in autoimmune disease, so that anti-CD4 should be ideal as a therapy in disorders where the natural “switch-off” tolerogenic signals are still accepted by the CD4 cells. Abatacept, which has gained regulatory approval for use in RA, is a fusion protein of the extracellular domain of CTLA-4 with Fc γ . Its binding to CD80 and CD86 blocks the action of these co-stimulatory molecules, leading to T-cell anergy.

Pulsing relapsing–remitting MS patients with alemtuzumab (Campath-1H, a humanized anti-CD52), produced a brutal and surprisingly persistent reduction in T-cell numbers, with around 80% of patients having no relapses in 3 years post treatment. This result compares with about 50% who received IFN β . One has to balance this improvement against the side-effects of alemtuzumab treatment, which include precipitation of the development of pancytopenia, idiopathic thrombocytopenia, or autoimmune haemolytic anemia in some patients.

Now, if one takes the view that rheumatoid factor immune complexes are major players in the pathogenesis of the RA joint lesions, logic suggests the radical approach of B-cell ablation with rituximab, a mouse–human chimeric monoclonal anti-CD20, as used in the treatment of B-cell leukemia. B-cells may play a role as antigen-presenting cells for T-cell activation, and are, of course, also the source of the antibodies to citrullinated peptides/proteins that are so characteristically associated with RA. Successful clinical trials have led to the licensing of rituximab for use, in combination with methotrexate, in RA patients who fail to respond adequately to anti-TNF treatment (Figure 17.22). There looks to be a good future for similar therapy in other autoimmune diseases where B-cells are implicated, such as SLE.

Manipulation of regulatory mediators

Some spontaneous models of autoimmune disease can be corrected by injection of cytokines: IL-1 β cures the diabetes of NOD mice; TNF prevents the onset of SLE symptoms in NZB \times W hybrids; and transforming growth factor- β 1 (TGF β 1) is known to protect against collagen arthritis and relapsing EAE. Cytokine action can be blocked using specific monoclonals, soluble versions of receptors, or natural antagonists. We have already discussed the use of anti-TNFs. Other biologics targeting regulatory mediators that have been approved for the treatment of RA include anakinra, a recombinant nonglycosylated IL-1 β

receptor antagonist, and tocilizumab, a humanized anti-IL-6 receptor. Monoclonal antibodies against IL-15, IL-17, and the shared p40 subunit of IL-12/IL-23 are also being investigated for efficacy in RA, as are small molecule inhibitors of the p38, JAK3, and syk signal transduction kinases involved in lymphocyte activation.

Pooled normal immunoglobulin

Intravenous injection of Ig pooled from several thousand normal donors has long been used for the treatment of patients with immunodeficiencies affecting B-cells. However, in the 1980s it was discovered that it also frequently has a beneficial effect in a number of autoimmune diseases. These include a variety of neuromuscular disorders (e.g., myasthenia gravis), hematologic diseases (e.g., autoimmune haemolytic anemia), and dermatologic conditions (e.g., pemphigus vulgaris). Several mechanisms have been proposed to explain these remarkable effects but they remain rather speculative. The inhibitory effects of F(ab')₂ fractions in patients with autoantibodies to procoagulant factor VIII suggest a possible role for anti-idiotypic reactions. However, in an animal model of RA (involving injection of arthritis-inducing serum from K/B × N transgenic mice into C57Bl/6 mice), administration of either biochemically produced or recombinant Fc γ possessing 2,6-sialylated glycans reduced inflammation, possibly owing to enhanced expression of the inhibitory Fc γ RIIb.

Re-establishing immunological tolerance

The object is to present the offending antigen in a concentration and in a form that will turn off an ongoing autoimmune response (i.e., induce specific immunological tolerance). This is the “holy grail” for the treatment of autoimmune disease as it attempts to deal with the underlying problem (i.e., the breakdown of specific immunological tolerance) rather than being the damage limitation exercise that underlies most current therapies. As T-cells have been accorded such a pivotal role, it is natural to devise the strategy in terms of T-cell epitopes rather than whole antigen, obviously a far more practical proposition because this reduces the problem to dealing with relatively short peptides. To date, however, attempts at re-imposing immunological tolerance have met with very little success in clinical trials.

One strategy has been to design high-affinity peptide analogs (altered peptide ligands) that will bind obstinately to the appropriate MHC molecule and antagonize the response to autoantigen. As we express several different MHC molecules, this should not impair microbial defenses unduly. However, we are now talking of patients not mice and this could involve repeated very high doses of peptide, although, much in their favor, peptides are well-defined chemically and relatively cheap to produce. Antigen-specific suppression of T-cells would be advantageous in this respect, and giving the peptide under an umbrella of anti-CD4 or using partial agonists that bind MHC but are not recognized by the TCR could be feasible. Injection

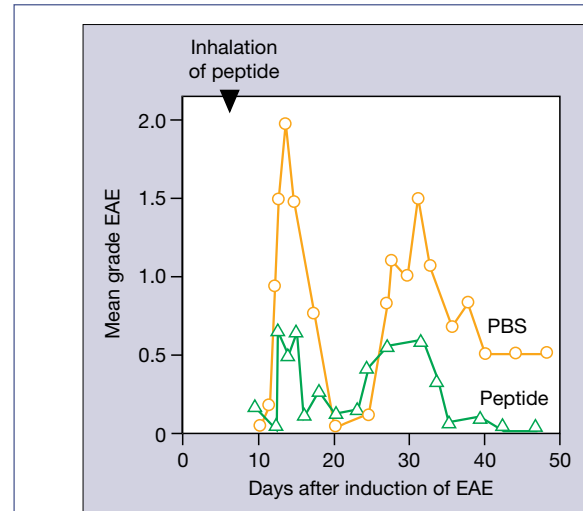


Figure 17.23 Influence of peptide inhalation on experimental autoimmune encephalomyelitis (EAE) induced with pig spinal cord in complete Freund's adjuvant. Aerosols of the peptide were inhaled 8 days after injection of the encephalitogen. A single dose can give long-lived protection that is extended indefinitely if the mice are thymectomized. Regulation is IL-10 dependent and both Th1 and Th2 can be tolerized. Administration of a single peptide T-cell epitope can induce tolerance to other autoantigenic epitopes on the same protein (linked suppression) and to epitopes on different antigens within the nervous tissue used for immunization (bystander tolerance). PBS, phosphate-buffered saline; the peptide was an acetylated N-terminal 11-mer from myelin basic protein with lysine at position 4 substituted by alanine. (Data source: Metzler B. and Wraith D.C. (1996) *Annals of the New York Academy of Science* **778**, 228–242.)

of an MBP peptide, particularly as a palmitoylated derivative inserted in liposomes, can block EAE and an hsp60 peptide can prevent the onset of diabetes in the NOD mouse.

We have already noted that, because the mucosal surface of the gut is exposed to a horde of powerfully immunogenic microorganisms, and as enterocytes are especially vulnerable to damage by IFN γ and TNF, it has been important for the immune defenses of the gut to evolve mechanisms that deter Th1-type responses. This objective is attained by the stimulation of regulatory cells that release cytokines such as TGF β and IL-10 and suppress the unwanted responses. Thus feeding antigens should tolerize Th1 cells and this has proved to be a successful strategy for blocking EAE, as well as the type II collagen arthritis model and the development of diabetes in NOD mice. The tolerogen can also be delivered by inhalation of peptide aerosols (Figure 17.23), and this could be a very attractive way of generating antigen-specific T-cell suppression in many hypersensitivity states. Induction of anergy or active suppression may contribute to different extents. Intranasal peptides have been used successfully to block collagen-induced arthritis, EAE, and the spontaneous diabetes (NOD) mouse models. Significantly, treatment can be effective even *after* induction of

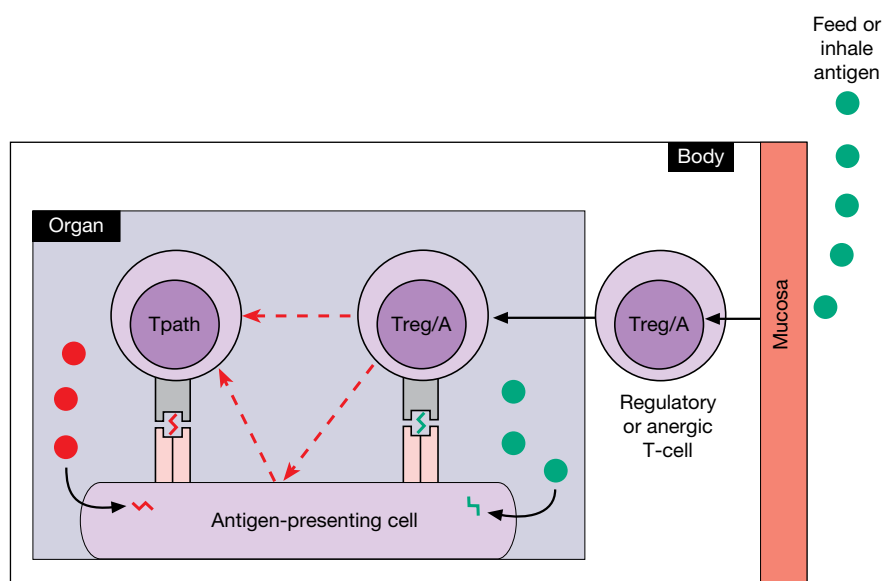


Figure 17.24 Organ-related bystander tolerance induced by feeding or inhaling an organ-related autoantigen. Induced regulatory or anergic tolerogen-specific T-cells (Treg/A) enter the organ and inhibit pathogenic T-cells (Tpath) on the same antigen-presenting cell that processes both the tolerogen and the other organ-derived antigen recognized by the pathogenic cell. Regulators act by production of IL-10 and TGF β , that downregulate the Th1 cells either directly or through an intermediate effect on the antigen-presenting cell.

disease (Figure 17.23), although in established human disease this may be more difficult to achieve and might require supplementary therapy, such as anti-CD4, and preliminary reduction of primed T-cells with cyclosporine or steroids.

A further strategy being employed for type 1 diabetes is using DNA vaccination into muscle with the gene for proinsulin in order to deliver autoantigen in the absence of danger signals.

Now this is really important. A single internal epitope of MBP can inhibit disease induced by the *mixture* of epitopes or antigens contained within whole myelin. In other words,

a single epitope can induce suppression of the pathogenic T-cells specific for other epitopes on the same or other molecules provided that they are generated within the same organ or locality. We have referred to this already as *organ-related bystander tolerance*, a phenomenon best understood in terms of interactions on the same antigen-presenting cell between the regulatory cell or anergic T-cell, recognizing the suppressor epitope and the pathogenic Th1 cell recognizing a *separate epitope* processed from the same or another molecule in the same organ (Figure 17.24).

SUMMARY

- The immune system balances precariously between effective responses to environmental pathogens and regulatory control of an array of potentially suicidal responses to self molecules.

The range of autoimmune diseases

- Five to eight percent of individuals develop autoimmune disease.
- In **organ-specific** autoimmune disease, exemplified by Hashimoto's thyroiditis, Graves' disease and type 1 diabetes, the target autoantigens and lesions are restricted to a particular organ. In **non-organ-specific (systemic) autoimmune diseases**, such as SLE and RA, the autoantibodies have widespread reactivity and the lesions involve deposition of circulating immune complexes.

- Patients quite often develop more than one autoimmune disease.

Genetic and environmental influences

- Autoimmune diseases generally involve multiple genetic contributions, including polymorphisms associated with HLA, autoantigens, PRRs, cytokines, cytokine receptors, co-stimulatory and signaling molecules, and transcription factors.
- Seventy-five percent of autoimmune disease occurs in females, most commonly between puberty and the menopause.
- Changes in disease severity can occur during pregnancy.
- Feedback control of lymphocytes through the cytokine–hypothalamus–pituitary–adrenal loop may be defective in

rheumatoid arthritis and some other autoimmune diseases.

- Twin studies reinforce the importance of genetic contributions but also indicate a strong environmental influence.
- Both microbial and nonmicrobial environmental factors are implicated.

Mechanisms

- Autoimmune disease represents a breakdown in immunological tolerance.
- Autoantigen appears to drive the response.
- Most autoantigens are readily accessible to the immune system, but a few such as lens and sperm proteins are sequestered (hidden).
- The development of high-affinity mutated antibodies and immune responses to clusters of anatomically related antigens strongly imply B-cell selection of autoantigen.
- T-cells specific for self peptides usually presented at low concentrations (cryptic epitopes) may not be eliminated in the thymus.
- Abnormal modification of the autoantigen, cross-reaction with exogenous antigens, or “piggy-back” recognition of T-helper epitopes can provide new epitopes for nontolerized helper T-cells.
- B-cells and T-cells can be stimulated directly by polyclonal activators such as Epstein–Barr virus or superantigens.
- Defects in Foxp3⁺ Tregs are implicated in a number of autoimmune diseases.
- De-repression of class II genes giving rise to inappropriate cellular expression of class II may help perpetuate autoimmune reactions initially primed by dendritic cells.
- Cytokine imbalances are often seen in autoimmune disease.

Pathogenic effects of humoral autoantibody

- Autoantibodies are thought to play a central role in many autoimmune diseases, including autoimmune hemolytic anemia, idiopathic thrombocytopenic purpura, Graves’ disease, myasthenia gravis, pernicious anemia, and Goodpasture’s syndrome.
- Passive transfer of disease is seen in “experiments of nature” in which transplacental passage of maternal IgG autoantibody produces a comparable but transient disorder in the fetus and neonate (e.g., Graves’ disease, myasthenia gravis).
- In these diseases where antibody plays a central role, pathology can be mimicked in animal models by passive transfer of monoclonal autoantibodies.

Pathogenic effects of complexes with autoantigens

- Immune complexes, usually with bound complement, appear in the kidneys, skin, and joints of patients with SLE, associated with lesions in the corresponding organs.

- Most patients with RA produce autoantibodies to IgG (rheumatoid factors) that self-associate to form complexes.
- These give rise to acute inflammation in the joint space and stimulate the synovial lining cells to grow as a **pannus**, which **produces erosions in the underlying cartilage and bone** through the release of IL-1 β , IL-6, TNF, collagenase, neutral protease, and reactive oxygen intermediates.

T-cell-mediated hypersensitivity as a pathogenic factor

- Suppression of disease by cyclosporine or anti-CD4 treatment is strong evidence for T-cell involvement. So is an HLA-linked risk factor.
- There is a prevailing view that organ-specific inflammatory lesions are caused by autoreactive pathogenic Th1 and/or Th17 cells.
- Activated T-cells are abundant in the rheumatoid synovium and their production of TNF and IL-15 complements the immune complex stimulus for pannus formation.
- Thyroid epithelial cells often express MHC class II in autoimmune thyroid disease and Th1 cells infiltrate the gland.
- That autoimmunity can cause thyroiditis is further shown by the deliberate induction of disease in rodents through immunization with thyroid antigens in complete Freund’s adjuvant.
- Th1 cells from diseased NOD mice, which mimic the human disorder in histopathology and autoimmunity, can produce typical pancreatic lesions in young mice of the same strain. IL-21 from Th17 cells may also play an important role.
- That autoimmunity plays a central role in MS is suggested by the similarity to experimental autoimmune encephalomyelitis, a demyelinating disease induced by immunization of rodents with myelin in complete Freund’s adjuvant. Approximately one-third of the IL-2 or IL-4 activatable T-cells in the CSF of MS patients are specific for myelin and the HLA-DR2 phenotype is a strong risk factor.

Some other diseases with an autoimmune component

- Immunologically mediated vascular lesions are of central importance in Wegener’s granulomatosis, giant cell arteritis, scleroderma, and atherosclerosis.
- Psoriasis and vitiligo may also be autoimmune diseases.

Measurement of autoantibodies

- A wide range of serum autoantibodies provide valuable diagnostic markers.
- Solid-phase ELISA tests, increasingly in the form of microarrays, are used for the detection of antibodies.
- Immunofluorescent screening can be carried out on sections of normal tissue.

- Agglutination tests for rheumatoid factors and multiplexed addressable laser bead assays are among other commonly employed diagnostic tests.
 - Autoantibody screening can predict future occurrence of autoimmune disease in the close relatives of type 1 diabetics.
- Treatment of autoimmune disorders**
- Therapy involves metabolic control and the use of anti-inflammatory and immunosuppressive drugs.
 - Striking success in RA has been achieved by therapy with anti-TNF.
 - A whole variety of potential immunological control therapies are under intensive investigation. These include wholesale B- and T-cell depletion and attempts to induce antigen-specific tolerance.
 - Restoring defective Treg activity could potentially be of great benefit.
 - Organ-related bystander tolerance means that single epitopes can induce suppression of pathogenic cells within an organ reacting to other epitopes on the same or other antigens.



Now visit www.roitt.com to test yourself on this chapter.

FURTHER READING

- Atkinson M.A., Eisenbarth G.S., and Michels A.W. (2014) Type 1 diabetes. *The Lancet* **383**, 69–82.
- Bugatti S., Codullo V., Caporali R., and Montecucco C. (2007) B cells in rheumatoid arthritis. *Autoimmunity Reviews* **7**, 137–142.
- Chapel M., Haeney M., Misbah S., and Snowden N. (2014) *Essentials of Clinical Immunology*, 6th edn. Blackwell Publishing, Oxford.
- Cunningham M.W. (2009) Molecular mimicry. In *Encyclopedia of Life Sciences*. John Wiley & Sons, Ltd, Chichester.
- Dendrou C.A., Fugger L., and Friese M.A. (2015) Immunopathology of multiple sclerosis. *Nature Reviews Immunology* **15**, 545–558.
- Eizirik D.L., Colli M.L., and Ortis F. (2009) The role of inflammation in insulinitis and β -cell loss in type 1 diabetes. *Nature Reviews Endocrinology* **5**, 219–226.
- Gelfand E.W. (2012) Intravenous immune globulin in autoimmune and inflammatory diseases. *New England Journal of Medicine* **367**, 2015–2025.
- Giannakopoulos B. and Krilis S.A. (2013) The pathogenesis of the antiphospholipid syndrome. *New England Journal of Medicine* **368**, 1033–1044.
- Guilherme L. and Kalil J. (2010) Rheumatic fever and rheumatic heart disease: cellular mechanisms leading to autoimmune reactivity and disease. *Journal of Clinical Immunology* **30**, 17–23.
- Kugelberg E. (2016) Infection stimulates self-antigen presentation. *Nature Reviews Immunology* **16**, 534–535.
- Lowes, M.A. Suárez-Fariñas, M., and Krueger J.G. (2014) Immunology of psoriasis. *Annual Review of Immunology* **32**, 227–255.
- Marsh S.G., Albert E.D., Bodmer W.F., *et al.* (2010) Nomenclature for factors of the HLA system, 2010. *Tissue Antigens* **75**, 291–455.
- Masters S.L., Simon A., Aksentijevich I., and Kastner D.L. (2009) Horror autoinflammaticus: the molecular pathophysiology of autoinflammatory disease. *Annual Review of Immunology* **27**, 621–668.
- Oh S., Rankin A.L., and Caton A.J. (2010) CD4⁺CD25⁺ regulatory T cells in autoimmune arthritis. *Immunological Reviews* **233**, 97–111.
- Pascual V., Chaussabel D., and Banchereau J. (2010) A genomic approach to human autoimmune diseases. *Annual Review of Immunology* **28**, 535–571.
- Rahman A. and Isenberg D.A. (2008) Systemic lupus erythematosus. *The New England Journal of Medicine* **358**, 929–939.
- Rose N.R. and Mackay I.R. (eds.) (2014) *The Autoimmune Diseases*, 5th edn. Elsevier, Oxford.
- Rosen A. and Casciola-Rosen L. (2016) Autoantigens as Partners in Initiation and Propagation of Autoimmune Rheumatic Diseases. *Annual Review of Immunology* **34**, 395–420.
- Steinman L. (2014) Immunology of relapse and remission in multiple sclerosis. *Annual Review of Immunology* **32**, 257–281.
- Tha-In T., Bayry J., Metselaar H.J., Kaveri S.V., and Kwekkeboom J. (2008) Modulation of the cellular immune system by intravenous immunoglobulin. *Trends in Immunology* **29**, 608–615.
- Wahren-Herlenius M. and Dörner T. (2013) Immunopathogenic mechanisms of systemic autoimmune disease. *Lancet* **382**, 819–831.
- Yuki N. and Hartung H-P. (2012) Guillain-Barré Syndrome. *New England Journal of Medicine* **366**, 2294–2304.
- Zenewicz L.A., Abraham C., Flavell R.A., and Cho J.H. (2010) Unraveling the genetics of autoimmunity. *Cell* **140**, 791–797.

Glossary

acquired immune response: Immunity mediated by lymphocytes and characterized by antigen specificity and memory.

acute phase proteins: Serum proteins, mostly produced in the liver, that rapidly change in concentration (some increase, some decrease) during the initiation of an inflammatory response.

addressin: Cell adhesion molecule present on the luminal surface of blood and lymph vessel endothelium, and recognized by homing molecules that direct leukocytes to tissues with the appropriate “address.”

adjuvant: Any substance that nonspecifically enhances the immune response to antigen.

affinity (intrinsic affinity): The strength of binding (affinity constant) between a receptor (e.g., one antigen-binding site on an antibody) and a ligand (e.g., epitope on an antigen).

affinity chromatography: The use of immobilized antibody (or antigen) to select specific antigen (or antibody) from a mixture. The purified ligand is then released by disrupting the antibody–antigen interaction, for example by changing the pH.

allele: Variants of a polymorphic gene at a given genetic locus.

allelic exclusion: The phenomenon whereby, following successful rearrangement of one allele of an antigen receptor gene, rearrangement of the other parental allele is suppressed.

allergen: An antigen that causes allergy.

allergy: IgE-mediated hypersensitivity (e.g., asthma, eczema, hayfever, and food allergy).

allogeneic: Refers to the genetic differences between individuals of the same species.

allograft: Tissue or organ graft between allogeneic individuals.

allotype: An allelic variant of an antigen that, because it is not present in all individuals, may be immunogenic in members of the same species that have a different version of the allele.

alternative pathway (of complement activation):

Activation pathway involving complement components C3, factor B, factor D, and properdin that, in the presence of a stabilizing activator surface such as microbial polysaccharide, generates the alternative pathway C3 convertase C_3bBb .

anaphylatoxin: A substance (e.g., C3a, C4a, or C5a) capable of directly triggering mast cell degranulation.

anaphylaxis: An often fatal hypersensitivity reaction, triggered by IgE or anaphylatoxin-mediated mast cell degranulation, leading to anaphylactic shock due to vasodilatation and smooth muscle contraction.

anergy: Potentially reversible specific immunological tolerance in which the lymphocyte becomes functionally nonresponsive.

antibody-dependent cellular cytotoxicity (ADCC):

A cytotoxic reaction in which an antibody-coated target cell is directly killed by an Fc receptor-bearing leukocyte (e.g., NK cell, macrophage, or neutrophil).

antigen: Any molecule capable of being recognized by an antibody or T-cell receptor.

antigenic determinant: A cluster of epitopes (*see* epitope).

antigen-presenting cell (APC): A term most commonly used when referring to cells that present processed antigenic peptide and MHC class II molecules to the T-cell receptor on CD4⁺ T-cells (e.g., dendritic cells, macrophages, B-cells). Note, however, that most types of cell are able to present antigenic peptides with MHC class I to CD8⁺ T-cells (e.g., as occurs with virally infected cells).

apoptosis: A form of programmed cell death characterized by endonuclease digestion of DNA.

atopic allergy: IgE-mediated hypersensitivity (e.g., asthma, eczema, hayfever, and food allergy).

autologous: From the same individual.

avidity (functional affinity): The binding strength between two molecules (e.g., antibody and antigen) taking into account the valency of the interaction. Thus the avidity will always be equal to or greater than the intrinsic affinity (*see* affinity).

basophil: A type of granulocyte found in the blood and resembling the tissue mast cell.

BCG (bacille Calmette–Guérin): Attenuated *Mycobacterium tuberculosis*, used both as a specific vaccine for tuberculosis and as an adjuvant.

β_2 -microglobulin: A 12 kDa protein, not itself encoded within the MHC, but forming part of the structure of MHC class I-encoded molecules.

biolistics: The use of small particles (e.g., colloidal gold) as a vehicle for carrying agents (drugs, nucleic acid, etc.) into a cell. Following coating with the desired agent(s), the particles are fired into the dermis of the recipient using a helium-powered gun.

bispecific antibody: An artificially produced hybrid antibody in which each of the two antigen-binding arms is specific for a different antigenic epitope. Such antibodies, which can be produced either by chemical cross-linkage or by recombinant DNA techniques, can be used to link together two different antigens or cells (e.g., a cytotoxic T-cell and a tumor cell).

B-1/B-2-cells: The two major subpopulations of B-lymphocytes. B-1 cells bear high levels of surface IgM, lower levels of surface IgD, are CD43⁺ CD23⁻ and most express the cell surface antigen CD5; they are self-renewing, and frequently secrete high levels of antibody, which binds to a range of antigens (“polyspecificity”) with a relatively low affinity. The majority of B-cells, however, are B-2, which express low levels of surface IgM, higher levels of surface IgD, do not express CD5, and are CD43⁻ CD23⁺; they are directly generated from precursors in the bone marrow and secrete highly specific antibody.

bursa of Fabricius: A primary lymphoid organ in avian species, located at the cloacal–hind gut junction; it is the site of B-cell maturation.

capping: An active process whereby cross-linking of cell surface molecules (e.g., by antibody) leads to

aggregation and subsequent migration of the molecules to one pole of the cell.

carrier: Any molecule that when conjugated to a nonimmunogenic molecule (e.g., a hapten) makes the latter immunogenic by providing epitopes for helper T-cells which the hapten lacks.

caspases: A family of cysteine proteases involved in generating apoptosis.

CD antigen: Cluster of differentiation designation assigned to leukocyte cell surface molecules that are identified by a given group of monoclonal antibodies.

CD3: A trimeric complex of γ , δ , and ϵ chains that together with a $\zeta\zeta$ homodimer or $\zeta\eta$ heterodimer acts as a signal transducing unit for the T-cell receptor.

CD4: Cell surface glycoprotein, usually on helper T-cells, that recognizes MHC class II molecules on antigen-presenting cells.

CD8: Cell surface glycoprotein, usually on cytotoxic T-cells, that recognizes MHC class I molecules on target cells.

cell-mediated immunity (CMI): Refers to T-cell-mediated immune responses.

central memory: Immunological memory that is dependent on CCR7⁺ T-cells that, under the influence of chemokines, travel to secondary lymphoid organs where they give rise to CCR7⁻ effector memory T-cells.

central tolerance: Specific immunological tolerance due to the induction of lymphocyte apoptosis or anergy within the primary lymphoid organs (bone marrow in the case of B-cell tolerance and the thymus for T-cells).

chemokines: A family of structurally related cytokines that selectively induce chemotaxis and activation of leukocytes. They also play important roles in lymphoid organ development, cell compartmentalization within lymphoid tissues, Th1/Th2 development, angiogenesis, and wound healing.

chemotaxis: Movement of cells up a concentration gradient of chemotactic factors.

chimeric: Composite of genetically distinct individuals (e.g., following an allogeneic bone marrow graft).

citruination: The enzymatic conversion, by peptidyl arginine deiminase, of an arginine in a protein to a citrulline.

classical pathway (of complement activation):

Activation pathway involving complement components C1, C2, and C4 that, following fixation of C1q (e.g., by antigen–antibody complexes), produces the classical pathway C3 convertase C_{4b2a}.

class switching: The process by which a B-cell changes the class but not specificity of a given antibody it produces (e.g., switching from an IgM to an IgG antibody).

class switch recombination: The recombination of immunoglobulin heavy chain constant region gene segments (e.g., switching from C_μ and C_δ to C_{γ1} to convert an IgM (and IgD) antibody into an IgG1 antibody).

clonal deletion: A process by which contact with antigen (e.g., self antigen) at an early stage of lymphocyte differentiation leads to cell death by apoptosis.

clonal selection: The selection and activation by antigen of a lymphocyte bearing a complementary receptor, which then proliferates to form an expanded clone.

clone: Identical cells derived from a single progenitor.

colony-stimulating factors (CSF): Factors that permit the proliferation and differentiation of hematopoietic cells.

combinatorial diversity: That component of antibody and T-cell receptor (TCR) diversity that is generated by the recombination of variable (*V*), diversity (*D*, for immunoglobulin heavy chains, and for TCR β and δ chains), and joining (*J*) gene segments.

complement: A group of serum proteins, some of which act in an enzymatic cascade, producing effector molecules involved in inflammation (C3a, C5a), phagocytosis (C3b), and cell lysis (C5b–9).

complementarity determining regions (CDR): The hypervariable amino acid sequences within antibody and T-cell receptor variable regions that interact with complementary amino acids on the antigen or peptide–MHC complex.

ConA (concanavalin A): A T-cell mitogen.

congenic: Animals that only differ only at a single genetic locus.

conjugate: Covalently linked complex of two or more molecules (e.g., fluorescein conjugated to antibody).

convergent evolution: Independent evolution of similarity between molecules or between species.

Coombs' test: Diagnostic test using anti-immunoglobulin to agglutinate antibody-coated erythrocytes.

cortex: Outer (peripheral) layer of an organ.

C-reactive protein: An acute phase protein that is able to bind to the surface of microorganisms where it functions as a stimulator of the classical pathway of complement activation, and as an opsonin for phagocytosis.

cyclophosphamide: Cytotoxic drug used as an immunosuppressive.

cyclosporine: A T-cell-specific immunosuppressive drug used to prevent graft rejection.

cytokines: Low-molecular-weight proteins that stimulate or inhibit the differentiation, proliferation or function of immune cells.

cytophilic: Binds to cells.

cytotoxic: Kills cells.

cytotoxic T-lymphocyte (CTL, Tc): T-cells (usually CD8⁺) that kill target cells following recognition of foreign peptide–MHC molecules on the target cell membrane.

danger-associated molecular pattern (DAMP): A structure or molecule produced by necrotic cells and which provides danger signals to activate the immune response following tissue damage.

defensins: A family of small basic antimicrobial peptides, produced by both animals and plants.

delayed-type hypersensitivity (DTH): A hypersensitivity reaction occurring within 48–72 hours and mediated by cytokine release from sensitized T-cells.

dendritic cell (DC): Refers to an interdigitating dendritic cell that is MHC class II positive and presents processed antigens to T-cells in the T-cell areas of secondary lymphoid tissues. (Note: This is a different cell type to follicular dendritic cells.)

differential splicing: The utilization and splicing of different exons from a primary RNA transcript in order to generate different mRNA sequences.

- differentiation antigen:** A cell surface molecule expressed at a particular stage of development or on cells of a given lineage.
- DiGeorge syndrome:** Immunodeficiency caused by a congenital failure in thymic development resulting in a lack of mature functional T-cells.
- diversity (D) gene segments:** Found in the immunoglobulin heavy chain gene and T-cell receptor β and δ gene loci between the *V* and *J* gene segments. They encode part of the third hypervariable region (CDR3) in these antigen receptor chains.
- domain:** A structural element of a polypeptide.
- edema:** Swelling caused by accumulation of fluid in the tissues.
- effector cells:** Cells that carry out an immune function (e.g., cytokine release, cytotoxicity).
- ELISA (enzyme-linked immunosorbent assay):** Assay for detection or quantitation of an antibody or antigen using a ligand (e.g., an anti-immunoglobulin) conjugated to an enzyme that changes the color of a substrate.
- endocytosis:** Cellular ingestion of macromolecules by invagination of plasma membrane to produce an intracellular vesicle that encloses the ingested material.
- endogenous:** From within.
- endosomes:** Intracellular smooth-surfaced vesicles in which endocytosed material passes on its way to the lysosomes.
- endotoxin:** Pathogenic cell wall-associated lipopolysaccharides of Gram-negative bacteria.
- eosinophil:** A class of granulocyte, the granules of which contain toxic cationic proteins.
- epitope:** That part of an antigen recognized by an antigen receptor (*see* antigenic determinant).
- Epstein-Barr virus (EBV):** The virus responsible for infectious mononucleosis and Burkitt's lymphoma. Can be used to immortalize human B-cells *in vitro*.
- equivalence:** The ratio of antibody to antigen at which immunoprecipitation of the reactants is virtually complete.
- erythema:** The redness produced during inflammation due to erythrocytes entering tissue spaces.
- erythropoiesis:** Erythrocyte production.
- exotoxin:** Pathogenic protein secreted by bacteria.
- exudate:** The extravascular fluid (containing proteins and cellular debris) that accumulates during inflammation.
- Fab:** Monovalent antigen-binding fragment obtained following papain digestion of immunoglobulin. Consists of an intact light chain and the N-terminal V_H and C_{H1} domains of the heavy chain.
- F(ab')₂:** Bivalent antigen-binding fragment obtained following pepsin digestion of immunoglobulin. Consists of both light chains and the N-terminal part of both heavy chains linked by disulfide bonds.
- Fas:** A member of the TNF receptor gene family. Engagement of Fas (CD95) on the surface of the cell by the Fas ligand (CD178) present on cytotoxic cells can trigger apoptosis in the Fas-bearing target cell.
- Fc:** Crystallizable, nonantigen-binding fragment of an immunoglobulin molecule obtained following papain digestion. Consists of the C-terminal portion of both heavy chains that is responsible for binding to Fc receptors and C1q.
- Fc receptors:** Cell surface receptors that bind the Fc portion of particular immunoglobulin classes.
- fibroblast:** Connective tissue cell that produces collagen and plays an important part in wound healing.
- fluorescein isothiocyanate (FITC):** Green fluorescent dye used to "tag" antibodies for use in immunofluorescence.
- fluorescent antibody:** An antibody conjugated to a fluorescent dye such as FITC.
- foam cell:** Macrophages that have engulfed low-density lipoproteins. They are characteristically present in atherosclerotic plaques.
- follicular dendritic cell:** MHC class II-negative Fc receptor-positive dendritic cells that bear immune complexes on their surface and are involved in the stimulation of B-cells and maintenance of B-cell memory in germinal centers. (Note: This is a different cell type to interdigitating dendritic cells).
- follicular helper T-cell:** Subset of helper T-cells that direct B-cell development, class switch recombination and survival within germinal centers.
- Foxp3:** A transcription factor present in the nucleus of most regulatory T-cells.

- framework regions:** The relatively conserved amino acid sequences that flank the hypervariable regions in immunoglobulin and T-cell receptor variable regions and maintain a common overall structure for all V-region domains.
- Freund's adjuvant:** Complete Freund's adjuvant is an emulsion of aqueous antigen in mineral oil that contains heat-killed mycobacteria. Incomplete Freund's adjuvant lacks the mycobacteria.
- Fv:** The variable region fragment of an antibody heavy or light chain.
- γ -globulin:** The serum proteins, mostly immunoglobulins, which have the greatest mobility towards the cathode during electrophoresis.
- germinal center:** Discrete areas within secondary lymphoid tissues where B-cell maturation and memory development occur.
- germline:** The arrangement of the genetic material as transmitted through the gametes.
- giant cell:** Large multinucleate cell derived from fused macrophages and often present in granulomas.
- glomerulonephritis:** Inflammation of renal glomerular capillary loops, often resulting from immune complex deposition.
- graft-versus-host (GVH) reaction:** Reaction occurring when T-lymphocytes present in a graft recognize and attack host cells.
- granulocyte:** Myeloid cells containing cytoplasmic granules (i.e., neutrophils, eosinophils, and basophils).
- granuloma:** A tissue nodule containing proliferating lymphocytes, fibroblasts, and giant cells and epithelioid cells (both derived from activated macrophages), which forms due to inflammation in response to chronic infection or persistence of antigen in the tissues.
- granzymes:** Serine esterases present in the granules of cytotoxic T-lymphocytes and NK cells. They induce apoptosis in the target cell that they enter through perforin channels inserted into the target cell membrane by the cytotoxic cell.
- gut-associated lymphoid tissue (GALT):** Includes Peyer's patches, appendix, and solitary lymphoid nodules in the submucosa.
- haplotype:** The set of allelic variants present at a given genetic region.
- haptens:** A low-molecular-weight molecule that is recognized by preformed antibody but is not itself immunogenic unless conjugated to a "carrier" molecule that provides epitopes recognized by helper T-cells.
- helper T-lymphocyte (Th):** A subclass of T-cells that provide help (in the form of cytokines and/or cognate interactions) necessary for the expression of effector function by other cells in the immune system.
- hemagglutinin:** Any molecule that agglutinates erythrocytes.
- hematopoiesis:** The production of erythrocytes, leukocytes, and platelets.
- hematopoietic stem cells:** Self-renewing stem cells that are capable of giving rise to all of the formed elements of the blood (i.e., leukocytes, erythrocytes, and platelets).
- heterozygous:** Possessing different alleles at a given locus on the two homologous chromosomes.
- high endothelial venule (HEV):** Capillary venule composed of specialized endothelial cells allowing migration of lymphocytes into lymphoid organs.
- hinge region:** Amino acids between the Fab and Fc regions of immunoglobulin that permit flexibility of the molecule.
- histamine:** Vasoactive amine present in basophil and mast cell granules that, following degranulation, causes increased vascular permeability and smooth muscle contraction.
- HLA (human leukocyte antigen):** The human major histocompatibility complex (MHC).
- homing receptors:** Cell surface molecules that direct leukocytes to specific locations in the body.
- homozygous:** Possessing the same allele at a given locus on the two homologous chromosomes.
- H-2:** The mouse major histocompatibility complex (MHC).
- humanized antibody:** A genetically engineered monoclonal antibody of nonhuman origin in which all but the antigen-binding CDR sequences have been replaced with sequences derived from human antibodies. This procedure is carried out to minimize the immunogenicity of therapeutic monoclonal antibodies.
- humoral:** Pertaining to extracellular fluid such as plasma and lymph. The term humoral immunity

- is used to denote antibody-mediated immune responses.
- hybridoma:** Hybrid cell line obtained by fusing a lymphoid tumor cell with a lymphocyte that then has both the immortality of the tumor cell and the effector function (e.g., monoclonal antibody secretion) of the lymphocyte.
- hypersensitivity:** Excessive immune response that leads to undesirable consequences (e.g., tissue or organ damage).
- hypervariable regions:** Those amino acid sequences within the immunoglobulin and T-cell receptor variable regions that show the greatest variability and contribute most to the antigen or peptide-MHC binding site.
- idiotope:** An epitope made up of amino acids within the variable region of an antibody or T-cell receptor that reacts with an anti-idiotope.
- idiotype:** The complete set of idiotopes in the variable region of an antibody or T-cell receptor that react with an anti-idiotypic serum.
- idiotype network:** A regulatory network based on interactions of idiotypes and anti-idiotypes present on antibodies and T-cell receptors.
- immune complex:** Complex of antibody bound to antigen that may also contain complement components.
- immunoabsorption:** Method for removal of antibody or antigen by allowing it to bind to solid phase antigen or antibody.
- immunofluorescence:** Technique for detection of cell- or tissue-associated antigens by the use of a fluorescently tagged ligand (e.g., an anti-immunoglobulin conjugated to fluorescein isothiocyanate).
- immunogen:** Any substance that elicits an immune response. Although all immunogens are antigens, not all antigens are immunogens (*see* hapten).
- immunoglobulin superfamily:** Large family of proteins characterized by possession of “immunoglobulin-type” domains of approximately 110 amino acids folded into two β -pleated sheets. Members include immunoglobulins, T-cell receptors, and MHC molecules.
- immunological synapse:** A contact point between the T-cell and antigen-presenting cell that is generated by reorganization and clustering of cell surface molecules in lipid rafts. The synapse facilitates interactions between TCR and MHC, co-stimulatory and adhesion molecules, thereby potentiating the TCR-mediated activation signal.
- immunotoxin:** A biochemical conjugate, or recombinant fusion protein, consisting of an immune targeting molecule such as an antibody or antibody fragment together with a cytotoxic molecule.
- inflammasome:** A multi-protein cytoplasmic complex that promotes inflammation by converting the IL-1 β precursor into active IL-1 β , and additionally by stimulating the generation of IL-18.
- inflammation:** The tissue response to trauma, characterized by increased blood flow and entry of leukocytes into the tissues, resulting in swelling, redness, elevated temperature, and pain.
- innate immunity:** Immunity that is not intrinsically affected by prior contact with antigen (i.e., all aspects of immunity not directly mediated by lymphocytes).
- integrins:** A family of heterodimeric cell adhesion molecules.
- interdigitating dendritic cell:** MHC class II-positive antigen-presenting dendritic cell found in T-cell areas of lymph nodes and spleen. (Note: This is a different cell type to follicular dendritic cells.)
- interferons (IFN):** IFN α and IFN β (type I interferons) can be induced in most cell types, whereas IFN γ (type II interferon) is produced by T-lymphocytes and NK cells. All three types induce an antiviral state in cells and IFN γ additionally acts in the regulation of immune responses.
- interleukins (IL):** Designation for some of the cytokines secreted by leukocytes.
- internal image:** An epitope on an anti-idiotypic that binds in a way that structurally and functionally mimics the antigen.
- invariant chain:** A polypeptide that binds MHC class II molecules in the endoplasmic reticulum, directs them to the late endosomal compartment and prevents premature association with self peptides.
- Ir (immune response) genes:** The genes, including those within the MHC, that together determine the overall level of immune response to a given antigen.

isotype: An antibody constant region structure present in all normal individuals (i.e., antibody class or subclass).

ITAM: Immunoreceptor tyrosine-based activation motifs are amino acid consensus sequences recognized by src-family tyrosine kinases. These motifs are found in the cytoplasmic domains of several signaling molecules including the signal transduction units of lymphocyte antigen receptors and of Fc receptors.

ITIM: Immunoreceptor tyrosine-based inhibitory motifs present in the cytoplasmic domains of certain cell surface molecules (e.g., Fc γ RIIB, inhibitory NK cell receptors), and that mediate inhibitory signals.

J chain: A molecule that forms part of the structure of pentameric IgM and dimeric IgA.

joining (J) gene segments: Found in the immunoglobulin and T-cell receptor gene loci and, upon gene rearrangement, encode part of the third hypervariable region (CDR3) of the antigen receptors.

junctional diversity: Diversity of the splice junctions in the recombined variable (V), diversity (D, for immunoglobulin heavy chains, and for TCR β and δ chains), and joining (J) gene segments of antibody and T-cell receptor (TCR) genes.

K (killer) cell: A generic term for any leukocyte that mediates antibody-dependent cellular cytotoxicity (ADCC).

kinins: A family of polypeptides released during inflammatory responses and that increase vascular permeability and smooth muscle contraction.

KIRs: Killer cell immunoglobulin-like receptors found on NK cells, some $\gamma\delta$ and some $\alpha\beta$ T-cells. KIRs recognize MHC class I molecules and, like the C-type lectin receptors also found on these cells, can either inhibit or activate the killer cells. If ITIM sequences are present in their cytoplasmic domain they are inhibitory. KIRs lacking ITIMs can associate with ITAM-containing adaptor molecules, in which case they can activate the NK cell or T-cell.

knockout: The use of homologous genetic recombination in embryonal stem cells to replace a functional gene with a defective copy of the gene. The animals

that are produced by this technique can be bred to homozygosity, thus allowing the generation of a null phenotype for that gene product.

Kupffer cells: Fixed tissue macrophages lining the blood sinuses in the liver.

lamina propria: The connective tissue underlying the epithelium at mucosal sites.

Langerhans cell: Fc receptor and MHC class II-positive antigen-presenting dendritic cell found in the skin.

large granular lymphocyte (LGL): Leukocytes (most are not actually true lymphocytes) that contain cytoplasmic granules and function as natural killer (NK) and killer (K) cells. Activated CD8⁺ cytotoxic T-lymphocytes (Tc) also assume an LGL morphology.

lectins: A family of proteins that bind specific sugars on glycoproteins and glycolipids. Some plant lectins are mitogenic (e.g., PHA, ConA).

leukocyte: White blood cells, which include neutrophils, basophils, eosinophils, lymphocytes, NK cells, and monocytes.

leukotrienes: Metabolic products of arachidonic acid that promote inflammatory processes (e.g., chemotaxis, increased vascular permeability) and are produced by a variety of cell types including mast cells, basophils, and macrophages.

ligand: General term for a molecule recognized by a binding structure such as a receptor.

linkage disequilibrium: The occurrence of two alleles being inherited together at a greater frequency than that expected from the product of their individual frequencies.

lipid raft: Cholesterol- and glycosphingolipid-rich membrane subdomain in which molecules involved in cellular activation become concentrated.

lipopolysaccharide (LPS): Endotoxin derived from Gram-negative bacterial cell walls that has inflammatory and mitogenic actions.

lymph: The tissue fluid that drains into and through the lymphatic system.

lymphadenopathy: Enlarged lymph nodes.

lymphotoxin (also called TNF β): A T-cell-derived cytokine that is cytotoxic for certain tumor cells and also has immunoregulatory functions.

lysosomes: Membrane-bound cytoplasmic organelles containing hydrolytic enzymes involved in the digestion of phagocytosed material.

lysozyme: Antibacterial enzyme present in phagocytic cell granules, tears, and saliva, which digests peptidoglycans in bacterial cell walls.

macrophage: Large phagocytic cell, derived from the blood monocyte, which also functions as an antigen-presenting cell and can mediate ADCC.

mannose binding lectin (mannose binding protein): A member of the collectin family of calcium-dependent lectins, and an acute phase protein. It functions as a stimulator of the lectin pathway of complement activation, and as an opsonin for phagocytosis by binding to mannose, a sugar residue usually found in an exposed form only on the surface of microorganisms.

marginal zone: The outer area of the splenic periarteriolar lymphoid sheath (PALS) that is rich in B-cells, particularly those responding to thymus-independent antigens.

margination: Leukocyte adhesion to the endothelium of blood vessels in the early phase of an acute inflammatory reaction.

mast cell: A tissue cell with abundant granules that resembles the blood basophil. Both these cell types bear high-affinity Fc receptors for IgE, which when cross-linked by IgE and antigen cause degranulation and the release of a number of mediators including histamine and leukotrienes.

medulla: Inner (central) region of an organ.

megakaryocyte: A bone marrow precursor of platelets.

membrane attack complex (MAC): Complex of complement components C5b–C9 that inserts as a pore into the membrane of target cells, leading to cell lysis or apoptosis.

memory (immunological): A characteristic of the acquired immune response of lymphocytes whereby a second encounter with a given antigen produces a secondary immune response, which is faster, greater, and longer lasting than the primary immune response.

memory cells: Clonally expanded T- and B-cells produced during a primary immune response and that are “primed” to mediate a secondary immune response to the original antigen.

MHC (major histocompatibility complex): A genetic region encoding molecules involved in antigen presentation to T-cells. Class I MHC molecules are present on virtually all nucleated cells and are encoded mainly by the H-2K, H-2D, and H-2L loci in mice and by HLA-A, HLA-B, and HLA-C in humans, while class II MHC molecules are expressed on antigen-presenting cells (primarily dendritic cells, macrophages, and B-cells) and are encoded by H-2A and H-2E in mice and HLA-DR, HLA-DQ, and HLA-DP in humans. Allelic differences are associated with the most intense graft rejection within a species.

MHC restriction: The necessity that T-cells recognize processed antigen only when presented by MHC molecules of the original haplotype associated with T-cell priming.

minor histocompatibility antigens: Non-MHC-encoded processed peptides derived from the allogeneic products of polymorphic gene loci. In association with MHC-encoded molecules they contribute to graft rejection, albeit not usually as severe as that due to MHC mismatch.

mitogen: A substance that nonspecifically induces lymphocyte proliferation.

mixed lymphocyte reaction (MLR): A T-cell proliferative response induced by cells expressing allogeneic MHC.

monoclonal antibody: Homogeneous antibody derived from a single B-cell clone and therefore all bearing identical antigen-binding sites and isotype.

monocyte: Mononuclear phagocyte found in blood and that is the precursor of the tissue macrophage.

mononuclear phagocyte system: A system comprising blood monocytes and tissue macrophages.

mucosa-associated lymphoid tissue (MALT): Lymphoid tissue present in the surface mucosa of the respiratory, gastrointestinal, and genitourinary tracts.

multiple myeloma: Plasma cell malignancy resulting in high levels of monoclonal immunoglobulin in serum and of free light chains (Bence Jones protein) in urine.

murine: Pertaining to mice.

myeloma protein: Monoclonal antibody secreted by myeloma cells.

naive lymphocyte: A mature T- or B-cell that has not yet been activated by initial encounter with antigen.

negative selection: Deletion by apoptosis in the thymus of T-cells that recognize self peptides presented by self MHC molecules, thus preventing the development of autoimmune T-cells. Negative selection of developing B-cells also occurs if they encounter high levels of self antigen in the bone marrow.

neutrophil: The major circulating phagocytic polymorphonuclear granulocyte. Enters tissues early in an inflammatory response and is also able to mediate antibody-dependent cellular cytotoxicity (ADCC).

NK (natural killer) cell: Large granular leukocyte that does not rearrange nor express either immunoglobulin or T-cell receptor genes but is able to recognize and destroy certain tumor and virally infected cells in an MHC- and antibody-independent manner. Also able to mediate ADCC.

NKT cell: NK1.1⁺ lymphoid cells with a morphology and granule content intermediate between T-cells and NK cells. They express low levels of $\alpha\beta$ TCR with an invariant α chain and very restricted β chain specificity, recognize lipid and glycolipid antigens presented by the nonclassical MHC-like molecule CD1d, and are potent producers of IL-4 and IFN γ .

N-nucleotides: Nontemplated nucleotides added to the junctions between antibody and T-cell receptor variable (*V*), diversity (*D*), and joining (*J*) gene segments during gene rearrangement.

NOD-like receptor: A family of cytoplasmic pattern recognition receptors involved in sensing the presence of pathogens.

nude mouse: Mouse that is T-cell deficient due to a homozygous gene defect (*nu/nu*) resulting in the absence of a thymus (and also lack of body hair).

oligoclonal: A few different clones, or the product of a few different clones.

oncofetal antigen: Antigen whose expression is normally restricted to the fetus but that may be expressed during malignancy in adults.

opsonin: Substance (e.g., antibody or C3b) that enhances phagocytosis by promoting adhesion of the antigen to the phagocyte.

opsonization: Coating of antigen with opsonin to enhance phagocytosis.

PAF (platelet activating factor): An alkyl phospholipid released by a variety of cell types including mast cells and basophils, which has immunoregulatory effects on lymphocytes and monocytes/macrophages as well as causing platelet aggregation and degranulation.

paracortex: The part of an organ (e.g., lymph node) that lies between the cortex and the medulla.

pathogen-associated molecular pattern (PAMP): Molecules such as lipopolysaccharide, peptidoglycan, lipoteichoic acids, and mannans, which are widely expressed by microbial pathogens as repetitive motifs but are not present on host tissues. They are therefore utilized by the pattern recognition receptors (PRRs) of the immune system to distinguish pathogens from self antigens.

pattern recognition receptor (PRR): Cell-associated or soluble receptors that enable the immune system to detect pathogen-associated molecular patterns (PAMPs) and danger-associated molecular patterns (DAMPs). Among the large number of different PRRs are the mannose receptor (CD206), macrophage scavenger receptor (CD204), and the Toll-like receptors.

perforin: Molecule produced by cytotoxic T-cells and NK cells that, like complement component C9, polymerizes to form a pore in the membrane of the target cell leading to cell death.

periarteriolar lymphoid sheath (PALS): The lymphoid tissue that forms the white pulp of the spleen.

peripheral tolerance: Specific immunological tolerance occurring outside of the primary lymphoid organs.

Peyer's patches: Part of the gut-associated lymphoid tissue (GALT) and found as distinct lymphoid nodules mainly in the small intestine.

PHA (phytohemagglutinin): A plant lectin that acts as a T-cell mitogen.

phage antibody library: A collection of cloned antibody variable region gene sequences that can be expressed as Fab or scFv fusion proteins with bacteriophage coat proteins. These can be displayed on the surface of the phages. The gene encoding a monoclonal recombinant antibody is enclosed

- in the phage particle and can be selected from the library by binding of the phage to specific antigen.
- phagocyte:** Cells (including monocytes/macrophages and neutrophils) that are specialized for the engulfment of cellular and particulate matter.
- phagolysosome:** Intracellular vacuole where killing and digestion of phagocytosed material occurs following the fusion of a phagosome with a lysosome.
- phagosome:** Intracellular vacuole produced following invagination of the cell membrane around phagocytosed material.
- phorbol myristate acetate (PMA):** A mitogenic phorbol ester that directly stimulates protein kinase C and acts as a tumor promoter.
- plaque-forming cell (PFC):** Antibody-secreting plasma cell detected *in vitro* by its ability to produce a “plaque” of lysed antigen-sensitized erythrocytes in the presence of complement.
- plasma cell:** Terminally differentiated B-lymphocyte that actively secretes large amounts of antibody.
- pluripotent stem cell:** A cell that has the potential to differentiate into many different cell types.
- P-nucleotides:** Palindromic nucleotide sequences generated at the junctions between antibody and T-cell receptor variable (*V*), diversity (*D*), and joining (*J*) gene segments during gene rearrangement.
- pokeweed mitogen (PWM):** A plant lectin that is a T-cell-dependent B-cell mitogen.
- polyclonal:** Many different clones, or the product of many different clones (e.g., polyclonal antiserum).
- poly-Ig receptor:** A receptor molecule that specifically binds J-chain containing polymeric Ig (i.e., dimeric secretory IgA and pentameric IgM) and transports it across mucosal epithelium.
- polymorphic:** Highly variable in structure or sequence.
- positive selection:** The selection of those developing T-cells in the thymus that are able to recognize self MHC molecules. This occurs by preventing apoptosis in these cells.
- precipitin:** Precipitate of antibody and multivalent antigen due to the formation of high molecular weight complexes.
- primary immune response:** The relatively weak immune response that occurs upon the first encounter of naive lymphocytes with a given antigen.
- primary lymphoid organs:** The sites at which immunocompetent lymphocytes develop (i.e., bone marrow and thymus in mammals).
- prime:** The process of giving an initial sensitization to antigen.
- prostaglandins:** Acidic lipids derived from arachidonic acid that are able to increase vascular permeability, mediate fever, and can both stimulate and inhibit immunological responses.
- proteasome:** Cytoplasmic proteolytic enzyme complex involved in antigen processing to generate peptides for association with MHC.
- protein A:** *Staphylococcus aureus* cell wall protein that binds to the Fc region of IgG.
- protein tyrosine kinases:** Enzymes that are able to phosphorylate proteins on tyrosines, and often act in a cascade-like fashion in the signal transduction systems of cells.
- Qa antigens:** “Nonclassical” MHC class I molecules of mice.
- radioimmunoconjugate:** A biochemical conjugate consisting of an immune targeting molecule such as an antibody or antibody fragment together with a cytotoxic radionuclide.
- recombination signal sequence (RSS):** Conserved heptamer (7-nucleotide)-nonamer (9-nucleotide) sequences, separated by a 12 or 23 base spacer, which occur 3' of variable gene segments, 5' and 3' of diversity gene segments, and 5' of joining gene segments, in both immunoglobulin and T-cell receptor genes. They function as recognition sequences for the recombinase enzymes that mediate the gene rearrangement process involved in the generation of lymphocyte antigen receptor diversity.
- regulatory idiotope:** An antibody or T-cell receptor idiotope capable of regulating immune responses via interaction with lymphocytes bearing complementary idiotopes (anti-idiotopes).
- regulatory T-cell:** T-cells, mostly CD4⁺, that suppress the functional activity of lymphocytes and dendritic cells.
- respiratory burst:** The increased oxidative metabolism that occurs in phagocytic cells following activation.

reticuloendothelial system (RES): A rather old term for the network of phagocytes and endothelial cells throughout the body.

rheumatoid factor: IgM, IgG, and IgA autoantibodies to the Fc region of IgG.

rosette: Particles or cells bound to the surface of a lymphocyte (e.g., sheep erythrocytes around a human T-cell).

scavenger receptors: Cell surface receptors, for example on phagocytic cells, that recognize cells or molecules that require clearance from the body.

scFv: A single-chain molecule composed of the variable regions of an antibody heavy and light chain joined together by a flexible linker.

SCID (severe combined immunodeficiency): Immunodeficiency affecting both T- and B-lymphocytes.

secondary immune response: The qualitatively and quantitatively improved immune response that occurs upon the second encounter of primed lymphocytes with a given antigen.

secretory component: Proteolytic cleavage product of the poly-Ig receptor that remains associated with dimeric IgA in sero-mucous secretions.

secretory IgA: Dimeric IgA found in sero-mucous secretions.

somatic hypermutation: The enhanced occurrence of point mutations in the recombined immunoglobulin variable region $V(D)J$ genes that occurs following antigenic stimulation and acts as a mechanism for increasing antibody diversity and affinity.

stem cell: Multipotential cell from which differentiated cells derive.

stochastic: A process involving at least some element of randomness.

superantigen: An antigen that reacts with all the lymphocytes belonging to a particular T-cell receptor or immunoglobulin V region family, and that therefore stimulates (or deletes) a much larger number of cells than does conventional antigen.

surface plasmon resonance: A technique based upon changes in the angle of reflected light that occur upon ligand binding to an immobilized target molecule on a biosensor chip. This permits the observation of protein-protein interac-

tions (such as antibody binding to an antigen) in “real-time” (i.e., by continuous monitoring of the association and dissociation of the reversible reaction).

switch sequences: Highly conserved repetitive sequences that mediate class switching in the immunoglobulin heavy chain gene locus.

syngeneic: Genetically identical (e.g., a fully inbred strain of mice).

systemic: Throughout the body.

TAP: The transporters associated with antigen processing (TAP-1 and TAP-2) are molecules that carry antigenic peptides from the cytoplasm into the lumen of the endoplasmic reticulum for incorporation into MHC class I molecules.

T-cell receptor (TCR): The heterodimeric antigen receptor of the T-lymphocyte exists in two alternative forms, consisting of α and β chains, or γ and δ chains. The $\alpha\beta$ TCR recognizes peptide fragments of protein antigens presented by MHC molecules on cell surfaces. The function of the $\gamma\delta$ TCR is less clearly defined but it can often recognize native proteins on the cell surface.

T-dependent antigen: An antigen that requires helper T-cells in order to elicit an antibody response.

thymocyte: Developing T-cell in the thymus.

T-independent antigen: An antigen that is able to elicit an antibody response in the absence of T-cells.

titer: Measure of the relative “strength” (a combination of amount and avidity) of an antibody or antiserum, usually given as the highest dilution that is still operationally detectable in, for example, an ELISA.

tolerance: Specific immunological unresponsiveness.

tolerogen: An antigen used to induce tolerance. Often depends more on the circumstances of administration (e.g., route and concentration) than on any inherent property of the molecule.

Toll-like receptors (TLRs): A family of pattern recognition receptors involved in the detection of structures associated with pathogens or damaged host tissues.

toxoid: Chemically or physically modified toxin that is no longer harmful but retains immunogenicity.

tumor antigens: Antigens whose expression is associated with tumor cells.

tumor necrosis factor (TNF, also called TNF α): Together with the related cytokine lymphotoxin (TNF β), was originally named for its cytotoxic effect on certain tumor cells, but also has important inflammatory and immunoregulatory functions.

variable (V) gene segments: Genes that rearrange together with *D* (diversity) and *J* (joining) gene segments in order to encode the variable region amino acid sequences of immunoglobulins and T-cell receptors.

vascular addressins: Cell adhesion molecules present on the luminal surface of blood and lymph vessel endothelium recognized by homing molecules that direct leukocytes to tissues with the appropriate "address."

vasoactive amines: Substances including histamine and 5-hydroxytryptamine that increase vascular permeability and smooth muscle contraction.

xenogenic: Genetic differences between species.

xenograft: A tissue or organ graft between individuals of different species.

Index

Note: Page numbers in *italics* refer to figures; entries in **bold** indicate tables.

- ABO blood groups 418–419, *419*
acquired immunity *see* specific acquired immunity; vaccines
acquired immunodeficiency syndrome *see* HIV/AIDS
ACT *see* adoptive cell transfer
activation-induced cell death (AICD) 196, 277–278, 279, 280
activation-induced cytidine deaminase (AID) 92, 111–112
acute phase proteins
 collectins 40–41, *40*
 ficolins 41, *41*
 innate immunity 38–41, **39**
 pentraxins 39–40
acute rejection 436–437, **439**, 441, 449
ADA *see* adenosine deaminase
adaptive immunity 5
 delayed and highly specific nature of 11
 effectors 218–220, 219, 222–224, 248–251, 248, 250
 instigation by innate immunity 45–48
 interdependence with innate immunity 11–12
 levels of immune defense 10, *10*
 lymphoid cells 16–18
 membrane receptors for antigen 113–115, 129
 phylogeny 313
 policing the adaptive immune system 222, 248–251, 248, 250
ADCC *see* antibody-dependent cellular cytotoxicity
addressins 171, *173*, 175–177
adenosine deaminase (ADA) 390–391
adjuvants for vaccines 373–375, **374**
adoptive cell transfer (ACT) 58, 492–493, *492*
adult respiratory distress syndrome 430
adversarial strategies during infection 321–352
 antibodies 326, 329–334, *334*
 bacterial infections 326–338, 327–329, 350
 concepts and definitions 322
 fungal infections 342–344, *344*, 350
 habitat of intracellular bacteria and host defense avoidance 334–338
 healthcare impacts 322, *322*, 338–339
 historical milestones *330*
 host counterattack against bacteria 329–334
 host counterattack against parasites 344–348
 host counterattack against viruses 341–342
 immune protection of mucosal surfaces 332–333, *332*
 inflammatory response 322–326, 336, 350
 local factors 341–342
 opsonization of bacteria 329–332, 331, *332*
 parasitic infections 344–349, 350–352
 prions 349, 352
 serum antibody protection 341
 specific bacterial infections 333–334, 336–338
 toxin neutralization 329
 viral infections 338–342, 339–340, 342–343, 350
aerobic glycolysis 200–201
affinity maturation 92
African swine fever virus (ASFV) 341
age-related macular degeneration (AMD) 383
aging 287–288, 288
AICD *see* activation-induced cell death
AID *see* activation-induced cytidine deaminase
AIDS *see* HIV/AIDS
AIRE *see* autoimmune regulator
alarmins *see* danger-associated molecular patterns
allelic exclusion 307, *308*
allergy and other hypersensitivities 405–434
 adversarial strategies during infection 349
 allergy march *410*
 alloimmune reactions 418–420
 anaphylaxis 407
 Arthus reaction 422–423, *423*
 asthma 410–414, *412*
 atopic allergy 410–412, *410–413*
 autoimmune diseases 519–521
 autoimmune reactions 420–421
 categories of hypersensitivity 405, *405*
 cellular basis of Type IV hypersensitivity 427, *427*
 clinical responses to allergens 410–412
 comparison of Types I–IV hypersensitivity **433**
 concepts and definitions 405
 contact dermatitis 428–429, *429*
 cross-linking of IgE receptors triggers degranulation 407–410, *408*, *409*
 deposition of immune complexes at other sites 425–426
 diagnosis 411, *411*, 415, 426, *426*
 disease resulting from circulating complexes 424–426
 drug reactions 412, *413*, 421
 eczema 411–412, *412*, 414–415
 etiologic and risk factors 415, *416*
 food allergens 412, *413*
 hayfever 410, 414
 historical milestones *407*
 infections 427–428
 inflammatory bowel disease 428
 inflammatory lesions due to locally formed complexes 422–424
 innate hypersensitivity reactions 430–431, 432–433
 mast cells 407–410, **408**
 pathological mechanisms in asthma 412–414
 phylogeny 313
 psoriasis 429
 reactions to inhaled allergens 423
 reactions to resident infections or self antigens 423–424
 sarcoidosis 428
 specific acquired immunity 66, *66*
 tissue damage produced by Type IV reactions 427–430
 treatment 415–418, *417*, 426
 Type I hypersensitivity 356, 407–418, 431–432
 Type II hypersensitivity 356, 418–421, 432
 Type III hypersensitivity 421–426, 432
 Type IV hypersensitivity 314, 426–430, 432
 Type V hypersensitivity 430, 432
 typical allergens **411**
 vaccines 356
 wheat and flare reaction 410, *411*, 415
 allogeneic MHC 440–441, *441*

- allografting 419–420, 436, 454–455, 455
alloimmune reactions 418–420
 $\alpha\beta$ T-cells
 anatomy of the immune response 171
 antigen-specific recognition 156–157, 158–160, 163, 163
 ontogeny 298–299
 regulation of immune response 274–276
ALPS *see* autoimmune lymphoproliferative syndrome
Alzheimer's disease 431
AMD *see* age-related macular degeneration
AMPK 202
anaphylaxis 407, 412
anatomy of the immune response 167–186
 antigens 182–183, 185
 blood and lymphatic systems 171, 174, 174
 bone marrow 168, 174, 180–181, 182
 concepts and definitions 168
 immunologically privileged sites 181–182
 integrin superfamily 175–177, 176
 interdigitating dendritic cells 182–183, 183, 184
 intraepithelial lymphocytes 171, 174
 liver 181
 location of the immune system 168, 168, 184
 lymph nodes 174–180, 179–180, 185
 lymphocyte homing 175–177, 178, 185
 mucosal immunity 169–171, 170–174, 184–185
 organized lymphoid tissue 174–175, 175
 selective expression of MAdCAM-1 170–171, 173
 skin immune system 168–169, 169, 170, 184
 spleen 174–175, 180, 181, 185
ANCA *see* antineutrophil cytoplasmic antibodies
ankylosing spondylitis (AS) 519
antibodies 69–96
 adversarial strategies during infection 326, 329–334, 334, 341, 345–346, 346
 allergy and other hypersensitivities 418–422, 418
 alternative and lectin complement pathways 55, 55, 57
 anatomy of the immune response 180
 antibody footprints 141
 antigen-specific recognition 144–150, 163–164
 classical complement pathway 54–55, 54, 55
 classification 70–72
 class switch recombination 93, 94
 complement activation 79–80, 79, 94
 concepts and definitions 53, 67, 70
 effectors 258, 259
 energetic map of antibody–antigen interface 147
 factors affecting antibody affinity in immunity 261–262, 262
 gene conversion and repertoire diversification 93, 93
 genetics of antibody diversity and function 86–95
 historical milestones 71, 88, 209–210, 330
 human leukocyte Fc receptors 80–84, 81, 82–83
 immunodeficiency 386–387, 400–401, 401
 immunoglobulin class switching 257, 258–260, 259–261
 immunoglobulin G molecule 72–77
 immunoglobulin variable gene segments and loci 87–88, 88
 isotypes, allotypes, and idiotypes 86
 lymphocyte activation 188
 lymphocytes 56, 59
 multivalency in antibody–antigen interactions 146–147, 148
 neonatal Fc receptor 84–85, 84–85
 phagocytosis 55, 57
 phylogeny 313
 recombinase machinery 90, 91
 recombination signal sequences 90, 90
 regulating V(D)J recombination 90–91
 regulation of immune response 273, 274, 276–277, 277
 secretory IgA 85–86, 87
 somatic hypermutation 91–92
 somatic recombination 86–87
 specific acquired immunity 53–56, 53, 62–64, 66–67
 specificity and cross-reactivity of antibodies 148
 structure and the division of labor 70, 70
 structure and function of the immunoglobulin classes 77–86, 77, 94–95
 thermodynamics of antibody–antigen interactions 144–147
 transplantation 441, 442
 tumor immunology 466–467, 484–486
 T–B collaboration for antibody production 209–210
 vaccines 354–357, 355
 V(D)J recombination and combinatorial diversity 88–93, 89, 91–93
 what antibodies *see* 140
antibody-dependent cellular cytotoxicity (ADCC)
 adversarial strategies during infection 333, 349
 allergy and other hypersensitivities 418–420, 418
 human leukocyte Fc receptors 80
 specific acquired immunity 56, 58, 64, 64
 transplantation 441, 442
 tumor immunology 467
antibody-dependent cytotoxicity *see* Type II hypersensitivity
antigenic competition 276, 276
antigenic drift and shift 339–340, 339
antigenic variation 329, 348–349, 348
antigen-independent cytokine therapy 488–489
antigen-presenting cells (APC)
 anatomy of the immune response 168, 182
 autoimmune diseases 508
 effectors 248–250, 264
 innate immunity 46–48, 47
 lymphocyte activation 189–190, 189–191, 196–197
 membrane receptors for antigen 113
 regulation of immune response 274–276
 transplantation 440–441
 tumor immunology 459, 479
antigens
 adaptive immunity 11
 adversarial strategies during infection 339–341, 340, 348–349
 allergy and other hypersensitivities 418–419, 421–424
 anatomy of the immune response 181–182
 antibodies and antigen recognition 53–56, 53, 66–67
 antigen specificity 61–62, 66, 67
 B-cell responses mediated by cytokines 257–258
 clonal selection 56–58, 59, 61
 concepts and definitions 53
 differentiation of lymphocytes 309, 310
 discrimination between different antigens 61
 discrimination between self and nonself 61–62
 effectors 257–267
 immunoglobulin class switching 257, 258–260, 259–261
 lymphocyte activation 203–204, 204, 207–210
 membrane receptors 97–138
 memory cells 262–267
 ontogeny 292, 293, 310
 regulation of immune response 273–276, 273
 transplantation 437–438, 439, 447–448, 448
 tumor antigens 477–483

- tumor immunology 459, 470–471, 471, 477–483, 488–490
vaccines 373–375
see also antigen-specific recognition;
human leukocyte antigen
- antigen-specific recognition 139–166
 $\alpha\beta$ T-cells 156–157, 158–160, 163, 163
amino acid residues in the epitope 141
antibodies 144–150, 163–164
antibody footprints 141
antigens versus immunogens 142–143, 143
B-cell epitopes on protein 143–144, 143, 144
complementarity of binding site 140
complementarity determining regions 141–142, 142, 160–161
concepts and definitions 140
cross-presentation of antigens 154, 155, 164
energetic map of antibody–antigen interface 147
extracellular antigen processing for presentation by MHC II 151–152, 151, 153–154, 163
 $\gamma\delta$ T-cells 159–161
historical milestones 148–149
intracellular antigen processing for presentation by MHC I 150–151, 151, 152, 163
multivalency in antibody–antigen interactions 146–147, 148
peptide-binding grooves 154–156, 156
peptide structure 142
protein–protein interactions 146
specificity and cross-reactivity of antibodies 148
superantigens as T-cell activators 162–163, 163, 165
T-cell recognition of non-protein antigens 158–159, 161–162
ternary complex with MHC, peptide and T-cell receptors 156–157, 158–160, 165
thermodynamics of antibody–antigen interactions 144–147, 164
what antibodies *see* 140
what the T-cell sees 148–150, 150
- antigen-specific tolerance 447–448, 448
antimitotic drugs 523–524
antineutrophil cytoplasmic antibodies (ANCA) 521, 521
antiphospholipid syndrome 513–514
antiretroviral therapy (ART) 399–400
APC *see* antigen-presenting cells
APOBEC3G 399
apoptosis
CD28 co-stimulation 195–196
cytotoxic T-lymphocytes 254–255, 255
innate immunity 6, 6, 42, 44, 48
plasma cell survival and cytokines 248
- APS-1 *see* autoimmune polyendocrine syndrome-1
ART *see* antiretroviral therapy
Arthus reaction 422–423, 423
AS *see* ankylosing spondylitis
ASFV *see* African swine fever virus
Aspergillus fumigatus 343
asthma 410–414, 412
ataxia telangiectasia 389
atherosclerotic plaques 521–522
atopic allergy 410–412, 410–413
attenuated vaccines 358–362, 361
autoantibodies 62, 500, 513–516, 522
autoantigens 500, 508–510
autografting 436
autoimmune diseases 499–528
aberrant expression of MHC class II 511–513
autoantigens 500, 508–510, 516–519
classification criteria 500
concepts and definitions 500
cytokine imbalance 513, 514
discovery of thyroid autoimmunity 501–502
environmental factors 506–507, 526–527
genetic causes 503–505, 503
historical milestones 501–502
hormonal influences 505–506, 505, 506
idiotype bypass mechanisms 510, 512
measurement of autoantibodies 522, 527–528
mechanisms in autoimmune disease 507–513, 527
molecular mimicry of T-cell epitopes 509–510, 510
other diseases with autoimmune activity 521–522, 527
overlap of autoimmune disorders 501
pathogenic effects of autoantibody 513–516, 527
pathogenic effects of autoantigens 516–519, 527
piggy-back T-cell epitopes and epitope spread 510, 511, 516
polyclonal activation 510–511
regulatory defects 511, 512–513
specific acquired immunity 66
spectrum of autoimmune diseases 500–501, 501, 503, 526
T-cell help for autoantigen-specific B-cells 509–510
T-cell-mediated hypersensitivity as pathogenic factor 519–521, 527
tolerance is not absolute 508
treatment 522–526, 523, 528
autoimmune hemolytic anemia 420–421, 513
autoimmune lymphoproliferative syndrome (ALPS) 389
- autoimmune polyendocrine syndrome-1 (APS-1) 389
autoimmune reactions 420–421
autoimmune regulator (AIRE) gene 302, 303
autoinflammatory disorders 381, 382
AZT *see* zidovudine
- bacille Calmette–Guérin (BCG) 360
bacterial capsules 333
bacterial infections
adversarial strategies during infection 326–338
antigenic variation 329
autoimmune diseases 507, 507
cell-mediated immunity 335–336
evading complement 326–329, 328, 329, 333–334
evading killing by macrophages 329, 329, 334–338, 335–337
evading phagocytosis 326, 327, 334–335
habitat of intracellular bacteria and host defense avoidance 334–338
host counterattack against bacteria 329–334
vaccines 362
bacterial lysis 34–38
bacterial pyogenic toxins 162
bare lymphocyte syndrome 388–389
basophils 15–16, 17
B-cell receptors (BCR)
activating and inhibitory NK receptors 115–116
B-cell co-receptor complex 212–213, 212
clustering leads to activation 188–189
co-receptor complex 102, 102
damping down B-cell activation 214
dynamic interactions at the BCR synapse 214, 215
membrane protein complexation 99–101, 101
membrane receptors for antigen 98–99, 98
microcluster formation 101–102
nature of B-cell activation 210–214
phylogeny 313
specific acquired immunity 60
surface transmembrane immunoglobulin 99–101, 100
BCG *see* bacille Calmette–Guérin
Bcl-2 family 278
BCR *see* B-cell receptors
bioterrorism 372
birth and death evolution model 122, 123
blood
allergy and other hypersensitivities 418–419, 419, 420
anatomy of the immune response 171, 174, 174
tumor immunology 486

- B-lymphocytes
 adaptive immunity 11, 13, 16–18, 18
 allelic exclusion 307, 308
 anatomy of the immune response
 168–169, 178–180, 183
 antigen-specific recognition 143–144,
 143, 144
 autoimmune diseases 509–511, 509
 B-1 and B-2 cells as distinct
 populations 305, 307
 B-cell co-receptor complex 212–213, 212
 Cd19/Cd28 co-stimulation 212–213
 concepts and definitions 188
 cytokine mediation of B-cell
 responses 255–258
 damping down B-cell activation 214
 development of B-cell specificity 305–
 307, 308
 differentiation in fetal liver and bone
 marrow 304–305
 dynamic interactions at the BCR
 synapse 214, 215
 germinal centers 256–257, 256
 historical milestones 209–210
 immunodeficiency 386–387, **386**,
 387, 389
 immunoglobulin class switching 257,
 258–260, 259–261
 immunological tolerance 307–309,
 309–310
 light and dark zones within the GC 257,
 258
 lymphocyte activation 187–189, 207–216
 nature of B-cell activation 210–214, 216
 ontogeny 304–309
 phylogeny 314
 plasma cell migration and chemokine
 expression 257–258
 plasma cell survival and cytokines 258
 regulation of immune response 277, 278
 sequence of Ig gene rearrangements
 305–306, 308
 specific acquired immunity 53, 56, 66
 superantigens 163
 T-helper cell co-stimulation 213–214, 213
 thymus-dependent antigens 208–209,
 209–211, 216
 transplantation 439
 type 1 thymus-independent
 antigens 207–208, 208, 216
 type 2 thymus-independent antigens 208,
 208, 216
 T–B collaboration for antibody
 production 208, 209–210
 vaccines 357
- bone marrow
 anatomy of the immune response 168,
 174, 180, 182
 innate immunity 14, 15
 ontogeny 304–305
- bone marrow stem cells 295, 449–450
 bone marrow stromal antigen 2 (BST2) 399
 bone marrow stromal cells 292
 Boon, Thierry 481
 B-Raf 474–475, 475
 Brown, James Barrett 437
 BST2 *see* bone marrow stromal antigen 2
 bystander tolerance 526, 526
- C3 convertase 54–55, 55, 57, 59
 calcineurin 194–195
 calmodulin 194–195
 calnexin 151
 calreticulin 151
 cancer *see* tumor immunology
Candida albicans 343–344
 CAPS *see* cryopyrin-associated periodic
 syndrome
 CAR *see* chimeric antigen receptor
 carbohydrate structure 482
 carbohydrate vaccines 363, 364
 carcinomas 463
 caspase 42, 254, 255
 Cbl family proteins 205
 CCR5 397
 CCR7/CCR9 266, 266, 295–298
 CD1 family 158, 161–162
 CD3 complex 106–108, 107, 191, 192
 CD16 Fc receptors 119
 CD19 co-stimulation 212–213
 CD28 co-stimulation 195–197, 205, 213,
 279, 280
 CD40 491, 491
 CD40L–CD40 interaction 255
 CD44 265–266, 265, 298, 483
 CD94 receptors 117
 CD antigens 292, **293**
 CDR *see* complementarity determining regions
 cecropins 313
 celiac disease 430, 515–516
 cell-mediated hypersensitivity *see* Type IV
 hypersensitivity
 cell-mediated immunity (CMI)
 adversarial strategies during
 infection 335–336, 341–342,
 342–343, 346–348, 347
 cytotoxic T-lymphocytes 251–255,
 251–255
 immunodeficiency 379, 389
 specific acquired immunity 62–68, 67
 tumor immunology 465
 cell polarization 243–244, 243, 247–248
 cellular stress 119
 central supramolecular activation complex
 (cSMAC) 207, 214
 centroblasts 257
 centrotypes 257
 CGD *see* chronic granulomatous disease
 checkpoint blockade immunotherapy
 487–488, 487
- Chédiak–Higashi disease 381, 391
 chemokines
 additional functions 233–234
 adversarial strategies during infection 325
 agonist and antagonist action 233
 cell surface receptors 234
 diversity of chemokine family 230,
231–232, 232, 233
 effectors 229–234, 257–258
 functional classification 230, 230
 homeostatic chemokines 230
 immunodeficiency 397
 inflammatory chemokines 230, 232–233
 innate immunity 8, 8, 10
 plasma cell migration 257–258
 tumor immunology 474–477, 486
- chemotaxis 34
 chimeric antigen receptor (CAR)
 therapy 493–494
 chronic granuloma 428
 chronic granulomatous disease (CGD) 379,
 380, 381
 chronic immune activation 5
 chronic inflammation 326, 476–477, 476
 chronic rejection 436–437, **439**, 441
 CLA *see* X-linked agammaglobulinemia
 class switch recombination (CSR) 93, 94
 clonal anergy 304, 307–309
 clonal deletion 307–309
 clonal expansion 11
 clonal selection 56–58, 59, 61
 CLR *see* C-type lectin receptors
c-myc gene 461
 Coley's toxin 489
 collectins 40–41, 40, 329–331
 combinatorial diversity
 antibodies 88–90, 89, 92
 membrane receptors for antigen 108–111,
 109
- common variable immunodeficiency (CVID)
 386–387
- complement
 activation 35
 adversarial strategies during infection
 326–332, 328, 329, 333–334
 alternative and lectin pathways 55, 55, 57
 antibody activation of 79–80, 79, 94
 classical pathway 54–55, 54, 55
 defensive biological functions 37–38, 38
 immunodeficiency 382–384, **384**
 innate immunity 19–20, 34–38, 35
 phagocytosis and bacterial lysis 34–38
 post-C3 pathway 37, 37
 regulation of immune response 276–277,
 277
 slow spontaneous cleavage of C3 35, 35
 specific acquired immunity 53, 54–55, 54
 stabilization of C3 convertase 36
 tight control of C3b levels 35–36, 36
 transplantation 449

- complementarity determining regions (CDR)
 antigen-specific recognition 141–142, 142, 160–161
 immunoglobulin G molecule 72, 75, 76
 membrane receptors for antigen 103, 112, 113–115, 113
- concomitant immunity 344–345
- congenital complete heart block 516
- contact dermatitis 428–429, 429
- control proteins 382–384, 385, 386
- Coomb's test 419, 420
- co-receptor complex 102, 102, 104, 105
- corticosteroids 417, 418
- co-stimulatory blockade 447, 448
- C-reactive protein (CRP) 39–40, 40
- Crohn's disease 428
- cross-reactivity 148
- CRP *see* C-reactive protein
- cryopyrin-associated periodic syndrome (CAPS) 381
- cryptic epitopes 508
- cSMAC *see* central supramolecular activation complex
- CSR *see* class switch recombination
- CTLA-4 *see* cytotoxic T-lymphocyte antigen-4
- C-type lectin receptors (CTLR) 24, 134–135
- cutaneous basophil hypersensitivity 427
- CVID *see* common variable immunodeficiency
- CXCR4 397, 486
- cytokines
 activated T-cell proliferation in response to 242–247, 242
 adversarial strategies during infection 336–337, 336, 342
 allergy and other hypersensitivities 406–407, 413–415, 427–429
 alternative functions 229
 autoimmune diseases 513, 514
 cell surface receptors 234
 dendritic cells 223–224
 effectors 220, 223–229, 224, 234–247, 255–258, 266–267, 267
 gene expression 225
 generation and function of effectors in adaptive immune system 223–224, 223
 hierarchical cascades 229, 229
 immunodeficiency 379, 381, 384–385, 390
 innate immunity 8, 8, 10, 26
 intercellular messengers 224–229, 225
 lymphocyte activation 188, 196–197, 199–202
 macrophage polarization 224
 mechanisms for fine-tuning activities of 240–242
 mediation of B-cell responses 255–258
 memory cells 266–267, 267
- network interactions 240, 241
 origin and function 226–228
 plasma cell survival 258
 pleiotropy 240, 240
 signal transduction cascades 234–240
 specific acquired immunity 63, 64
 specificity 236–237
 structure 225, 228
 transient and short range action 225–226
 tumor immunology 474–477, 486, 488–489
- cytokine signaling pathway 390
- cytosolic DNA sensors 25–26
- cytotoxicity
 allergy and other hypersensitivities 418–421, 418
 effectors 250–251
 membrane receptors for antigen 103, 117
see also antibody-dependent cellular cytotoxicity
- cytotoxic T-lymphocyte antigen-4 (CTLA-4)
 autoimmune diseases 505
 downregulation of T-cell responses 203–204, 204
 effectors 248–250
 regulation of immune response 283–284
 transplantation 446
 tumor immunology 459, 466, 468–470, 469, 483, 487, 491
- cytotoxic T-lymphocytes (CTL)
 adversarial strategies during infection 342
 antigen-specific recognition 148–150, 150
 apoptotic cell clearance through phagocytosis 254–255, 255
 autoimmune diseases 519–520
 caspase activation and target cell death 254, 255
 cell-mediated immunity 251–255, 251–255
 Fas/Fas ligand pathway 252, 253–254, 254
 generation of 251, 251
 granulysin-dependent pathway 255
 immunodeficiency 394, 400–402
 innate immunity 9, 43
 lymphocyte activation 189, 189, 196–199
 mechanism of cytotoxicity 251–252, 252
 perforin/granzyme-dependent pathway 252–253, 252, 253
 regulation of immune response 282–283, 282, 283
 specific acquired immunity 62–63
 transplantation 440–441, 447–448
 tumor immunology 465–466, 481–482, 492–493
 vaccines 357
- danger-associated molecular patterns (DAMP)
 effectors 219–221, 223–224
- innate immunity 6, 6, 7–8, 26–29, 47
 lymphocyte activation 191
 tumor immunology 466, 466, 468, 472, 472, 474
- DC *see* dendritic cells
- death domain (DD) 134
- death-inducing signaling complex (DISC) 278, 279
- death receptor pathway 42, 43–44
- dectin-1 135, 135
- defensins 32–33, 33, 38
- deficiency of the interleukin-1 receptor antagonist (DIRA) 381
- delayed-type hypersensitivity *see* Type IV hypersensitivity
- dendritic cells (DC)
 anatomy of the immune response 182–183
 effectors 219–220, 221, 223–224, 248–251, 255
 innate immunity 15, 16, 46–48, 46–48
 lymphocyte activation 189, 190, 191, 214
 tumor immunology 466, 494–495, 495
- desensitization immunotherapy 415, 417
- diapedesis
 adversarial strategies during infection 324, 324
 anatomy of the immune response 177
 innate immunity 19–20
- diet and nutrition 287, 506, 515–516
- differentiation
 antigen-(in)dependence in lymphocytes 309, 310
 B-cells in fetal liver and bone marrow 304–305
 innate immunity 7, 10
 phylogeny of B-cell and T-cell lineages 314, 314
 surface marker changes 295–298, 296, 297
- DiGeorge syndrome 387–388
- dinitrophenyl (DNP) antibodies 75–77, 76
- DIRA *see* deficiency of the interleukin-1 receptor antagonist
- DISC *see* death-inducing signaling complex
- disease-modifying anti-rheumatic drugs (DMARD) 522–523
- disseminated intravascular coagulation 430
- DMARD *see* disease-modifying anti-rheumatic drugs
- DN *see* double-negative
- DNA damage
 antibodies 90
 membrane receptors for antigen 119
 tumor immunology 460–461, 462, 473, 476–477, 476
- DNA vaccines 363–365, 365
- Doherty, Peter 148–149
- double-negative (DN) cells 295–297
- double-positive (DP) cells 297
- DP *see* double-positive

- drug immunoconjugates 486
drug-induced lupus 506
drug reactions 412, 413, 421
DTH *see* Type IV hypersensitivity
- EAE *see* experimental allergic encephalomyelitis
- EBV *see* Epstein–Barr virus
- eczema 411–412, 412, 414–415
- Edelman, Gerald 71
- effector caspases 42
- effectors 218–271
activated T-cell proliferation in response to cytokines 242–247, 242, 244–246, 268
adversarial strategies during infection 341–342, 348
allergy and other hypersensitivities 417
alternative functions of cytokines 229
antibody synthesis 258, 259, 269
B-cell responses mediated by cytokines 255–258, 269
cell surface receptors 234
chemokines 229–234, 257–258, 267–268
concepts and definitions 218–219
cytokines 220, 223–229, 224, 234–247, 255–258, 266–268, 267
cytotoxic T-lymphocytes in cell-mediated immunity 251–255, 251–255, 269
factors affecting antibody affinity in immunity 261–262, 262, 270
gene expression 225, 268
generation and function in adaptive immune system 223–224, 223
hierarchical cascades 229, 229
immunoglobulin class switching 257, 258–260, 259–261, 269
innate and adaptive immunity 218–220, 219, 222–224
innate immunity 10, 218–221, 219
innate immunity and T-helper cell response 247–248
intercellular messengers 224–229, 225, 268
macrophage polarization 224
mechanisms for fine-tuning activities of cytokines 240–242
mechanisms of immunity 220–223, 267
memory cells 262–267, 270
origin and function of cytokines **226–228**
policing adaptive immunity 222, 248–251, 248, 250, 269
signal transduction cascades 234–240
structure of cytokines 225, 228
vaccines 357
- Ehrlich, Paul 61
- elephantiasis 424
- endoplasmic reticulum-associated protein degradation (ERAD) 150
- endoplasmic reticulum resident aminopeptidases (ERAP-1/2) 150–151
- eosinophils
allergy and other hypersensitivities 411, 413–414
innate immunity 15–16, 17, 45
- epigenetic control 199–200, 200
- epitope spread 510, 511
- Epstein–Barr virus (EBV) 341, 471, 490
- ERAD *see* endoplasmic reticulum-associated protein degradation
- ERAP *see* endoplasmic reticulum resident aminopeptidases
- erythema nodosum leprosum 424, 424
- E-selectins 20, 325
- exotoxins 329
- experimental allergic encephalomyelitis (EAE)
model 501, 520–521, 525–526, 525
- extravasation 20, 22
- extrinsic allergic alveolitis 423
- Fab *see* fragment antigen binding
- familial Mediterranean fever 381
- Farmer's lung 423
- Fas/Fas ligand pathway
cytotoxic T-lymphocytes 252, 253–254, 254
lymphocyte activation 205
memory cells 262, 265–266, 265
- Fc *see* fragment crystallizable
- FDC *see* follicular dendritic cells
- Fenner, Frank 301
- fibrin clots 325
- fibroblastic reticular cells (FRC) 178
- ficolins 41, 41
- FLIP 278, 280
- follicular B-cells 207
- follicular dendritic cells (FDC)
adversarial strategies during infection 349
anatomy of the immune response 177, 183
effectors 256–257, 256, 264
- food allergens 412, 413
- Foxp3 198, 282–283, 282, 283
- fragment antigen binding (Fab) arm 70, 71, 74–77, 75
- fragment crystallizable (Fc) unit
human leukocyte Fc receptors 80–84, **81**, 82
neonatal Fc receptor 84–85, 84–85
structure and function 70, 71, 75, 76, 78
- FRC *see* fibroblastic reticular cells
- fulminant pneumonitis 381
- fungal infections
adversarial strategies during infection 342–344, 344
immunodeficiency 390–391
membrane receptors 134–135
- GAD *see* glutamic acid decarboxylase
- $\gamma\delta$ T-cells 159–161, 171, 299
- GATA3 198–200
- GBM *see* glomerular basement membrane
- GEF *see* guanine-nucleotide exchange factors
- gender 287–288, 288
- gene conversion 93, 93, 125
- gene expression
effectors 225
immunodeficiency 396, 396, 398–399
lymphocyte activation 196–199, 197
tumor immunology 482
- gene therapy 391, 392
- genetics
allelic exclusion 307, 308
antibodies 86–95
autoimmune diseases 503–505, **503**
class switch recombination 93, 94
gene conversion and repertoire diversification 93, 93
immunodeficiency 388–391
immunoglobulin variable gene segments and loci 87–88, 88
interchain amplification of diversity 111
major histocompatibility complex 122–127
membrane receptors for antigen 105–106, 106, 108–113, **108**, 122–127
playing with the junctions 109, 109
RAG recombinase 111
receptor editing 109–111, 110
recombinase machinery 90, 91
recombination signal sequences 90, 90
regulating V(D)J recombination 90–91
regulation of immune response 273–276, 274–276
sequence of Ig gene rearrangements 305–306, 308
somatic hypermutation 91–92, 111–113, 112
somatic recombination 86–87
transplantation 437–438, 439
tumor immunology 460–464, 461
- V(D)J recombination and combinatorial diversity 88–93, 89, 91–93, 108–109, 109
- germinal centers
B-cell responses mediated by chemokines 256–257, 256
light and dark zones 257, 258
T follicular helper cells 245–246
- giant cell arteritis 521
- glomerular basement membrane (GBM) 516
- glomerulonephritis 420–421, 421, 424–425, 424
- glucans 135, 135
- glucocorticoids 285–286, 286
- glutamic acid decarboxylase (GAD) 519–520
- glycoconjugates 363, 364
- glycolipid 158, 161–162
- glycoproteins 396–399, 401
- GM-CSF *see* granulocyte–macrophage colony-stimulating factor

- Goodpasture's syndrome 420–421, 421, 516
 Gorer, Peter 120
 graft-versus-host (GVH) reaction 439, 440, 453
 granule-dependent pathway 43
 granulocytes 15–16, 17
 granulocyte–macrophage colony-stimulating factor (GM-CSF) 237, 237, 238, 489, 491
 granulysin-dependent pathway 255
 granzymes 43
 Grave's disease 514
 Gross, Ludwig 296
 growth factors 464
 guanine-nucleotide exchange factors (GEF) 194
 Guillain–Barré syndrome 514
 gut-associated immunity 169–170, 172
 GVH *see* graft-versus-host
- H-2 haplotype 125, 126, **127**, **274**
 H-2M3 157–158
 HA *see* hemagglutinin
 Haflick limit 464
 haplotype restriction 148–150
 Hashimoto's disease 500, 514, 519
 HATA *see* human antitoxin antibody
 hayfever 410, 414
 Hayflick limit 266–267
 HBV *see* hepatitis B virus
 heat-shock proteins (hsp) 154
 helminths 45
 helper T-cells *see* T-helper cells
 hemagglutinin (HA) 144, 144, 339
 hematopoietin 234
 hematopoiesis 15, 240, 240
 hematopoietic malignancies 463
 hematopoietic stem cells (HSC)
 anatomy of the immune response 168
 innate immunity 14, 15
 ontogeny 292, 294
 specific acquired immunity 59
 transplantation 452–453
 hemolytic anemia 420–421, 513
 hemolytic disease of the newborn 419, 420
 hepatitis B virus (HBV) 362, 490
 hepatitis C virus (HCV) 366
 herd immunity 357, 357
 hereditary angioedema 383–384, 386
 herpes simplex virus (HSV) 341
 HEV *see* high-walled endothelium of the postcapillary venules
 HIDS *see* hyper-IgD syndrome
 HIES *see* hyper-IgE syndrome
 HIF *see* hypoxia-inducible factor
 high-walled endothelium of the postcapillary venules (HEV) 173, 175–177, 175
 HIMS *see* hyper-IgM syndrome
 histamine 332–333
 histamine H1-receptor antagonists 417
- histones 199
Histoplasma capsulatum 343–344
 HIV/AIDS
 adversarial strategies during infection 338–339
 clinical course of disease 393–395, 395
 evolution of HIV 393, 394
 history and epidemiology 392–393, 393
 HIV-1 genome 396, 396
 HIV-1 therapy 399–400
 HIV-1 vaccines 400–402, 400, 401
 immunodeficiency 379, 391, 392–402
 life cycle of HIV-1 396–399, 397
 opportunistic infections 394–395
 vaccines 366, 368
 HLA *see* human leukocyte antigen
 homeostatic chemokines 230
 homology domains 72, 73
 hormonal influences 505–506, 505, 506
 house dust mites 410
 housekeeping proteasome 150–151
 HPV *see* human papillomavirus
 HSC *see* hematopoietic stem cells
 hsp *see* heat-shock proteins
 HSV *see* herpes simplex virus
 human antitoxin antibody (HATA) 486
 human epidermal growth factor receptor-2 (HER2) 478–479, 478, 483–485
 human immunodeficiency virus *see* HIV/AIDS
 human leukocyte antigen (HLA)
 antigen-specific recognition 149
 autoimmune diseases 504, 504, **504**, 519
 immunodeficiency 395
 membrane receptors for antigen 127–129
 transplantation 442–445, 444
 tumor immunology 470–471
 human papillomavirus (HPV) 489
 humoral immunity
 acute phase proteins 38–41
 adversarial strategies during infection 341, 345–346, 346
 innate immunity 38–42
 interferon inhibition of viral replication 41–42
 microbicidal factors in secretions 38
 specific acquired immunity 56–58
 hyperacute rejection 436–437, **439**, 441, 449, 449
 hyper-IgD syndrome (HIDS) 381
 hyper-IgE syndrome (HIES) 389
 hyper-IgM syndrome (HIMS) 389
 hypersensitivity *see* allergy and other hypersensitivities
 hyperthyroidism 514
 hypothyroidism 514
 hypoxia-inducible factor (HIF) 202
- IBD *see* inflammatory bowel disease
 ICAM *see* intercellular cell adhesion molecule
- IDC *see* interdigitating dendritic cells
 idiopathic pulmonary fibrosis 431
 idiopathic thrombocytopenic purpura (ITP) 420, 513
 idiotype bypass mechanisms 510, 512
 idiotype networks 277, 278
 IDO *see* indoleamine 2,3-dioxygenase
 IFN *see* interferons
 Ig *see* immunoglobulin(s)
 IgE-mediated mast cell degranulation *see* Type I hypersensitivity
 IKK *see* inhibitor of nuclear factor κ B
 IL1R-associated kinase-4 (IRAK-4) 133–134, 379
 IL *see* interleukins
 immune checkpoint therapy 487–488, 487
 immune complex-mediated hypersensitivity *see* Type-III hypersensitivity
 immunodeficiency 378–404
 antibody isotypes affected by deficiencies 386–387
 arrest of early T-cell development 388–389
 autoinflammatory disorders 381, 382
 complement system deficiencies 382–384, **384**
 concepts and definitions 379
 control protein defects 382–384, 385, 386
 cytokine and cytokine receptor deficiencies 384–385
 defective thymic development 387–388
 diagnosis of primary immunodeficiencies 390–391
 dysfunctional T-cell–B-cell collaboration 389
 gene therapy 391, 392
 HIV/AIDS 379, 391, 392–403
 lymphoid cells 386, 387
 overactive immune response caused by 389
 pattern recognition receptors 379
 phagocytic cell defects 379–381, 380, **380**, 381
 primary B-cell deficiency 386–387, **386**, 387, 402
 primary immunodeficiency affecting cells of innate response 379, 382, 383, 402
 primary T-cell deficiency 387–389, **388**, 402
 replacing missing components 391
 secondary immunodeficiencies 379, 391–392, 403
 severe combined immunodeficiency 389–391, 390, 403
 transient hypogammaglobulinemia of infancy 387
 treatment of primary immunodeficiencies 391
 vaccines 400–402, 400, 401
 X-linked agammaglobulinemia 386

- immunoediting 459, 470–471, 471
 immunogenetics 273–276, 274–276
 immunogenicity 142–143, 143
 immunoglobulin A (IgA)
 adversarial strategies during
 infection 332–334, 332
 Fc fragment 79, 80–82, 83
 immunodeficiency 386–387, 389
 secretory IgA 85–86, 87
 structure and function 70–71, 77–86,
 77, 78
 vaccines 356
 immunoglobulin D (IgD)
 immunodeficiency 381, 389
 membrane receptors for antigen 99–100,
 100
 structure and function 70–71, 77–86,
 77, 78
 immunoglobulin E (IgE)
 adversarial strategies during
 infection 332–333, 332
 allergy and other hypersensitivities 406,
 407–418, 408, 409
 Fc fragment 79, 80–82, 83
 immunodeficiency 389
 structure and function 70–71, 77–86, 77, 78
 immunoglobulin G (IgG)
 adversarial strategies during
 infection 331, 333
 allergy and other hypersensitivities 406, 429
 amino acid variability 75
 antibody combining site 75, 76
 antigen-specific recognition 146–147, 147
 autoimmune diseases 511, 514, 517–518
 B-1 and B-2 cells as distinct
 populations 305, 307
 Fab fragment 74–75, 75
 Fc fragment 75, 76, 78, 80–83, 83–85
 flexibility 72, 74
 four-chain structure–72, 73
 hinge region and IgG subclasses 75–77, 76
 homology domains 72, 73
 human IgG molecule 74
 immunodeficiency 386–387, 389
 immunoglobulin fold 74
 neonatal Fc receptor, antibodies 84–85, 84
 neonatal immunity 311–312
 regulation of immune response 276–277
 specific acquired immunity 53
 structure and function 70–86, 77, 78
 vaccines 356
 immunoglobulin M (IgM)
 allergy and other hypersensitivities 406,
 428–429
 antigen-specific recognition 147
 autoimmune diseases 511, 517–518
 B-1 and B-2 cells as distinct
 populations 305, 307
 complement activation 79–80, 79
 immunodeficiency 386–387, 389
 membrane receptors for antigen 99–100,
 100
 neonatal immunity 311–312
 regulation of immune response 276–277
 specific acquired immunity 53
 structure and function 70–71, 77–86, 77, 78
 sequence of Ig gene rearrangements
 305–306, 308
 immunologically privileged sites 181–182
 immunological memory
 adaptive immunity 5, 11
 innate immunity 5
 specific acquired immunity 58, 60, 62, 67
 immunological synapse 190, 205–207, 207
 immunological tolerance
 B-lymphocytes 307–309, 309–310
 clonal deletion and clonal anergy 304,
 307–309
 communication and responsiveness 304, 304
 historical milestones 301
 induction
 to avoid self-reactivity 300–301
 intrathymic clonal deletion 302, 303
 positive or negative selection in the
 thymus 302–304
 self-tolerance induction in the
 thymus 301–302, 302
 T-lymphocytes 300–304, 309, 309–310
 immunoneuroendocrine networks
 285–287, 286
 immunopathology 66, 66
 immunoproteasome 151
 immunoreceptor tyrosine-based activation
 motifs (ITAM)
 antibodies 80
 lymphocyte activation 189, 191, 192,
 210–211
 membrane receptors for antigen 101,
 101, 107–108, 116, 118, 134–135
 immunoreceptor tyrosine-based inhibition
 motifs (ITIM)
 antibodies 80
 lymphocyte activation 214
 membrane receptors for antigen 116,
 118, 134–135
 regulation of immune response 277,
 277, 280
 immunosenescence 288
 immunostimulation 373
 immunosuppression 249, 445–448, 445, 447
 immunosurveillance 465, 467–468,
 470–471
 immunotoxin conjugates 486
 indoleamine 2,3-dioxygenase (IDO) 470
 induced-self recognition 119
 inducible nitric oxide synthase (iNOS) 32
 inducible Tregs (iTregs) 283, 284
 induction therapy 445
 infertility 516
 inflammasome 25–26
 inflammatory bowel disease (IBD) 428
 inflammatory response
 adversarial strategies during
 infection 322–326, 336
 allergy and other hypersensitivities 418,
 421–426
 anatomy of the immune response 169
 antibodies 80
 chemokines 230, 232–233
 chronic inflammation 326
 cytokines 239–240
 initiation of acute inflammatory
 response 323–325, 324
 innate immunity 19, 20
 leukocytes binding to endothelial cells 323
 lymphocyte activation 201–202
 mediators of inflammation 322–323, 323
 ongoing inflammatory process 325–326
 regulation and resolution of 326
 specific acquired immunity 65, 66
 T-helper cells 245
 transplantation 446–447
 tumor immunology 471–477, 472, 486
 influenza viruses 338–339, 339
 inhalants 417
 inheritance 126, 127
 inhibitor of nuclear factor κ B (IKK) 237–239
 iNKT *see* invariant natural killer T-cells
 innate hypersensitivity reactions 430–431
 innate immunity 3–51
 adversarial strategies during infection 351
 beginnings of an immune
 response 18–22, 49
 cells of the immune system 12–18,
 13–14, 16–19, 49
 complement facilitated phagocytosis and
 bacterial lysis 34–38, 50
 concepts and definitions 3
 effectors 218–221, 219, 247–248
 external barriers against infection 10, 12,
 12, 49
 historical milestones 13–14
 humoral mechanisms 38–42, 50
 immediate and broad acting nature of 11
 immunodeficiency 382, 383
 infectious agents 3, 8–9
 instigation of adaptive immunity 45–48, 50
 interdependence with adaptive
 immunity 11–12
 knowing when to make an immune
 response 4–6
 large parasites 45, 50
 levels of immune defense 10, 10, 49
 membrane receptors for antigen 113–115
 messenger proteins 7–8, 8

- natural killer cells and virally infected cells 42–45, 50
- pattern recognition receptors 4, 5, 7–12, 8, 19, 22–29
- phagocytic cells that engulf and kill microorganisms 29–30, 50
- phagocytic killing mechanisms 30–34
- proportionality of response to infectious threat 5–6
- recognition and elimination of foreign entities 4–5, 48
- specificity of response to infection type 8–11, 49
- summary 48–50
- T-helper cell response 247–248
- tissue damage and immune response 6, 6
- types of immune response 9–10
- see also* adaptive immunity
- iNOS *see* inducible nitric oxide synthase
- integrins
- anatomy of the immune response 175–177, **176**
- immunodeficiency 381
- innate immunity 21
- lymphocyte activation 189–191, *191*, 207, 214
- phylogeny 316
- intercellular cell adhesion molecule (ICAM)
- adversarial strategies during infection 340
- anatomy of the immune response 177
- innate immunity 21
- lymphocyte activation 189–191, 214
- phylogeny 314–316
- interchain amplification 111
- interdigitating dendritic cells (IDC) 182–183, *183*, *184*
- interferons (IFN)
- adversarial strategies during infection 336–338, *341–343*, *346–347*
- allergy and other hypersensitivities 429
- antigen-specific recognition 151
- autoimmune diseases 513, *514*, *522–526*
- effectors 220, **227**, 234, 244, 247
- immunodeficiency 379, 381
- innate immunity 26, 41–42, 44–45, *45*
- lymphocyte activation 198
- membrane receptors for antigen 115
- regulation of immune response 286–287
- specific acquired immunity 63–64
- transplantation 441, *442*, 453
- tumor immunology 488–489
- interleukins (IL)
- allergy and other hypersensitivities 406–407, 413–415, *427–429*
- autoimmune diseases 521–522, *524–525*
- effectors 220, **226–227**, 228–229, 237, 240–250, 255, 266
- immunodeficiency 381, 384–385, 390
- innate immunity 8, 26–29
- lymphocyte activation 196–198
- membrane receptors for antigen 129
- ontogeny 305
- regulation of immune response 281, 284–285, 287
- transplantation 446–447, 453
- tumor immunology 471, *474–476*, 488
- intestinal immunity 170–171, *173*, *174*
- intraepithelial lymphocytes (IEL) 171, *174*
- intrathymic clonal deletion 302, *303*
- intravenous immunoglobulin (IVIg) 356
- invariant natural killer T-cells (iNKT)
- antigen-specific recognition 158–159
- membrane receptors for antigen 99, 113–115, *113*, *114*
- IPEX syndrome 389
- IRAK-4 *see* IL1R-associated kinase-4
- islet cells 453
- isografting 436
- ITAM *see* immunoreceptor tyrosine-based activation motifs
- ITIM *see* immunoreceptor tyrosine-based inhibition motifs
- ITP *see* idiopathic thrombocytopenic purpura
- iTregs *see* inducible Tregs
- IVIg *see* intravenous immunoglobulin
- JAK–STAT pathway 235–237, *235*, 242
- JAM-1 *see* junctional adhesion molecule-1
- Jenner, Edward 354–355
- junctional adhesion molecule-1 (JAM-1) 177
- junctional diversity 90, 92
- keratinocytes 168–169
- killer immunoglobulin-like receptors (KIR) 116–117, *118*
- Kitasato, Shibasaburo 330
- LAD *see* leukocyte adhesion deficiency
- Lambert–Eaton syndrome 514
- LAMP *see* lysosomal-associated membrane proteins
- LAT *see* linker for activation of T-cells
- LATS *see* long-acting thyroid stimulator
- LCM *see* lymphocytic choriomeningitis
- lectin 55, 55
- Leishmania* spp. 346–347
- leucine-rich repeat (LRR) proteins 129–130
- leukocyte adhesion deficiency (LAD) 381, 391
- leukocytes
- adversarial strategies during infection 323
- anatomy of the immune response 168
- antibodies and human leukocyte Fc receptors 80–84
- leukotriene receptor antagonists 418
- LFA-1 integrin 177, 189–190, *191*, 207, 214
- LFA-3 integrin 191
- limulin 313
- linker for activation of T-cells (LAT) 192
- lipid 158, *161–162*, 201
- lipid rafts 191
- lipopolysaccharide (LPS)
- adversarial strategies during infection 324–325, 329
- allergy and other hypersensitivities 430
- membrane receptors for antigen 130–132, *131*
- lipoprotein 158, *161–162*
- Listeria monocytogenes* 336–337, *337*
- live attenuated vaccines 358–362, *361*
- liver 181
- long-acting β_2 -agonists 417–418
- long-acting thyroid stimulator (LATS) 501
- LPS *see* lipopolysaccharide
- LRR *see* leucine-rich repeat
- Ly49 receptors 116, *118*
- lymphatic system 171, 174, *174*
- lymph nodes
- anatomy of the immune response 174–180, *179–180*
- B-cell areas 178–180
- lymphocyte homing 175–177
- T-cell areas 180
- lymphocytes
- adversarial strategies during infection 325–326
- antigen-dependent and -independent differentiation 309, *310*
- homing to other tissues 177
- immunodeficiency 390
- integrin superfamily 175–177, **176**
- lymphocyte homing 175–177
- naive lymphocytes home to lymph nodes 175, 177
- passage through the HEV 177, *178*
- regulation of immune response 273–276
- specific acquired immunity 56, 59, 66
- see also* B-lymphocytes; T-lymphocytes
- lymphocytic choriomeningitis (LCM) virus 304, *304*
- lymphoid cells
- immunodeficiency 386, *387*
- innate immunity 12–13, *14*, 16–18, *18*
- lysosomal-associated membrane proteins (LAMP) 152
- MAC *see* membrane attack complex
- Macfarlane, Frank 301
- macrophages
- adversarial strategies during infection 329, *329*, *334–338*, *335–337*
- allergy and other hypersensitivities 413
- anatomy of the immune response 182
- autoimmune diseases 517–519
- effectors 220, 224
- innate immunity 15, 16, 18–20, *19*, 29–30, 33–34
- specific acquired immunity 63, *64*
- tumor immunology 471–472, *473*, 475–476

- MAdCAM-1 170–171, 173
MAGE-1 479, 482
magnesium transporter protein-1 (MAGT1) 382
maintenance therapy 446
major basic protein (MBP) 413–414
major histocompatibility complex (MHC)
 adversarial strategies during
 infection 336–337, 340–341
 anatomy of the immune response 171, 182–183
 autoimmune diseases 500, 504–505, 509–513, 525
 birth and death evolution model 122, 123
 class I molecules 120–122
 class II molecules 122
 class III molecules 122–123
 cross-presentation of antigens 154, 155
 extracellular antigen processing for
 presentation by MHC II 151–152, 151, 153–154
 gene map 123–124, 124, 125
 H-2 haplotype 125, 126, 127
 historical milestones 120, 148–149
 immune response-related genes 122–123
 immunodeficiency 388–389
 inheritance of the MHC 126, 127, 127
 innate immunity 9, 13, 18, 42, 46–48
 intracellular antigen processing for
 presentation by MHC I 150–151, 151, 152
 lymphocyte activation 189–191, 205–206
 membrane-bound heterodimers 120–122, 121, 122
 membrane receptors for antigen 98–99, 102–105, 112–113, 115–129
 nonclassical MHC and class I chain-related molecules 127–128, 128
 nonclassical MHC as precursor to classical MHC 128–129
 ontogeny 299–300, 300, 300, 302–304, 309–311
 peptide-binding grooves 120–122, 154–156, 156–157, 157
 phylogeny 313
 polygenic molecules 122, 123
 polymorphism 125–126, 125
 regulation of immune response 273–276, 274, 275
 specific acquired immunity 53, 63–64
 ternary complex with peptide and T-cell receptors 156–157, 158–160
 tissue distribution 127
 transplantation 436, 438–444, 440–441, 444, 454
 tumor immunology 465, 470–471, 477–483
MALT *see* mucosa-associated lymphoid tissue
mannose-binding lectin (MBL) 40, 40, 384
Mantoux reaction 426, 426
marginal zone B-cells 207
mast cells
 allergy and other hypersensitivities 407–411, 408, 409
 innate immunity 15, 16, 19–20, 21
 types 408
maternal antibodies 419, 420
maternally acquired antibody 356, 356
MBD *see* methyl-CpG-binding domain proteins
MBL *see* mannose-binding lectin
MBP *see* major basic protein
M-cells 169–170, 172
MCP-1 *see* monocyte chemotactic protein-1
MDSC *see* myeloid-derived suppressor cells
Medawar, Peter 301, 437
membrane attack complex (MAC)
 adversarial strategies during
 infection 328, 329
 allergy and other hypersensitivities 418, 418
 immunodeficiency 384
 innate immunity 37, 37
 specific acquired immunity 54, 56, 57
membrane receptors for antigen
 activating and inhibitory NK
 receptors 115–119, 117, 118, 136
 antigens 97–138
 B-cell receptors 98–99, 98, 135
 concepts and definitions 98–99
 gene diversity for antigen
 recognition 108–113, 108, 136
 historical milestones 103–104, 120
 invariant natural killer T-cells 99, 113–115, 113, 114, 136
 lymphocyte activation 188–189
 major histocompatibility complex 98–99, 102–105, 112–113, 115–129, 136–137
 missing-self recognition 115, 116
 pattern recognition receptors 99, 113, 115, 129–135, 137
 T-cell receptors 98–99, 98, 102–108, 113–115, 136
memory cells
 antigen persistence and maintenance of
 memory 263–265
 asymmetric division 263, 264
 CD44 and Fas-dependent signals for
 apoptosis 265–266, 265
 effectors 262–267
 generation of memory 262–263, 263
 innate immunity 17
 maintenance of 266–267
 memory population and naive cells 265
 transplantation 437, 438
 vaccines 357
Mendelian susceptibility to mycobacterial
 disease (MSMD) 381
mesenchymal stem cells 292
messenger proteins 7–8, 8
metabolic control 202, 203
metabolic reprogramming 200–202, 201
metastatic potential 482–483
Metchnikoff, Elie 13–14
methicillin-resistant *Staphylococcus aureus*
 (MRSA) 322, 333
methyl-CpG-binding domain proteins
 (MBD) 199
MHC *see* major histocompatibility complex
MICA/MICB proteins
 anatomy of the immune response 171
 antigen-specific recognition 159–161
 membrane receptors for antigen 105, 117, 127–128
microbial antagonism 12
microbial vectors 360–361, 361
Miller, Jacques 296
missing-self recognition 115, 116
mixed lymphocyte reaction
 (MLR) 438–439
molecular mimicry 509–510, 510
monoclonal antibodies (mAb)
 allergy and other hypersensitivities
 412–413, 417
 antigen-specific recognition 147, 148
 autoimmune diseases 523–524, 524
 immunoglobulin G molecule 72
 transplantation 447–448, 448
 tumor immunology 483–486, 485
monocyte chemotactic protein-1
 (MCP-1) 21–22
mononuclear phagocyte system 29–30, 30
MRSA *see* methicillin-resistant *Staphylococcus aureus*
MS *see* multiple sclerosis
MSMD *see* Mendelian susceptibility to
 mycobacterial disease
mTOR (target of rapamycin) 446
mucosa-associated lymphoid tissue
 (MALT) 168, 169
mucosal immunity
 adversarial strategies during
 infection 332–333, 332
 anatomy of the immune response 169–
 171, 170
 gut-associated immunity 169–170, 172
 innate immunity 12, 12
 intestinal immunity 170–171, 173, 174
 lymphocytes 170–171, 173, 174
 M-cells and Peyer's patch
 epithelium 169–170, 172
multiple sclerosis (MS) 520–521
Murray, Joseph 437
myasthenia gravis 514
Mycobacterium spp. 337–338, 360
MyD88 *see* myeloid differentiation primary
 response protein
Myddosome 131–133, 134
myeloid cells 12–16, 14, 16

- myeloid-derived suppressor cells (MDSC) 285
 myeloid differentiation primary response protein (MyD88) 129, 130, 133, 134, 379
 myeloma proteins 72
- NA *see* neuraminidase
 NADP/NADPH *see* nicotinamide adenine dinucleotide phosphate
 natural cytotoxicity receptors 117
 natural killer (NK) cells
 abnormal host cells 42
 activating and inhibitory NK receptors 115–119, **117**, 118
 adversarial strategies during infection 336–337, 342–344
 allergy and other hypersensitivities 428
 CD16 Fc receptors 119
 CD94/NKG2 receptors 117
 cellular stress and DNA damage responses 119
 death receptor pathway 42, 43–44
 effectors 220, 255
 granule-dependent pathway 43
 granulysin-dependent pathway 255
 immunodeficiency 382
 innate immunity 9, 13, 18, 41–45
 interferons 44–45, 45
 invariant natural killer T-cell receptors 99, 113–115, 113, 114
 killer immunoglobulin-like receptors 116–117
 Ly49 receptors 116
 major histocompatibility complex 129
 natural cytotoxicity receptors 117
 ontogeny 298, 309–311, 311
 pathogen-associated molecular patterns 44
 specific acquired immunity 64, 64
 target cells 42–43, 43
 tumor immunology 465, 477, 489, 494
 naturally occurring Tregs (nTregs) 283, 284
 N-CAM 314–316
 NDP *see* dinitrophenyl
 necrosis 6, 6, 26–29
 Nef 398–399
Neisseria spp. 334, 366, 367
 neoantigens 459, 462, 463
 neonatal alloimmune thrombocytopenia 419
 neonatal Fc receptor 84–85, 84–85
 neonatal immunity 311–312, 312
 neonatal lupus erythematosus 516
 neonatal thyrotoxicosis 514, 515
 neovascularization 491
 nephrotoxicity 446
 NET *see* neutrophil extracellular traps
 network interactions 240, 241
 neuraminidase (NA) 339
 neuroectodermal tumors 463
 neuroendocrine networks 285–287, 286
 neutrophil extracellular traps (NET) 33–34, 34, 324, 325
 neutrophils
 adversarial strategies during infection 324, 332
 effectors 220, 245
 innate immunity 13, 15–16, 17, 20–22, 22, 29–30, 30, 32, 33–34
 tumor immunology 476–477, 477
 NFAT *see* nuclear factor of activated T-cells
 NFκB *see* nuclear factor κB
 nicotinamide adenine dinucleotide phosphate (NADP/NADPH) 30–32, 379, 380
 Nijmegen breakage syndrome 389
Nippostrongylus brasiliensis 345, 347
 NK *see* natural killer
 NKG2 receptors 117
 NLR *see* NOD-like receptors
 N-nucleotides 90
 NOD-like receptors (NLR) 25
 nonsteroidal anti-inflammatory drugs (NSAID) 522–523
 nTregs *see* naturally occurring Tregs
 nuclear factor of activated T-cells (NFAT) 197, 446
 nuclear factor κB (NFκB)
 lymphocyte activation 194–195, 197
 signal transduction cascades 237–240, 239
 tumor immunology 474
- Occam's razor 103
 occupational asthma 411
 oligoadenylate synthetase 41
 omega-3 fatty acids 287
 Omenn syndrome 388
 oncogenes 461, 474–475, 475, 480–481
 oncofetal antigens 482
 ontogeny 291–312
 antigen-dependent and -independent differentiation of lymphocytes 309, 310
 B-1 and B-2 cells as distinct populations 305, 307, 316
 B-cell differentiation in fetal liver and bone marrow 304–305, 316
 CD antigens 292, **293**
 concepts and definitions 292
 development of αβ receptors 298–299
 development of B-cell specificity 305–307, 308, 316–317
 development of γδ receptors 299
 differentiation and surface marker changes 295–298, 296, 297
 hematopoietic stem cells 292, 294, 316
 historical milestones 296, 301
 immunological tolerance 300–304, 307–309, 316–317
 natural killer cells 309–311, 311, 317
 neonatal immunity 311–312, 312, 317
 NKT cells as subset of αβT-cells 298
- positive selection in thymus for self-MHC recognition 299–300, 300, **300**
 thymus-dependent T-cell development 292–295, 295
 T-lymphocytes 292–304, 316
 opsonins/opsonization
 adversarial strategies during infection 329–332, 331, 332
 historical milestones 330
 innate immunity 7, 19–20, 35
 specific acquired immunity 53
 organ-related bystander tolerance 526, 526
 Owen, John 301
 oxidative phosphorylation (OXPHOS) 200, 202
- p53 461–462, 465, 470, 474
 p55 399
 PAF *see* platelet-activating factor
 PAMP *see* pathogen-associated molecular patterns
 parasitic infections
 adversarial strategies during infection 344–349
 avoiding antigen recognition by the host 348–349, 348
 cell-mediated immunity 346–348, 347
 deviation of host immune response 349
 evasive strategies by the parasite 348–349
 host responses 344–348
 humoral immunity 345–346, 346
 immunopathology 349
 innate immunity 45
 organism diversity 344, 345
 resistance to effector mechanisms 348
 vaccines 368–370, 372
 paroxysmal nocturnal hemoglobinuria (PNH) 382–383, 385, 430
 passive immunotherapy 483–486
 passively acquired immunity 354–357
 Pasteur, Louis 354–355
 pathogen-associated molecular patterns (PAMP)
 adversarial strategies during infection 326
 effectors 219–221, 223–224
 immunodeficiency 379
 innate immunity 4, 5, 7–8, 10–11, 19, 20, 22–24, 30, 44, 45, 47
 lymphocyte activation 188, 191, 196
 membrane receptors for antigen 98–99, 113, 129–130
 phylogeny 312
 Toll-like receptors 129–130, 130
 tumor immunology 459, 466, 466, 468
 pathogen-driving selection 125
 pattern recognition receptors (PRR)
 adversarial strategies during infection 326, 329, 331, 343–344, 344
 allergy and other hypersensitivities 415

- pattern recognition receptors (PRR) (*cont'd*)
 classification 7, 22–29
 combinatorial PRR signaling 23
 C-type lectin receptors detect fungal antigen 134–135
 cytokine and chemokine patterns 10
 decoding nature of infection 23
 dectin-1 detects fungal glucans 135, 135
 downstream responses to pattern recognition 7
 effectors 219–221
 first line of detection for microbial antigen 129–135
 immunodeficiency 379
 innate immunity 4, 5, 7–12, 19, 22–29, 46–48
 membrane receptors for antigen 99, 113, 115, 129–135
 messenger proteins 7–8, 8
 molecular fingerprint of pathogens 10
 phylogeny 312
 recognition and activation by PAMPs 22–23
 specificity of response to infection type 9–12
 Toll-like receptors 129–134, 130
 tumor immunology 459, 468
- Pax5 305
 PBSC *see* peripheral blood stem cells
 PD-1 *see* programmed death-1
 PDE *see* phosphodiesterase
 pemphigus foliaceus 516
 pemphigus vulgaris 516
 penicillins 412, 413
 pentraxins 39–40
 peptide-binding groove
 antigen-specific recognition 154–156, 156–157, 157
 lymphocyte activation 189
 membrane receptors for antigen 120–122
 peptide loading complex (PLC) 151
 perforin/granzyme-dependent pathway 43, 252–253, 252, 253
 peripheral blood stem cells (PBSC) 453
 peripherally derived Tregs (pTregs) 249
 peripheral supramolecular activation complex (pSMAC) 214
 peripheral tolerance 304
 pernicious anemia 515
 PERV *see* porcine endogenous retroviruses
 Peyer's patches 169–170, 172
 PGE₂ *see* prostaglandin E₂
 phagocytic cell defects 379–381, 380, 380, 381
 phagocytosis
 adversarial strategies during infection 326, 327, 329–331, 334–335, 335, 343
 complement facilitated phagocytosis and bacterial lysis 34–38
 cytotoxic T-lymphocytes 254–255, 255
 historical milestones 13–14
 innate immunity 7, 9, 22–23, 29–38
 killing mechanisms 30–34, 31–34
 macrophages and neutrophils 29–30, 30
 pattern recognition receptors 22–23
 specific acquired immunity 53, 55, 57
 phosphatidylinositol 3-kinase (PI3K) 196
 phosphatidylinositol pathway 194–196, 195
 phosphodiesterase (PDE) inhibitors 418
 phylogeny
 adaptive immunity in vertebrates 313
 cellular recognition of immunoglobulin gene superfamily 314–316, 315
 concepts and definitions 292, 317
 defenses against infection in plants 312–313, 312
 differentiation of B-cell and T-cell lineages 314, 314
 earliest defenses 312
 evolution of immune response 312–313
 invertebrate microbial defense mechanisms 313
 PI3K *see* phosphatidylinositol 3-kinase
 PIAS *see* protein inhibitor of activated STAT
 PID *see* primary immunodeficiency diseases
 piggy-back T-cell epitopes 510, 516
 PKR *see* protein kinase R
 plasma cell migration 257–258
 plasma cell survival 258
Plasmodium spp. 349, 363, 368–370
 platelet-activating factor (PAF) 323–325, 324
 platelet aggregation 421, 422, 441, 442
 PLC *see* peptide loading complex
 pleiotropy 240, 240
 PMN *see* polymorphonuclear neutrophils
 PNH *see* paroxysmal nocturnal hemoglobinuria
 P-nucleotides 90
 polyclonal activation 510–511
 polymorphic HLA 444, 444
 polymorphic MHC 125–126, 125
 polymorphonuclear neutrophils (PMN) 15, 30, 30
 polyunsaturated fatty acids (PUFA) 287
 pooled normal immunoglobulin 525
 porcine endogenous retroviruses (PERV) 449
 Porter, Rodney 71
 pregnancy 505–506
 premature cellular senescence 464, 474
 primary B-cell deficiency 386–387, 386, 387
 primary biliary cirrhosis 500
 primary immunodeficiency diseases (PID) 379, 382, 383
 primary T-cell deficiency 387–389, 388
 prions 349
 progenitor cells 15
 programmed death-1 (PD-1)
 lymphocyte activation 204–205
 tumor immunology 459, 468–470, 469, 487–488
 proliferative senescence 465
 prostaglandin E₂ 326
 protein-calorie malnutrition 287
 protein inhibitor of activated STAT (PIAS) family 236
 protein kinase R (PKR) 41
 protein kinases 188, 194–195
 protein-protein interactions 146
 protein tyrosine phosphorylation 192, 193
 proteinuria 425, 425
 proteolysis 241–242
 P-selectins 20, 323–324
 pSMAC *see* peripheral supramolecular activation complex
 psoriasis 429, 522
 psychoimmunology 286–287
 pTregs *see* peripherally derived Tregs
 PUFA *see* polyunsaturated fatty acids
 purine nucleoside phosphorylase 388
 pyrogenic toxins 162
- RA *see* rheumatoid arthritis
 radioimmunoconjugates 485–486
 Raf 192–194
 RAG *see* recombination-activating genes
 Ras 474–475, 475
 Ras-MAP kinase pathway 192–194, 194
 reactive arthritis 519
 reactive nitrogen intermediates 32
 reactive oxygen intermediates (ROI) 30–32, 33, 518–519
 receptor editing 109–111, 110
 recombinant DNA technology 72, 360
 recombinase machinery 90, 91
 recombination-activating genes (RAG 1/2) 90–91, 91, 111
 recombination signal sequences (RSS) 90, 90, 110–111, 110
 regulation of immune response 272–290
 activation-induced cell death 277–278, 279, 280, 289
 antibodies 273, 274, 276–277, 277, 289
 antigenic competition 276, 276, 289
 antigens 273–276, 273
 CD28 superfamily members 279, 280, 289
 complement 276–277, 277, 289
 concepts and definitions 273
 dietary effects on immunity 287, 289
 gender and aging 287–288, 288, 289–290
 H-2 haplotype 274
 idiotype networks 277, 278
 immunogenetics 273–276, 274–276, 289
 immunoneuroendocrine networks 285–287, 286, 289
 major histocompatibility complex 273–276, 274, 275
 T-lymphocytes 274–276, 281–289, 281–285
 regulatory T-cells (Treg) autoimmune diseases 511, 512–513

- CD4+ and CD8+ T-cell suppression of immune response 282–283, 282, 283
- DC subset cytotoxicity 250–251
- diversity of suppressor/regulatory cells 284–285, 284, 285
- lymphocyte activation 196, 198, 203
- mechanisms of action 249–250
- naturally occurring and inducible Tregs 283, 284
- peripherally derived Tregs 249
- policing adaptive immunity 222, 248–251, 248, 250
- regulation of immune response 281–285
- T-cell-mediated suppression 281–283, 282
- TC-independent role in promoting tissue repair 250, 250
- thymus-derived Tregs 248–249
- tumor immunology 470, 492–493
- repertoire diversification 93, 93
- restriction factors 339
- Rev 398
- Rhesus blood groups 419, 420
- rheumatoid arthritis (RA) 505–506, 517–519, 518
- rhinovirus 340
- RIG-I-like helicase receptors (RLR) 25, 28
- RNA vaccines 363–365, 365
- ROI *see* reactive oxygen intermediates
- Roryt 198
- Rosenthal, Alan 149
- Roux, Emile 330
- RSS *see* recombination signal sequences
- S1P *see* sphingosine 1-phosphate
- Salmonella* spp. 334, 360–361
- SAR *see* systemic acquired resistance
- sarcoidosis 428
- sarcomas 463
- SARS *see* severe acute respiratory syndrome
- scavenger receptors 26
- Schistosoma mansoni* 348
- SCID *see* severe combined immunodeficiency
- scleroderma 521
- SEA/SEB *see* *Staphylococcus aureus* enterotoxins
- secondary immunodeficiencies 379, 391–392
- secretory IgA 85–86, 87
- selective IgA deficiency 386–387
- self-association 517–518, 518
- senescence 464–465, 474
- sepsis 430
- SEREX *see* serological analysis of recombinant cDNA expression libraries
- serial TCR engagement model 206, 206
- serological analysis of recombinant cDNA expression libraries (SEREX) 479, 480
- severe acute respiratory syndrome (SARS) 338–339
- severe combined immunodeficiency (SCID) 105–106, 389–391, 390, 453
- Shevach, Ethan 149
- signal transduction cascades
- cytokines 234–240
 - granulocyte–macrophage colony-stimulating factor 237, 237, 238
 - JAK–STAT pathway 235–237, 235, 242
 - nuclear factor κ B pathway 237–240, 239
 - tumor necrosis factor 239–240
- silent genes 482
- simian immunodeficiency virus (SIV) 365, 393
- single-positive (SP) cells 297
- SIV *see* simian immunodeficiency virus
- skin immunity 12, 12, 168–169, 169, 170
- SLE *see* systemic lupus erythematosus
- SLIT *see* sublingual allergen immunotherapy
- Snell, George 120
- SOCS *see* suppressor of cytokine signaling
- solid organ allografts 419–420
- soluble pattern recognition molecules 38
- somatic hypermutation
- antibodies 91–92
 - effectors 257
 - membrane receptors for antigen 111–113, 112
- somatic recombination 86–87
- SP *see* single-positive
- specific acquired immunity 52–68
- adversarial strategies during infection 351
 - alternative and lectin complement pathways 55, 55, 57
 - antibodies and antigen recognition 53–56, 53, 66–67
 - antigens 53, 66
 - antigen specificity 61–62, 66, 67
 - cell-mediated immunity 62–68, 67
 - classical complement pathway 54–55, 54, 55
 - clonal selection 56–58, 59, 61
 - concepts and definitions 53
 - historical milestones 61
 - humoral immunity 56–58
 - immunological memory 58, 60, 62, 67
 - immunopathology 66, 66
 - integration of immune response 65, 66
 - intracellular pathogens 62–66
 - lymphocytes 56, 59
 - phagocytosis 53, 55, 57
 - primary and secondary response 58, 62
 - summary 66–68
 - vaccines 62, 63, 67
- specificity
- adversarial strategies during infection 342
 - antigens 61–62, 66, 67
 - antigen-specific recognition 148
 - cytokines 236–237
 - development of B-cell specificity 305–307
 - innate immunity 8–11, 49
 - pattern recognition receptors 9–12
 - transplantation 437, 438
 - tumor immunology 481
- sphingosine 1-phosphate (S1P) 175–177
- spleen 174–175, 180, 181
- Staphylococcus aureus* 333
- Staphylococcus aureus* enterotoxins (SEA/SEB) 162, 163
- stem cell therapy 449–450, 450, 451
- sterile injury 28–29
- stiff man syndrome 520
- stimulator of interferon genes (STING) 26, 29
- stimulatory hypersensitivity *see* Type V hypersensitivity
- STING *see* stimulator of interferon genes
- stochastic/selection hypothesis 298
- Streptococcus* spp. 333, 507
- sublingual allergen immunotherapy (SLIT) 417
- subunit vaccines 362–365, 362, 491–492, 491
- superantigens 162–163, 163, 430, 509
- suppressor of cytokine signaling (SOCS) family 236, 242
- systemic acquired resistance (SAR) 313
- systemic lupus erythematosus (SLE) 384, 425, 425, 500, 505–507, 505, 516–517, 517
- TAM *see* tumor-associated macrophages
- tapasin 151
- Tat 398–399
- T-bet 198–200
- TCA *see* tricarboxylic acid
- T-cell receptors (TCR)
- activating and inhibitory NK receptors 115–116
 - adversarial strategies during infection 337–338, 340
 - anatomy of the immune response 171
 - antigen-specific recognition 156–157, 158–160
 - CD3 complex 106–108, 107
 - CD4 and CD8 molecules as co-receptors 104, 105, 119–120
 - CD28 co-stimulation 195–197, 205
 - classification 104–105, 106
 - clustering leads to activation 188–189, 189, 190
 - damping T-cell enthusiasm 203–205, 204
 - downstream events following TCR signaling 192–195, 193
 - dynamic interactions at the immunological synapse 205–207
 - effectors 250, 255
 - encoding by gene segments 105–106, 106
 - gene expression signatures of activated T-cells 196–197
 - historical milestones 103–104
 - invariant natural killer T-cells 99, 113–115, 113, 114

- T-cell receptors (TCR) (*cont'd*)
- membrane receptors for antigen 98–99, 98, 102–108, 113–115
 - metabolic reprogramming 201–202
 - ontogeny 295–299, 302–304
 - phosphatidylinositol pathway 194–196, 195
 - phylogeny 313
 - Ras–MAP kinase pathway 192–194, 194
 - regulation of immune response 278
 - serial TCR engagement model 206, 206
 - somatic hypermutation 112
 - specific acquired immunity 53, 56–58, 60, 62, 64
 - surface transmembrane heterodimer 103
 - transplantation 441
 - triggering the T-cell receptor response 191, 192
 - tumor immunology 493–494
 - telomerase 266–267
 - telomere shortening 464–465
 - T follicular helper (T_{fh}) cells 244–246, 257
 - TGF receptors 234
 - T-helper cells
 - activated T-cell proliferation in response to cytokines 242, 243–247
 - acute inflammatory responses and neutrophil recruitment 245
 - allergy and other hypersensitivities 413–415, 414, 427–430, 430
 - antigen-specific recognition 149
 - autoimmune diseases 519–522
 - cell polarization 243–244, 243, 247–248
 - coordinated response to extracellular pathogens 244–245, 245
 - coordinated response to intracellular pathogens 244, 244
 - cross-regulation of Th1, Th2, and Th17 subsets 246, 246
 - effectors and adaptive immunity 222
 - formation and maintenance of germinal centers 245–246
 - immunodeficiency 394–395, 400, 402
 - innate immunity and T-helper cell response 247–248
 - lymphocyte activation 196–200, 208–209, 213–214, 213
 - regulation of immune response 281, 281, 286–287
 - specific acquired immunity 60, 62–64
 - stability versus plasticity of Th subsets 246–247
 - transplantation 440–441, 447–448
 - tumor immunology 466, 492–493
 - therapeutic cloning 450, 450
 - therapeutic immunoconjugates 485–486
 - thrombus formation 325
 - thymic stromal lymphopoietin (TSLP) 415
 - thymus
 - anatomy of the immune response 168, 174
 - bone marrow stem cells 295
 - cellular interactions in 294–295
 - historical milestones 296
 - immunodeficiency 387–388
 - intrathymic clonal deletion 302, 303
 - ontogeny 292–295, 295, 299–300
 - positive or negative selection 302–304
 - positive T-cell selection for self-MHC recognition 299–300, 300, 300
 - self-tolerance induction 301–302, 302
 - thymic hormones 293
 - thymus-dependent antigens 208–209, 209–211, 244–245, 245
 - thymus-derived Tregs (tTregs) 248–249
 - thyroid-stimulating hormone receptors (TSHR) 514, 515
 - thyroid-stimulating hormone (TSH) 430
 - TIR *see* Toll/IL-1R
 - tissue damage
 - allergy and other hypersensitivities 427–430
 - autoimmune diseases 518–519
 - effectors 250, 250
 - innate immunity 6, 6
 - tissue engineering 450, 451
 - TLR *see* Toll-like receptors
 - T-lymphocytes
 - activated T-cell proliferation in response to cytokines 242–247, 242, 244–246
 - adaptive immunity 11, 13, 16–18, 18, 46–48, 48
 - $\alpha\beta$ T-cell antigen recognition 156–157, 158–160, 163, 163
 - anatomy of the immune response 168–169, 177–178, 180–183
 - antigen-presenting cell interactions with accessory molecules 189–190, 189–191, 215
 - antigen-specific recognition 148–150, 156–163
 - autoimmune diseases 509–511, 509, 519–521
 - CD28 co-stimulation 195–197, 205
 - concepts and definitions 188
 - damping T-cell enthusiasm 203–205, 204
 - development of $\alpha\beta$ receptors 298–299
 - development of $\gamma\delta$ receptors 299
 - differentiation and surface marker changes 295–298, 296, 297
 - downstream events following TCR signaling 192–195, 193, 216
 - dynamic interactions at the immunological synapse 205–207
 - epigenetic control of T-cell activation 199–200, 200
 - $\gamma\delta$ T-cell antigen recognition 159–161
 - gene expression signatures of activated T-cells 196–199, 197
 - haplotype restriction 148–150
 - historical milestones 148–149, 209–210
 - immunodeficiency 387–389, 388, 394–395, 400–402
 - immunological tolerance 300–304, 309, 309–310
 - linear peptide sequence recognition 150, 150
 - lymphocyte activation 187–207, 215–216
 - memory cells 262–267
 - metabolic control of T-cell differentiation 202, 203
 - metabolic reprogramming 200–202, 201, 216
 - NKT cells as subset of $\alpha\beta$ T-cells 298
 - non-protein antigen recognition 158–159, 161–162
 - ontogeny 292–304
 - phosphatidylinositol pathway 194–196, 195
 - phylogeny 314
 - positive selection in thymus for self-MHC recognition 299–300, 300, 300
 - protein tyrosine phosphorylation 192, 193
 - Ras–MAP kinase pathway 192–194, 194
 - regulation of immune response 274–276, 281–288, 281–285
 - serial TCR engagement model 206, 206
 - specific acquired immunity 53, 56, 58, 62–66, 65
 - superantigens 162–163, 163
 - ternary complex with MHC and peptide 156–157, 158–160
 - thymus-dependent T-cell development 292–295, 295
 - transplantation 438–441, 440, 445–448, 445, 453–455
 - triggering the T-cell receptor response 191, 192
 - tumor immunology 468–471, 486–488, 492–494
 - two signal activation 191, 215–216
 - T–B collaboration for antibody production 208, 209–210
 - vaccines 357
 - TNF *see* tumor necrosis factor
 - TNF receptor-associated periodic syndrome (TRAPS) 381, 430
 - tolerance *see* immunological tolerance
 - Toll/IL-1R (TIR) signaling domain 129, 132–134
 - Toll-like receptors (TLR)
 - conserved microbial PAMP 129–130
 - immunodeficiency 379
 - innate immunity 23–24, 24–26, 24, 28–29
 - intracellular TLR signaling 132–134, 133
 - lymphocyte activation 207–208

- membrane receptors for antigen
129–134, 130
- MyD88 and TRIF form higher order complexes 134
- TLR2/1/6 132, 133
- TLR4/MD-2 complex detects microbial LPS 130–132, 131
- Tonegawa, Susumu 88
- toxic shock syndrome 430
- Toxoplasma* spp. 346, 348
- TRAM *see* TRIF-related adaptor molecule
- transcriptional programs 15
- transcription factors
lymphocyte activation 188, 194–195, 197–202, 197, 203
regulation of immune response 282–283, 282, 283
- transfusion reactions 418–419, 419
- transient hypogammaglobulinemia of infancy 387
- transplantation 435–457
antibodies 441, 442
clinical experience in grafting 450–454, 451, 452, 456
concepts and definitions 435
co-stimulatory blockade 447, 448
fetus as an allograft 454–455, 455, 456
genetic antigen control 437–438, 439, 455
graft types 436, **436**
graft-versus-host reaction 439, 440, 453
heart transplants 451, 452
hematopoietic stem cell grafts 452–453
historical milestones 437
HLA tissue typing 442–444, 444
immunological basis of graft rejection 66, 437, 455
immunosuppression 445–448, 445, 447, 456
inducing tolerance to graft antigens 447–448, 448
kidney grafts 450–451, 451, 452
liver transplants 451, 452
lymphocytes as mediators of rejection 439–440, 440
major histocompatibility complex 436, 438–441, 440–441, 454–455
matching donor and recipient 442–445
mechanisms of graft rejection 439–441, 455
memory and specificity 437, 438
mixed lymphocyte reaction 438–439
other organs and tissues 453–454
polymorphism of the human HLA system 444, 444
privileged sites 450
recognition of allogeneic MHC by recipient T-cells 440–441, 441
rejection types 436–437, **439**, 441
specific acquired immunity 66
stem cell therapy 449–450, 450, 451, 456
- supply versus demand 443
- therapeutic cloning 450, 450
- tissue engineering 450, 451
- value of matching tissue types 444–445
- xenografting 436, 449, 449, 456
- TRAPS *see* TNF receptor-associated periodic syndrome
- Treg *see* regulatory T-cells
- tricarboxylic acid (TCA) cycle 200–201, 201
- Trichinella spiralis* 345, 347
- TRIF-related adaptor molecule (TRAM) 133–134
- TRIM 399
- Trypanosoma* spp. 345–346, 348
- TSH *see* thyroid-stimulating hormone
- TSHR *see* thyroid-stimulating hormone receptors
- TSLP *see* thymic stromal lymphopoietin
- tTregs *see* thymus-derived Tregs
- tumor antigens 477–483
- tumor-associated macrophages (TAM) 471–472, 473, 475–476
- tumor immunology 458–498
adoptive cell transfer 492–493, 492
antibody-based targeting of cell surface tumor markers 484–485
antibody-mediated attack on tumor blood supply 486
antibody-mediated responses 466–467
antigen-independent cytokine therapy 488–489
approaches to cancer
immunotherapy 483, **484**, 496–497
cancer from the immune perspective 467–472, 496
cancer incidence and tissue type 462–463
cancer as spectrum of conditions 460–461, 461
cancer transformation as a multistep process 461–462, 461, 462
carbohydrate structure 482
cell-extrinsic mechanisms of tumor suppression 465–467, 466, 495–496
cell-intrinsic mechanisms of tumor suppression 464–465, 464, 495
cellular transformation and cancer 459–464, 495
checkpoint blockade
immunotherapy 487–488, 487
chimeric antigen receptor therapy 493–494
chronic inflammation 476–477, 476
classes of tumor antigens 480–483
concepts and definitions 458
cytotoxic T-lymphocytes 465–466
dendritic cell therapy 494–495, 495
DNA damage 460–461, 462, 473, 476–477, 476
driver mutations and passenger mutations 462, 463
- expression of normally silent genes 482
- ex vivo* expanded lymphocytes of dendritic cells 492–495
- growth factors and cell division 464
- historical milestones 481
- identification of tumor antigens 478–480, 478–480
- immunoediting and antigen loss 470–471, 471
- immunological escape mechanisms 467, 467
- immunosurveillance 465, 467–468, 470–471
- inflammatory response 471–477, 472, 486, 496
- lack of co-stimulation 468
- lack of PAMPs and nonself-determinants 468
- metastatic potential 482–483
- molecules that switch off T-cell responses 468–470, 469
- multiple strategies to evade and repel immune attack 467–468
- mutagenic agents 463–464
- mutations arising during cellular transformation 482
- natural killer cells 465, 494
- neoantigens 459, 462, 463
- oncogenic mutations 474–475, 475
- passive immunotherapy with monoclonal antibodies 483–486
- proinflammatory cytokines and chemokines 474–477, 475, 486
- sources of tumor-associated inflammation 474
- telomere shortening 464–465
- therapeutic immunoconjugates 485–486
- tolerization of T-cell responses 466, 468, 469
- transformed cells and multicellularity 460
- tumor antigens 477–483, 496
- tumor-associated macrophages 471–472, 473, 475–476
- tumor suppressor genes 461–462, 465
- unmasking latent T-cell responses 486–488
- vaccines 373, 489–492
- virally encoded antigens 480–482
- tumor necrosis factor (TNF)
adversarial strategies during infection 342–343, 349
autoimmune diseases 523–526
effectors 225, **227**, 228–229, 234, 239–242
immunodeficiency 381
innate immunity 42
regulation of immune response 278, 279
signal transduction cascades 239–240
tumor immunology 473–474

- tumor suppressor genes 461–462, 465
 twin studies 506
 type 1 diabetes 519–520, 520
 type 1 thymus-independent antigens 207–208, 208
 type 2 thymus-independent antigens 208, 208
 Type I hypersensitivity 356, 407–418, 431–432
 Type II hypersensitivity 356, 418–421, 432
 Type III hypersensitivity 421–426
 Type IV hypersensitivity 314, 426–430, 432
 Type V hypersensitivity 430
- ubiquitin ligases 205
 ulcerative colitis 428
 ultraviolet (UV) radiation 507
 urticarial reactions 412
- vaccines 353–377
 adaptive immunity 11
 adjuvants 373–375, 374, 376
 adoptive transfer of CTLs 357
 antibodies 354–357, 355
 approaches for generation of 359
 bioterrorism 372
 carbohydrate vaccines 363, 364
 classical methods of attenuation 358, 360
 concepts and definitions 354
 conditions for success of 358
 constraints on use of attenuated vaccines 361
 current vaccines 368, 369–371, 376
 DNA and RNA vaccines 363–365, 365
 herd immunity 357, 357
 historical milestones 354–355
 immunodeficiency 400–402, 400, 401
 intravenous immunoglobulin 356
 killed organisms as vaccines 357–358, 359, 375
 live attenuated organisms 358–362, 361, 375
 maternally acquired antibody 356, 356
- microbial vectors 360–361, 361
 neovascularization 491
 newer approaches to vaccine development 365–368, 366, 367, 375–376
 novel applications 373
 parasitic infections 368–370, 372
 passively acquired immunity 354–357, 375
 primary and secondary infections 357, 358
 principles of vaccination 357, 357, 375
 recombinant DNA technology 360
 specific acquired immunity 62, 63, 67
 subunit vaccines 362–365, 375, 491–492, 491
 tumor immunology 373, 489–492
 vaccines under development 368, 376
 veterinary applications 362
 viral antigens 489–490
 whole tumor cells 490–491, 490
- variant Creutzfeldt–Jakob disease (vCJD) 349
- vascular cell adhesion molecule (VCAM) 177, 191, 214
 vascular leak syndrome 486
 vascular permeability 18–19
 VCAM *see* vascular cell adhesion molecule
 vCJD *see* variant Creutzfeldt–Jakob disease
 V(D)J recombination
 antibodies 88–93, 89, 91–93
 autoimmune diseases 508
 immunodeficiency 390
 membrane receptors for antigen 108–109, 109
 ontogeny 305–307
 phylogeny 313
 transplantation 436
 veterinary vaccines 362
Vibrio cholerae 334
- viral infections
 adversarial strategies during infection 338–342
- antigenic drift and shift 339–340, 339
 antigen processing and/or presentation 340–341, 340
 cell-mediated immunity 341–342, 342, 343
 host counterattack against viruses 341–342, 342
 humoral immunity 341
 immune effector mechanisms 341
 immunodeficiency 391–392
 mechanisms of survival 338–339
 mutation produces nonfunctional T-cell epitopes 340
 tumor immunology 463–464
 vaccines 362
see also HIV/AIDS
- virally encoded antigens 480–482
 viral replication 41–42
 vitamins 287
 vitiligo 522
 von Behring, Emil 330
- Wegner's granulomatosis 521
 wheal and flare reaction 410, 411, 415
 WHIM syndrome 384
 Wiskott–Aldrich syndrome 389, 391
 wound healing 22, 473–474
 Wright, Almroth 330
- xenografting 436, 449, 449
 X-linked agammaglobulinemia (XLA) 386
 X-linked immunodeficiency syndromes 382, 383
 X-linked lymphoproliferative disease (XLP) 390
- Yersin, Alexandre 330
Yersinia spp. 334
- zidovudine (AZT) 399–400
 zinc deficiency 287
 Zinkernagel, Rolf 148–149

Index compiled by Manley Professional Indexing

WILEY END USER LICENSE AGREEMENT

Go to www.wiley.com/go/eula to access Wiley's ebook EULA.